



ACCELERATED MACHINING



General Catalog

2018 / 2019





In an accelerated world, a quick response to market needs is necessary. As a pioneer in innovation, **Tungaloy** leads the market in developing unique and powerful grades and geometries for this new era. TUNGFORCE, our newest line of products is designed for accelerated machining, bringing you the newest and greatest solutions for your machining needs.



2018 / 2019

full product line



Grade	A
Coated Grade CVD	A002
Coated Grade PVD	A003
Ceramic	A005
Cermet	A005
CBN (T-CBN)	A006
PCD (T-DIA)	A007
Uncoated Cemented Carbide	A007
TurnLine	B
Insert	B002
External Toolholder	B182
Internal Toolholder	B280
Miniature Machining	B348
Threading	B410
GrooveLine	C
Parting, Grooving, and Groove-Turn system	C002
MillLine	D
High-Feed Milling	D002
Shoulder Milling	D032
Face Milling	D096
Slot Milling	D126
Profile Milling	D140
Multi-Functional Milling	D168
Milling Insert	D212
DrillLine	E
2 Effective Drill	E004
Indexable Drill	E066
Deep Hole Drill	E096
ToolLine	F
Tooling System	F002
User's Guide	G
Parts for Tool	G002
Technical Reference	G029
Alphanumeric Index	G084

Introduction

■ Icons along the right/left side of the page

Turning



Ext. toolholder

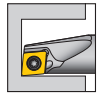

Int. toolholder



Miniature tool



Threading tool

Grooving, turning, and parting-off



Grooving, turning, and parting-off tool



Ext. grooving



Int. grooving



Face grooving



Parting-off

Milling



High-feed milling

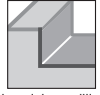

Shoulder milling



Face milling



Slot milling

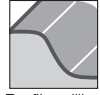

Profile milling



Multi-functional milling

Drilling



2-effective drill

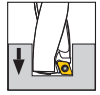

Indexable drill



Deep hole drill

Tooling system



Tooling system

■ Icons in the chart section for each product

Threading



Ext. threading

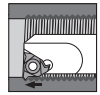

Int. threading

Grooving



Ext. grooving

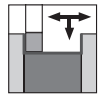

Ext. grooving and turning



Ext. grooving (full R)



Ext. grooving and turning (full R)

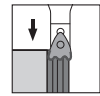

Forming



Int. grooving



Int. grooving and turning



Int. grooving and turning (full R)



Int. grooving (full R)



Parting-off



Face grooving

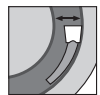

Face grooving and turning



Int. face grooving



Int. face grooving and turning

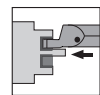

Face grooving for shaft

Milling



Shoulder milling



Deep shoulder milling



Shoulder milling (with radius)



Face milling

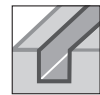

Slotting



Slotting (with radius)



Side slotting



Side milling



Pocketing



Ramping



Profiling

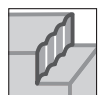

Plunging



Hole enlarging



Holemaking



Counterboring



Hole chamfering



Chamfering



Cutting-off

Drilling



Drilling

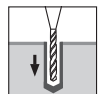

Small-diameter drilling



Deep-hole drilling



Hole chamfering



Tool kit



Oil hole



Oil hole for high-pressure

Introduction

■ Note in using this catalog:

- ★ This catalog provides the information of Tungaloy's cutting tools as of September 2017.
- ★ The specifications are subject to change without prior notice for product improvements. Also, the products may be discontinued in the future due to the development of new products.
- ★ The dimensions of all products are shown in inch (in) and millimeters (mm) where applicable.
- ★ For indexable tools, such as toolholders, cutters, drill bodies, applicable inserts or heads need to be ordered separately.

■ How to find a tool:

- ★ The catalog classifies the cutting tools into 5 lines – TurnLine (turning tools), GrooveLine (grooving tools), MillLine (milling tools), DrillLine (drilling tools), and ToolLine (tooling systems). The tools in each line are categorized by the applications.

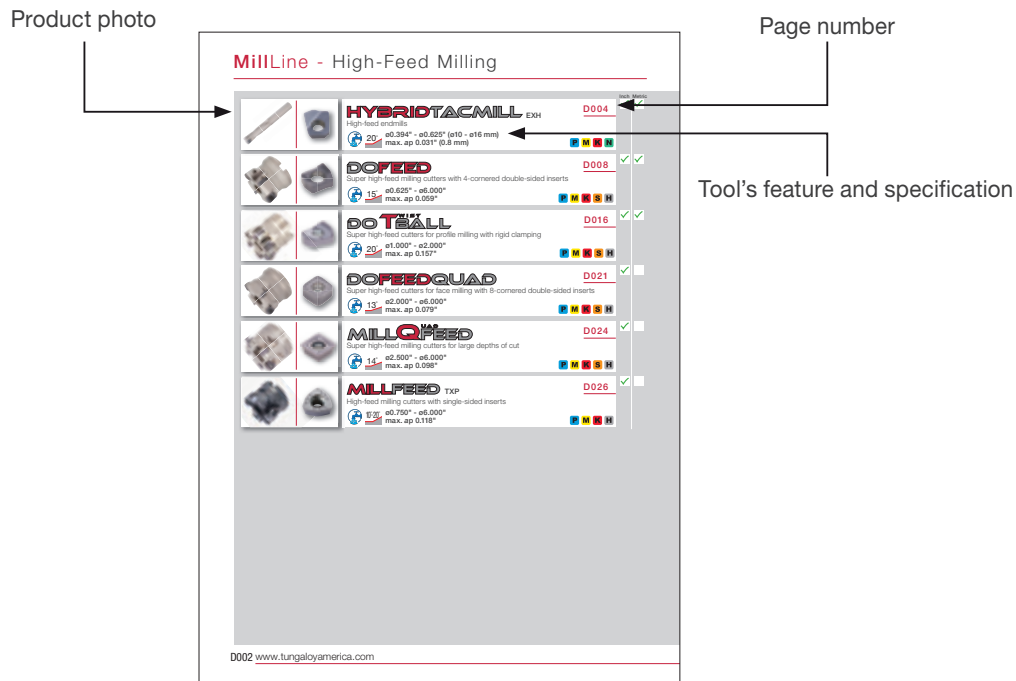

Example: Contents of the cutters for high-feed milling in MillLine

- ★ Alphanumeric index in User's Guide helps you search a specific product.

■ How to read the list for the standard items:

- ★ Designations for indexable tools – toolholders, cutters, drill bodies, etc.
 - Orders are to be received for the tools with the designations in the catalog.
 - For the tool with right- and left-hand options, the designation includes ****R/L**** as shown below.

Ex. 1: Designation: A12-SCLCR/L3-D16

You can order both right- and left-hand tools. A12-SCLCR3-D16 (a right-hand tool) and A12-SCLCL3-D16 (a left-hand tool) will be available.

Ex. 2: Designation: E10-SCLCR3-D14

You can order only right-hand tools. Please contact us when you need left-hand tools.

- ★ Line-up for inserts and solid tools
 - Blank : Please contact us regarding the product.

Grade

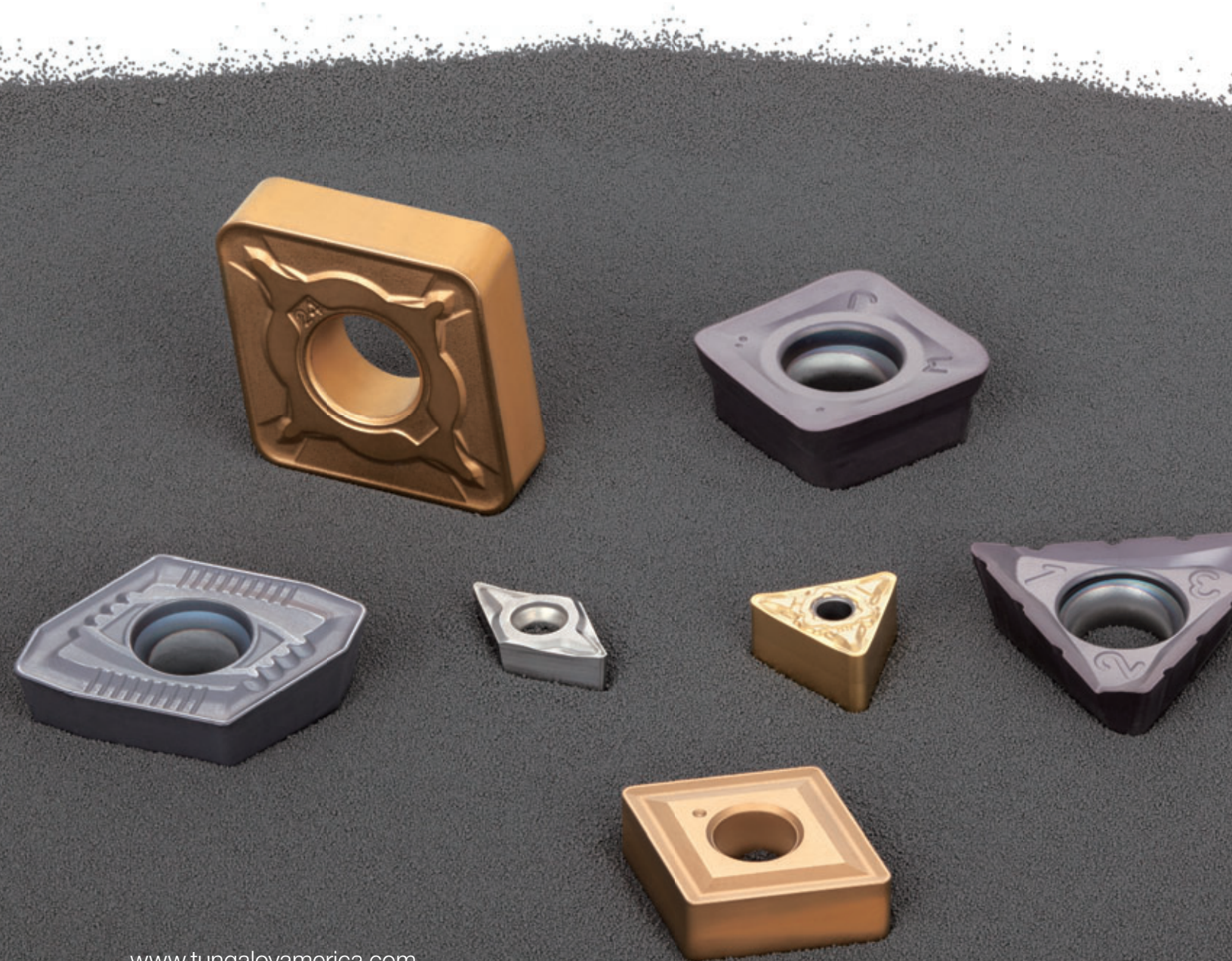

GRADE



Coated Grade CVD A002

Coated Grade PVD A003

Ceramic A005

Cermet A005

CBN (T-CBN) A006

PCD (T-DIA) A007

Uncoated Cemented Carbide A007

CVD - Coated Grade

Grade	Coating		Application	Feature	Turning	Grooving	Milling	Drilling
	Main composition	Thickness / μm						
T9105 P01 - P10 K10 - K20	TiCN-Al ₂ O ₃	16	P K	- Good wear resistance - Excellent performance in high-speed cutting				
T9115 P10 - P20 K15 - K30	TiCN-Al ₂ O ₃	16	P K	- Well-balanced between wear and chipping resistance - Suitable for a wide range of turning applications				
T9125 P20 - P30	TiCN-Al ₂ O ₃	16	P	- High chipping resistance in light to medium interrupted cutting - First choice for machining steel				
T9135 P30 - P40	TiCN-Al ₂ O ₃	16	P	- Excellent fracture resistance in heavy interrupted cutting				
T6120 P10 - P20 M10 - M20	TiCN	6	P M	- Good wear resistance in continuous cutting at high speed				
T6130 P15 - P30 M15 - M30	TiCN	6	P M	- High wear resistance in cutting at medium to high speed - First choice for machining stainless steel				
T515 K10 - K20	TiCN-Al ₂ O ₃	16	K	- Good wear resistance even in high-speed machining - First choice for roughing cast iron				
T5105 K05 - K15	TiCN-Al ₂ O ₃	16	K	- High resistance to wear and plastic deformation in continuous cutting at high speed				
T5115 K10 - K20	TiCN-Al ₂ O ₃	16	K	- Stable machining in a wide range of applications from continuous to interrupted cutting				
T5125 K15 - K30	TiCN-Al ₂ O ₃	16	K	- Strong resistance to sudden fracture - Ideal for heavy interrupted machining				
T313V -	TiCN-Al ₂ O ₃	3	Threading	- Good resistance to plastic deformation - Designed for threading				
T3225 P20 - P35 M20 - M35	TiCN-Al ₂ O ₃	10	P M	- High chipping and fracture resistance - Suitable for machining steel and stainless steel				
T3130 P20 - P40 M20 - M40	TiCN-Al ₂ O ₃	6	P M	- Good balance between wear and chipping resistance - Ideal for machining steel and stainless steel				
T1215 K10 - K25	TiCN-Al ₂ O ₃	10	K	- Good balance between wear and chipping resistance - Designed for machining cast iron				
T1115 K10 - K25	TiCN-Al ₂ O ₃	11	K	- High wear resistance - Ideal for machining cast iron				

PVD - Coated Grade

Grade	Coating		Application	Feature	Turning	Grooving	Milling	Drilling
	Main composition	Thickness / μm						
AH110 P05 - P15 M05 - M15 K10 - K25 S05 - S15	(Ti, Al)N	3	P M K S	- High wear resistance - Suitable for finishing steel, cast iron, and high-hardened material	█	█	█	█
AH120 P15 - P25 M15 - M25 K15 - K30 S10 - S25	(Ti, Al)N	3	P M K S	- Good balance between wear and fracture resistance - Suitable for machining steel, stainless steel, cast iron, and super alloys under general cutting conditions	█	█	█	█
AH130 P25 - P40 M25 - M40	(Ti, Al)N	3	P M	- High chipping and fracture resistance - Designed for machining austenitic stainless steel under general cutting conditions	█	█	█	█
AH140 M30 - M45	(Ti, Al)N	3	M	- High fracture resistance - Suitable for machining stainless steel	█	█	█	█
AH170 P20 - P35 M20 - M35 K15 - K30	(Ti, Al)N	3	P M K	- High wear resistance - Suitable for steel and cast iron drilling	█	█	█	█
AH180 P20 - P35 M20 - M35 K15 - K30	(Ti, Al)N	3	P M K	- High wear resistance - Suitable for steel, cast iron and stainless drilling	█	█	█	█
AH330 P15 - P30	(Ti, Al)N	3	P	- Excellent wear resistance	█	█	█	█
AH630 P15 - P30 M15 - M30	(Ti, Al)N	5	P M	- Good resistance to wear and fracture in machining stainless steel at low to medium cutting speed	█	█	█	█
AH645 P30 - P40 M30 - M40	(Ti, Al)N	5	P M	- High fracture resistance in machining stainless steel	█	█	█	█
AH710 P05 - P15 K05 - K15 H05 - H15	(Ti, Al)N	3	P K H	- High wear resistance - Ideal for finishing steel, cast iron and high-hardened material	█	█	█	█
AH725 P15 - P30 M15 - M30 K25 - K30 S15 - S25	(Ti, Al)N	2	P M K S	- Good balance between wear and chipping resistance - Suitable for machining steel and stainless steel under general cutting conditions	█	█	█	█
AH7025 P20 - P30 M20 - M30 S15 - S25	(Ti, Al)N	3.5	P M S	- Excellent wear resistance and high rigidity - First choice for grooving of various materials	█	█	█	█
AH730 P15 - P30	(Ti, Al)N	3	P	- Well-balanced between wear and fracture resistance	█	█	█	█
AH740 P25 - P40	(Ti, Al)N	3	P	- Excellent chipping resistance in machining steel	█	█	█	█
AH750 H15 - H30	(Ti, Al)N	3	H	- High wear resistance - Suitable for hard material machining	█	█	█	█
AH8005 M01 - M10 S01 - S10	(Al,Ti)N	3.5	M S	- Good balance between wear and fracture resistance - First choice for machining heat-resistant alloys under general cutting conditions	█	█	█	█
AH8015 M10 - M20 S10 - S20	(Al,Ti)N	3.5	M S H	- Strong resistance to wear and built-up edge	█	█	█	█
AH905 S01 - S10	(Al, Ti)N	1.5	S	- Strong resistance to wear and built-up edge	█	█	█	█

PVD - Coated Grade

Grade	Coating		Application	Feature	Turning	Grooving	Milling	Drilling
	Main composition	Thickness / μm						
AH3035 P20 - P45 H20 - H30	(Ti, Al)N	5	P H	- Good balance between wear and chipping resistance - Suitable for machining high-hardened material at high feed				
AH3135 P30 - P40 M30 - M40	(Ti, Al)N	4	P M	- High fracture resistance - Ideal for machining steel and stainless steel under general cutting conditions				
AH4035 M30 - M45	(Ti, Al)N	5	M	- Good balance for wear and fracture resistance - Suitable for difficult stainless steel machining				
AH6030 M25 - M35 S15 - S30	(Ti, Al)N	5	M S	- High fracture resistance - Ideal for drilling stainless steel and heat-resistant alloys under general cutting conditions				
AH9030 P15 - 35 K10 - 25	(Ti, Al)N	5	P K	- High wear resistance - Designed for drilling steel and cast iron at high speed				
SH725 P20 - P30 M20 - M30	(Ti, Al)N	2	P M	- Excellent wear resistance - Suitable for machining steel and stainless steel				
SH730 P20 - P35 M20 - M35 S05 - S15	(Ti, Al)N	1	P M S	- High wear resistance - Suitable for machining steel, stainless steel, and difficult-to-cut materials				
GH110 K10 - K25 N05 - N15	Ti(C, N, O)	3	K N	- Good wear resistance				
GH130 P25 - P40 M25 - M40 K25 - K40	Ti(C, N, O)	3	P M K	- High chipping and fracture resistance - Suitable for machining steel, stainless steel and cast iron				
GH330 P15 - P30 M15 - M30 K05 - K30	Ti(C, N, O)	3	P M K	- Strong resistance to wear and fracture - Suitable for continuous to medium interrupted cutting				
GH730 P20 - P35 M20 - M35 K20 - K30	Ti(C, N, O)	3	P M K	- High wear resistance - Ideal for turning and grooving at low speed				
J740 -	TiN	1	For small lathes	- Ultra-fine-grain cemented carbide coated with TiN-based compound				
YH170 P20 - P35 M20 - M35	Ti(C, N)	1.5	P M	- Strong resistance to wear and fracture - Suitable for steel and stainless drilling				
YH180 P20 - P35 M20 - M35	Ti(C, N)	1.5	P M	- High wear resistance - Suitable for steel and stainless drilling				
JM10 P20 - P35 M20 - M35	TiN	1	P M	- High wear resistance - Suitable for steel and stainless drilling				
DS1100 N05 - N20	DLC coating	Thin layer	N	- High wear resistance - Designed for finishing aluminum				
DS1200 N10 - N25	DLC coating	Thin layer	N	- Good balance between wear and chipping resistance - Ideal for semi-finishing to finishing of aluminum				

Ceramic

Grade	Specific gravity	Hardness (HRA)	T.R.S. (GPa)	Application	Feature				
						Turning	Grooving	Milling	Drilling
LX11	4.35	94.0	0.9	H	- Alumina base - Suitable for continuous cutting of high-hardened materials				
LX21	4.24	94.0	0.8	K	- Alumina base - Excellent chipping resistance in continuous cutting of cast iron				
FX105	3.24	93.0	1.3	K	- Silicon nitride base - Suitable for high-speed machining of cast iron				
CX710	3.20	92.9	1.1	K	- Silicon nitride base - Excellent performance in high-speed machining of cast iron				

Cermet

Grade	Coating		Application	Feature				
	Main composition	Thickness / μm			Turning	Grooving	Milling	Drilling
GT9530	Ti(C, N, O)	3	P K	- High wear resistance - Ideal for finishing with high surface quality				
J9530	TiN	1	For small lathes	- Suitable for small-part machining				
NS9530	Uncoated	-	P K	- High fracture resistance - Suitable for finishing to medium cutting of steel				
NS740	Uncoated	-	P	- Good resistance to fracture and thermal crack - Ideal for milling operations that require high rigidity				
NS520	Uncoated	-	P K	- Good wear resistance				
GT720	Ti(C, N, O)	3	P K	- Good wear resistance in high speed machining				
X407	Uncoated	-	P	- Good wear resistance for finish on dry machining				
N308	Uncoated	-	P	- Good wear resistance				

CBN (T-CBN)

Grade	Hardness (Hv)	T.R.S. (GPa)	Application	Feature	Turning	Grooving	Milling	Drilling
BXA20	3300 ~ 3500	1.30 ~ 1.50	H	- Excellent performance in machining hardened steel				
BXM10	2700 ~ 2900	0.80 ~ 0.90	H	- Suitable for machining hardened steel with continuous cutting at high speed				
BXM20	3500 ~ 3700	1.35 ~ 1.50	H	- First choice for machining hardened steel in a wide range of applications				
BXC50	3500 ~ 3700	1.15 ~ 1.30	H	- High fracture resistance in continuous to interrupted machining				
BX310	2700 ~ 2900	0.80 ~ 0.90	H	- Good wear resistance - Designed for continuous cutting of hardened steel at high speed				
BX330	2800 ~ 3000	0.85 ~ 0.95	H	- Excellent sharpness - Designed for finishing hardened steel				
BX360	3200 ~ 3400	1.00 ~ 1.10	H	- Suitable for general-purpose machining of hardened steel				
BX380	3500 ~ 3700	1.15 ~ 1.30	H	- High fracture resistance - Suitable for heavy interrupted cutting of hardened steel				
BX530	2800 ~ 3000	0.85 ~ 0.95	H	- Suitable for finishing hardened steel with high surface quality				
BXC90 (BX90S)	3900 ~ 4100	1.80 ~ 1.90	K	- Suitable for machining cast iron at high speed				
BX910	2600 ~ 2800	0.80 ~ 0.90	K	- Excellent wear resistance in high-speed machining - Ideal for machining centrifugally cast iron				
BX930	3000 ~ 3200	0.95 ~ 1.20	K	- Designed for machining ductile cast iron				
BX950	3900 ~ 4100	1.80 ~ 1.90	K S	- High fracture resistance - Good performance in high-speed machining				
BX850	3300 ~ 3500	0.75 ~ 0.85	H	- Suitable for hardened steel ball end milling				
BX870	3000 ~ 3200	0.95 ~ 1.20	K	- High wear resistance - Suitable for machining cylinder liners made of cast iron				
BX470	4100 ~ 4300	1.90 ~ 2.10	Sintered metal	- Excellent sharpness - Suitable for machining ferrous sintered metal				
BX480	4100 ~ 4300	1.90 ~ 2.10	Sintered metal	- Hardest grade of all T-CBN grades - Suitable for machining ferrous sintered metal				
M714B	3000 ~ 3200	1.00 ~ 1.10	S	- High wear resistance and thermostability - Good performance in high-speed machining of Inconel				

PCD (T-DIA)

Grades	Grain size (µm)	Hardness (Hv)	T.R.S. (GPa)	Application	Feature	Turning	Grooving	Milling	Drilling
DX110	< 1	8500	1.8	N	- Excellent sharpness for high surface quality - Suitable for finishing non-ferrous metal and nonmetal				
DX120	4.5	9000	1.8	N	- Suitable for precision machining of non-ferrous metal and nonmetal				
DX140	12.5	10000	1.7	N	- High wear resistance - Suitable for machining non-ferrous metal and nonmetal				
DX160	28	11000	1.6	N	- Designed for machining ceramic, cemented carbide, and nonmetal				
DX180	45	12000	1.5	N	- High wear resistance - Designed for ceramic, cemented carbide, and nonmetal				

Uncoated Cemented Carbide

Grades	Specific gravity	Hardness (HRA)	T.R.S. (GPa)	Application	Turning	Grooving	Milling	Drilling
UX30 P30 M30	12.6	91.1	2.3	P M				
TH10 P10 M10 K10 N10	14.7	92.0	2.4	P M K N				
KS05F K05 S05 N05	15.0	93.0	2.9	K S N				
KS15F N15	14.4	91.5	3.0	N				
KS20 K20 N20 S20	14.5	90.8	2.8	K S N				
TH03 P05 M05 K05 N05	13.8	93.8	1.9	P M K N				
F	14.9	93.4	2.5	P K				
EM10 P10 - P25 K10 - K25	14	91.5	3.4	P K				

Grades	Specific gravity	Hardness (HRA)	T.R.S. (GPa)	Application	Turning	Grooving	Milling	Drilling
UM K10 - K25 N10 - N25	13.9	90.9	3.5	K N				
G2 K10 - K25 N10 - N25	15	90.8	2.7	K N				
G1F P10 - P25 K10 - K25	15.1	92	2.6	P K				
MD10 P10 - P25 M10 - M25	15	92.8	3.4	P M				
MD20 P20 - P35 M20 - M35	14.4	91.5	3.9	P M				

TurnLine



TURNING



Insert

B002



External Toolholder

B182



Internal Toolholder

B280



Miniature Machining



B348



Threading

B410

TurnLine - Insert

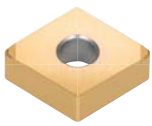
			Inch	Metric
	Negative type Coated grades CVD/PVD, Cermet, Uncoated cemented carbides, Ceramic	<u>B052</u>	✓	✓
	Positive type Coated grades CVD/PVD, Cermet, Uncoated cemented carbides, Ceramic	<u>B106</u>	✓	✓
	CBN/PCD Insert CBN (T-CBN), PCD (T-DIA)	<u>B160</u>	✓	✓



Tungaloy B003



TurnLine - Symbolization of Inserts

Symbol	Shape	Nose angle	Figure
H	Hexagonal	120°	
O	Octagonal	135°	
P	Pentagonal	108°	
S	Square	90°	
T	Triangular	60°	
C	Rhombic	80°	
D		55°	
E		75°	
F		50°	
M		86°	
V		35°	
Y	Y-Shape (Tungaloy Symbol)	25°	
W	Trigon	80°	
L	Rectangular	90°	
A	Parallelogram	85°	
B		82°	
K		55°	
R	Round	-	

Symbol	Relief angle
A	3°
B	5°
C	7°
D	15°
E	20°
F	25°
G	30°
N	0°
P	11°
O	Others

Symbol (class)	Tolerance (inch)		
	Cutting point	Thickness	Inscribed circle(d)
A	±0.0002	±0.0001	±0.0001
F	±0.0002	±0.0001	±0.0005
C	±0.0005	±0.0001	±0.0001
H	±0.0005	±0.0001	±0.0005
E	±0.001	±0.001	±0.001
G	±0.001	±0.005	±0.001
J	±0.0002	±0.001	±0.002~ ±0.005
K	±0.0005	±0.001	±0.002~ ±0.005
L	±0.001	±0.001	±0.002~ ±0.005
M	±0.003~ ±0.007	±0.005	±0.002~ ±0.005
N	±0.003~ ±0.007	±0.001	±0.002~ ±0.005
U	±0.005~ ±0.015	±0.005	±0.003~ ±0.01

With respect to the nose angles of rhombic and parallelogram shaped inserts, use the smaller nose angles.

(Example) ①



④ Chipbreaker and hole					
Symbol	Hole	Shape of hole	Chip-breaker	Shape of Insert's section	
N	Without	-	Without		
R			Single side		
F			Double sided		
A	With	Cylindrical hole	Without		
M			Single side		
G			Double sided		
W			Partly cylindrical hole, 40-60° counter sink	Without	
T				Single side	
Q				Double sided	
U	Partly cylindrical hole, 70-90° counter sink	Without	Without		
B			Single side		
H			Without		
C	Partly cylindrical hole, 70-90° counter sink	Without	Without		
J			Without		
X					

⑤ Size (I.C.)			
Symbol		Dimensions (in)	
Normal Series	Small Series	I.C.	Fraction
(1.2)	5	0.156	5/32
(1.5)	6	0.187	3/16
(1.8)	7	0.219	7/32
2	(8)	0.250	1/4
(2.5)	0	0.313	5/16
3	-	0.375	3/8
4	-	0.500	1/2
5	-	0.625	5/8
6	-	0.750	3/4
7	-	0.875	7/8
8	-	1.000	1
(10)	-	1.250	1-1/4

ANSI Designation



Insert

Detailed accuracy

Corner angles larger than 55°

Inscribed circle	Inscribed circle dimensional tolerance (in)		Tolerance of corner point (in)		Shape
	J,K,M,N (Class)	U (Class)	J,K,M,N (Class)	U (Class)	
0.250	±0.002	±0.003	±0.003	±0.005	H W
0.375					O R
0.500	±0.003	±0.005	±0.005	±0.008	P
0.625					S
0.750	±0.004	±0.007	±0.006	±0.010	T
1.000					C, E, M

Note on insert thickness

Thickness of insert with chipbreaker grooves is defined as shown to the right.

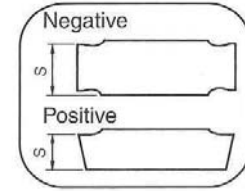

Corner angles at 55° (M-Class)

Inscribed circle	Inscribed circle dimensional tolerance (in)	Tolerance of corner point (in)	Shape
0.250	±0.002	±0.004	D
0.375			
0.500	±0.003	±0.006	D
0.625	±0.004	±0.007	
0.750			

Inscribed circle
Corner point (in)

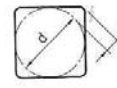
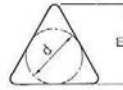

Symbol		Thickness (in)	
Normal Series	Small Series		
-	2	0.062	1/16
1.5	3	0.094	3/32
2	4	0.125	1/8
2.5	5	0.156	5/32
3	6	0.187	3/16
3.5	-	0.219	7/32
4	-	0.250	1/4
5	-	0.313	5/16
6	-	0.375	3/8

Thickness

Ⓣ Thickness

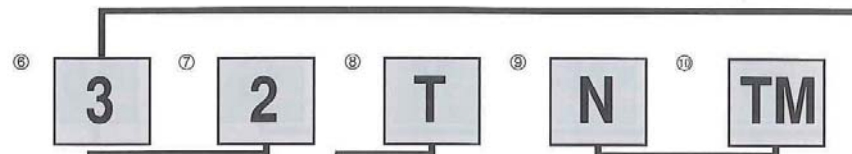

⑦ Corner radius

Symbol	Corner radius (in)
V	0.001 -
0	0.004 1/256
0.5	0.008 1/128
1	0.016 1/64
2	0.031 1/32
3	0.047 3/64
4	0.062 1/16
5	0.078 5/64
6	0.094 3/32
7	0.109 7/64
8	0.125 1/8

⑧ Symbols of major cutting edge

Symbol	Condition of cutting edge	Shape
F	Sharp edge	
E	Round honing edge	
T	Chamfering honing edge	
S	Combination honing edge	

⑨ and ⑩

Our company's own symbols showing cutting edge conditions. For details, refer to page B007.

Insert Hole Size Chart

Insert Hole Size		
	I.C.	Diameter
Negatives	1/4	0.089
	3/8	0.150
	1/2	0.203
	5/8	0.250
	3/4	0.312
	1	0.359
Positives	1 1/4	0.346
	5/32	0.087
	3/16	0.087
	13/64	0.110
	7/32	0.094
	1/4	0.110
	5/16	0.134
	3/8	0.173
1/2	0.217	
5/8	0.217	



TurnLine - Designation system for Insert

● Conforms to "Indexable Inserts for Cutting Tools - Designation" (JIS B4120-1998, and ISO 1832 / AM1-1998)

Symbol	Shape	Nose angle (degree)	Figure
H	Hexagonal	120°	
O	Octagonal	135°	
P	Pentagonal	108°	
S	Square	90°	
T	Triangular	60°	
C	Rhombic	80°	
D		55°	
E		75°	
F		50°	
G	G-shape (Tungaloy's symbol)	70°	
M	Rhombic	86°	
V		35°	
Y	Y-shape (Tungaloy's symbol)	25°	
W	Trigon	80°	
L	Rectangular	90°	
A	Parallelogram	85°	
B		82°	
K		55°	
R	Round	-	

1 Shape

Notes : With respect to the nose angles of rhombic and parallelogram shaped inserts, use the smaller angle respectively.

Symbol	Relief angle
A	3°
B	5°
C	7°
D	15°
E	20°
F	25°
G	30°
N	0°
P	11°
O	Others
X	Special



2 Relief angle

Symbol (class)	Tolerance (mm)		
	Corner height (m)	Thickness (s)	I. C. dia. (ød)
A	±0.005	±0.025	±0.025
F	±0.005	±0.025	±0.013
C	±0.013	±0.025	±0.025
H	±0.013	±0.025	±0.013
E	±0.025	±0.025	±0.025
G	±0.025	±0.13	±0.025
J	±0.005	±0.025	±0.005 ~ ±0.13
K	±0.013	±0.025	±0.05 ~ ±0.13
L	±0.025	±0.025	±0.05 ~ ±0.13
M	±0.08 ~ ±0.18	±0.13	±0.05 ~ ±0.13
N	±0.08 ~ ±0.18	±0.025	±0.05 ~ ±0.13
U	±0.13 ~ ±0.38	±0.13	±0.08 ~ ±0.25

3 Accuracy

1

T

1

2

N

2

3

M

3

4

G

4

5

16

5

1

C

1

2

C

2

3

G

3

4

T

4

5

09

5

4 Groove and hole					
Symbol	Hole	Shape of hole	Chip-breaker	Shape	
N	Without	-	Without		
R			Single-sided		
F			Double-sided		
A	With	Cylindrical hole	Without		
M			Single-sided		
G			Double-sided		
W			Partly cylindrical hole, single-side 40° ~ 60° Counter sink	Without	
T				Single-sided	
Q				Without	
U	Partly cylindrical hole, double-side 40° ~ 60° Counter sink	Double-sided			
B		Without			
H		Single-sided			
C	Partly cylindrical hole, double-side 70° ~ 90° Counter sink	Without			
J		Double-sided			
X	-	-	-		

5 Cutting edge length																
* (R)		(S)		(C)		(W)		(T)		(D)		(V)		(K)		I. C. dia. (mm)
Symbol	Length	Symbol	Length	Symbol	Length	Symbol	Length	Symbol	Length	Symbol	Length	Symbol	Length	Symbol	Length	
		03	3.97	03	4.0			06	6.9	04	4.8					3.97
		04	4.76	04	4.8			08	8.2	05	5.8	08	8.3			4.76
*05	5	-	-	-	-	-	-	-	-	-	-	-	-	-	-	5
		05	5.56	05	5.6	03	3.8	09	9.6	06	6.8					5.56
*06	6	-	-	-	-	-	-	-	-	-	-	-	-	-	-	6
		06	6.35	06	6.5	04	4.3	11	11	07	7.8	11	11.2			6.35
		07	7.94	08	8.1	05	5.4	13	13.8	09	9.7					7.94
*08	8	-	-	-	-	-	-	-	-	-	-	-	-	-	-	8
09	9.525	09	9.525	09	9.7	06	6.5	16	16.5	11	11.6	16	16.6	16	19.7	9.525
*10	10	-	-	-	-	-	-	-	-	-	-	-	-	-	-	10
*12	12	-	-	-	-	-	-	-	-	-	-	-	-	-	-	12
12	12.7	12	12.7	12	12.9	08	8.7	22	22	15	15.5	22	22.1			12.7
15	15.875	15	15.875	16	16.1	10	10.9	27	27.5	19	19.4					15.875
*16	16	-	-	-	-	-	-	-	-	-	-	-	-	-	-	16
19	19.05	19	19.05	19	19.3	13	13	33	33	23	23.3					19.05
*20	20	-	-	-	-	-	-	-	-	-	-	-	-	-	-	20
		22	22.225	22	22.6			38	38.5	27	27.1					22.225
*25	25	-	-	-	-	-	-	-	-	-	-	-	-	-	-	25
25	25.4	25	25.4	25	25.8			44	44	31	31					25.4
31	31.75	31	31.75	32	32.2			55	55	38	38.8					31.75
*32	32	-	-	-	-	-	-	-	-	-	-	-	-	-	-	32

* When M0 is included in Designation, the inscribed-circle diameter is metric size.

ISO Designation



Insert

● Detailed accuracy for J,K,L,M,N and U classes

For inserts with nose corner angles larger than 55°

Inscribed circle	Tolerance on inscribed circle dia. (ød)		Tolerance on corner height (m)		Insert shapes applied
	J,K,L,M,N (class)	U (class)	J,K,L,M,N (class)	U (class)	
6.35	±0.05	±0.08	±0.08	±0.13	H W
9.525					
12.7	±0.08	±0.13	±0.13	±0.2	O R
15.875					
19.05	±0.1	±0.18	±0.15	±0.27	P
25.4					
31.75	±0.13	±0.25	±0.18	±0.38	S
32					
					T
					C,E,M

Unit: mm

Note on insert thickness
With regard to the insert thickness for chipbreaker inserts, the thickness (s) drawn in the outlined insert shapes on pages XX to XX is defined as "s" (height from the bottom face to the cutting edge) shown in the figure at right.

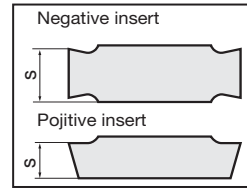

Symbol	Thickness (mm)
X1	1.39
O1	1.59
T1	1.98(1.79)
O2	2.38
T2	2.78
O3	3.18
T3	3.97
O4	4.76
O5	5.56
O6	6.35
O7	7.94
O9	9.52

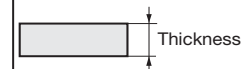

6 Thickness

For M-type inserts with nose corner angles of 55° (Shape: D), 35° (Shape: V), 25° (Shape: Y)

Inscribed circle	Tolerance on inscribed circle dia. (ød)		Tolerance on corner height (m)	Insert shapes applied
	J,K,L,M,N (class)	U (class)		
6.35	±0.05	±0.08	±0.11	D
9.525				
12.7				
15.875	±0.1	±0.18	±0.18	
19.05				
6.35	±0.05	±0.16	±0.16	V
9.525				Y

Unit: mm

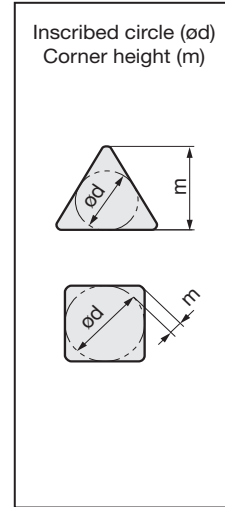

[Example]

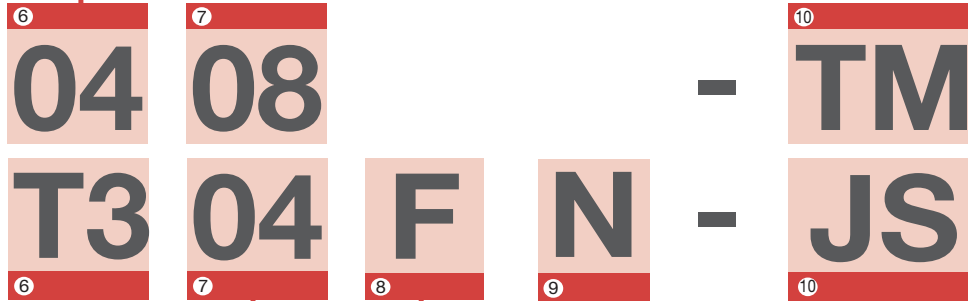

7 Corner radius	
Symbol	Corner radius r_E (mm)
00	0.03
02	0.2
04	0.4
08	0.8
12	1.2
16	1.6
20	2.0
24	2.4
28	2.8
32	3.2

8 Symbols of major cutting edge		
Symbol	Condition of cutting edge	Shape
F	Sharp edge	
E	Honed rounded edge	
W.T	Honed chamfered edge	
S	Combination honed edge	

9 Hand of insert	
Symbol	Hand
R	Right
L	Left
N	Neutral

10 Chipbreakers			
Symbol	Applications	Symbol	Applications
01(TF)	Precision finishing (Basic selection)	CB	Medium cutting
TS	Finishing (Basic selection)	CM	Medium cutting of cast irons
TSF	Finishing (Basic selection)	All-round	Medium cutting
TM	Medium cutting (Basic selection)	A	Finishing (Right and left hand)
THS	Medium to heavy cutting (Basic selection)	B	Finishing (Right and left hand)
TRS	Medium to heavy cutting	C	Finishing (Right and left hand)
TUS	Heavy cutting	D	Finishing (Right and left hand)
DM	Medium cutting	P	Finishing of Aluminium alloys
HRF	Finishing	W	Finishing (Angular type)
HRM	Finishing to medium cutting	PSF	Finishing (Positive type)
HMM	Medium cutting	PSS	Finishing to light cutting (Positive insert)
SF	Finishing of stainless steels	PS	Finishing to medium cutting (Positive type Basic selection)
SS	Finishing of stainless and mild steels	PM	Medium cutting (Positive type)
SM	Medium cutting of stainless steels	AL	Finishing to medium cutting of aluminium alloys
S	Medium cutting of stainless steels	RS	Medium cutting (For round inserts)
SH	Medium to heavy cutting of stainless steels	W□	Finishing (Angular type)
SA	For heat-resisting alloys and stainless steels	H□	Finishing (Parallel)
ZF	Finishing and copying	11	Finishing
ZM	Finishing to medium cutting and copying	61	Small depth of cut and high feed (For round inserts)
NS	Finishing and copying	S1	Finishing (For KNMX type)
NM	Finish to medium cutting and copying	J08,J10	For small lathes
AS	Small depth of cut and high feed	JS	For small lathes
AM	Small depth of cut and high feed	JRP	For small lathes
FW	Finishing (Wiper type)	JPP	For small lathes
SW	Finishing to medium cutting (Wiper type)	JSP	For small lathes
AFW	Small depth of cut and high feed (Wiper type Inserts)		
ASW	Small depth of cut and high feed (Wiper type Inserts)		



Insert

TurnLine - Chipbreaker Guide

BASIC CHIPBREAKERS: NEGATIVE INSERTS

Steel

Chipbreaker System for Turning (Negative Inserts)

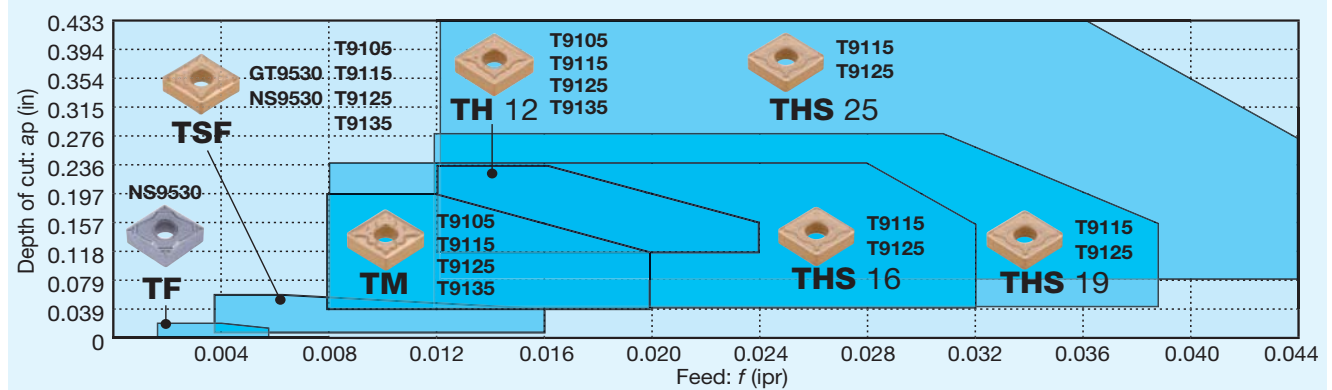

CVD coated grades

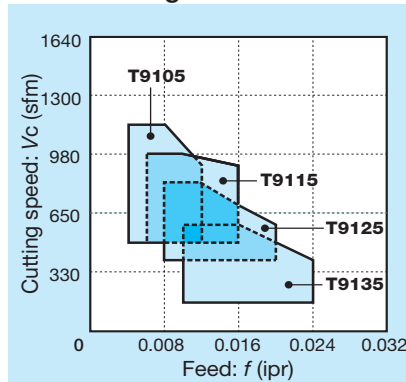

Coated cermets / Cermets

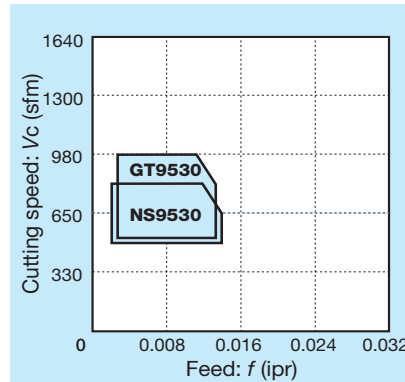

Chipbreaker	Appearance	Features	Chipbreaker	Appearance	Features
TF		The sharp cutting edge and raised projection near corner contribute to excellent chip control at very small depths of cut and low feeds. Economical M-class tolerance and low cost.	TM		General purpose chipbreaker used for medium cutting. Unique chipbreaker geometry with sharp edges and large rake angle assures free cutting action in a wide range of cutting conditions.
TFSF		First choice chipbreaker for finishing steels. The dimple structure decreases the contact area between the insert surface and chips, resulting in significant reduction of heat occurrence.	TH		Double-sided 3-dimensional chipbreaker with a wide land and broad groove used for medium to heavy cutting including interrupted and unfavorable surface conditions. Also performs well in high feed machining.
			THS		Excellent chip control in a broad range of depth of cut. Strong cutting edge being suitable for interrupted and high feed operations.

STANDARD CUTTING CONDITIONS

ISO	Operation	Work condition	Chip-breaker	Grade	Depth of cut ap (in)	Feed f (ipr)	Cutting speed: Vc (sfm)		
							Low carbon steels, Alloy steels	Medium carbon steels, Alloy steels	High carbon steels, Alloy steels
P	Precision finishing	Continuous to light interrupted	TF	NS9530	0.002 - 0.020	0.001 - 0.006	500 - 820	330 - 820	330 - 660
		Continuous to light interrupted	TFSF	GT9530	0.008 - 0.060	0.003 - 0.016	500 - 980	260 - 820	260 - 660
	Finishing	Heavy interrupted	TFSF	T9125	0.008 - 0.060	0.003 - 0.016	400 - 820	260 - 660	260 - 500
		Medium cutting	Continuous to heavy interrupted	TM	T9105	0.040 - 0.200	0.008 - 0.020	590 - 1150	590 - 1150
	TM			T9115	0.040 - 0.200	0.008 - 0.020	500 - 980	500 - 980	400 - 820
	TM			T9125	0.040 - 0.200	0.008 - 0.020	400 - 820	260 - 660	260 - 500
	TM			T9135	0.040 - 0.200	0.008 - 0.020	160 - 590	160 - 500	160 - 400
	Medium to heavy cutting	Continuous to heavy interrupted	TH	T9105	0.120 - 0.240	0.012 - 0.024	590 - 1150	590 - 1150	590 - 980
			TH	T9115	0.120 - 0.240	0.012 - 0.024	500 - 980	500 - 980	400 - 820
			TH	T9125	0.120 - 0.240	0.012 - 0.024	400 - 820	260 - 660	260 - 500
TH			T9135	0.120 - 0.240	0.012 - 0.024	160 - 590	160 - 500	160 - 400	

Low carbon steels, Alloy steels: 1018, 1020, etc. Medium carbon steels, Alloy steels: 1045, 4140, etc. High carbon steels, Alloy steels: 8620, etc.

TurnLine - Selection System









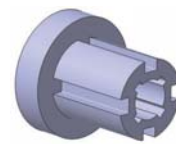
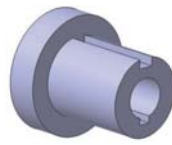
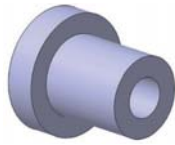

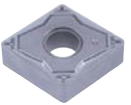
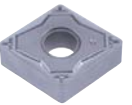
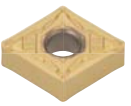
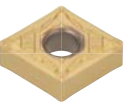
Insert

SELECTION SYSTEM: NEGATIVE INSERTS

P Steel



	Continuous	Light interrupted	Heavy interrupted
Precision finishing [$a_p = \sim 0.020$ in]	<p>Basic</p>  <p>TF NS9530</p> <p>Wear → 01 GT9530</p>	<p>Basic</p>  <p>TF NS9530</p> <p>Fracture → TSF GT9530</p>	
Finishing [$a_p = 0.012 \sim 0.060$ in]	<p>Basic</p>  <p>TSF GT9530</p> <p>Chip control → ZF GT9530</p>	<p>Basic</p>  <p>TSF GT9530</p> <p>Fracture → TSF T9115</p>	<p>Basic</p>  <p>TSF T9125</p> <p>Fracture → TSF T9135</p>
Medium cutting [$a_p = 0.039 \sim 0.157$ in]	<p>Basic</p>  <p>TM T9115</p> <p>Wear → TM T9105</p> <p>Chip control → ZM T9115</p>	<p>Basic</p>  <p>TM T9125</p> <p>Fracture → TM T9135</p> <p>Wear → TM T9115</p>	<p>Basic</p>  <p>TM T9135</p> <p>Fracture → DM T9135</p>
Medium to heavy cutting [$a_p = 0.118 \sim 0.236$ in]	<p>Basic</p>  <p>TH T9115</p> <p>Wear → TH T9105</p> <p>Chip control → TM T9115</p>	<p>Basic</p>  <p>TH T9125</p> <p>Fracture → TH T9135</p> <p>Wear → TH T9115</p>	<p>Basic</p>  <p>TH T9135</p> <p>Fracture → TUS T9135</p>



Insert

TurnLine - Chipbreaker Guide

BASIC CHIPBREAKERS: NEGATIVE INSERTS

M Stainless Steel

Chipbreaker System for Turning

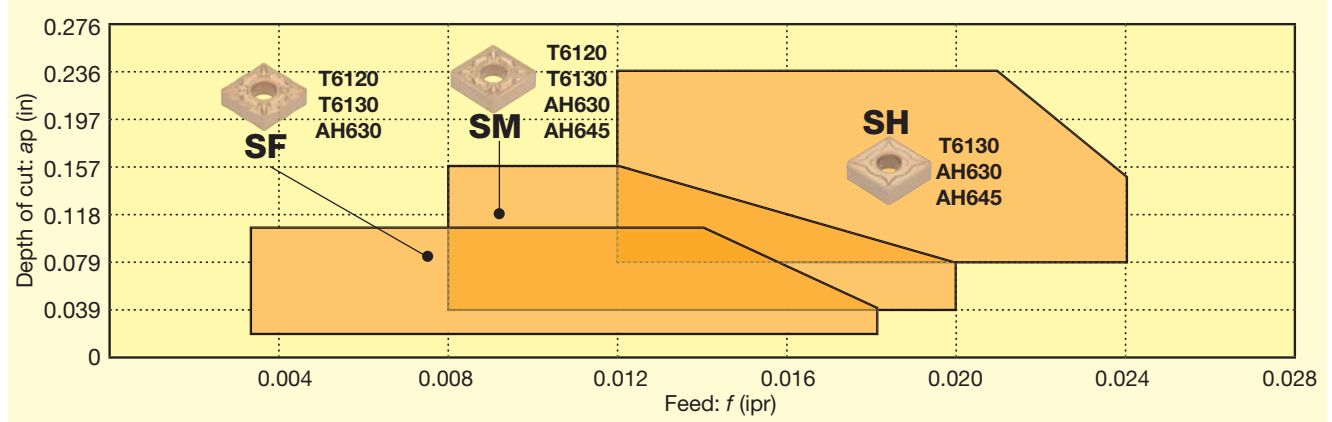

Austenitic stainless steel

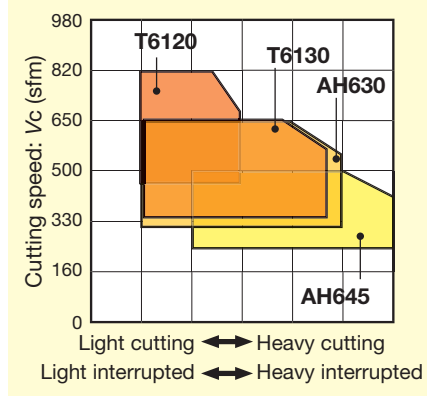

Ferritic / martensite stainless steel

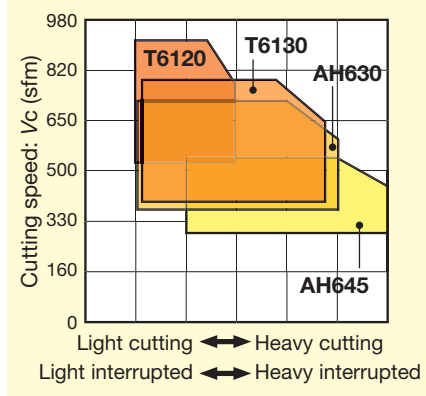

Precipitation hardened stainless steel

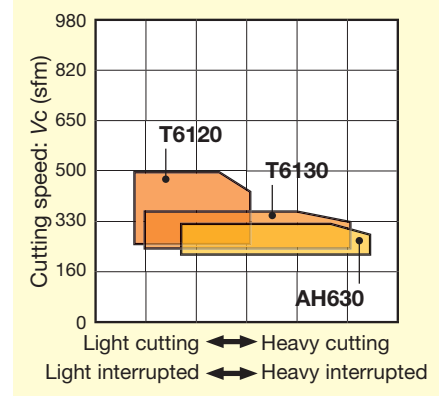

Chipbreaker	Appearance	Features
SF		Excellent chip control when finish cutting. Outstanding chip control when high feed turning at small depth of cut.
SH		Suitable for roughing operations and interrupted machining with tough cutting edges.

Chipbreaker	Appearance	Features
SM		Applicable to a wide range of cutting condition with sharp edge. Recommended chipbreaker for stainless steel turning.

STANDARD CUTTING CONDITIONS

ISO	Operation	Work condition	Chipbreaker	Grade	Depth of cut ap (in)	Feed f (ipr)	Cutting speed Vc (sfm)
M	Finishing	Continuous	SF	T6120	0.020 - 0.098	0.003 - 0.018	460 - 790
		Continuous to light interrupted	SF	T6130	0.020 - 0.098	0.003 - 0.018	330 - 660
		Heavy interrupted	SF	AH630	0.020 - 0.098	0.003 - 0.018	300 - 620
	Medium cutting	Continuous	SM	T6120	0.040 - 0.160	0.008 - 0.020	460 - 790
		Continuous to light interrupted	SM	T6130	0.040 - 0.160	0.008 - 0.020	330 - 660
		Light interrupted	SM	AH630	0.040 - 0.160	0.008 - 0.020	300 - 620
		Heavy interrupted	SM	AH645	0.040 - 0.160	0.008 - 0.020	230 - 500
	Medium to heavy cutting	Continuous to light interrupted	SH	T6130	0.080 - 0.240	0.012 - 0.024	330 - 660
		Light interrupted	SH	AH630	0.080 - 0.240	0.012 - 0.024	300 - 620
Heavy interrupted		SH	AH645	0.080 - 0.240	0.012 - 0.024	230 - 500	

Stainless steels: 304SS, 316SS, etc.

TurnLine - Selection System



Insert

SELECTION SYSTEM: NEGATIVE INSERTS

M Stainless Steel

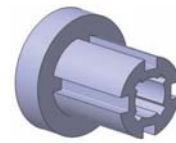
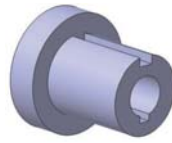
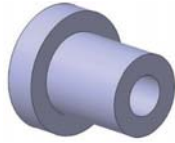

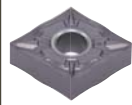
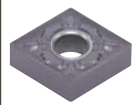
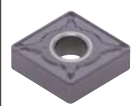
	Continuous	Light interrupted	Heavy interrupted
Finishing [$a_p = 0.020 \sim 0.060$ in]	Basic  SF T6120 Fracture → SF T6130	Basic  SF T6130 Fracture → SF AH630 Wear → SF T6120	Basic  SF AH630 Fracture → SF AH645 Wear → SF T6130
Medium cutting [$a_p = 0.039 \sim 0.157$ in]	Basic  SM T6130 Wear → SM T6120 Chip control → SF T6130	Basic  SM AH630 Fracture → SM AH645 Wear → SM T6130	Basic  SM AH645 Fracture → SH AH645
Medium to heavy cutting [$a_p = 0.079 \sim 0.236$ in]	Basic  SH T6130 Fracture → SH AH630 Wear → SH T6120 Chip control → SM T6130	Basic  SH AH630 Fracture → SH AH645 Wear → SH T6130	Basic  SH AH645 Wear → SH AH630



Insert

TurnLine - Chipbreaker Guide

BASIC CHIPBREAKERS: NEGATIVE INSERTS

K Cast Iron

Chipbreaker System for Turning (Negative Inserts)

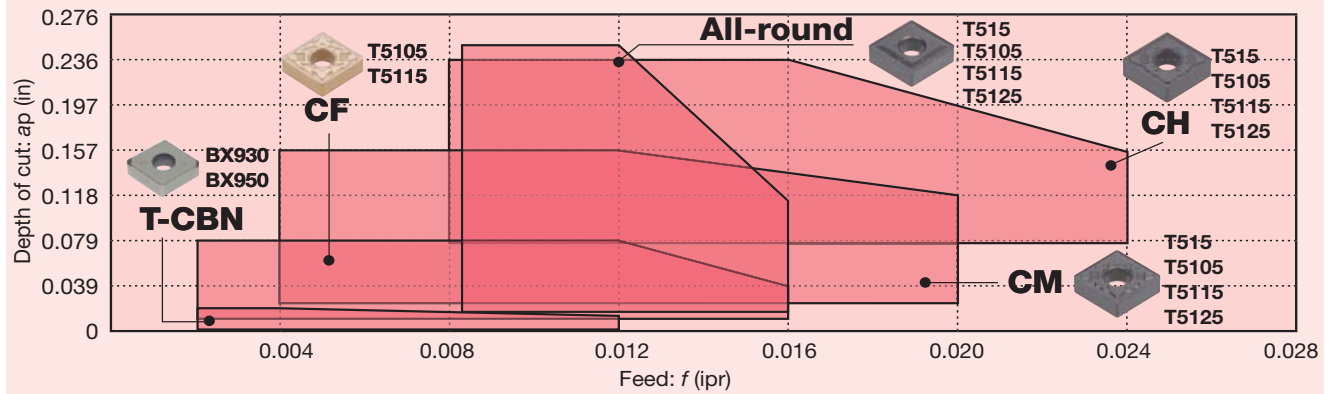

Grey cast irons

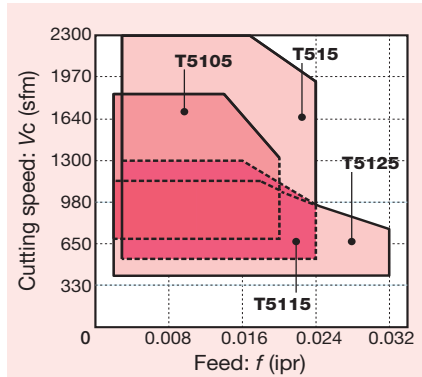

Ductile cast irons

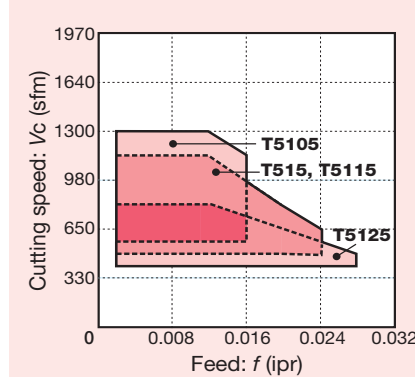

High speed cutting: for grey cast irons

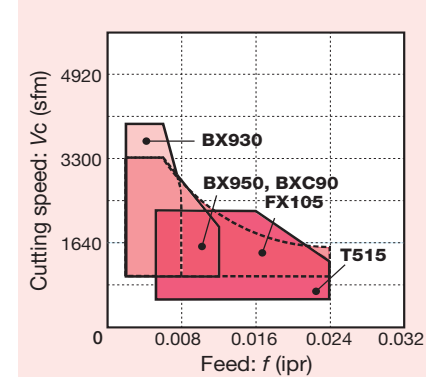

Chip-breaker	Appearance	Features
No chip-breaker (T-CBN)		T-CBN inserts. Performs well in high speed finishing of cast iron.
CF		Low cutting force chipbreaker for cast iron. Combined with an arc-shaped concave and a high rake (substantially 20° rake angle), allows drastically reducing cutting forces and suppressing the deformation of thin walled components and burr occurrence.
All-round		Highly reliable chipbreaker for medium cutting under a wide range of conditions from continuous to interrupted cutting.

Chip-breaker	Appearance	Features
CM		First choice chipbreaker for cast iron. An all around chipbreaker, which is applicable for a wide range of cutting conditions from continuous to interrupted machining with the positive land and wide chip pocket
CH		Chipbreaker with reinforced cutting-edge for cast iron. Utilizing the land support and negative land design, features stable insert seating and high cutting edge strength even in heavy cutting.

STANDARD CUTTING CONDITIONS

ISO	Operation	Work condition	Chip-breaker	Grade	Depth of cut ap (in)	Feed f (ipr)	Cutting speed: Vc (sfm)	
							Grey cast irons	Ductile cast irons
K	High speed cutting	Continuous	Without	BX930	0.002 - 0.020	0.002 - 0.008	984 - 3937	328 - 1640
		Light interrupted	Without	BX950	0.002 - 0.020	0.002 - 0.012	984 - 3281	328 - 984
		Continuous	Without	BXC90	0.003 - 0.118	0.002 - 0.016	984 - 3281	328 - 984
Finishing	Continuous	CF	T515	0.039 - 0.197	0.004 - 0.020	150 - 2297	459 - 1214	
	Light interrupted	CF	T515	0.039 - 0.197	0.004 - 0.020	150 - 2297	459 - 1214	
	Continuous	CM	T515	0.039 - 0.197	0.004 - 0.020	150 - 2297	459 - 1214	
Medium cutting	Continuous	AR	T515	0.039 - 0.197	0.004 - 0.020	150 - 2297	459 - 1214	
	Light interrupted	CM	T515	0.039 - 0.197	0.004 - 0.020	150 - 2297	459 - 1214	
	Continuous	CH	T515	0.118 - 0.236	0.008 - 0.024	150 - 2297	459 - 1214	
Heavy cutting	Continuous	CH	T515	0.039 - 0.197	0.004 - 0.020	150 - 2297	459 - 1214	
	Light interrupted	CH	T515	0.039 - 0.197	0.004 - 0.020	150 - 2297	459 - 1214	
	Continuous	CH	T515	0.118 - 0.236	0.008 - 0.024	150 - 2297	459 - 1214	

Grey cast irons: Class 25, etc. Ductile cast irons: 65-45-12, etc.

TurnLine - Selection System



Insert

SELECTION SYSTEM: NEGATIVE INSERTS

K Cast Iron

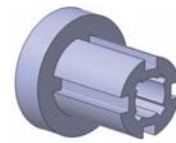
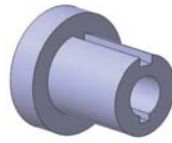
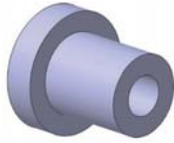

	Continuous	Light interrupted	Heavy interrupted
Finishing [$a_p = 0.020 \sim 0.079$ in.]	<p>Basic → Wear → All-round T5105</p> <p>All-round T515 → Burr occurrence → CF T5105</p>	<p>Basic → Wear → All-round T5105</p> <p>All-round T515 → Fracture → CH T515</p> <p>All-round T515 → Burr occurrence → CF T5115</p>	<p>Basic → Wear → CH T5105</p> <p>Basic → Fracture → CH T5125</p> <p>CH T515 → Burr occurrence → All-round T515</p>
Medium cutting [$a_p = 0.039 \sim 0.197$ in.]	<p>Basic → Wear → All-round T5105</p> <p>All-round T515 → Burr occurrence → CF T5105</p>	<p>Basic → Wear → All-round T5105</p> <p>All-round T515 → Fracture → CH T515</p> <p>All-round T515 → Burr occurrence → CF T5115</p>	<p>Basic → Wear → CH T5105</p> <p>Basic → Fracture → CH T5125</p> <p>CH T515 → Burr occurrence → All-round T515</p>
Medium to heavy cutting [$a_p = 0.118 \sim 0.236$ in.]	<p>Basic → Wear → All-round T5105</p> <p>All-round T515 → Burr occurrence → CF T5105</p>	<p>Basic → Wear → All-round T5105</p> <p>All-round T515 → Fracture → CH T515</p> <p>All-round T515 → Burr occurrence → CF T5115</p>	<p>Basic → Wear → CH T5105</p> <p>Basic → Fracture → CH T5125</p> <p>CH T515 → Burr occurrence → All-round T515</p>



Insert

TurnLine - Chipbreaker Guide

BASIC CHIPBREAKERS: NEGATIVE INSERTS

N Non-ferrous Metal

Chipbreaker System for Turning (Negative Inserts)

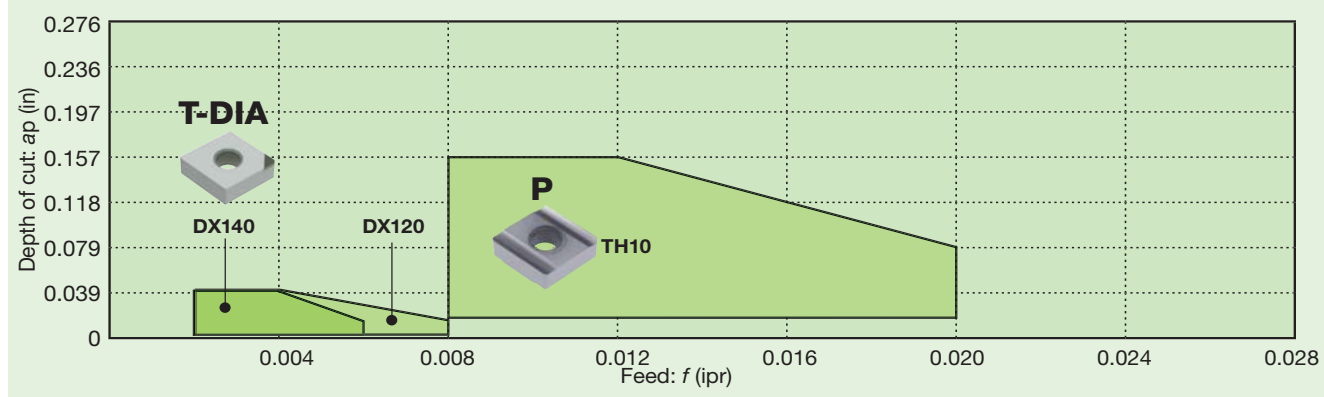

Aluminum alloys (Si < 12%)

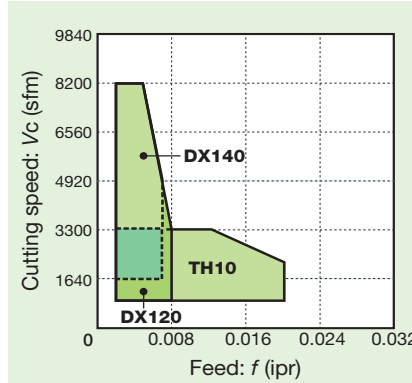

Aluminum alloys (Si ≥ 12%)

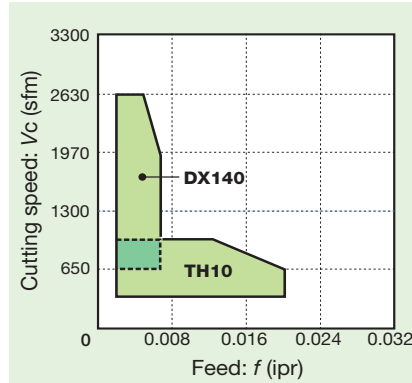

Copper alloys

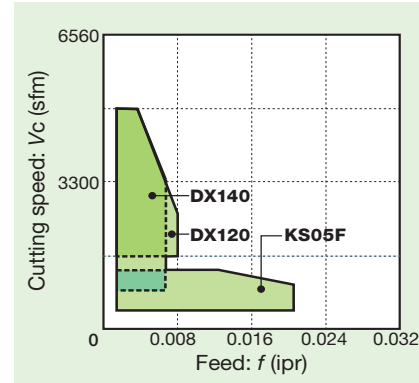

Chip-breaker	Appearance	Features
No chip-breaker (T-DIA)		Performs well in high speed finishing of non-ferrous materials.
P		Excels in sharpness of cutting edges and effectively used for machining non-ferrous metals such as aluminum alloys and copper alloys.

Chip-breaker	Appearance	Features
With chip-breaker (T-DIA)		The wide chipbreaker width contributes to excellent chip control.

STANDARD CUTTING CONDITIONS

ISO	Operation	Work condition	Chip-breaker	Grade	Depth of cut ap (in)	Feed f (ipr)	Cutting speed: Vc (sfm)		
							Aluminum alloys (Si < 12%)	Aluminum alloys (Si > 12%)	Copper alloys
N	Precision finishing	Continuous	With	DX120	0.002 - 0.040	0.002 - 0.006	1640 - 8200	1310 - 2630	1640 - 4920
		Light interrupted	Without	DX140	0.002 - 0.040	0.002 - 0.008	980 - 8200	-	1640 - 4920
	Finishing	Continuous	Without	DX140	0.002 - 0.040	0.002 - 0.006	1640 - 8200	1310 - 2630	1640 - 4920
		Light interrupted	Without	DX140	0.002 - 0.040	0.002 - 0.006	980 - 5900	1310 - 1970	1310 - 3940
		Heavy interrupted	P	TH10	0.020 - 0.160	0.008 - 0.020	330 - 1640	330 - 660	330 - 660
	Medium cutting	Continuous	P	TH10	0.020 - 0.160	0.008 - 0.020	330 - 3280	330 - 980	330 - 980
Light interrupted		P	TH10	0.020 - 0.160	0.008 - 0.020	330 - 2630	330 - 660	330 - 660	
Heavy interrupted		P	TH10	0.020 - 0.160	0.008 - 0.020	330 - 1640	330 - 660	330 - 660	

TurnLine - Selection System



Insert

SELECTION SYSTEM: NEGATIVE INSERTS

N Non-ferrous Metal

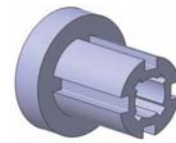
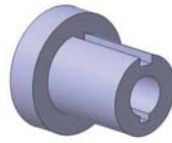
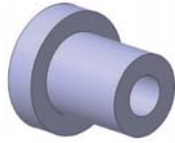

	Continuous	Light interrupted	Heavy interrupted
Precision finishing [$a_p = \sim 0.020$ in.]	<p>Basic</p> <p>With chipbreaker DX120</p> <p>T-DIA DX140</p>	<p>Basic</p> <p>Surface</p> <p>With chipbreaker T-DIA DX120</p> <p>T-DIA DX140</p> <p>T-DIA DX160</p>	
Finishing [$a_p = 0.020 \sim 0.079$ in.]	<p>Basic</p> <p>Surface</p> <p>With chipbreaker T-DIA DX120</p> <p>T-DIA DX140</p> <p>T-DIA DX160</p>	<p>Basic</p> <p>Fracture</p> <p>P TH10</p> <p>T-DIA DX140</p> <p>T-DIA DX160</p>	<p>Basic</p> <p>P TH10</p>
Medium cutting [$a_p = 0.039 \sim 0.157$ in.]	<p>Basic</p> <p>P TH10</p> <p>T-DIA DX140</p>	<p>Basic</p> <p>P TH10</p> <p>T-DIA DX140</p>	<p>Basic</p> <p>P TH10</p>



TurnLine - Chipbreaker Guide

BASIC CHIPBREAKERS: NEGATIVE INSERTS

S Superalloys and titanium

Chipbreaker System for Turning (Negative Inserts)

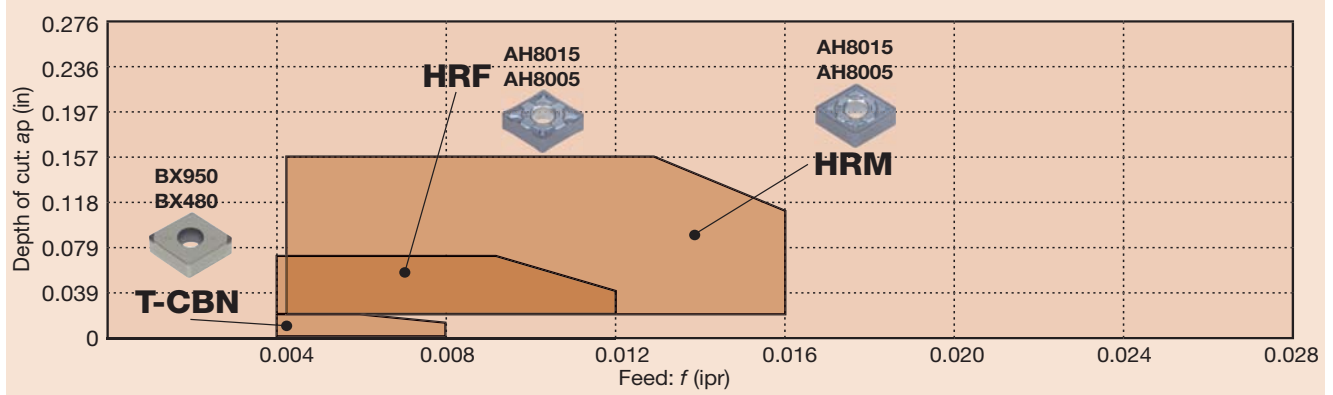

Titanium alloys

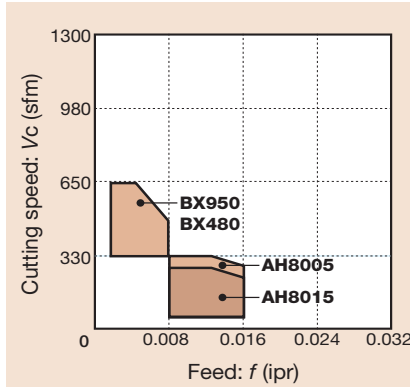

Ni-base alloys

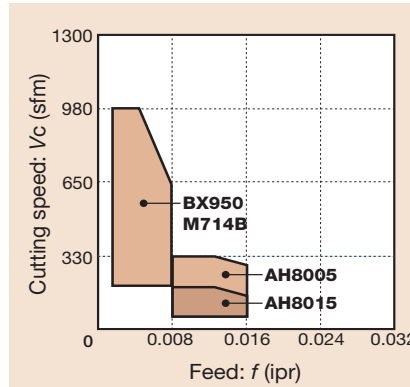

Chipbreaker	Appearance	Features
HRF		Suitable for finishing operation of superalloys. Special protrusion provides excellent chip control in lower depth of cut.
HRM		The 1st recommended chipbreaker for superalloy turning. Optimized geometry provides stable chip control in various depth of cut.

Chipbreaker	Appearance	Features
No chip-breaker (T-CBN)		T-CBN inserts. Performs well in finishing of heat-resistant or titanium alloys.

STANDARD CUTTING CONDITIONS

ISO	Operation	Work condition	Chip-breaker	Grade	Depth of cut ap (in)	Feed f (ipr)	Cutting speed: Vc (sfm)	
							Titanium alloys	Ni-base alloys
	Precision finishing	Continuous	Without	BX950	0.004 - 0.020	0.002 - 0.008	330 - 660	230 - 980
			Without	M714B	0.004 - 0.020	0.002 - 0.008	-	230 - 1310
		Light interrupted	Without	BX480	0.004 - 0.020	0.002 - 0.008	330 - 660	-
S	Finishing	Continuous	HRF	AH8005	0.020 - 0.060	0.002 - 0.010	66 - 330	66 - 330
		Light interrupted	HRF	AH8015	0.020 - 0.060	0.002 - 0.010	66 - 260	66 - 160
		Heavy interrupted	HRF	AH8015	0.020 - 0.060	0.002 - 0.010	33 - 200	33 - 130
	Finishing to medium cutting	Continuous	HRM	AH8005	0.020 - 0.160	0.004 - 0.016	66 - 330	66 - 330
		Light interrupted	HRM	AH8015	0.020 - 0.160	0.004 - 0.016	66 - 260	66 - 160
		Heavy interrupted	HRM	AH8015	0.020 - 0.160	0.004 - 0.016	33 - 200	33 - 130

Ni-base alloys: INCONEL718, etc.
Titanium alloys: Ti-6Al-4V, etc

TurnLine - Selection System







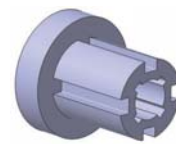
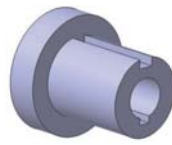
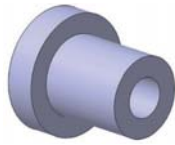

Insert

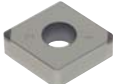
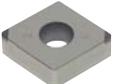
SELECTION SYSTEM: NEGATIVE INSERTS

S Superalloys and titanium



	Continuous	Light interrupted	Heavy interrupted
Precision finishing [$a_p = \sim 0.020$ in]	<p>Basic</p>  <p>T-CBN BX950</p>	<p>Basic</p>  <p>T-CBN BX950</p> <p>Fracture → No chipbreaker TH10</p>	
Finishing [$a_p = 0.020 \sim 0.060$ in]	<p>Basic</p>  <p>HRF AH8015</p> <p>Wear → HRF AH8005</p>	<p>Basic</p>  <p>HRF AH8015</p> <p>Fracture → HRM AH8015</p> <p>Wear → HRF AH8005</p>	<p>Basic</p>  <p>HRF AH8015</p> <p>Fracture → HRM AH8015</p> <p>Wear → HRF AH8005</p>
Medium cutting [$a_p = 0.020 \sim 0.157$ in]	<p>Basic</p>  <p>HRM AH8015</p> <p>Wear → HRM AH8005</p> <p>Chip control → HRF AH8015</p>	<p>Basic</p>  <p>HRM AH8015</p> <p>Fracture → SM AH630</p> <p>Wear → HRM AH8005</p>	<p>Basic</p>  <p>HRM AH8015</p> <p>Fracture → SM AH630</p> <p>Wear → HRF AH8005</p>



TurnLine - Chipbreaker Guide

BASIC CHIPBREAKERS: NEGATIVE INSERTS

H Hard Materials

Chipbreaker System for Turning (Negative Inserts)

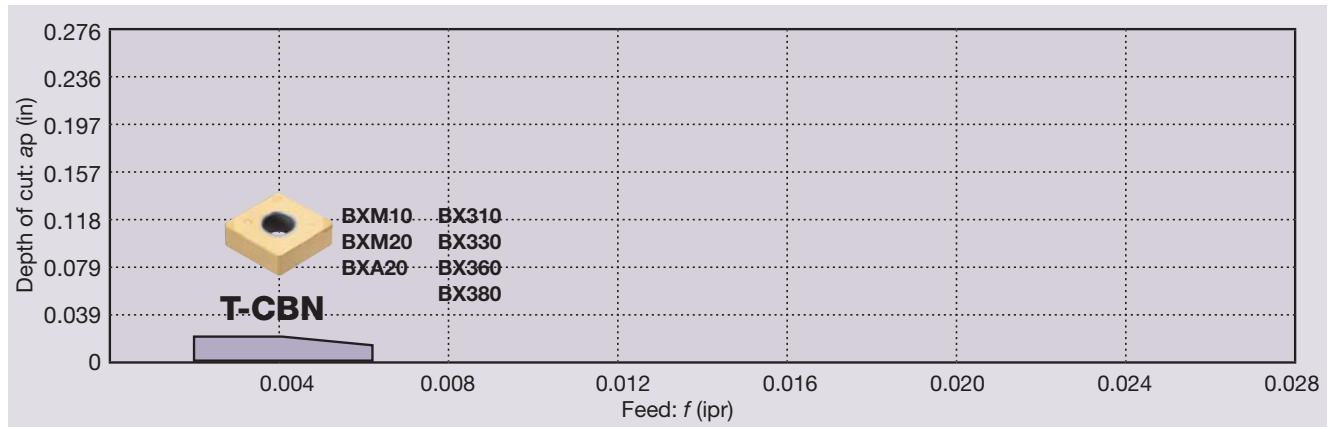

Coated T-CBN

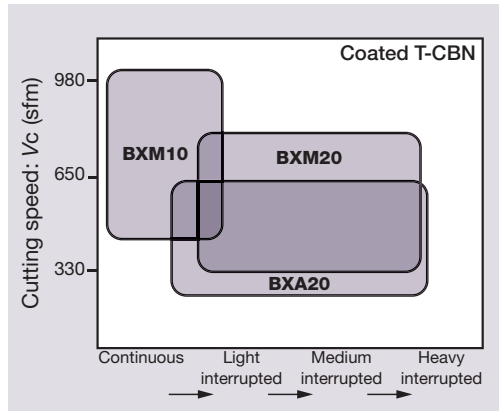

T-CBN

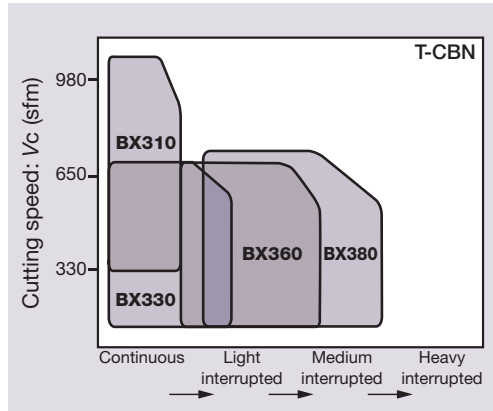

Chipbreaker	Appearance	Features
No chip-breaker (T-CBN)		Performs well in finishing of hardened steel.

Chipbreaker	Appearance	Features
HF		When used in removing a carburized layer, excels in chip control at small depth of cut.
HM		When used in removing a carburized layer, excels in chip control at large depth of cut.

STANDARD CUTTING CONDITIONS

ISO	Operation	Work condition	Chipbreaker	Grade	Depth of cut ap (in)	Feed f (ipr)	Cutting speed Vc (sfm)
H	Precision finishing	Continuous to light interrupted	Without	BXM10 BXA20	0.002 - 0.008	0.001 - 0.007	500 - 1150
	Finishing	Continuous to heavy interrupted	Without	BXM10 BXM20 BXA20	0.002 - 0.020	0.002 - 0.010	230 - 720
	Removing of carburized layer	Continuous	HF	BXM20	0.008 - 0.030	0.002 - 0.008	230 - 660
		Continuous	HM	BXM20 BXA20	0.020 - 0.040	0.002 - 0.008	230 - 660

Hardened steels, Pre-hardened steels: D2, H13, etc.

TurnLine - Selection System





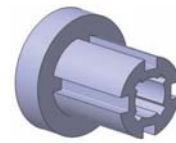
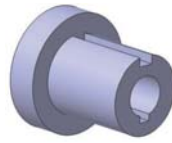
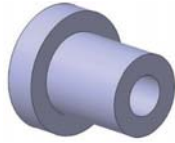

Insert

SELECTION SYSTEM: NEGATIVE INSERTS

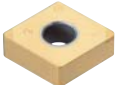
H Hard Materials

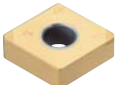

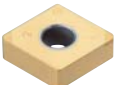
	Continuous	Light interrupted	Heavy interrupted
Precision finishing [$a_p \sim 0.008$ in]	<p>Basic</p>  <p>T-CBN BXM10</p>	<p>Basic</p>  <p>T-CBN BXA20</p> <p>Fracture → -H BXM20</p> <p>For high speed Wear → T-CBN BXM10</p>	
Finishing [$a_p \sim 0.020$ in]	<p>Basic</p>  <p>T-CBN BXM10</p>	<p>Basic</p>  <p>T-CBN BXA20</p> <p>Fracture → -H BXM20</p> <p>For high speed Wear → T-CBN BXM10</p>	<p>Basic</p>  <p>T-CBN BXM20</p> <p>Fracture → -H BXM20</p>



Insert

TurnLine - Chipbreaker Guide

BASIC CHIPBREAKERS: POSITIVE INSERTS

P Steel

Chipbreaker System for Turning (Positive Inserts)

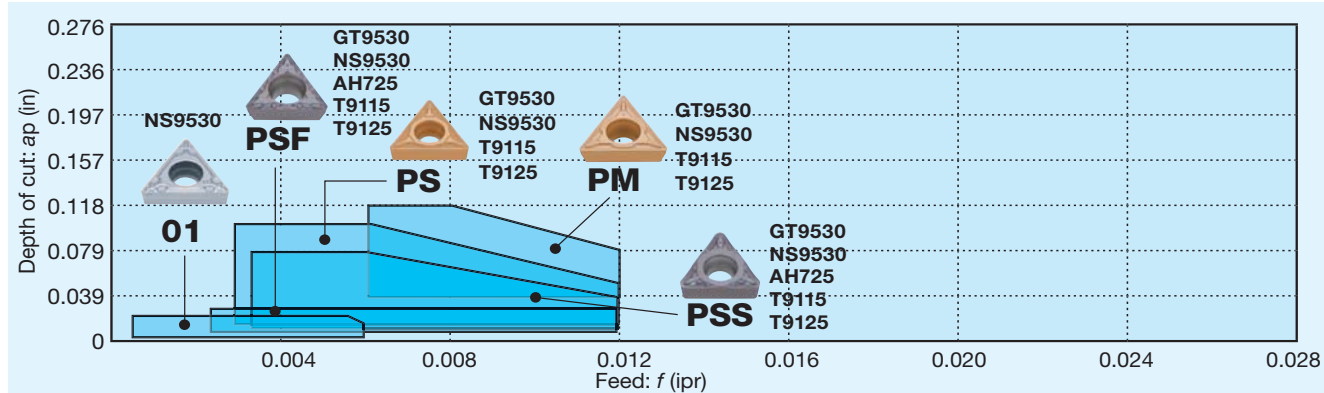

CVD / PVD coated grades

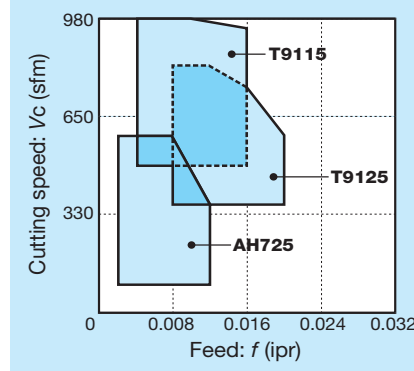

Coated cermets / Cermets

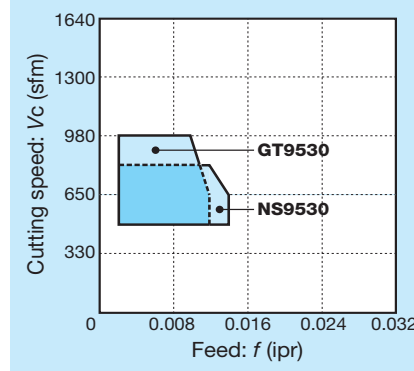

Chipbreaker	Appearance	Features
01		The sharp cutting edge and raised projection near corner contribute to excellent chip control at very small depth of cut and low feed.
PSF		Developed chipbreaker for finishing at low cutting depths. Optimal chip control due to pre-positioned chipbreaker element.
PSS		3-dimensional chipbreaker designed to have excellent chip control capability and low cutting force in finishing to medium cutting. Low cost, M-class positive insert used for high efficiency boring in a wide range of applications.

Chipbreaker	Appearance	Features
PS		3-dimensional chipbreaker designed to have excellent chip control capability and low cutting force in finishing to medium cutting. Low cost, M-class positive insert used for high efficiency boring in a wide range of applications.
PM		Developed chipbreaker for medium cutting. Excellent chip control due to wide, positive chip flow zone.

STANDARD CUTTING CONDITIONS

ISO	Operation	Work condition	Chip-breaker	Grade	Depth of cut ap (in)	Feed f (ipr)	Cutting speed: Vc (sfm)		
							Low carbon steels, Alloy steels	Medium carbon steels, Alloy steels	High carbon steels, Alloy steels
P	Precision finishing	Continuous	01	NS9530	0.002 - 0.020	0.001 - 0.006	500 - 820	260 - 720	260 - 590
		Light interrupted	01	NS9530	0.002 - 0.020	0.001 - 0.006	500 - 820	260 - 720	260 - 590
	Finishing	Continuous	PSS	NS9530	0.004 - 0.020	0.002 - 0.012	500 - 820	260 - 720	260 - 590
		Light interrupted	PSS	NS9530	0.004 - 0.020	0.002 - 0.012	500 - 820	260 - 720	260 - 590
		Heavy interrupted	PSS	NS9530	0.004 - 0.020	0.002 - 0.012	500 - 820	260 - 720	260 - 590
	Finishing to light cutting	Continuous	PS	NS9530	0.012 - 0.079	0.003 - 0.012	500 - 820	260 - 720	260 - 590
		Light interrupted	PS	NS9530	0.012 - 0.079	0.003 - 0.012	500 - 820	260 - 720	260 - 590
		Heavy interrupted	PS	NS9530	0.012 - 0.079	0.003 - 0.012	500 - 820	260 - 720	260 - 590
	Finishing to Medium cutting	Continuous to Heavy interrupted	PS	T9115	0.020 - 0.098	0.003 - 0.012	500 - 980	330 - 660	260 - 590
		Heavy interrupted	PS	T9125	0.020 - 0.098	0.003 - 0.012	400 - 820	260 - 590	260 - 400
	Medium cutting	Continuous to Heavy interrupted	PM	T9115	0.040 - 0.120	0.006 - 0.012	500 - 980	330 - 660	260 - 590
			PM	T9125	0.040 - 0.120	0.006 - 0.012	400 - 820	260 - 590	260 - 400

Low carbon steels, Alloy steels: 1018, 1020, etc. Medium carbon steels, Alloy steels: 1045, 4140, etc. Hi carbon steels, Alloy steels: 8620, etc.

TurnLine - Selection System







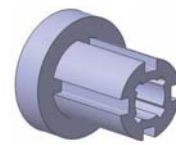
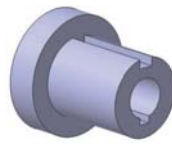
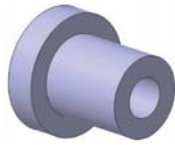

Insert

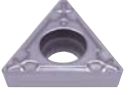
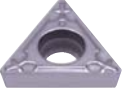
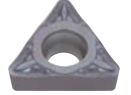
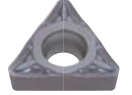
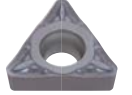
SELECTION SYSTEM: POSITIVE INSERTS

P Steel



	Continuous	Light interrupted	Heavy interrupted
Precision finishing [$a_p = \sim 0.020$ in]	<p>Basic</p>  <p>01 NS9530</p>	<p>Basic</p>  <p>01 NS9530</p> <p>Fracture → PSF NS9530</p>	
Finishing [$a_p = 0.004 \sim 0.020$ in]	<p>Basic</p>  <p>PSS NS9530</p> <p>Wear → PSS GT9530</p> <p>Fracture → PS NS9530</p> <p>Chip control → PSF NS9530</p>	<p>Basic</p>  <p>PSS NS9530</p> <p>Wear → PSS GT9530</p> <p>Fracture → PS NS9530</p> <p>Chip control → PSF NS9530</p>	<p>Basic</p>  <p>PSS NS9530</p> <p>Wear → PSS GT9530</p> <p>Fracture → PS NS9530</p> <p>Chip control → PSF NS9530</p>
Finishing to Medium cutting [$a_p = 0.020 \sim 0.098$ in]	<p>Basic</p>  <p>PS T9115</p> <p>Fracture → PS T9125</p> <p>Wear → PS NS9530</p>	<p>Basic</p>  <p>PS T9115</p> <p>Fracture → PS T9125</p> <p>Wear → PS NS9530</p>	<p>Basic</p>  <p>PS T9115</p> <p>Fracture → PM T9125</p>
Medium cutting [$a_p = 0.039 \sim 0.118$ in]	<p>Basic</p>  <p>PM T9115</p> <p>Wear → PM NS9530</p>	<p>Basic</p>  <p>PM T9115</p> <p>Fracture → PM T9125</p>	<p>Basic</p>  <p>PM T9115</p>



Insert

TurnLine - Chipbreaker Guide

BASIC CHIPBREAKERS: POSITIVE INSERTS

M Stainless Steel

Chipbreaker System for Turning (Positive Inserts)

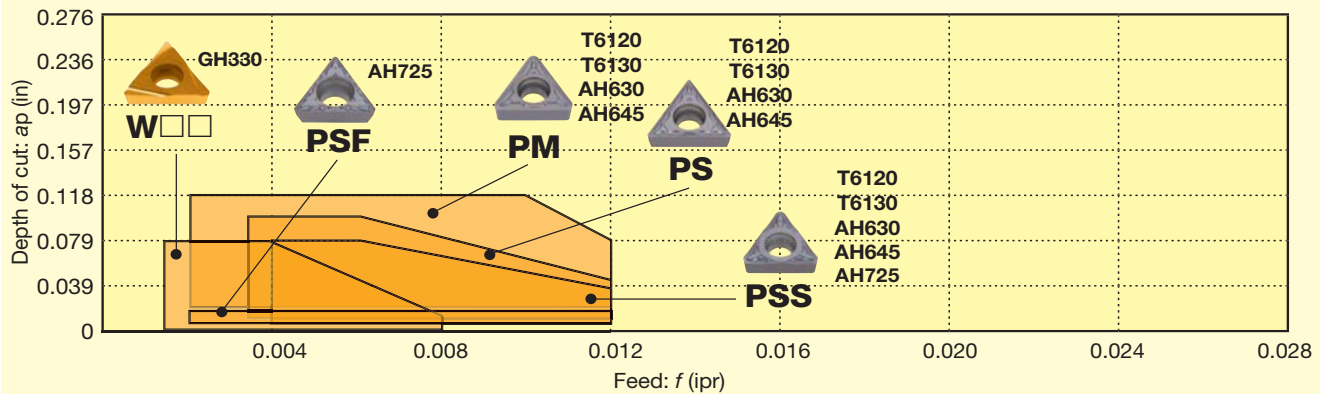

CVD coated grades

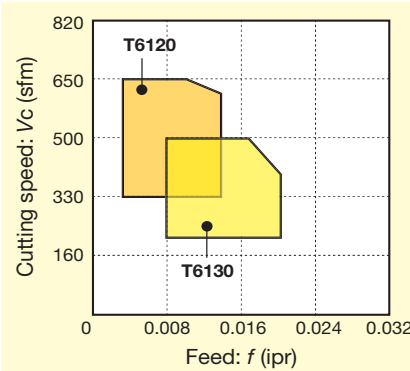

PVD coated grades

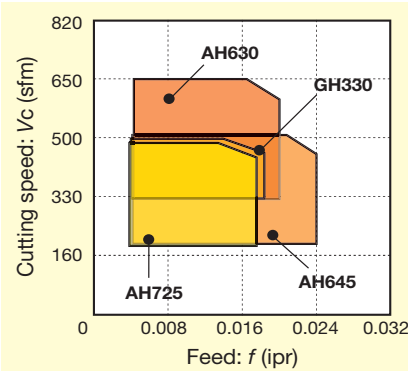

Chipbreaker	Appearance	Features
W□□		Designed to control the direction of chip flow and used for precision finish boring. Provides excellent chip evacuation which is important to attain a highly accurate bore.
PSF		Developed chipbreaker for finishing at low cutting depths. Optimal chip control due to pre-positioned chipbreaker element.

Chipbreaker	Appearance	Features
PSS		3-dimensional chipbreaker designed to have excellent chip control capability and low cutting force in finishing to medium cutting. Low cost, M-class positive insert used for high efficiency boring in a wide range of applications.
PS		3-dimensional chipbreaker designed to have excellent chip control capability and low cutting force in finishing to medium cutting. Low cost, M-class positive insert used for high efficiency boring in a wide range of applications.
PM		Developed chipbreaker for medium cutting. Excellent chip control due to wide, positive chip flow zone.

STANDARD CUTTING CONDITIONS

ISO	Operation	Work condition	Chipbreaker	Grade	Depth of cut a_p (in)	Feed f (ipr)	Cutting speed V_c (sfm)
M	Precision finishing	Continuous	W□□	GH330	0.002 - 0.079	0.001 - 0.008	330 - 500
		Continuous	PSF	AH725	0.004 - 0.020	0.002 - 0.012	160 - 500
	Finishing	Light interrupted	PSF	AH725	0.004 - 0.020	0.002 - 0.012	160 - 500
		Heavy interrupted	PSF	AH725	0.004 - 0.020	0.002 - 0.012	160 - 400
	Finishing to light cutting	Continuous	PSS	AH630	0.012 - 0.079	0.003 - 0.012	300 - 620
		Light interrupted	PSS	AH630	0.012 - 0.079	0.003 - 0.012	300 - 620
		Heavy interrupted	PSS	AH630	0.012 - 0.079	0.003 - 0.012	300 - 620
	Finishing to medium cutting	Continuous	PS	T6130	0.020 - 0.098	0.003 - 0.012	330 - 660
		Light interrupted	PS	AH630	0.020 - 0.098	0.003 - 0.012	300 - 620
		Heavy interrupted	PS	AH630	0.020 - 0.098	0.003 - 0.012	300 - 620
	Medium cutting	Continuous	PM	T6130	0.040 - 0.120*	0.006 - 0.012	330 - 660
		Light interrupted	PM	AH630	0.040 - 0.120*	0.006 - 0.012	300 - 620
Heavy interrupted		PM	AH630	0.040 - 0.120*	0.006 - 0.012	300 - 620	

* For CCMT0602 and DCMT0702 type inserts, $a_p = 0.020 - 0.098$
Stainless steels: 304SS, 316SS, etc.

TurnLine - Selection System



Insert

SELECTION SYSTEM: POSITIVE INSERTS

M Stainless Steel

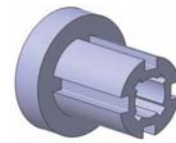
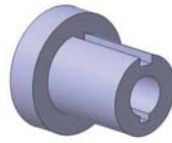
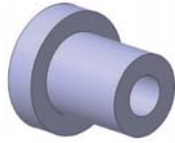

	Continuous	Light interrupted	Heavy interrupted
Precision finishing [$a_p \sim 0.020$ in]	<p>Basic</p>  <p>W□□ GH330</p>	<p>Basic</p>  <p>W□□ GH330</p>	
Finishing [$a_p = 0.012 \sim 0.060$ in]	<p>Basic</p>  <p>PSF AH725</p> <p>Wear → PSS T6130</p>	<p>Basic</p>  <p>PSF AH725</p> <p>Fracture → PSS AH630</p> <p>Wear → PSS T6130</p>	<p>Basic</p>  <p>PSF AH725</p> <p>Fracture → PSS AH630</p>
Finishing to Medium cutting [$a_p = 0.020 \sim 0.098$ in]	<p>Basic</p>  <p>PSS AH630</p> <p>Wear → PS T6130</p>	<p>Basic</p>  <p>PS AH630</p> <p>Fracture → PM AH645</p> <p>Wear → PS T6130</p>	<p>Basic</p>  <p>PS AH630</p> <p>Fracture → PM AH645</p> <p>Wear → PS T6130</p>
Medium cutting [$a_p = 0.039 \sim 0.118$ in]	<p>Basic</p>  <p>PM AH6130</p>	<p>Basic</p>  <p>PM AH630</p> <p>Fracture → PM AH645</p> <p>Wear → PM T6130</p>	<p>Basic</p>  <p>PM AH630</p> <p>Fracture → PM AH645</p>



TurnLine - Chipbreaker Guide

BASIC CHIPBREAKERS: POSITIVE INSERTS

K Cast Iron

Chipbreaker System for Turning (Positive Inserts)

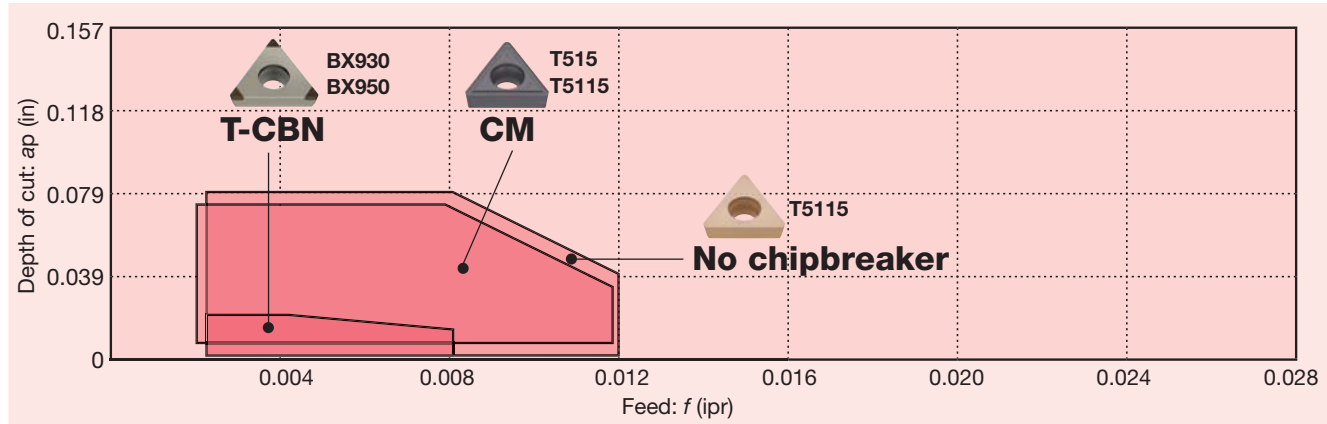

Grey cast irons

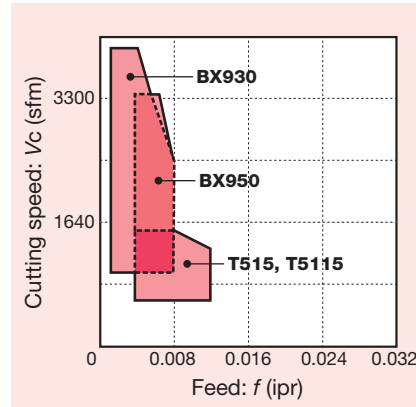

Ductile cast irons

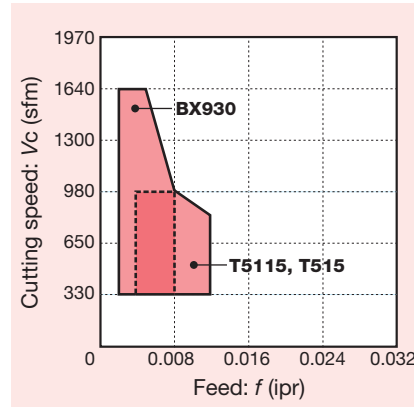

Chipbreaker	Appearance	Features
No chip-breaker (T-CBN)		Performs well in high speed finishing of cast iron.
No chip-breaker		Can cover a wide range of applications from finishing to roughing of cast irons. Excels in cutting edge strength.

Chipbreaker	Appearance	Features
CM		All-around chipbreaker for general purpose cutting, provides low cutting forces and excellent performance in finishing to medium cutting.

STANDARD CUTTING CONDITIONS

ISO	Operation	Work condition	Chip-breaker	Grade	Depth of cut a_p (in)	Feed f (ipr)	Cutting speed: V_c (sfm)	
							Grey cast irons	Ductile cast irons
K	Precision finishing	Continuous	Without	BX930	0.002 - 0.020	0.002 - 0.008	980 - 3940	330 - 1640
		Light interrupted	Without	BX950	0.002 - 0.020	0.002 - 0.008	980 - 2630	330 - 980
			Without	BX470	0.002 - 0.020	0.002 - 0.008	980 - 2630	330 - 980
Finishing	Continuous	CM	T515	0.002 - 0.079	0.002 - 0.012	500 - 2300	500 - 980	
	Heavy interrupted	CM	T515	0.002 - 0.079	0.002 - 0.012	330 - 660	330 - 660	
		CM	T515	0.002 - 0.079	0.002 - 0.012	330 - 980	330 - 820	
Medium cutting	Light interrupted	CM	T515	0.002 - 0.079	0.002 - 0.012	330 - 980	330 - 820	

Grey cast irons: Class 25, etc.
Ductile cast irons: 65-45-12, etc.

TurnLine - Selection System



Insert

SELECTION SYSTEM: POSITIVE INSERTS

K Cast Iron

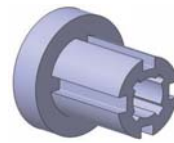
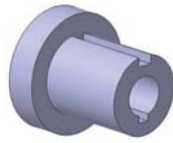
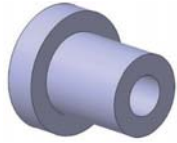

Continuous

Light interrupted

Heavy interrupted

Finishing to Medium cutting
[$a_p = 0.020 \sim 0.118$ in]

Basic



**CM
T515**

Wear

**T-CBN
BX930**

Basic

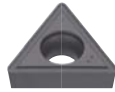

**CM
T515**

Basic

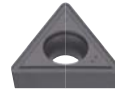

**CM
T515**



Insert

TurnLine - Chipbreaker Guide

BASIC CHIPBREAKERS: POSITIVE INSERTS

N Non-ferrous Metal

Chipbreaker System for Turning (Positive Inserts)

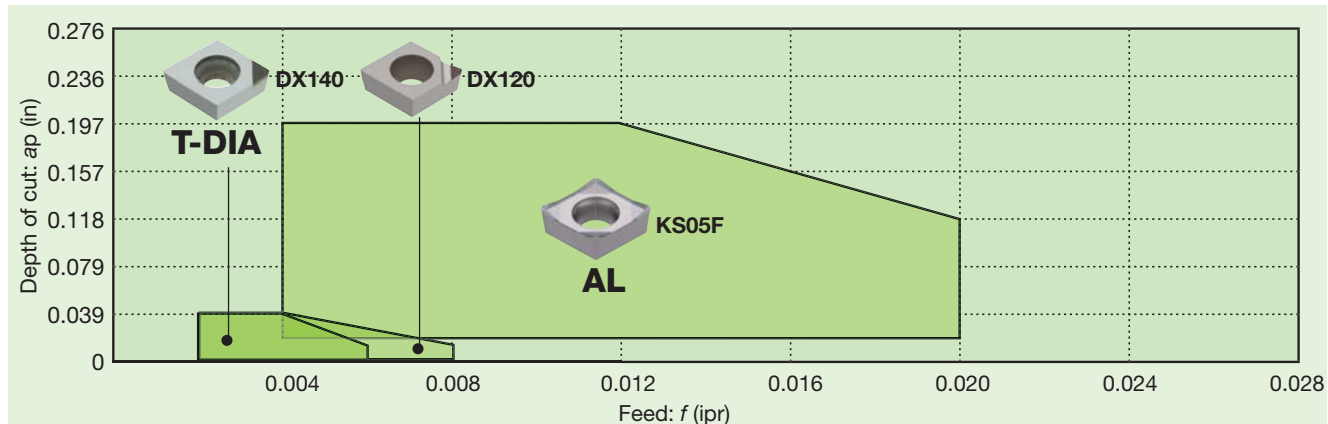

Aluminum alloys (Si < 12%)

Aluminum alloys (Si ≥ 12%)

Copper alloys

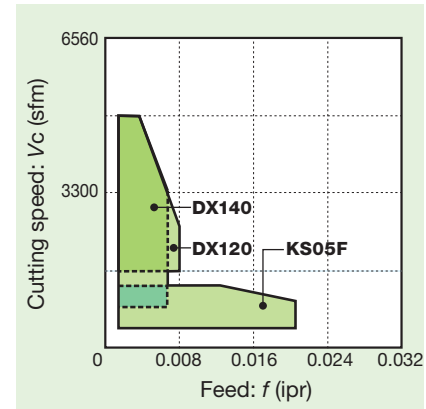
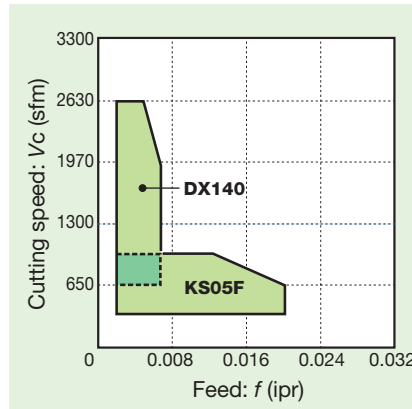
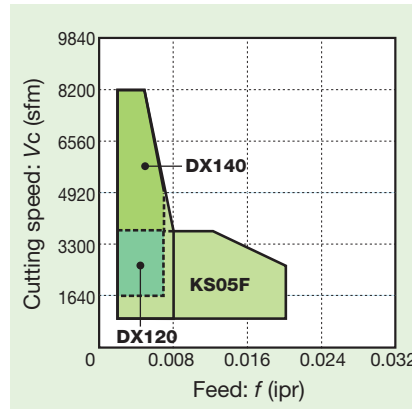

Chipbreaker	Appearance	Features
No chip-breaker (T-DIA)		Performs well in high speed finishing of non-ferrous materials.
AL		Extremely sharp cutting edge. Polished surface. Excellent chip forming at high cutting feeds. Low power consumption.

Chipbreaker	Appearance	Features
With chip-breaker (T-DIA)		The wide chipbreaker width contributes to excellent chip control.

STANDARD CUTTING CONDITIONS

ISO	Operation	Work condition	Chip-breaker	Grade	Depth of cut ap (in)	Feed f (ipr)	Cutting speed: Vc (sfm)		
							Aluminum alloys (Si < 12%)	Aluminum alloys (Si > 12%)	Copper alloys
N	Precision finishing	Continuous	With	DX120	0.002 - 0.040	0.002 - 0.006	1640 - 8200	1310 - 2630	1640 - 4920
		Light interrupted	Without	DX140	0.002 - 0.040	0.002 - 0.008	980 - 8200	-	1640 - 4920
	Finishing	Continuous	Without	DX140	0.002 - 0.040	0.002 - 0.006	1640 - 8200	1310 - 2630	1640 - 4920
		Light interrupted	Without	DX140	0.002 - 0.040	0.002 - 0.006	980 - 5900	1310 - 1970	1310 - 3940
		Heavy interrupted	AL	KS05F	0.020 - 0.197	0.004 - 0.020	330 - 1970	330 - 660	-
		Continuous	AL	KS05F	0.020 - 0.197	0.004 - 0.020	330 - 3940	330 - 980	330 - 980
Medium cutting	Light interrupted	AL	KS05F	0.020 - 0.197	0.004 - 0.020	330 - 2950	330 - 660	330 - 660	
	Heavy interrupted	AL	KS05F	0.020 - 0.197	0.004 - 0.020	330 - 1970	330 - 660	-	

TurnLine - Selection System



Insert

SELECTION SYSTEM: POSITIVE INSERTS

N Non-ferrous Metal

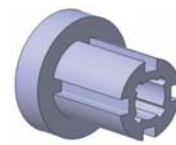
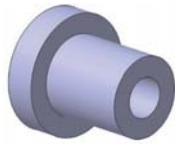

	Continuous	Light interrupted	Heavy interrupted
Precision finishing [$a_p = \sim 0.020$ in]	<p>Basic</p> <p>With chipbreaker DX120</p> <p>Wear</p> <p>T-DIA DX140</p>	<p>Basic</p> <p>With chipbreaker DX120</p> <p>Wear</p> <p>T-DIA DX140</p>	
Finishing [$a_p = 0.020 \sim 0.079$ in]	<p>Basic</p> <p>T-DIA DX140</p> <p>Wear</p> <p>Chip control</p> <p>T-DIA DX160</p> <p>With chipbreaker T-DIA DX120</p>	<p>Basic</p> <p>T-DIA DX140</p> <p>Fracture</p> <p>Wear</p> <p>AL KS05F</p> <p>T-DIA DX160</p>	<p>Basic</p> <p>AL KS05F</p>
Medium cutting [$a_p = 0.039 \sim 0.197$ in]	<p>Basic</p> <p>AL KS05F</p> <p>Wear</p> <p>With chipbreaker T-DIA DX120</p>	<p>Basic</p> <p>AL KS05F</p> <p>Wear</p> <p>T-DIA DX140</p>	<p>Basic</p> <p>AL KS05F</p>



TurnLine - Chipbreaker Guide

BASIC CHIPBREAKERS: POSITIVE INSERTS

S Superalloys and titanium

Chipbreaker System for Turning (Positive Inserts)

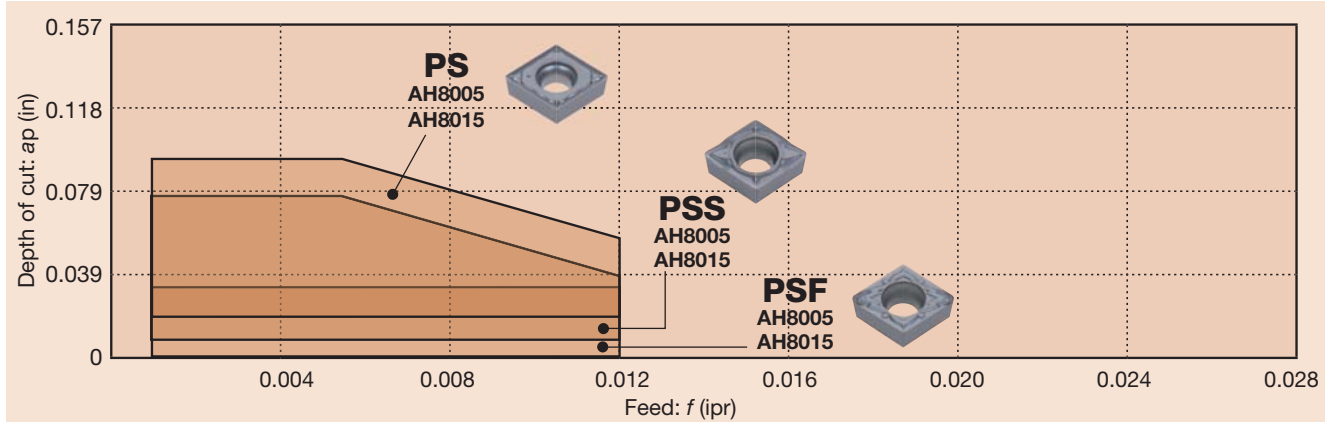

Titanium alloys

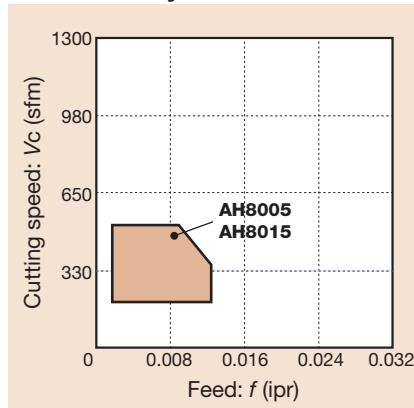

Ni-base alloys

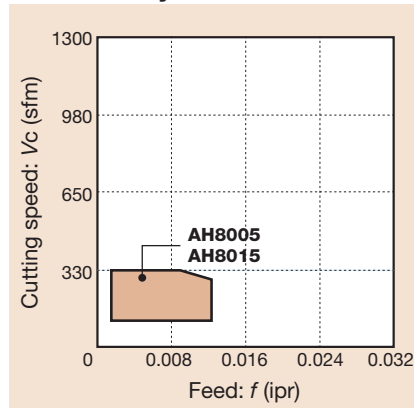

Chipbreaker	Appearance	Features
PS		3-dimensional chipbreaker designed to have excellent chip control capability and low cutting force in finishing to medium cutting. Low cost, M-class positive insert used for high efficiency boring in a wide range of applications.

Chipbreaker	Appearance	Features
PSF		Developed chipbreaker for finishing at low cutting depths. Optimal chip control due to pre-positioned chipbreaker element.
PSS		3-dimensional chipbreaker designed to have excellent chip control capability and low cutting force in finishing to medium cutting. Low cost, M-class positive insert used for high efficiency boring in a wide range of applications.

STANDARD CUTTING CONDITIONS

ISO	Operation	Work condition	Chip-breaker	Grade	Depth of cut a_p (in)	Feed f (ipr)	Cutting speed: V_c (sfm)	
							Titanium alloys	Ni-base alloys
S	Finishing	Continuous	PSS	AH8015	0.012 - 0.079	0.001 - 0.012	66 - 500	66 - 330
		Light interrupted	PSS	AH8015	0.012 - 0.079	0.001 - 0.012	66 - 500	66 - 330
	Finishing to medium cutting	Continuous	PS	AH8015	0.020 - 0.098	0.001 - 0.012	66 - 500	66 - 330
		Light interrupted	PS	AH8015	0.020 - 0.098	0.001 - 0.012	66 - 500	66 - 330

Ni-base alloys: INCONEL718 etc.

Titanium alloys: Ti - 6Al - 4V etc.

TurnLine - Selection System



Insert

SELECTION SYSTEM: POSITIVE INSERTS

S Superalloys and titanium

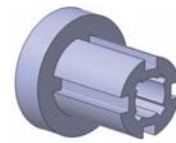
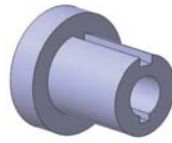
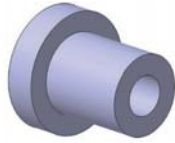

Continuous

Light interrupted

Heavy interrupted

Finishing
[$a_p = 0.012 \sim 0.079$ in]



PSS AH8005



PSS AH8005



PS AH8015

Finishing to medium cutting
[$a_p = 0.020 \sim 0.098$ in]



PSS AH8005



All-round AH8015



All-round AH8015



TurnLine - Chipbreaker Guide

BASIC CHIPBREAKERS: POSITIVE INSERTS

H Hard Materials

Chipbreaker System for Turning (Positive Inserts)

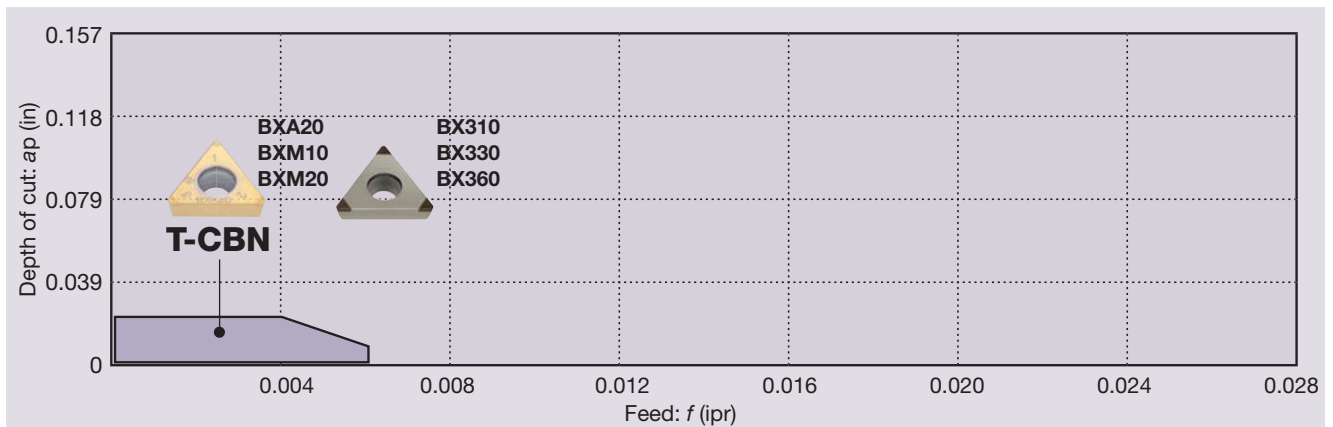

Coated T-CBN

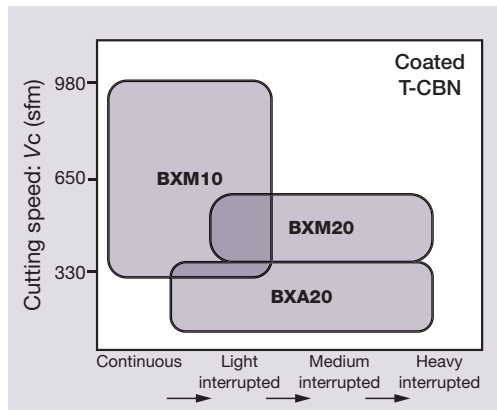

T-CBN

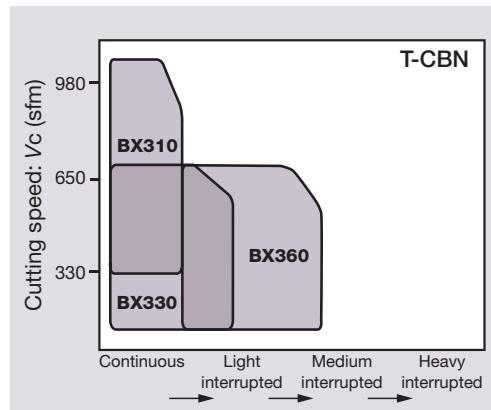

Chipbreaker	Appearance	Features
No chip-breaker (T-CBN)		Performs well in finishing of hardened steel.

STANDARD CUTTING CONDITIONS

ISO	Operation	Work condition	Chipbreaker	Grade	Depth of cut ap (in)	Feed f (ipr)	Cutting speed Vc (sfm)
H	Precision finishing	Continuous	No chipbreaker (T-CBN)	BXM10	0.002 - 0.012	0.001 - 0.006	500 - 1150
		Light interrupted	No chipbreaker (T-CBN)	BXM20 BXA20	0.002 - 0.012	0.001 - 0.006	230 - 720
	Finishing	Continuous ~ interrupted	No chipbreaker (T-CBN)	BXM20 BXA20	0.003 - 0.020	0.002 - 0.012	230 - 720

Hardened steels, Pre-hardened steels: D2, H13, etc.

TurnLine - Selection System



Insert

SELECTION SYSTEM: POSITIVE INSERTS



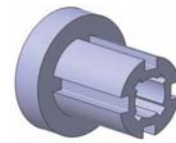
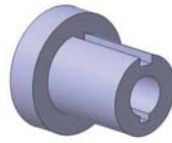
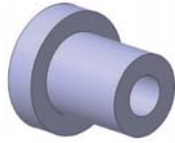

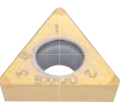









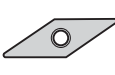

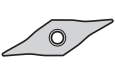
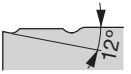
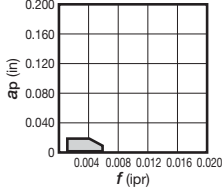
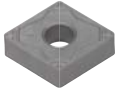
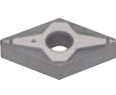

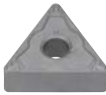
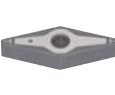

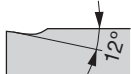
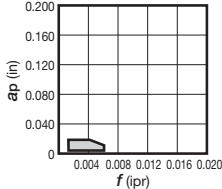
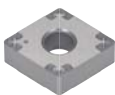
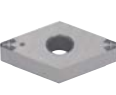

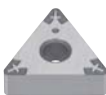

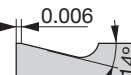
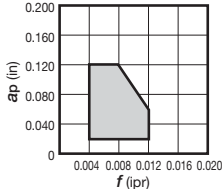
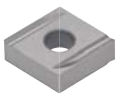



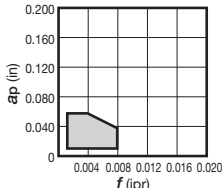

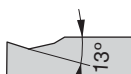
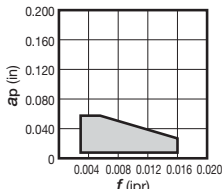





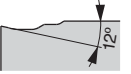
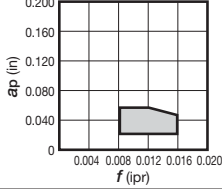



H Hard Materials

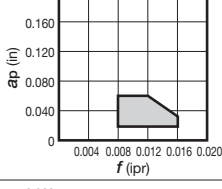

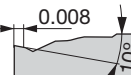
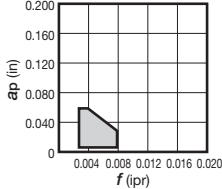
	Continuous	Light interrupted	Heavy interrupted
Precision finishing [$a_p \sim 0.012$ in]	<p>Basic</p>  <p>T-CBN BXM10</p>	<p>Basic</p>  <p>T-CBN BXM20</p> <p>Fracture → T-CBN BXA20</p> <p>For high speed Wear → T-CBN BXM10</p>	
Finishing [$a_p \sim 0.020$ in]	<p>Basic</p>  <p>T-CBN BXM10</p>	<p>Basic</p>  <p>T-CBN BXM20</p> <p>Fracture → T-CBN BXA20</p> <p>For high speed Wear → T-CBN BXM10</p>	<p>Basic</p>  <p>T-CBN BXM20</p> <p>Fracture → T-CBN BXA20</p>



TurnLine - Chipbreaker Overview











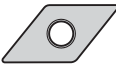

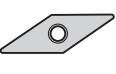

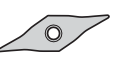

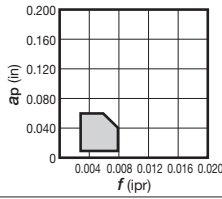
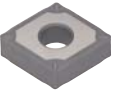
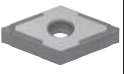

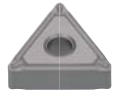
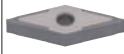
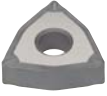
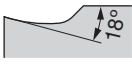
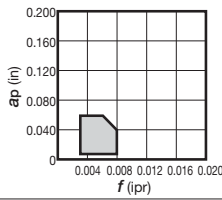





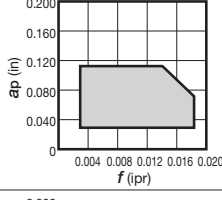
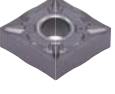

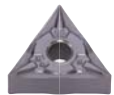

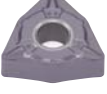

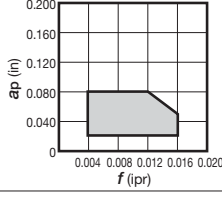







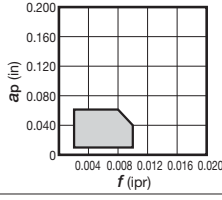



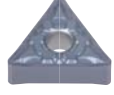

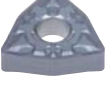

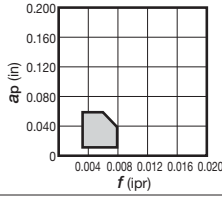
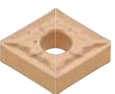

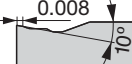
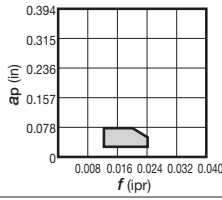

Application	Negative type with hole	C	D	S	T	V	W	Y
								
		80°	55°	90°	60°	35°	80°	25°
Precision finishing	TF  	 B052	 B063	 B073	 B082	 B093	 B097	
	01  	 B052	 B063	 B073	 B082	 B093	 B097	
	A~D  	 B052		 B073	 B082, B083			
	W  				 B083			
Finishing	TSF  	 B052	 B063	 B073	 B083	 B093	 B097	
	FW  	 B052	 B063		 B083		 B097	
Finishing (Wiper)	AFW  	 B052					 B097	
	ZF  	 B053	 B063		 B083	 B093	 B097	 B104

The page number for the product details is shown in red.

TurnLine - Chipbreaker Overview

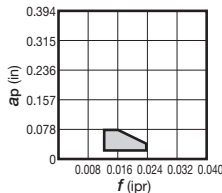

Insert

Application	Negative type with hole	C	D	S	T	V	W	Y	
									
		80°	55°	90°	60°	35°	80°	25°	
Finishing	11  	 B053	 B064	 B074	 B084	 B093	 B098		
	17  	 B053	 B064	 B074	 B084		 B098		
Finishing	SF  	 B053	 B064	 B074	 B084	 B093	 B098		
	CF  	 B053	 B064	 B074	 B084	 B094	 B098		
	HRF  	 B053	 B064	 B074	 B084	 B094	 B098		
	TS  	 B054	 B065	 B075	 B085	 B094	 B098		
	Finishing to medium cutting (Wiper)	SW  	 B054	 B065		 B085		 B099	
		ASW  	 B054						 B099

The page number for the product details is shown in red.



TurnLine - Chipbreaker Overview

Application	Negative type with hole	C	D	S	T	V	W	Y
		80°	55°	90°	60°	35°	80°	25°
High feed, small depth of cut	AS 0.394, 0.315, 0.236, 0.157, 0.078, 0 0.008 0.016 0.024 0.032 0.040							
	B054	B065	B075	B085		B099		
Boring (Double sided)	CB 0.200, 0.160, 0.120, 0.080, 0.040, 0 0.004 0.008 0.012 0.016 0.020							
	B054	B065		B085		B099		
Finishing	NS 0.200, 0.160, 0.120, 0.080, 0.040, 0 0.004 0.008 0.012 0.016 0.020							
	B055	B065	B075	B085		B099		
	SS 0.200, 0.160, 0.120, 0.080, 0.040, 0 0.004 0.008 0.012 0.016 0.020							
	B055	B066	B075	B086	B094	B099		
Medium cutting	TM 0.394, 0.315, 0.236, 0.157, 0.078, 0 0.008 0.016 0.024 0.032 0.040							
	B055	B066	B075	B086	B094	B100		
Finishing to medium cutting	AM 0.394, 0.315, 0.236, 0.157, 0.078, 0 0.008 0.016 0.024 0.032 0.040							
	B055	B066		B086		B100		
	NM 0.200, 0.160, 0.120, 0.080, 0.040, 0 0.004 0.008 0.012 0.016 0.020							
	B055	B066		B086		B100		
TQ 0.200, 0.160, 0.120, 0.080, 0.040, 0 0.004 0.008 0.012 0.016 0.020								
B056	B067		B086	B095	B100			

The page number for the product details is shown in red.

TurnLine - Chipbreaker Overview













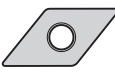



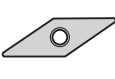

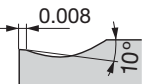
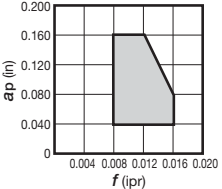



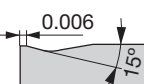
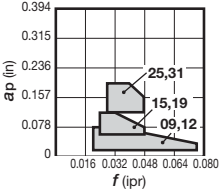

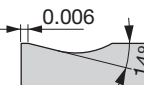
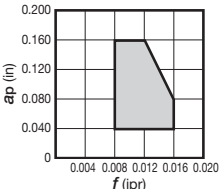
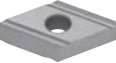
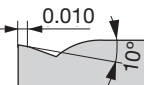
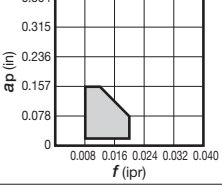





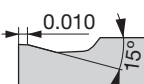
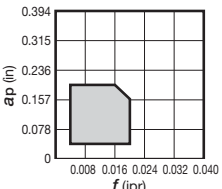
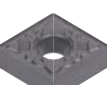





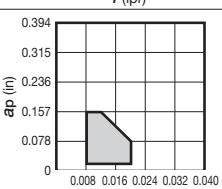





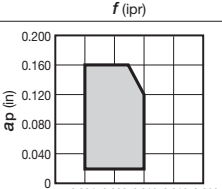

Insert

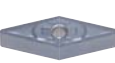
Application		Negative type with hole	C	D	S	T	V	W	Y
			80°	55°	90°	60°	35°	80°	25°
Finishing to medium cutting	ZM	 							
			B056	B067	B076	B087	B095	B100	B104
Medium cutting	DM	 							
			B056	B067	B076	B087	B095	B101	
			B056	B067	B076	B087	B095	B101	
Finishing to medium cutting	27	 							
			B057	B067	B076	B087		B101	
Medium cutting	28	 							
			B057	B068		B088	B095		
						B088			
Medium cutting	32	 							
						B088			
Medium cutting	33	 							
			B057	B068		B088	B095	B101	
Medium cutting	37	 							
			B057	B068	B077	B088		B101	

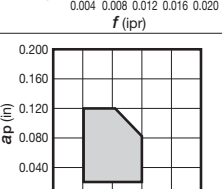
The page number for the product details is shown in red.



TurnLine - Chipbreaker Overview















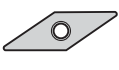

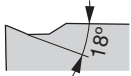
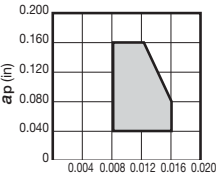





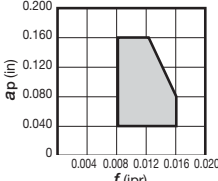



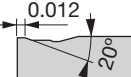
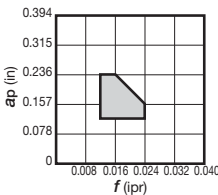





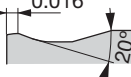
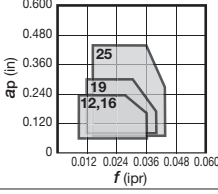

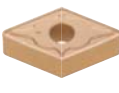



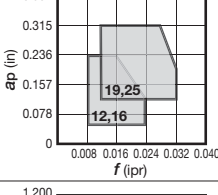

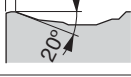
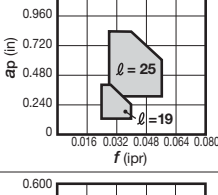

Application	Negative type with hole	C	D	R	S	T	V	W
		 80°	 55°		 90°	 60°	 35°	 80°
Medium cutting	38  0.008 10° 	 B057	 B068			 B088		
	61  0.006 15° 			 B072				
Medium cutting (Single sided)	Parallel  0.006 14° 		 B068					
	SM  0.010 10° 	 B058	 B068		 B077	 B088	 B096	 B102
	CM  0.010 15° 	 B058	 B069		 B077	 B088	 B096	 B102
	P  30° 	 B058	 B069		 B077	 B089	 B093	
	HRM  0.010 15° 	 B058	 B069		 B077	 B089	 B096	 B102
	HMM  0.010 15° 	 B058	 B069		 B078	 B089	 B096	 B102

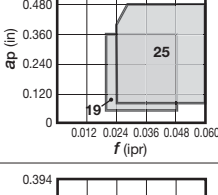
The page number for the product details is shown in red.

TurnLine - Chipbreaker Overview

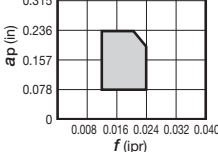

Insert

Application	Negative type with hole	C	D	R	S	T	V	W
		 80°	 55°		 90°	 60°	 35°	 80°
Medium cutting	SA  							
	B059	B069		B078	B089		B102	
Medium to heavy cutting	S  							
	B059	B069		B078	B090			
Medium to heavy cutting	TH  							
	B059	B070		B078	B090		B103	
Medium to heavy cutting	THS  							
	B059	B070		B078	B090		B103	
Medium to heavy cutting (Single sided)	TRS  							
B060			B079					
Heavy cutting (Single sided)	TU  							
	B060			B079				
Heavy cutting	TUS  							
	B060			B079				
Medium to heavy cutting	SH  							
B060	B070		B079				B103	

The page number for the product details is shown in red.



TurnLine - Chipbreaker Overview

Application		Negative type with hole						
		C	D	R	S	T	V	W
		80°	55°		90°	60°	35°	80°
Medium to heavy cutting	CH 							
		B060	B070		B079	B090		B103
Finishing to medium cutting	M,G-class 							
		B061	B070	B072	B080	B091	B096	B103
Finishing to heavy cutting	Wiper M-class 							
		B061						











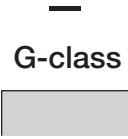
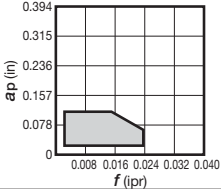

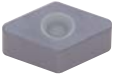

Application		Negative type without hole						
		C	D	KNMX	LNGN	R	S	T
		80°	55°	55°	90°		90°	60°
Finishing	S1 							
				B105				

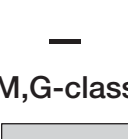
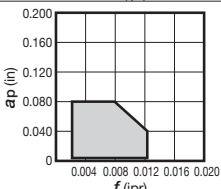
The page number for the product details is shown in red.

TurnLine - Chipbreaker Overview

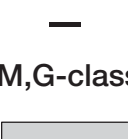
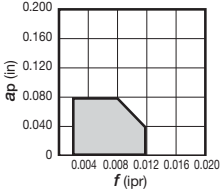

Insert

Application	Negative type without hole	C	D	H	R	S	T	V
		80°	55°	120°		90°	60°	35°
Finishing to medium cutting	G-class  	 B062	 B071	 B105		 B081		 B096
	M,G-class  	 B062	 B071		 B072	 B081	 B092	
Finishing to roughing	M,G-class  		 B071			 B081		

The page number for the product details is shown in red.



Insert

TurnLine - Chipbreaker Overview











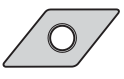



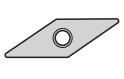
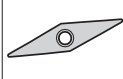
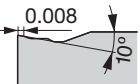
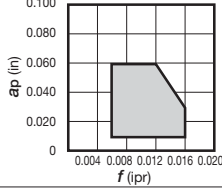

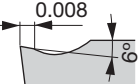
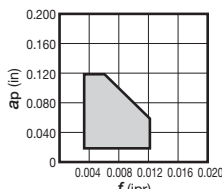
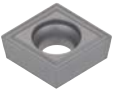

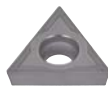

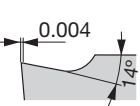
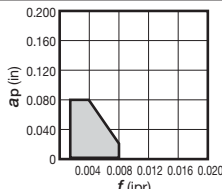
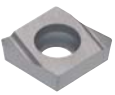
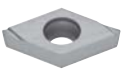

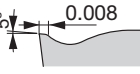
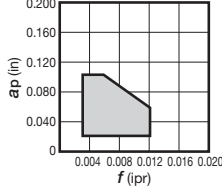

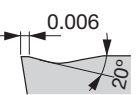
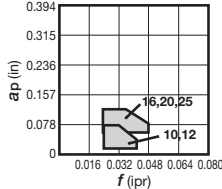

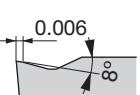
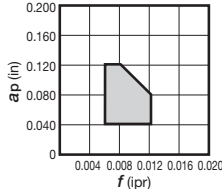
Application		Positive 7° with hole						
		C	D	R	S	T	V	Y
		80°	55°		90°	60°	35°	25°
Precision finishing	01 	 B106	 B116			 B133		
	PSF 	 B106	 B116			 B133	 B149	
	PF 	 B106	 B116				 B149	
Finishing to light cutting	PSS 	 B107	 B117			 B133	 B149	
	PS 	 B107	 B117		 B129	 B134	 B149	
Finishing to medium cutting	ZF 							 B155
	ZM 							 B155
	23 	 B107	 B117		 B129	 B134		

The page number for the product details is shown in red.

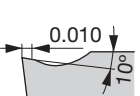
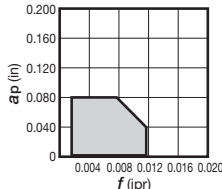
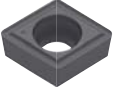
TurnLine - Chipbreaker Overview

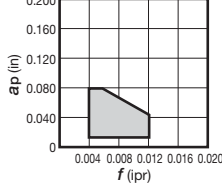
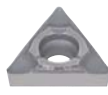

Insert

Application	Positive 7° with hole	C	D	R	S	T	V	Y
								
		80°	55°		90°	60°	35°	25°
Finishing to medium cutting Wiper	SW  	 B107						
Medium cutting	24  	 B107	 B117		 B129	 B134	 B150	
Finishing	W**  	 B108, B109	 B118			 B134		
Finishing to medium cutting	RS  			 B126				
Heavy cutting	61  			 B127				
Medium cutting	PM  	 B109	 B118		 B129	 B135		
Finishing to medium cutting	CM  	 B109	 B118	 B126	 B129	 B135	 B150	
Finishing to medium cutting	SS  					 B135		

The page number for the product details is shown in red.



Insert

TurnLine - Chipbreaker Overview











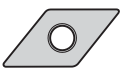



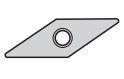
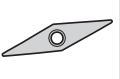
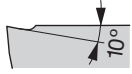
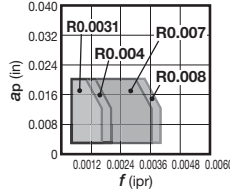
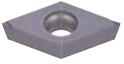

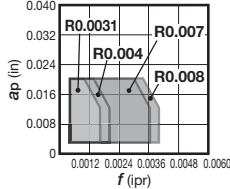
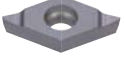
Application	Positive 7° with hole	C	D	R	S	T	V	Y	
		80°	55°		90°	60°	35°	25°	
Finishing to medium cutting	AL 0.394, 0.315, 0.236, 0.157, 0.078, 0 0.008, 0.016, 0.024, 0.032, 0.040								
	B110	B119	B126		B135	B150			
	All-round 0.200, 0.160, 0.120, 0.080, 0.040, 0 0.004, 0.008, 0.012, 0.016, 0.020								
	B110	B119				B150			
Angular 0.200, 0.160, 0.120, 0.080, 0.040, 0 0.004, 0.008, 0.012, 0.016, 0.020									
B110	B119								
M,G-class 0.200, 0.160, 0.120, 0.080, 0.040, 0 0.004, 0.008, 0.012, 0.016, 0.020									
B110	B119								
Finishing	 0.200, 0.160, 0.120, 0.080, 0.040, 0 0.004, 0.008, 0.012, 0.016, 0.020								
						B136			
For external turning on small lathes (Sharp edge)	JS 0.200, 0.160, 0.120, 0.080, 0.040, 0 0.002, 0.004, 0.006, 0.008, 0.010 R0.004, R0.016, R0.008, R0.0012								
		B111	B120			B136			
For internal turning on small lathes (Sharp edge)	JS 0.040, 0.032, 0.024, 0.016, 0.008, 0 0.0016, 0.0032, 0.0048, 0.0064, 0.0080 R0.004, R0.008, R0.016								
		B111							
For external turning on small lathes (Sharp edge)	JPP 0.040, 0.032, 0.024, 0.016, 0.008, 0 0.0012, 0.0024, 0.0036, 0.0048, 0.0060 R0.0031, R0.004, R0.007, R0.008								
			B120						

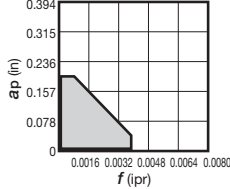
The page number for the product details is shown in red.

TurnLine - Chipbreaker Overview

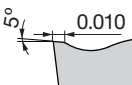
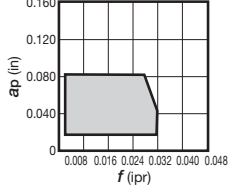

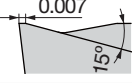
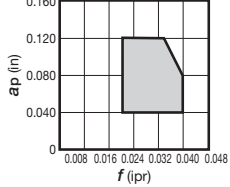













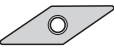
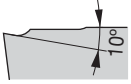
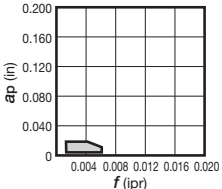

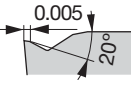
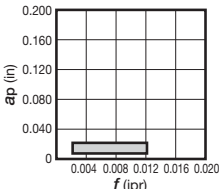

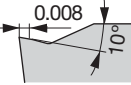
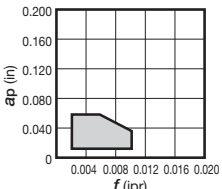
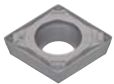
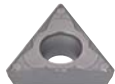
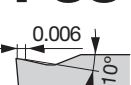
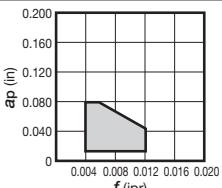
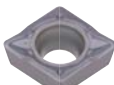
Insert

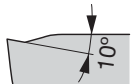
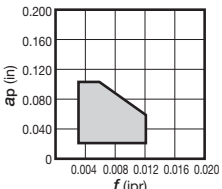
Application	Positive 7° with hole	C	D	R	S	T	V	Y
								
		80°	55°		90°	60°	35°	25°
For external turning on small lathes (Sharp edge)	JRP  		 B121					
	JSP  		 B121					
	J**  	 B112	 B121			 B136, B137		
Low cutting force	6RS  			 B270				
General use	6RM  			 B270				

The page number for the product details is shown in red.

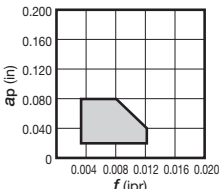

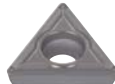
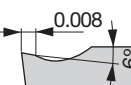
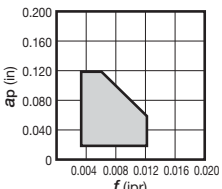
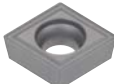
TurnLine - Chipbreaker Overview

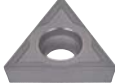
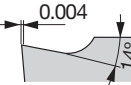
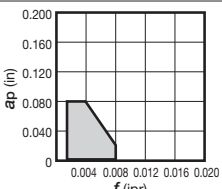
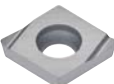
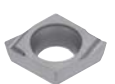
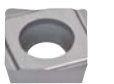
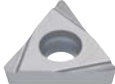













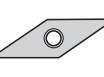
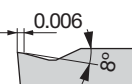
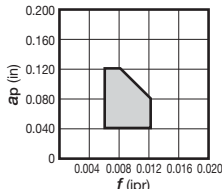

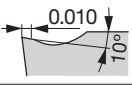
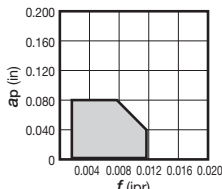

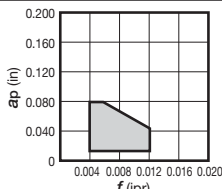

Application	Positive 11° with hole	C	E	S	T	V
						
		80°	75°	90°	60°	35°
Precision finishing	01  					
					B138	
Finishing	PSF  					
		B113			B138	
	PF  					
		B113			B138	
Finishing to light cutting	PSS  					
		B113			B139	
Finishing to medium cutting	PS  					
		B113		B130	B139	
	23  					
			B130	B139		
Medium cutting	24  					
		B114		B130	B140	
Finishing	W**  					
		B114	B124	B130	B140, B141	

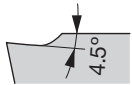
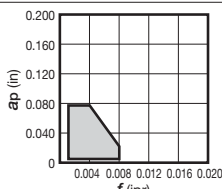
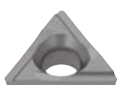
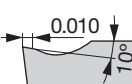
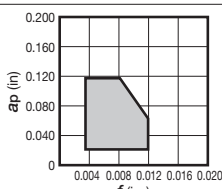
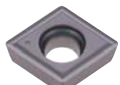
The page number for the product details is shown in red.

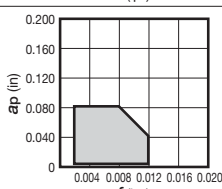
TurnLine - Chipbreaker Overview



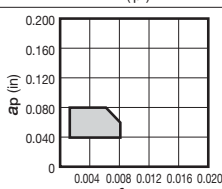

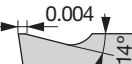
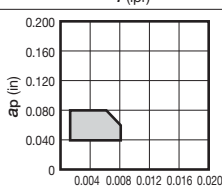
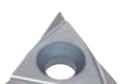











Insert

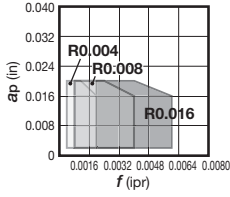
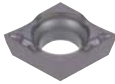
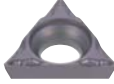

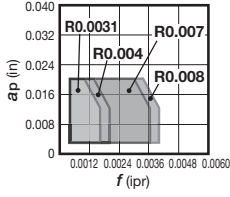
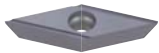

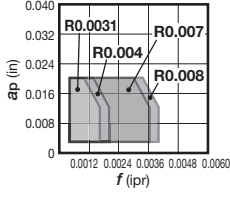
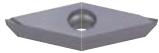
Application	Positive 11° with hole	C	E	S	T	V
						
		80°	75°	90°	60°	35°
Medium cutting	PM  	 B115			 B142	
	CM  	 B115		 B131	 B142	
Finishing to medium cutting	SS  				 B142	
	H**  				 B143	
Medium cutting	All-round  	 B115				
Finishing to medium cutting	M,G-class  	 B115		 B131	 B143, B144	
	(with hand)  			 Former Tungaloy- standard hole Not ISO B131		
	(with hand)  				 Former Tungaloy- standard hole Not ISO B143	

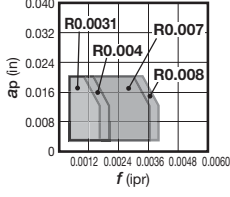
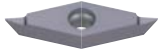
The page number for the product details is shown in red.

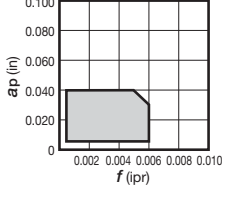
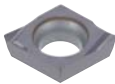

TurnLine - Chipbreaker Overview

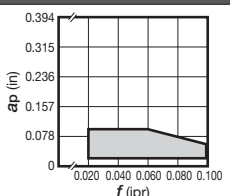
Application Positive 11° with hole		C	E	S	T	V
						
		80°	75°	90°	60°	35°
For internal turning on small lathes	JS  					
	JPP  					
	JRP  					
	JSP  					
Finishing	J08  					

Application Positive 11° with hole		W
		
		80°
Heavy cutting	ML  	 B152

The page number for the product details is shown in red.

TurnLine - Chipbreaker Overview





Insert



Application	Positive 5° with hole	V	W	Application	Positive 5° with hole	V	W
		35°	80°			35°	80°
Finishing	PSF <p style="text-align: center;">B147</p>			24 <p style="text-align: center;">B147</p>			
	PF <p style="text-align: center;">B147</p>			CM <p style="text-align: center;">B147</p>			
Finishing to light cutting	PSS <p style="text-align: center;">B147</p>			JS <p style="text-align: center;">B148</p>			
Finishing to medium cutting	PS <p style="text-align: center;">B147</p>			JS <p style="text-align: center;">B153</p>			
Finishing	W08 <p style="text-align: center;">B153</p>			J10 <p style="text-align: center;">B148</p>			
	W11 <p style="text-align: center;">B153</p>			J10 <p style="text-align: center;">B148</p>			

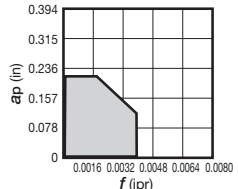

The page number for the product details is shown in red.



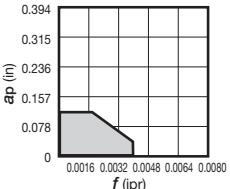

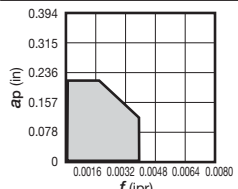

TurnLine - Chipbreaker Overview

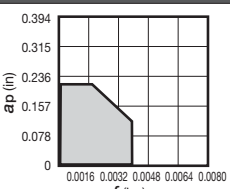

Application	Positive with hole	JXF 
Front-turning Insert		 B156

Application	Positive with hole	J10E 
Back-turning Insert		 B157, B158

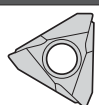
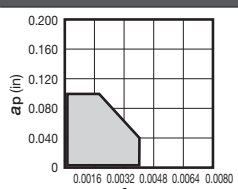
Application	Positive with hole	JXB 
Back-turning Insert		 B156

Application	Positive with hole	JXR 
Reverse-turning Insert		 B156

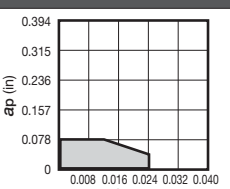
Application	Positive with hole	JTB 
Back-turning Insert		 B157











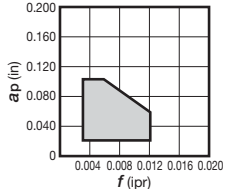



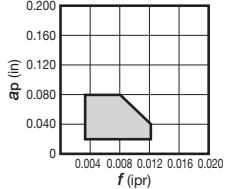

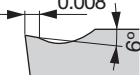
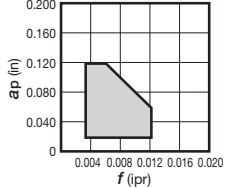

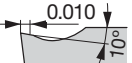
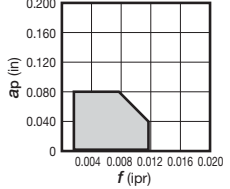
Application	Positive without hole	RT 
Medium cutting		Special round insert  B127

The page number for the product details is shown in red.

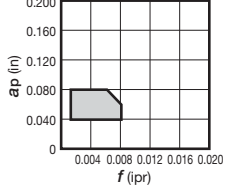
TurnLine - Chipbreaker Overview

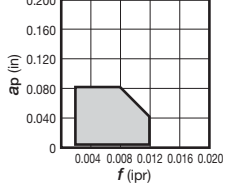

Insert











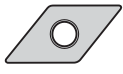
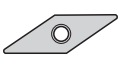

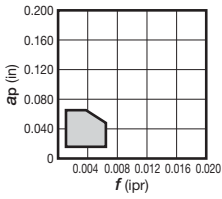

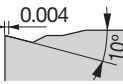
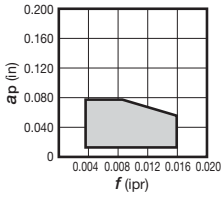
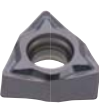
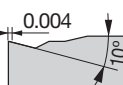
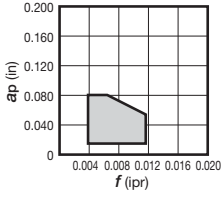
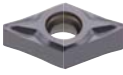
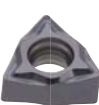

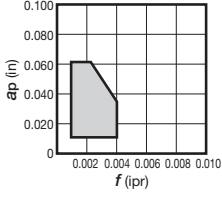
Application	Positive 11° without hole	S	T
		90°	60°
Finishing to medium cutting	PS  		  B145
	23  	 B132	 B145
Medium cutting	24  		 B145
Finishing to medium cutting	CM  	 B132	 B145
	I (with hand)  	 B132	 B146
	M,G-class  	 B132	 B146

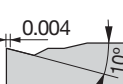
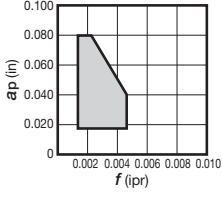
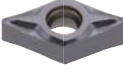
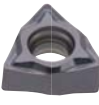
The page number for the product details is shown in red.

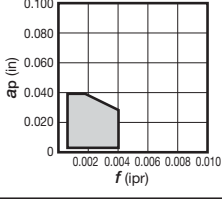
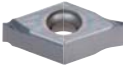

Insert

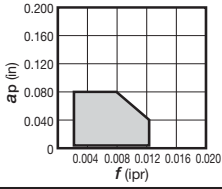
TurnLine - Chipbreaker Overview

Application		Chipbreaker		
		D	V	W
Positive, double-sided		 55°	 35°	 80°
Finishing (Low cutting force)	<p>SS</p>  	 B123		 B154
Finishing (Wiper)	<p>TSW</p>  			 B154
Finishing to medium cutting	<p>TS</p>  	 B123		 B154
Finishing (Low cutting force) (sharp edge)	<p>JSS</p>  	 B122, B123		 B154
Finishing to medium cutting (sharp edge)	<p>JTS</p>  	 B122		 B154
Finishing (sharp edge)	<p>JRP</p>  	 B122	 B152	
Application	<p>Chipbreaker Positive, without hole</p>	<p>RCGX </p> <p>Special round insert</p>		
Medium cutting	<p>I</p>  	 B128		

The page number for the product details is shown in red.

JRP / JPP / JSP High Tolerance Inserts



Insert

Ground chipbreakers (Sharp edge)

JRP type

Lead (Ramp) type chipbreaker
For excellent chip control

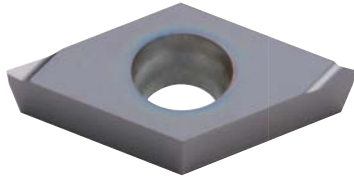

JPP type

Parallel type chipbreaker
Good chip evacuation
For profiling

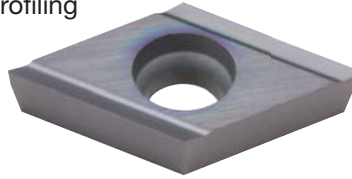

JSP type

Neutral (symmetric) type chipbreaker

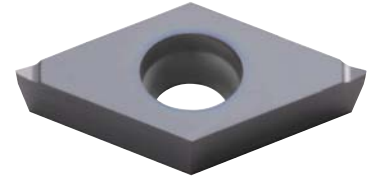

Tolerance of inserts

Tolerance of corner radius: $0 - -0.02 \text{ mm (0.0008")}$
(Minus tolerance)

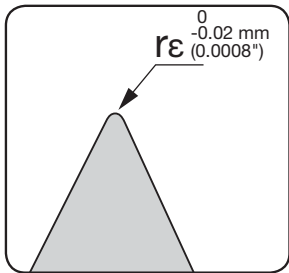

Height of cutting edge: $\pm 0.025 \text{ mm (0.001")}$

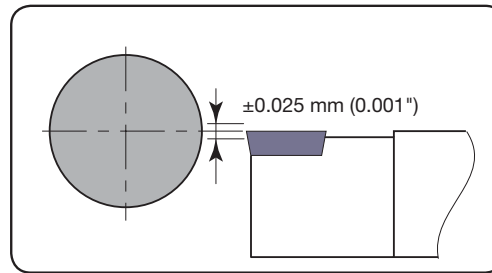

JS 3 dimensional chipbreaker

Excellent cutting performance for superalloys

Dynamic inclination

- Improved chip control
- Low cutting force prevents dimensional changes

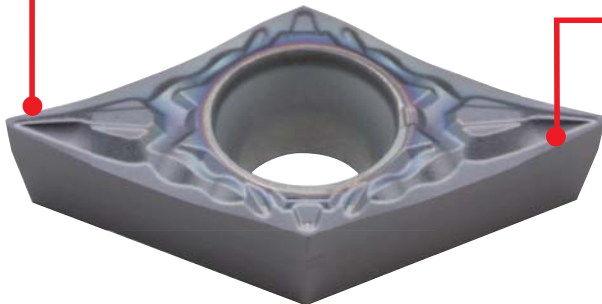

Steep protrusion

- Improved chip coiling for profile turning



Insert

TurnLine - Insert

● : Continuous cutting
 ● : Light interrupted cutting
 * : Heavy interrupted cutting

NEGATIVE TYPE



Rhombic, 80° with hole

	P	M	K	N	S	H
Steel	● ● ● ● ● *					
Stainless		● ● ● ● ● *				
Cast iron	● ● ● ● ● *		● ● ● ● ● *			
Non-ferrous				● ● ● ● ● *		
Superalloys					● ● ● ● ● *	
Hard materials						● ● ● ● ● *

Negative

Application	Chipbreaker	Designation		Corner radius	Coated							Coated cermet	Cermets		Uncoated						
		Inch	Metric		T9105	T9115	T9125	T9135	T6130	AH110	AH120	GH110	GT9530	NS9530	NS520	TH10					
Application		TF	CNMG 431 TF	CNMG120404-TF	0.016"	●	●	●	●	●	●	●	●	●	●	●	●	●	●		
			CNMG 432 TF	CNMG120408-TF	0.031"																
Precision finishing		01	CNGG 320.5-01	CNGG090302-01	0.008"								●								
			CNGG 321-01	CNGG090304-01	0.016"									●							
			CNGG 322-01	CNGG090308-01	0.031"									●							
			CNGG 430-01	CNGG120401-01	0.004"						●										
			CNGG 430.5-01	CNGG120402-01	0.008"						●				●	●			●		
			CNGG 431-01	CNGG120404-01	0.016"						●				●	●			●		
			CNGG 432-01	CNGG120408-01	0.031"						●				●	●			●		
Application		C	CNGG 431 R-C	CNGG120404R-C	0.016"									●							
			CNGG 431 L-C	CNGG120404L-C	0.016"										●						
			CNGG 432 R-C	CNGG120408R-C	0.031"										●						
			CNGG 432 L-C	CNGG120408L-C	0.031"										●						
Finishing		TSF	CNMG 331E TSF	CNMG090404E-TSF	0.016"		●	●				●		●							
			CNMG 332E TSF	CNMG090408E-TSF	0.031"			●	●				●		●						
			CNMG 431 TSF	CNMG120404-TSF	0.016"	●	●	●		●	●		●		●						
			CNMG 432 TSF	CNMG120408-TSF	0.031"	●	●	●	●	●	●		●		●						
			CNMG 433 TSF	CNMG120412-TSF	0.047"	●	●	●			●										
Finishing (Wiper)		FW	CNMG331E-FW	CNMG090404E-FW	0.016"	●	●	●				●		●							
			CNMG332E-FW	CNMG090408E-FW	0.031"	●	●	●				●		●							
			CNMG431-FW	CNMG120404-FW	0.016"		●						●		●						
			CNMG432-FW	CNMG120408-FW	0.031"	●	●	●					●		●						
Finishing (Wiper)		AFW	CNMG 431 AFW	CNMG120404-AFW	0.016"		●	●				●		●							
			CNMG 432 AFW	CNMG120408-AFW	0.031"	●	●	●	●				●								

● : Line up

Reference pages

External toolholders → **B202** -
 J series toolholders → **B376**

Internal toolholders → **B294** -
 TungCap → **B223** -, **F006** -

TurnLine - Insert

● : Continuous cutting
 ● : Light interrupted cutting
 * : Heavy interrupted cutting

NEGATIVE TYPE



Rhombic, 80°
with hole

P	Steel	●●	●●*	●●*	●	●*	●*					●●	●●	●●	●●	●●	●●	●●	●●
M	Stainless				●	●	●		●	●		●●	●●	●●	●●	●●	●●	●●	●●
K	Cast iron	●●										●●	●●	●●	●●	●●	●●	●●	●●
N	Non-ferrous																		●●
S	Superalloys																		●●
H	Hard materials																		

Application	Chipbreaker	Designation		Corner radius	Coated								Coated cermet		Cermet	Uncoated			
		Inch	Metric		T9115	T9125	T9135	T6120	T6130	AH630	T5105	T5115	AH8005	AH8015	GT9530	GT720	NS9530	TH10	
Finishing		ZF	CNMG331E-ZF	CNMG090404E-ZF	0.016"	●	●												
			CNMG 431 ZF	CNMG120404-ZF	0.016"	●	●							●		●			
			CNMG 432 ZF	CNMG120408-ZF	0.031"	●	●	●						●		●			
			CNMG 433 ZF	CNMG120412-ZF	0.047"	●													
Finishing		11	CNMG 431 11	CNMG120404-11	0.016"								●		●		●		
			CNMG 432 11	CNMG120408-11	0.031"									●	●	●		●	
Finishing of mild steels		17	CNMG 431 TN17	CNMG120404-17	0.016"											●			
			CNMG 432 TN17	CNMG120408-17	0.031"												●		
Finishing		SF	CNMG 321 SF	CNMG090304-SF	0.016"				●	●	●								
			CNMG 322 SF	CNMG090308-SF	0.031"				●	●	●								
			CNMG 431 SF	CNMG120404-SF	0.016"				●	●	●								
			CNMG 432 SF	CNMG120408-SF	0.031"				●	●	●								
			CNMG 433 SF	CNMG120412-SF	0.047"				●	●	●								
Finishing		CF	CNMG 431 CF	CNMG120404-CF	0.016"														
			CNMG 432 CF	CNMG120408-CF	0.031"														
			CNMG 433 CF	CNMG120412-CF	0.047"														
Finishing		HRF	CNMG 431 HRF	CNMG120404-HRF	0.016"									●	●				
			CNMG 432 HRF	CNMG120408-HRF	0.031"										●	●			
			CNMG 433 HRF	CNMG120412-HRF	0.047"											●	●		

● : Line up

Reference pages

External toolholders → **B202** -
 J series toolholders → **B376**

Internal toolholders → **B294** -
 TungCap → **B223** -, **F006** -



Insert

Negative

C



Insert

Negative

TurnLine - Insert

● : Continuous cutting
●c : Light interrupted cutting
* : Heavy interrupted cutting

NEGATIVE TYPE



Rhombic, 80°
with hole

P Steel	●	●●	●●c	●*	●*						●●		●●●●			
M Stainless						●										
K Cast iron	●●●●						●●	●			●●		●●●●			
N Non-ferrous																
S Superalloys																
H Hard materials																

Application	Chipbreaker	Designation		Corner radius	Coated							Coated cermet	Cermet				
		Inch	Metric		T9105	T9115	T9125	T9135	T6130	T515	T5115	GT9530	NS9530	NS520			
Finishing		TS	CNMG 431 TS	CNMG120404-TS	0.016"	●	●●	●●c	●*	●*			●●				
			CNMG 432 TS	CNMG120408-TS	0.031"	●	●	●	●	●			●	●	●		
			CNMG 433 TS	CNMG120412-TS	0.047"		●	●	●								
Finishing to medium cutting (Wiper)		SW	CNMG332E-SW	CNMG090408E-SW	0.031"	●	●	●									
			CNMG333E-SW	CNMG090412E-SW	0.047"	●	●	●									
			CNMG432-SW	CNMG120408-SW	0.031"	●	●	●			●	●					
			CNMG433-SW	CNMG120412-SW	0.047"	●	●	●			●	●					
Finishing to medium cutting (ASW)		ASW	CNMG 432 ASW	CNMG120408-ASW	0.031"	●	●	●						●			
			CNMG 433 ASW	CNMG120412-ASW	0.047"	●	●	●									
High feed, small depth of cut		AS	CNMG 431 AS	CNMG120404-AS	0.016"	●	●	●						●			
			CNMG 432 AS	CNMG120408-AS	0.031"	●	●	●	●					●			
			CNMG 433 AS	CNMG120412-AS	0.047"		●	●	●								
Boring (Double sided)		CB	CNMG 321 CB	CNMG090304-CB	0.016"									●			
			CNMG 322 CB	CNMG090308-CB	0.031"										●		

● : Line up

Reference pages

External toolholders → B202 -
J series toolholders → B376

Internal toolholders → B294 -
TungCap → B223 -, F006 -

TurnLine - Insert

● : Continuous cutting
 ● : Light interrupted cutting
 * : Heavy interrupted cutting

NEGATIVE TYPE

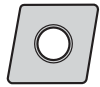

Rhombic, 80°
with hole

	P	M	K	N	S	H
Steel	● ● ● ● *	● ● ● ● *	● ● ● ● *	● ● ● ● *	● ● ● ● *	● ● ● ● *
Stainless	● ● ● ● *	● ● ● ● *	● ● ● ● *	● ● ● ● *	● ● ● ● *	● ● ● ● *
Cast iron	● ● ● ● *	● ● ● ● *	● ● ● ● *	● ● ● ● *	● ● ● ● *	● ● ● ● *
Non-ferrous	● ● ● ● *	● ● ● ● *	● ● ● ● *	● ● ● ● *	● ● ● ● *	● ● ● ● *
Superalloys	● ● ● ● *	● ● ● ● *	● ● ● ● *	● ● ● ● *	● ● ● ● *	● ● ● ● *
Hard materials	● ● ● ● *	● ● ● ● *	● ● ● ● *	● ● ● ● *	● ● ● ● *	● ● ● ● *

Application	Chipbreaker	Designation		Corner radius	Coated											Cermet												
		Inch	Metric		T9105	T9115	T9125	T9135	T6120	T6130	AH630	AH645	T515	AH110	AH120		AH725	AH8015	GH330	NS9530								
Finishing		NS	CNMG 431 NS	CNMG120404-NS	0.016"																				●			
			CNMG 432 NS	CNMG120408-NS	0.031"		●	●																		●		
		SS	CNMG 331E SS	CNMG090404E-SS	0.016"																							
			CNMG 332E SS	CNMG090408E-SS	0.031"																							
			CNMG 431 SS	CNMG120404-SS	0.016"					●	●	●	●				●											
		CNMG 432 SS	CNMG120408-SS	0.031"					●	●	●	●				●												
		CNMG 433 SS	CNMG120412-SS	0.047"					●	●	●	●																
Medium cutting		TM	CNMG 321 TM	CNMG090304-TM	0.016"		●	●																				
			CNMG 322 TM	CNMG090308-TM	0.031"		●	●	●																			
			CNMG 331E TM	CNMG090404E-TM	0.016"		●	●		●	●	●				●												
			CNMG 332E TM	CNMG090408E-TM	0.031"		●	●		●	●	●				●												
			CNMG 333E TM	CNMG090412E-TM	0.047"		●	●		●	●	●				●												
			CNMG 431 TM	CNMG120404-TM	0.016"		●	●	●	●	●	●	●			●												
			CNMG 432 TM	CNMG120408-TM	0.031"		●	●	●	●	●	●	●			●		●										
			CNMG 433 TM	CNMG120412-TM	0.047"		●	●	●	●	●	●	●			●		●										
			CNMG 434 TM	CNMG120416-TM	0.063"		●	●	●	●	●	●	●			●		●										
			CNMG 543 TM	CNMG160612-TM	0.047"		●	●	●	●						●												
			CNMG 642 TM	CNMG190608-TM	0.031"		●	●	●	●						●												
			CNMG 643 TM	CNMG190612-TM	0.047"		●	●	●	●						●												
		Finishing to medium cutting		AM	CNMG 432 AM	CNMG120408-AM	0.031"		●	●																		
	CNMG 433 AM			CNMG120412-AM	0.047"		●	●																				
	CNMG 434 AM			CNMG120416-AM	0.063"		●	●																				
	NM		CNMG 432 NM	CNMG120408-NM	0.031"		●	●	●	●																	●	
			CNMG 433 NM	CNMG120412-NM	0.047"		●	●	●																			

● : Line up

Reference pages

External toolholders → B202 -
 J series toolholders → B376

Internal toolholders → B294 -
 TungCap → B223 -, F006 -



Insert

Negative

C



Insert

TurnLine - Insert

● : Continuous cutting
● : Light interrupted cutting
* : Heavy interrupted cutting

NEGATIVE TYPE



Rhombic, 80°
with hole

P	Steel	●	●●●●	*	*					●	●●	●●●●	●●●●	●	
M	Stainless									●	●●			●	
K	Cast iron	●●●●		●●	●	●	*			●	●●	●●●●	●●●●	●	
N	Non-ferrous													●	
S	Superalloys									●	●●				
H	Hard materials														

Negative

Application	Chipbreaker	Designation		Corner radius	Coated										Coated cermet		Cermet		Uncoated		
		Inch	Metric		T9105	T9115	T9125	T9135	T515	T5105	T5115	T5125	AH110	AH120	GT9530	GT720	NS9530	NS520	TH10		
Finishing to medium cutting		TQ	CNMG 431 TQ	CNMG120404-TQ	0.016"											●		●			
			CNMG 432 TQ	CNMG120408-TQ	0.031"												●		●		
		ZM	CNMG 332E-ZM	CNMG090408E-ZM	0.031"	●	●														
			CNMG 432 ZM	CNMG120408-ZM	0.031"	●	●	●								●		●			
		CNMG 433 ZM	CNMG120412-ZM	0.047"	●	●	●								●						
		CNMG 434 ZM	CNMG120416-ZM	0.063"	●	●															
Medium cutting		DM	CNMG 431 DM	CNMG120404-DM	0.016"	●	●														
			CNMG 432 DM	CNMG120408-DM	0.031"	●	●	●	●												
			CNMG 433 DM	CNMG120412-DM	0.047"	●	●	●	●												
			CNMG 543 DM	CNMG160612-DM	0.047"			●													
		All-round	CNMG 321	CNMG090304	0.016"	●	●											●			
			CNMG 322	CNMG090308	0.031"	●	●	●	●							●		●			
			CNMG 431	CNMG120404	0.016"	●	●	●	●	●	●	●	●	●	●	●	●	●	●		●
			CNMG 432	CNMG120408	0.031"	●	●	●	●	●	●	●	●	●	●	●	●	●	●	●	●
			CNMG 433	CNMG120412	0.047"	●	●	●	●	●	●	●	●	●	●	●			●		●
			CNMG 434	CNMG120416	0.063"	●	●	●	●	●	●	●	●	●	●						
			CNMG 542	CNMG160608	0.031"	●	●	●	●		●	●	●	●	●						
			CNMG 543	CNMG160612	0.047"	●	●	●	●	●	●	●	●	●	●						
			CNMG 544	CNMG160616	0.063"	●	●	●	●	●	●	●	●	●	●						
		CNMG 642	CNMG190608	0.031"		●	●	●													
	CNMG 643	CNMG190612	0.047"	●	●	●	●	●	●	●	●	●	●								
	CNMG 644	CNMG190616	0.063"	●	●	●	●	●	●	●	●	●	●								

C

● : Line up

Reference pages

External toolholders → **B202** - Internal toolholders → **B294** -
 J series toolholders → **B376** TungCap → **B223** -, **F006** -

TurnLine - Insert

● : Continuous cutting
 ● : Light interrupted cutting
 * : Heavy interrupted cutting

NEGATIVE TYPE



Rhombic, 80°
with hole

	P	M	K	N	S	H
Steel	●●●●●●●●●●					
Stainless		●●●●●●●●●●				
Cast iron	●●		●●●●●●●●●●			
Non-ferrous				●●●●●●●●●●		
Superalloys					●●●●●	
Hard materials						●●●●●

Application	Chipbreaker	Designation		Corner radius	Coated							Coated cermet	Cermet	Uncoated				
		Inch	Metric		T9115	T9125	T9135	AH110	AH120	AH725	AH905	GH330	GT720	NS9530	TH10			
Finishing to medium cutting		27	CNMG 431 TN27	CNMG120404-27	0.016"	●	●											
			CNMG 432 TN27	CNMG120408-27	0.031"	●	●	●		●			●					
			CNMG 433 TN27	CNMG120412-27	0.047"		●											
Medium cutting		28	CNGP 430-28	CNGP120401-28	0.004"				●	●								
			CNGP 430.5-28	CNGP120402-28	0.008"				●	●								
			CNGP 431-28	CNGP120404-28	0.016"				●	●								
			CNGP 432-28	CNGP120408-28	0.031"				●	●								
			CNMG 431 TN28	CNMG120404-28	0.016"		●		●	●								
			CNMG 432 TN28	CNMG120408-28	0.031"		●		●	●								
			CNMG 433 TN28	CNMG120412-28	0.047"					●								
Medium cutting		33	CNMG 432 TN33	CNMG120408-33	0.031"				●			●						
			CNMG 434 TN33	CNMG120416-33	0.063"		●											
			CNMG 543 TN33	CNMG160612-33	0.047"		●											
			CNMG 643 TN33	CNMG190612-33	0.047"		●											
Medium cutting		37	CNMG 431 TN37	CNMG120404-37	0.016"	●							●					
			CNMG 432 TN37	CNMG120408-37	0.031"	●							●		●			
			CNMG 433 TN37	CNMG120412-37	0.047"	●												
Medium cutting		38	CNMG 431 TN38	CNMG120404-38	0.016"	●				●	●				●			
			CNMG 432 TN38	CNMG120408-38	0.031"	●				●	●					●		

● : Line up

Reference pages

External toolholders → **B208** -
 J series toolholders → **B376**

Internal toolholders → **B321** -
 TungCap → **B223** -, **F006** -



Insert

Negative

C



Insert

TurnLine - Insert

● : Continuous cutting
 ● : Light interrupted cutting
 * : Heavy interrupted cutting

NEGATIVE TYPE



Rhombic, 80°
with hole

P	Steel	●	*	●	*						●		●	●	●			
M	Stainless	●	●	●	*					●	●	●	●	●	●	●	●	
K	Cast iron					●	●	●	●	●	●	●	●	●	●	●	●	●
N	Non-ferrous																	●
S	Superalloys																	●
H	Hard materials																	

Negative

Application	Chipbreaker	Designation		Corner radius	Coated											Cermet	Uncoated				
		Inch	Metric		T6120	T6130	AH630	AH645	T515	T5105	T5115	T5125	AH725	AH8005	AH8015	AH905	GH110	NS9530	TH10	KS05F	
Medium cutting	SM	CNMG 331E-SM	CNMG090404E-SM	0.016"	●	●	●														
		CNMG 332E-SM	CNMG090408E-SM	0.031"	●	●	●														
		CNMG 333E-SM	CNMG090412E-SM	0.047"	●	●	●														
		CNMG 431 SM	CNMG120404-SM	0.016"	●	●	●	●					●								
		CNMG 432 SM	CNMG120408-SM	0.031"	●	●	●	●					●		●						
		CNMG 433 SM	CNMG120412-SM	0.047"	●	●	●	●					●								
	P	CNMG 431 CM	CNMG120404-CM	0.016"					●	●	●										
		CNMG 432 CM	CNMG120408-CM	0.031"					●	●	●	●									
		CNMG 433 CM	CNMG120412-CM	0.047"					●	●	●	●									
		CNMG 542 CM	CNMG160608-CM	0.031"						●	●	●									
CNMG 543 CM		CNMG160612-CM	0.047"						●	●	●										
Finishing to medium cutting	P	CNGG 431 R-P	CNGG120404R-P	0.016"											●	●		●			
		CNGG 431 L-P	CNGG120404L-P	0.016"											●	●		●			
		CNGG 432 R-P	CNGG120408R-P	0.031"											●	●		●			
		CNGG 432 L-P	CNGG120408L-P	0.031"											●	●		●			
	HRM	CNMG 431 HRM	CNMG120404-HRM	0.016"										●	●						
		CNMG 432 HRM	CNMG120408-HRM	0.031"										●	●						
		CNMG 433 HRM	CNMG120412-HRM	0.047"										●	●						
		CNMG 542 HRM	CNMG160608-HRM	0.031"										●	●						
		CNMG 543 HRM	CNMG160612-HRM	0.047"										●	●						
		CNMG 643 HRM	CNMG190612-HRM	0.047"										●	●						
Medium cutting	HMM	CNMG 431 HMM	CNMG120404-HMM	0.016"											●						
		CNMG 432 HMM	CNMG120408-HMM	0.031"											●					●	
		CNMG 433 HMM	CNMG120412-HMM	0.047"											●						
		CNMG 542 HMM	CNMG160608-HMM	0.031"											●						
		CNMG 543 HMM	CNMG160612-HMM	0.047"											●						
		CNMG 544 HMM	CNMG160616-HMM	0.063"											●						

● : Line up

Reference pages

External toolholders → B202 -
 J series toolholders → B376

Internal toolholders → B294 -
 TungCap → B223 -, F006 -

TurnLine - Insert

● : Continuous cutting
 ● : Light interrupted cutting
 ※ : Heavy interrupted cutting

NEGATIVE TYPE

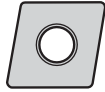

Rhombic, 80°
with hole

Material	T9105	T9115	T9125	T9135	T6120	T6130	AH630	AH645	AH110	AH120	GH330	GT720	NS9530	KS20
P Steel	●	●●	●●	●●	●	●	●	●	●	●	●	●	●	●
M Stainless					●	●	●	●	●	●	●			
K Cast iron	●●	●●	●●	●●					●	●	●	●	●	●
N Non-ferrous														●
S Superalloys									●	●				●
H Hard materials														

Application	Chipbreaker	Designation		Corner radius	Coated										Coated cermet	Cermet	Uncoated	
		Inch	Metric		T9105	T9115	T9125	T9135	T6120	T6130	AH630	AH645	AH110	AH120	GH330	GT720	NS9530	KS20
Medium cutting		SA	CNMG 431 SA	CNMG120404-SA	0.016"													
			CNMG 432 SA	CNMG120408-SA	0.031"							●						
			CNMG 433 SA	CNMG120412-SA	0.047"							●						
			CNMG 643 SA	CNMG190612-SA	0.047"							●						
			CNMG 644 SA	CNMG190616-SA	0.063"							●						
	S	CNMG 431 R-S	CNMG120404R-S	0.016"		●	●		●	●	●		●	●		●		
		CNMG 431 L-S	CNMG120404L-S	0.016"		●	●		●	●	●		●			●		
		CNMG 432 R-S	CNMG120408R-S	0.031"		●	●		●	●	●		●	●		●		
	CNMG 432 L-S	CNMG120408L-S	0.031"		●	●		●	●	●		●			●			
Medium to heavy cutting		TH	CNMG 432 TH	CNMG120408-TH	0.031"	●	●	●	●		●							
			CNMG 433 TH	CNMG120412-TH	0.047"	●	●	●	●		●							
			CNMG 434 TH	CNMG120416-TH	0.063"	●	●	●	●									
			CNMG 543 TH	CNMG160612-TH	0.047"	●	●	●	●		●							
			CNMG 544 TH	CNMG160616-TH	0.063"	●	●	●	●		●							
			CNMG 643 TH	CNMG190612-TH	0.047"	●	●	●	●		●							
			CNMG 644 TH	CNMG190616-TH	0.063"	●	●	●	●		●							
		THS	CNMG 432 THS	CNMG120408-THS	0.031"	●	●	●	●									
		CNMG 433 THS	CNMG120412-THS	0.047"	●	●	●	●										
		CNMG 434 THS	CNMG120416-THS	0.063"	●	●	●	●										
		CNMG 543 THS	CNMG160612-THS	0.047"	●	●	●	●										
		CNMG 544 THS	CNMG160616-THS	0.063"	●	●	●	●										
		CNMG 643 THS	CNMG190612-THS	0.047"		●	●	●										
		CNMG 644 THS	CNMG190616-THS	0.063"		●	●	●										
	CNMG 646 THS	CNMG190624-THS	0.094"		●	●	●											
	CNMG 866 THS	CNMG250924-THS	0.094"		●	●	●											

● : Line up

Reference pages

External toolholders → **B208** - Internal toolholders → **B321** -
 J series toolholders → **B376** TungCap → **B223** -, **F006** -



Insert

Negative

C



Insert

Negative

TurnLine - Insert

● : Continuous cutting
 ● : Light interrupted cutting
 * : Heavy interrupted cutting

NEGATIVE TYPE

**Rhombic, 80° with hole**

	P Steel	M Stainless	K Cast iron	N Non-ferrous	S Superalloys	H Hard materials												
P Steel	● ● ●	● ● ●	● ● ●	● ● ●	● ● ●	● ● ●	● ● ●	● ● ●	● ● ●	● ● ●	● ● ●	● ● ●	● ● ●	● ● ●	● ● ●	● ● ●	● ● ●	● ● ●
M Stainless	● ● ●	● ● ●	● ● ●	● ● ●	● ● ●	● ● ●	● ● ●	● ● ●	● ● ●	● ● ●	● ● ●	● ● ●	● ● ●	● ● ●	● ● ●	● ● ●	● ● ●	● ● ●
K Cast iron	● ● ●	● ● ●	● ● ●	● ● ●	● ● ●	● ● ●	● ● ●	● ● ●	● ● ●	● ● ●	● ● ●	● ● ●	● ● ●	● ● ●	● ● ●	● ● ●	● ● ●	● ● ●
N Non-ferrous	● ● ●	● ● ●	● ● ●	● ● ●	● ● ●	● ● ●	● ● ●	● ● ●	● ● ●	● ● ●	● ● ●	● ● ●	● ● ●	● ● ●	● ● ●	● ● ●	● ● ●	● ● ●
S Superalloys	● ● ●	● ● ●	● ● ●	● ● ●	● ● ●	● ● ●	● ● ●	● ● ●	● ● ●	● ● ●	● ● ●	● ● ●	● ● ●	● ● ●	● ● ●	● ● ●	● ● ●	● ● ●
H Hard materials	● ● ●	● ● ●	● ● ●	● ● ●	● ● ●	● ● ●	● ● ●	● ● ●	● ● ●	● ● ●	● ● ●	● ● ●	● ● ●	● ● ●	● ● ●	● ● ●	● ● ●	● ● ●

Application	Chipbreaker	Designation		Corner radius	Coated														
		Inch	Metric		T9115	T9125	T9135	T6130	AH630	AH645	T515	T5105	T5115	T5125					
Medium to heavy cutting (Single sided)		TRS	CNMM 432 TRS	CNMM120408-TRS	0.031"	● ● ●	● ● ●	● ● ●											
			CNMM 433 TRS	CNMM120412-TRS	0.047"	● ● ●	● ● ●	● ● ●											
			CNMM 543 TRS	CNMM160612-TRS	0.047"	● ● ●	● ● ●	● ● ●											
			CNMM 544 TRS	CNMM160616-TRS	0.063"	● ● ●	● ● ●	● ● ●											
			CNMM 644 TRS	CNMM190616-TRS	0.063"	● ● ●	● ● ●	● ● ●											
			CNMM 646 TRS	CNMM190624-TRS	0.094"	● ● ●	● ● ●	● ● ●											
			CNMM 866 TRS	CNMM250924-TRS	0.094"	● ● ●	● ● ●	● ● ●											
Heavy cutting (Single sided)		TU	CNMM 643 TU	CNMM190612-TU	0.047"		● ● ●	● ● ●											
			CNMM 644 TU	CNMM190616-TU	0.063"		● ● ●	● ● ●											
			CNMM 646 TU	CNMM190624-TU	0.094"	● ● ●	● ● ●	● ● ●											
			CNMM 866 TU	CNMM250924-TU	0.094"		● ● ●	● ● ●											
		TUS	CNMM 642 TUS	CNMM190608-TUS	0.031"	● ● ●	● ● ●												
			CNMM 643 TUS	CNMM190612-TUS	0.047"	● ● ●	● ● ●	● ● ●											
			CNMM 644 TUS	CNMM190616-TUS	0.063"	● ● ●	● ● ●	● ● ●											
			CNMM 646 TUS	CNMM190624-TUS	0.094"	● ● ●	● ● ●	● ● ●											
Medium to heavy cutting		SH	CNMG 432 SH	CNMG120408-SH	0.031"				● ● ●	● ● ●	● ● ●								
			CNMG 433 SH	CNMG120412-SH	0.047"				● ● ●	● ● ●	● ● ●								
			CNMG 434 SH	CNMG120416-SH	0.063"				● ● ●	● ● ●	● ● ●								
			CNMG 543 SH	CNMG160612-SH	0.047"				● ● ●	● ● ●	● ● ●								
			CNMG 544 SH	CNMG160616-SH	0.063"				● ● ●	● ● ●	● ● ●								
			CNMG 643 SH	CNMG190612-SH	0.047"				● ● ●	● ● ●	● ● ●								
			CNMG 644 SH	CNMG190616-SH	0.063"				● ● ●	● ● ●	● ● ●								
	CH	CNMG 431 CH	CNMG120404-CH	0.016"							● ● ●	● ● ●	● ● ●						
		CNMG 432 CH	CNMG120408-CH	0.031"							● ● ●	● ● ●	● ● ●	● ● ●					
		CNMG 433 CH	CNMG120412-CH	0.047"							● ● ●	● ● ●	● ● ●	● ● ●					
		CNMG 543 CH	CNMG160612-CH	0.047"							● ● ●	● ● ●	● ● ●	● ● ●					
		CNMG 544 CH	CNMG160616-CH	0.063"							● ● ●	● ● ●	● ● ●	● ● ●					
		CNMG 643 CH	CNMG190612-CH	0.047"							● ● ●	● ● ●	● ● ●	● ● ●					
	CNMG 644 CH	CNMG190616-CH	0.063"							● ● ●	● ● ●	● ● ●	● ● ●						

Reference pages

External toolholders → B208 - Internal toolholders → B321 -
 J series toolholders → B376 TungCap → B223 -, F006 -

● : Line up

TurnLine - Insert

● : Continuous cutting
 ● : Light interrupted cutting
 * : Heavy interrupted cutting

NEGATIVE TYPE

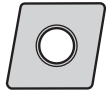

Rhombic, 80°
with hole

Material	Steel	Stainless	Cast iron	Non-ferrous	Superalloys	Hard materials
P	●					●
M		●				●
K	●●●●	●	●			●
N				●		
S						
H						●

Application	Chipbreaker	Designation		Corner radius	Coated					Cermet	Uncoated	Ceramics			
		Inch	Metric		T9105	T515	T5105	T5115	T5125	NS520	TH10	FX105	LX21	LX11	
Finishing to medium cutting	-	CNMA 431	CNMA120404	0.016"											
		CNMA 432	CNMA120408	0.031"	●	●	●	●	●	●	●	●			
		CNMA 433	CNMA120412	0.047"	●	●	●	●	●	●	●	●			
		CNMA 434	CNMA120416	0.063"	●		●	●	●		●	●			
		CNMA 542	CNMA160608	0.031"			●	●	●						
		CNMA 543	CNMA160612	0.047"		●	●	●	●						
		CNMA 544	CNMA160616	0.063"		●	●	●	●						
		CNMA 643	CNMA190612	0.047"		●	●	●	●						
		CNMA 644	CNMA190616	0.063"		●	●	●	●						
	Wiper	CNMA 432 W	CNMA120408W	0.031"									●		
		CNMA 433 W	CNMA120412W	0.047"									●		
		CNMA 434 W	CNMA120416W	0.063"									●		
	-	CNGA 431	CNGA120404	0.016"										●	●
		CNGA 432	CNGA120408	0.031"						●			●	●	●
		CNGA 433	CNGA120412	0.047"									●	●	●
CNGA 434		CNGA120416	0.063"									●	●		
CNGA 435		CNGA120420	0.078"										●		

● : Line up



Insert

Negative

C

Reference pages

External toolholders → B208 - Internal toolholders → B321 -
 TungCap → B223 -, F006 -



Insert

Negative

C

TurnLine - Insert

● : Continuous cutting
 ●c : Light interrupted cutting
 * : Heavy interrupted cutting

NEGATIVE TYPE



Rhombic, 80°
without hole

	P	M	K	N	S	H																		
Steel	●																							
Stainless		●																						
Cast iron			●c																					
Non-ferrous				●																				
Superalloys					●																			
Hard materials						●																		

Application	Chipbreaker	Designation		Corner radius	Ceramics																				
		Inch	Metric																						
					FX105	LX21	LX11	CX710																	
-		CNGD 453	CNGD120712	0.047"	●																				
		CNGD 454	CNGD120716	0.063"	●																				
-		CNMN 432	CNMN120408	0.031"	●																				
		CNMN 433	CNMN120412	0.047"	●																				
Finishing to medium cutting		CNGN 431	CNGN120404	0.016"			●																		
		CNGN 432	CNGN120408	0.031"	●		●																		
		CNGN 433	CNGN120412	0.047"	●		●																		
		CNGN 434	CNGN120416	0.063"	●	●	●																		
		CNGN 435	CNGN120420	0.078"	●																				
		CNGN 452	CNGN120708	0.031"	●		●																		
		CNGN 453	CNGN120712	0.047"	●		●																		
		CNGN 454	CNGN120716	0.063"	●		●																		
		CNGN 455	CNGN120720	0.078"			●																		

● : Line up

Reference pages

CNGD... : External toolholders → **B271**

CNMN..., CNGN... : External toolholders → **B246**, Internal toolholders → **B341**





TurnLine - Insert

● : Continuous cutting
 ● : Light interrupted cutting
 ✱ : Heavy interrupted cutting

NEGATIVE TYPE

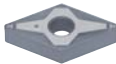
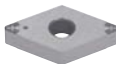

P	Steel	●	●	●	●	✱	●	●		●	●	●	●	●	●	●
M	Stainless	●					●	●		●	●	●	●	●	●	●
K	Cast iron	●	●	●	●		●	●		●	●	●	●	●	●	●
N	Non-ferrous															●
S	Superalloys						●	●								
H	Hard materials															

Application	Chipbreaker	Designation		Corner radius	Coated						Coated cermet		Cermet		Uncoated			
		Inch	Metric		T9105	T9115	T9125	T9135	AH120	GH110	GT9530	GT720	NS9530	NS520	TH10			
Precision finishing		TF	DNMG 431 TF	DNMG150404-TF	0.016"													
			DNMG 432 TF	DNMG150408-TF	0.031"													
		01	DNGG 330.5-01	DNGG110402-01	0.008"													
			DNGG 331-01	DNGG110404-01	0.016"													
			DNGG 332-01	DNGG110408-01	0.031"							●						
			DNGG 430.5-01	DNGG150402-01	0.008"													
Finishing		TSF	DNMG 331E-TSF	DNMG110404E-TSF	0.016"		●	●										
			DNGG 332E-TSF	DNMG110408E-TSF	0.031"		●	●										
			DNGG 333E-TSF	DNMG110412E-TSF	0.047"		●	●										
			DNMG 431 TSF	DNMG150404-TSF	0.016"	●	●	●	●	●								
			DNMG 432 TSF	DNMG150408-TSF	0.031"	●	●	●	●	●								
			DNMG 433 TSF	DNMG150412-TSF	0.047"	●	●	●	●	●								
			DNMG 441 TSF	DNMG150604-TSF	0.016"		●	●										
			DNMG 442 TSF	DNMG150608-TSF	0.031"	●	●	●	●									
			DNMG 443 TSF	DNMG150612-TSF	0.047"	●	●	●	●									
Finishing (Wiper)		FW	DNMG 331E-FW	DNMG110404E-FW	0.016"		●											
			DNMG 332E-FW	DNMG110408E-FW	0.031"		●											
			DNMG 431 FW	DNMG150404-FW	0.016"		●											
			DNMG 432 FW	DNMG150408-FW	0.031"		●											
			DNMG 441 FW	DNMG150604-FW	0.016"		●											
			DNMG 442 FW	DNMG150608-FW	0.031"		●											
Finishing		ZF	DNMG331E-ZF	DNMG110404E-ZF	0.016"		●	●										
			DNMG 431 ZF	DNMG150404-ZF	0.016"		●	●	●									
			DNMG 432 ZF	DNMG150408-ZF	0.031"		●	●	●									
			DNMG 433 ZF	DNMG150412-ZF	0.047"		●	●	●									
			DNMG 441 ZF	DNMG150604-ZF	0.016"		●	●										
			DNMG 442 ZF	DNMG150608-ZF	0.031"		●	●	●									
	DNMG 443 ZF	DNMG150612-ZF	0.047"		●	●												

Reference pages

External toolholders → B204 -	Internal toolholders → B296 -
J series toolholders → B376	TungCap → B223 -, F008 -

● : Line up



Insert

Negative

D



Insert

Negative

D

TurnLine - Insert

● : Continuous cutting
 ● : Light interrupted cutting
 * : Heavy interrupted cutting

NEGATIVE TYPE



Material	Steel	Stainless	Cast iron	Non-ferrous	Superalloys	Hard materials	T9115	T6120	T6130	AH630	T5105	T5115	AH8005	AH8015	GH330	NS9530	TH10	
P	●●	●	●	●	●	●	●	●	●	●	●	●	●	●	●	●	●	●
M	●	●●	●	●	●	●	●	●	●	●	●	●	●	●	●	●	●	●
K	●●	●	●	●	●	●	●	●	●	●	●	●	●	●	●	●	●	●
N	●	●	●	●	●	●	●	●	●	●	●	●	●	●	●	●	●	●
S	●	●	●	●	●	●	●	●	●	●	●	●	●	●	●	●	●	●
H	●	●	●	●	●	●	●	●	●	●	●	●	●	●	●	●	●	●

Application	Chipbreaker	Designation		Corner radius	Coated								Cermet	Uncoated						
		Inch	Metric		T9115	T6120	T6130	AH630	T5105	T5115	AH8005	AH8015	GH330	NS9530	TH10					
Finishing		11	DNMG 331 TN11	DNMG110404-11	0.016"															
			DNMG 332 TN11	DNMG110408-11	0.031"															
			DNMG 431 TN11	DNMG150404-11	0.016"															
			DNMG 432 TN11	DNMG150408-11	0.031"	●														
Finishing of mild steels		17	DNMG 431 TN17	DNMG150404-17	0.016"															
			DNMG 432 TN17	DNMG150408-17	0.031"															
Finishing		SF	DNMG 431 SF	DNMG150404-SF	0.016"	●	●	●												
			DNMG 432 SF	DNMG150408-SF	0.031"	●	●	●												
			DNMG 441 SF	DNMG150604-SF	0.016"	●	●	●												
			DNMG 442 SF	DNMG150608-SF	0.031"	●	●	●												
		CF	DNMG 431 CF	DNMG150404-CF	0.016"				●	●										
		DNMG 432 CF	DNMG150408-CF	0.031"				●	●											
		DNMG 433 CF	DNMG150412-CF	0.047"				●	●											
		DNMG 441 CF	DNMG150604-CF	0.016"				●	●											
	HRF	DNMG 431 HRF	DNMG150404-HRF	0.016"									●	●						
	DNMG 432 HRF	DNMG150408-HRF	0.031"										●	●						
	DNMG 441 HRF	DNMG150604-HRF	0.016"										●	●						
	DNMG 442 HRF	DNMG150608-HRF	0.031"										●	●						

● : Line up

Reference pages

External toolholders → **B204 -**
 J series toolholders → **B376**

Internal toolholders → **B296 -**
 TungCap → **B223 -, F008 -**

TurnLine - Insert

- : Continuous cutting
- ◐ : Light interrupted cutting
- * : Heavy interrupted cutting

NEGATIVE TYPE



Material	P Steel	M Stainless	K Cast iron	N Non-ferrous	S Superalloys	H Hard materials
Coated	● ● ● ● *					
Coated cermet	● ●		● ●			
Cermet			● ● ● ●			

Application	Chipbreaker	Designation		Corner radius	Coated				Coated cermet	Cermet		
		Inch	Metric		T9105	T9115	T9125	T9135	GT9530	NS9530	NS520	
Finishing		TS	DNMG 332 TS	DNMG110408-TS	0.031"	●						
			DNMG 431 TS	DNMG150404-TS	0.016"		● ● ●		●	● ●		
			DNMG 432 TS	DNMG150408-TS	0.031"	● ● ● ●			●	● ●		
			DNMG 433 TS	DNMG150412-TS	0.047"	● ● ● ●						
			DNMG 441 TS	DNMG150604-TS	0.016"				●	● ●		
			DNMG 442 TS	DNMG150608-TS	0.031"		● ●		●	● ●		
			DNMG 443 TS	DNMG150612-TS	0.047"		● ●					
Finishing to medium cutting (Wiper)		SW	DNMG 332E-SW	DNMG110408E-SW	0.031"	●						
			DNMG 333E-SW	DNMG110412E-SW	0.047"	●						
			DNMG 432 SW	DNMG150408-SW	0.031"		●					
			DNMG 433 SW	DNMG150412-SW	0.047"		●					
			DNMG 442 SW	DNMG150608-SW	0.031"		●					
			DNMG 443 SW	DNMG150612-SW	0.047"		●					
High feed, small depth of cut		AS	DNMG 431 AS	DNMG150404-AS	0.016"		●	●		●		
			DNMG 432 AS	DNMG150408-AS	0.031"		● ● ●			●		
			DNMG 433 AS	DNMG150412-AS	0.047"	● ● ● ●						
			DNMG 441 AS	DNMG150604-AS	0.016"		●					
			DNMG 442 AS	DNMG150608-AS	0.031"		● ●					
			DNMG 443 AS	DNMG150612-AS	0.047"		●					
Boring (Double sided)		CB	DNMG 331 CB	DNMG110404-CB	0.016"		●		●	●		
			DNMG 332 CB	DNMG110408-CB	0.031"		●		●	●		
Finishing		NS	DNMG 431 NS	DNMG150404-NS	0.016"			●		●		
			DNMG 432 NS	DNMG150408-NS	0.031"	● ● ●				●		

● : Line up

Reference pages

External toolholders → **B204** -
J series toolholders → **B376**

Internal toolholders → **B296** -
TungCap → **B223, F008** -



Insert

Negative

D



Insert

Negative

TurnLine - Insert

● : Continuous cutting
 ● : Light interrupted cutting
 * : Heavy interrupted cutting

NEGATIVE TYPE



Rhombic, 55° with hole

	P	M	K	N	S	H															
Steel	●	●●	●●	●●	●●	●●	●	●	●	●	●	●	●	●	●	●	●	●	●	●	●
Stainless	●	●	●	●	●	●	●	●	●	●	●	●	●	●	●	●	●	●	●	●	●
Cast iron	●●	●●	●●	●●	●●	●●	●	●	●	●	●	●	●	●	●	●	●	●	●	●	●
Non-ferrous	●	●	●	●	●	●	●	●	●	●	●	●	●	●	●	●	●	●	●	●	●
Superalloys	●	●	●	●	●	●	●	●	●	●	●	●	●	●	●	●	●	●	●	●	●
Hard materials	●	●	●	●	●	●	●	●	●	●	●	●	●	●	●	●	●	●	●	●	●

Application	Chipbreaker	Designation		Corner radius	Coated										Coated cermet	Cermet	Uncoated						
		Inch	Metric		T9105	T9115	T9125	T9135	T6120	T6130	AH630	AH645	AH110	AH120	GH330	GT9530	NS9530	KS20					
Finishing		SS	DNMG 331E SS	DNMG110404E-SS	0.016"																		
			DNMG 332E SS	DNMG110408E-SS	0.031"																		
			DNMG 431 SS	DNMG150404-SS	0.016"					●	●	●	●		●	●							
			DNMG 432 SS	DNMG150408-SS	0.031"					●	●	●	●		●	●							●
			DNMG 433 SS	DNMG150412-SS	0.047"					●	●	●	●		●								
			DNMG 441 SS	DNMG150604-SS	0.016"					●	●	●	●			●							
			DNMG 442 SS	DNMG150608-SS	0.031"					●	●	●	●			●							
			DNMG 443 SS	DNMG150612-SS	0.047"					●	●	●	●			●							
Medium cutting		TM	DNMG 331E TM	DNMG110404E-TM	0.016"		●	●															
			DNMG 332E TM	DNMG110408E-TM	0.031"		●	●															
			DNMG 333E TM	DNMG110412E-TM	0.047"		●	●															
			DNMG 331 TM	DNMG110404-TM	0.016"		●	●	●														
			DNMG 332 TM	DNMG110408-TM	0.031"		●	●	●														
			DNMG 431 TM	DNMG150404-TM	0.016"	●	●	●	●						●	●							
			DNMG 432 TM	DNMG150408-TM	0.031"	●	●	●	●						●	●							
			DNMG 433 TM	DNMG150412-TM	0.047"	●	●	●	●						●	●							
			DNMG 434 TM	DNMG150416-TM	0.063"		●	●															
			DNMG 441 TM	DNMG150604-TM	0.016"	●	●	●	●							●							
			DNMG 442 TM	DNMG150608-TM	0.031"	●	●	●	●							●							
			DNMG 443 TM	DNMG150612-TM	0.047"	●	●	●	●							●							
			DNMG 444 TM	DNMG150616-TM	0.063"	●	●	●	●														
Finishing to medium cutting		AM	DNMG 432 AM	DNMG150408-AM	0.031"		●	●															
			DNMG 433 AM	DNMG150412-AM	0.047"		●	●															
			DNMG 434 AM	DNMG150416-AM	0.063"		●	●															
			DNMG 442 AM	DNMG150608-AM	0.031"		●	●															
			DNMG 443 AM	DNMG150612-AM	0.047"		●	●															
			DNMG 444 AM	DNMG150616-AM	0.063"		●	●															
			Finishing to medium cutting		NM	DNMG 432 NM	DNMG150408-NM	0.031"		●	●	●					●			●			
DNMG 433 NM	DNMG150412-NM	0.047"					●	●	●														
DNMG 442 NM	DNMG150608-NM	0.031"														●			●				

● : Line up

Reference pages

External toolholders → B204 -
 J series toolholders → B376

Internal toolholders → B296 -
 TungCap → B223, F008 -

TurnLine - Insert

● : Continuous cutting
 ● : Light interrupted cutting
 * : Heavy interrupted cutting

NEGATIVE TYPE



	P	M	K	N	S	H
Steel	●●●●*					
Stainless		●●●●				
Cast iron	●●●●		●●●●*			
Non-ferrous				●●●●		
Superalloys					●●●●	
Hard materials						●●●●

Application	Chipbreaker	Designation		Corner radius	Coated										Coated cermet	Cermet		Uncoated	
		Inch	Metric		T9105	T9115	T9125	T9135	T515	T5105	T5115	T5125	AH110	AH120	GT9530	NS9530	NS520	TH10	
Finishing to medium cutting		TQ	DNMG 431 TQ	DNMG150404-TQ	0.016"	●●●●*													
			DNMG 432 TQ	DNMG150408-TQ	0.031"									●		●			
		ZM	DNMG 332E-ZM	DNMG110408E-ZM	0.031"	●●													
			DNMG 432 ZM	DNMG150408-ZM	0.031"	●●●●								●		●			
			DNMG 433 ZM	DNMG150412-ZM	0.047"	●●●●													
		DNMG 442 ZM	DNMG150608-ZM	0.031"	●●●●														
Medium cutting		DM	DNMG 432 DM	DNMG150408-DM	0.031"	●●●●													
			DNMG 433 DM	DNMG150412-DM	0.047"	●●●●													
			DNMG 441 DM	DNMG150604-DM	0.016"	●													
			DNMG 442 DM	DNMG150608-DM	0.031"	●●●●													
			DNMG 443 DM	DNMG150612-DM	0.047"	●●●●													
			DNMG 444 DM	DNMG150616-DM	0.063"	●													
		All-round		DNMG 331	DNMG110404	0.016"	●●					●●●●			●		●		
				DNMG 332	DNMG110408	0.031"	●●●●					●●●●			●		●		
				DNMG 431	DNMG150404	0.016"	●●●●					●●●●	●●		●		●●		●
				DNMG 432	DNMG150408	0.031"	●●●●					●●●●	●●		●		●●		●
	DNMG 433		DNMG150412	0.047"	●●●●					●●●●	●●				●●		●		
	DNMG 434		DNMG150416	0.063"	●●					●●●●									
	DNMG 441		DNMG150604	0.016"	●●					●●●●							●		
	DNMG 442		DNMG150608	0.031"	●●●●					●●●●	●●						●		
	DNMG 443		DNMG150612	0.047"	●●●●					●●●●	●●						●		
Finishing to medium cutting		27	DNMG 431 27	DNMG150404-27	0.016"		●									●			
			DNMG 432 27	DNMG150408-27	0.031"		●●									●			
			DNMG 433 27	DNMG150412-27	0.047"		●												

● : Line up

Reference pages

External toolholders → **B204** -
 J series toolholders → **B376**

Internal toolholders → **B296** -
 TungCap → **B223, F008** -



Insert

Negative

D



Insert

Negative

TurnLine - Insert

● : Continuous cutting
● : Light interrupted cutting
* : Heavy interrupted cutting

NEGATIVE TYPE



P	Steel	●	●	●	*	●	*	●	●	●	●	●	●	●	●	●	●	●	●	●
M	Stainless	●	●	●	●	*	●	●	●	●	●	●	●	●	●	●	●	●	●	●
K	Cast iron	●	●	●	●	●	●	●	●	●	●	●	●	●	●	●	●	●	●	●
N	Non-ferrous	●	●	●	●	●	●	●	●	●	●	●	●	●	●	●	●	●	●	●
S	Superalloys	●	●	●	●	●	●	●	●	●	●	●	●	●	●	●	●	●	●	●
H	Hard materials	●	●	●	●	●	●	●	●	●	●	●	●	●	●	●	●	●	●	●

Application	Chipbreaker	Designation		Corner radius	Coated							Coated cermet	Cermet	Uncoated									
		Inch	Metric		T9115	T6120	T6130	AH630	AH645	AH110	AH120	GH330	GT9530	NS9530	TH10								
Medium cutting		28	DNMG 431 TN28	DNMG150404-28	0.016"																		
			DNMG 432 TN28	DNMG150408-28	0.031"					●	●												
		33	DNMG 431 33	DNMG150404-33	0.016"						●												
			DNMG 432 33	DNMG150408-33	0.031"						●									●			
		37	DNMG 431 37	DNMG150404-37	0.016"									●									
			DNMG 432 37	DNMG150408-37	0.031"							●			●								
		38	DNMG 433 38	DNMG150412-38	0.047"	●																	
		Parallel	DNGG 431 R	DNGG150404R	0.016"								●		●								
			DNGG 431 L	DNGG150404L	0.016"								●		●								
			DNGG 432 R	DNGG150408R	0.031"										●								
			DNGG 432 L	DNGG150408L	0.031"										●								
		SM	DNMG 331E SM	DNMG110404E-SM	0.016"	●	●	●															
		DNMG 332E SM	DNMG110408E-SM	0.031"	●	●	●																
		DNMG 431 SM	DNMG150404-SM	0.016"	●	●	●	●															
		DNMG 432 SM	DNMG150408-SM	0.031"	●	●	●	●															
		DNMG 433 SM	DNMG150412-SM	0.047"	●	●	●	●															
		DNMG 441 SM	DNMG150604-SM	0.016"	●	●	●	●															
		DNMG 442 SM	DNMG150608-SM	0.031"	●	●	●	●															
		DNMG 443 SM	DNMG150612-SM	0.047"	●	●	●	●															

● : Line up

Reference pages

External toolholders → B204 -
J series toolholders → B376

Internal toolholders → B296 -
TungCap → B223, F008 -

TurnLine - Insert

● : Continuous cutting
 ● : Light interrupted cutting
 * : Heavy interrupted cutting

NEGATIVE TYPE



Material	Steel	Stainless	Cast iron	Non-ferrous	Superalloys	Hard materials
P	●					
M		●				
K			●			
N				●		
S					●	
H						●

Application	Chipbreaker	Designation		Corner radius	Coated													Cermet	Un-coated						
		Inch	Metric		T9125	T9135	T6130	AH630	AH645	T515	T5105	T5115	T5125	AH110	AH120	AH8005	AH8015	AH905	GH110	GH330	NS9530	TH10			
Medium cutting		CM	DNMG 431 CM	DNMG150404-CM	0.016"																				
			DNMG 432 CM	DNMG150408-CM	0.031"						●	●	●	●											
			DNMG 433 CM	DNMG150412-CM	0.047"						●	●	●	●											
			DNMG 441 CM	DNMG150604-CM	0.016"							●	●	●											
			DNMG 442 CM	DNMG150608-CM	0.031"								●	●	●										
			DNMG 443 CM	DNMG150612-CM	0.047"								●	●	●										
		P	DNGG 430.5 FRP	DNGG150402R-P	0.008"														●					●	
			DNGG 430.5 FLP	DNGG150402L-P	0.008"															●				●	
			DNGG 431 FRP	DNGG150404R-P	0.016"															●				●	
			DNGG 431 FLP	DNGG150404L-P	0.016"															●				●	
			DNGG 432 FRP	DNGG150408R-P	0.031"																			●	
			DNGG 432 FLP	DNGG150408L-P	0.031"																			●	
Finishing to medium cutting		HRM	DNMG 431 HRM	DNMG150404-HRM	0.016"													●	●						
			DNMG 432 HRM	DNMG150408-HRM	0.031"														●	●					
			DNMG 433 HRM	DNMG150412-HRM	0.047"															●	●				
			DNMG 441 HRM	DNMG150604-HRM	0.016"															●	●				
			DNMG 442 HRM	DNMG150608-HRM	0.031"															●	●				
			DNMG 443 HRM	DNMG150612-HRM	0.047"															●	●				
Medium cutting		HMM	DNMG 431 HMM	DNMG150404-HMM	0.016"														●						
			DNMG 432 HMM	DNMG150408-HMM	0.031"															●					
			DNMG 433 HMM	DNMG150412-HMM	0.047"																●				
		SA	DNMG 431 SA	DNMG150404-SA	0.016"											●	●								
			DNMG 432 SA	DNMG150408-SA	0.031"											●	●								
			DNMG 441 SA	DNMG150604-SA	0.016"												●								
			DNMG 442 SA	DNMG150608-SA	0.031"												●								
		S	DNMG 431 R-S	DNMG150404R-S	0.016"	●	●	●	●	●											●	●			
			DNMG 431 L-S	DNMG150404L-S	0.016"	●	●	●	●	●												●	●		
			DNMG 432 R-S	DNMG150408R-S	0.031"	●	●	●	●	●												●	●		
			DNMG 432 L-S	DNMG150408L-S	0.031"	●	●	●	●	●													●	●	
		DNMG 441 R-S	DNMG150604R-S	0.016"	●	●	●	●	●																
		DNMG 441 L-S	DNMG150604L-S	0.016"	●	●	●	●	●																
		DNMG 442 R-S	DNMG150608R-S	0.031"	●	●	●	●	●												●				
		DNMG 442 L-S	DNMG150608L-S	0.031"	●	●	●	●	●																

Reference pages

External toolholders → B210 -
 J series toolholders → B376

Internal toolholders → B324 -
 TungCap → B223, F008 -

● : Line up



Insert

Negative

D



Insert

Negative

TurnLine - Insert

● : Continuous cutting
◐ : Light interrupted cutting
✱ : Heavy interrupted cutting

NEGATIVE TYPE

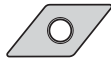

Rhombic, 55° with hole

P	Steel	●	●	●	✱	✱	●	●	●	●	●	●	●	●	●	●	●	●	●	●
M	Stainless	●	●	●	●	●	●	●	●	●	●	●	●	●	●	●	●	●	●	●
K	Cast iron	●	●	●	●	●	●	●	●	●	●	●	●	●	●	●	●	●	●	●
N	Non-ferrous	●	●	●	●	●	●	●	●	●	●	●	●	●	●	●	●	●	●	●
S	Superalloys	●	●	●	●	●	●	●	●	●	●	●	●	●	●	●	●	●	●	●
H	Hard materials	●	●	●	●	●	●	●	●	●	●	●	●	●	●	●	●	●	●	●

Application	Chipbreaker	Designation	Corner radius	Coated											Coated cermet	Cermet	Un-coated	Ceramics							
				Inch		Metric		T9115	T9125	T9135	T6130	AH630	AH645	T515	T5105	T5115	T5125	AH120	GT720	NS520	TH10	FX105	LX21	LX11	
				TH	THS	SH	CH	-	-	DNGA 431	DNGA 432	DNGA 433	DNGA 434	DNGA 442	DNGA 443	DNGA 444	DNGA 445								
Medium to heavy cutting		DNMG 432 TH	DNMG150408-TH	0.031"	●	●	●																		
		DNMG 433 TH	DNMG150412-TH	0.047"	●	●	●																		
		DNMG 434 TH	DNMG150416-TH	0.063"	●	●	●																		
		DNMG 442 TH	DNMG150608-TH	0.031"	●	●	●										●								
		DNMG 443 TH	DNMG150612-TH	0.047"	●	●	●										●								
		DNMG 444 TH	DNMG150616-TH	0.063"	●	●	●																		
		DNMG 432 THS	DNMG150408-THS	0.031"	●	●	●																		
		DNMG 433 THS	DNMG150412-THS	0.047"	●	●	●																		
		DNMG 434 THS	DNMG150416-THS	0.063"	●	●	●																		
		DNMG 442 THS	DNMG150608-THS	0.031"	●	●	●																		
		DNMG 443 THS	DNMG150612-THS	0.047"	●	●	●																		
		DNMG 444 THS	DNMG150616-THS	0.063"	●	●	●																		
		DNMG 432 SH	DNMG150408-SH	0.031"				●	●	●															
		DNMG 433 SH	DNMG150412-SH	0.047"				●	●	●															
		DNMG 434 SH	DNMG150416-SH	0.063"				●	●	●															
		DNMG 442 SH	DNMG150608-SH	0.031"				●	●	●															
		DNMG 443 SH	DNMG150612-SH	0.047"				●	●	●															
Finishing to medium cutting		DNMG 431 CH	DNMG150404-CH	0.016"									●	●	●										
		DNMG 432 CH	DNMG150408-CH	0.031"								●	●	●	●										
		DNMG 433 CH	DNMG150412-CH	0.047"								●	●	●	●										
		DNMG 441 CH	DNMG150604-CH	0.016"										●	●	●									
		DNMG 442 CH	DNMG150608-CH	0.031"										●	●	●									
		DNMG 443 CH	DNMG150612-CH	0.047"										●	●	●									
		DNMA 431	DNMA150404	0.016"										●	●	●		●							
		DNMA 432	DNMA150408	0.031"										●	●	●			●						
		DNMA 433	DNMA150412	0.047"											●	●	●								
		DNMA 441	DNMA150604	0.016"										●	●	●									
		DNMA 442	DNMA150608	0.031"										●	●	●									
		DNMA 443	DNMA150612	0.047"											●	●	●								
			DNGA 431	DNGA150404	0.016"														●		●		●	●	
			DNGA 432	DNGA150408	0.031"														●		●		●	●	
DNGA 433	DNGA150412		0.047"																●		●	●			
DNGA 434	DNGA150416		0.063"																	●		●	●		
DNGA 442	DNGA150608		0.031"																				●		
DNGA 443	DNGA150612		0.047"																				●		
DNGA 444	DNGA150616		0.063"																				●		
DNGA 445	DNGA150620		0.078"																				●		

● : Line up

TurnLine - Insert

● : Continuous cutting
 ●● : Light interrupted cutting
 * : Heavy interrupted cutting

NEGATIVE TYPE



P	Steel																					
M	Stainless																					
K	Cast iron	●●																				
N	Non-ferrous																					
S	Superalloys																					
H	Hard materials	●																				

Application	Chipbreaker	Designation		Corner radius	Ceramics																			
		Inch	Metric		FX105	LX11																		
Finishing to medium cutting		-	DNGD 452	DNGD150708	0.031"	●																		
			DNGD 453	DNGD150712	0.047"	●																		
			DNGD 454	DNGD150716	0.063"	●																		
			-	DNGN 431	DNGN150404	0.016"	●																	
			DNGN 432	DNGN150408	0.031"	●																		
			DNGN 433	DNGN150412	0.047"	●●																		
			DNGN 434	DNGN150416	0.063"	●																		
			DNGN 452	DNGN150708	0.031"	●																		
			DNGN 453	DNGN150712	0.047"	●																		
			DNGN 454	DNGN150716	0.063"	●																		
		-	DNMX 454	DNMX150716	0.063"	●																		

● : Line up

Insert
 Negative

D

Reference pages

- | | |
|---|-------------------------------|
| External toolholders → B210 - | Internal toolholders → B324 - |
| J series toolholders → B376 | TungCap → B223, F008 - |
| DNGD... : External toolholders → B271 - | |
| DNGN... : External toolholders → B247 | |



Insert

Negative

R

TurnLine - Insert

● : Continuous cutting
 ●● : Light interrupted cutting
 ●●● : Heavy interrupted cutting

NEGATIVE TYPE



Round, with hole

P Steel		●	●●	●●●	* ●	●●												
M Stainless						●●			●●									
K Cast iron		●●	●●			●●			●●									
N Non-ferrous									●									
S Superalloys							●●											
H Hard materials														●				

Application	Chipbreaker	Designation		Corner radius	Coated					Uncoated	Ceramics	
		Inch	Metric		T9105	T9115	T9125	T9135	AH120	TH10	LX11	
Heavy cutting		61	RNMG 32 TN61	RNMG090300-61	-		●	●				
			RNMG 43 TN61	RNMG120400-61	-	●	●	●	●	●		
			RNMG 54 TN61	RNMG150600-61	-		●	●				
			RNMG 64 TN61	RNMG190600-61	-		●	●	●			
			RNMG 86 TN61	RNMG250900-61	-		●	●				
Finishing to medium cutting		-	RNGA 43	RNGA120400	-						●	



Round, without hole

P Steel																		
M Stainless																		
K Cast iron		●●																
N Non-ferrous																		
S Superalloys						●	●											
H Hard materials						●												

Application	Chipbreaker	Designation		Corner radius	Ceramics				
		Inch	Metric		FX105	LX11	M101S	TW43	
Finishing to medium cutting		-	RNGN 43	RNGN120400	-	●	●	●	
			RNGN 45	RNGN120700	-	●	●	●	
			RNGN 43 T0420		-			●	
			RNGN 43 T6		-				●

● : Line up

Reference pages

RNMG..., RNGA... : External toolholders → B217 -

TurnLine - Insert

● : Continuous cutting
 ● : Light interrupted cutting
 * : Heavy interrupted cutting

NEGATIVE TYPE



Square, 90°
with hole

Material	Steel	Stainless	Cast iron	Non-ferrous	Superalloys	Hard materials
P	●●●*					
M		●●●				
K	●●		●●	●●●●●		
N				●●●●●		
S					●●●●●	
H						●●●●●

Application	Chipbreaker	Designation		Corner radius	Coated		Coated cermet		Cermet											
		Inch	Metric		T9115	T9125	GT9530	NS9530	NS520	X407										
Precision finishing		TF	SNMG 431 TF	SNMG120404-TF	0.016"					●										
			SNMG 432 TF	SNMG120408-TF	0.031"					●										
		01	SNGG 320.5-01	SNGG090302-01	0.008"					●	●									
			SNGG 321-01	SNGG090304-01	0.016"					●										
			SNGG 322-01	SNGG090308-01	0.031"					●	●									
			SNGG 430.5-01	SNGG120402-01	0.008"					●										
			SNGG 431-01	SNGG120404-01	0.016"					●										
			SNGG 432-01	SNGG120408-01	0.031"					●	●									
		B ~ D	SNGG 321 R-B	SNGG090304R-B	0.016"			●		●		●								
			SNGG 321 L-B	SNGG090304L-B	0.016"			●		●		●								
		SNGG 322 R-B	SNGG090308R-B	0.031"					●		●									
		SNGG 322 L-B	SNGG090308L-B	0.031"					●		●									
		SNGG 431 R-C	SNGG120404R-C	0.016"			●		●											
		SNGG 431 L-C	SNGG120404L-C	0.016"			●		●		●									
		SNGG 432 R-C	SNGG120408R-C	0.031"					●											
		SNGG 432 L-C	SNGG120408L-C	0.031"					●		●									
		SNGG 432 R-D	SNGG120408R-D	0.031"					●											
	SNGG 432 L-D	SNGG120408L-D	0.031"					●												
Finishing		TSF	SNMG 431 TSF	SNMG120404-TSF	0.016"	●	●	●		●										
			SNMG 432 TSF	SNMG120408-TSF	0.031"	●	●	●		●										
			SNMG 433 TSF	SNMG120412-TSF	0.047"	●	●													

● : Line up

Reference pages

External toolholders → B213 - Internal toolholders → B322 -



Insert

Negative

S



Insert

TurnLine - Insert

● : Continuous cutting
 ● : Light interrupted cutting
 * : Heavy interrupted cutting

NEGATIVE TYPE



Square, 90° with hole

P	Steel	●	●*	●*							●●							
M	Stainless	●	●	●			●	●			●●		●					
K	Cast iron						●	●			●●		●					
N	Non-ferrous												●					
S	Superalloys									●	●							
H	Hard materials																	

Negative

Application	Chipbreaker	Designation		Corner radius	Coated						Cermet	Uncoated						
		Inch	Metric		T6120	T6130	AH630	T5105	T5115	AH8005	AH8015	NS9530	TH10					
Finishing		11	SNMG 431 TN11	SNMG120404-11	0.016"								●					
			SNMG 432 TN11	SNMG120408-11	0.031"									●	●			
Finishing of mild steels		17	SNMG 432 TN17	SNMG120408-17	0.031"								●					
Finishing		SF	SNMG 431 SF	SNMG120404-SF	0.016"	●	●	●										
			SNMG 432 SF	SNMG120408-SF	0.031"	●	●	●										
Finishing		CF	SNMG 432 CF	SNMG120408-CF	0.031"				●	●								
			SNMG 433 CF	SNMG120412-CF	0.047"				●	●								
Finishing		HRF	SNMG 432 HRF	SNMG120408-HRF	0.031"												●	●
			SNMG 433 HRF	SNMG120412-HRF	0.047"													●

S

● : Line up

Reference pages
 External toolholders → B213 - Internal toolholders → B322 -

TurnLine - Insert

● : Continuous cutting
 ● : Light interrupted cutting
 * : Heavy interrupted cutting

NEGATIVE TYPE



Square, 90°
with hole

	P	M	K	N	S	H
Steel	●●●●●●●●	●●●●●●●●	●●●●●●●●	●●●●●●●●	●●●●●●●●	●●●●●●●●
Stainless	●●●●●●●●	●●●●●●●●	●●●●●●●●	●●●●●●●●	●●●●●●●●	●●●●●●●●
Cast iron	●●●●●●●●	●●●●●●●●	●●●●●●●●	●●●●●●●●	●●●●●●●●	●●●●●●●●
Non-ferrous	●●●●●●●●	●●●●●●●●	●●●●●●●●	●●●●●●●●	●●●●●●●●	●●●●●●●●
Superalloys	●●●●●●●●	●●●●●●●●	●●●●●●●●	●●●●●●●●	●●●●●●●●	●●●●●●●●
Hard materials	●●●●●●●●	●●●●●●●●	●●●●●●●●	●●●●●●●●	●●●●●●●●	●●●●●●●●

Application	Chipbreaker	Designation		Corner radius	Coated								Coated cermet	Cermet					
		Inch	Metric		T9105	T9115	T9125	T9135	T6120	T6130	AH630	AH645	AH120	GH330	GT9530	NS9530			
Finishing		TS	SNMG 431 TS	SNMG120404-TS	0.016"	●	●	●	●	●	●	●	●	●	●	●	●		
			SNMG 432 TS	SNMG120408-TS	0.031"	●	●	●	●	●	●	●	●	●	●	●	●	●	
			SNMG 433 TS	SNMG120412-TS	0.047"	●	●	●	●	●	●	●	●	●	●	●	●	●	
High feed, small depth of cut		AS	SNMG 431 AS	SNMG120404-AS	0.016"												●		
			SNMG 432 AS	SNMG120408-AS	0.031"	●	●											●	
Finishing		NS	SNMG 432 NS	SNMG120408-NS	0.031"	●	●												
		SS	SNMG 431 SS	SNMG120404-SS	0.016"					●	●	●	●	●					
			SNMG 432 SS	SNMG120408-SS	0.031"					●	●	●	●	●	●				
	SNMG 433 SS	SNMG120412-SS	0.047"					●	●	●	●	●	●						
Medium cutting		TM	SNMG 321 TM	SNMG090304-TM	0.016"	●	●	●											
			SNMG 322 TM	SNMG090308-TM	0.031"	●	●	●											
			SNMG 431 TM	SNMG120404-TM	0.016"	●	●						●						
			SNMG 432 TM	SNMG120408-TM	0.031"	●	●	●	●				●						
			SNMG 433 TM	SNMG120412-TM	0.047"	●	●	●	●				●						
			SNMG 434 TM	SNMG120416-TM	0.063"	●	●	●											
			SNMG 542 TM	SNMG150608-TM	0.031"	●													
			SNMG 543 TM	SNMG150612-TM	0.047"	●							●						
			SNMG 642 TM	SNMG190608-TM	0.031"	●							●						
			SNMG 643 TM	SNMG190612-TM	0.047"	●							●						

● : Line up

Reference pages

External toolholders → B213 - Internal toolholders → B322 -



Insert

Negative

S



Insert

TurnLine - Insert

● : Continuous cutting
●c : Light interrupted cutting
* : Heavy interrupted cutting

NEGATIVE TYPE



Square, 90°
with hole

P	Steel	●	●c	●c	●c	*	*							●	●c	●c	●c	●c	●c	●		
M	Stainless							c						●	●c					●		
K	Cast iron	●c	●c	●c				●c	●	c	*		●	●c	●c	●c	●c	●c	●c	●		
N	Non-ferrous																			●		
S	Superalloys													●	●c	c						
H	Hard materials																					

Negative

Application	Chipbreaker	Designation		Corner radius	Coated											Coated cermet	Cermet		Uncoated					
		Inch	Metric		T9105	T9115	T9125	T9135	T6130	T515	T5105	T5115	T5125	AH110	AH120	AH905	GT720	NS9530	NS520	TH10				
Finishing to medium cutting		ZM	SNMG 432 ZM	SNMG120408-ZM	0.031"	●	●c	●c	●c	*	*													
			SNMG 433 ZM	SNMG120412-ZM	0.047"	●	●	●																
Medium cutting		DM	SNMG 432 DM	SNMG120408-DM	0.031"	●	●																	
			SNMG 433 DM	SNMG120412-DM	0.047"	●	●	●																
Medium cutting		All-round	SNMG 321	SNMG090304	0.016"	●	●											●		●				
			SNMG 322	SNMG090308	0.031"	●	●	●											●		●			
			SNMG 431	SNMG120404	0.016"	●	●	●			●	●	●	●	●	●			●	●	●			
			SNMG 432	SNMG120408	0.031"	●	●	●	●		●	●	●	●	●	●	●	●	●	●	●	●		
			SNMG 433	SNMG120412	0.047"	●	●	●	●		●	●	●	●	●	●					●			
			SNMG 434	SNMG120416	0.063"	●	●	●	●			●	●	●										
			SNMG 435	SNMG120420	0.078"	●	●	●				●	●	●										
			SNMG 543	SNMG150612	0.047"	●	●	●	●	●	●													
			SNMG 544	SNMG150616	0.063"	●	●				●													
			SNMG 643	SNMG190612	0.047"	●	●	●	●	●	●	●	●	●		●								
			SNMG 644	SNMG190616	0.063"	●	●	●	●	●	●	●	●	●		●								
		Finishing to medium cutting		27	SNMG 432 TN27	SNMG120408-27	0.031"		●											●				
	SNMG 433 TN27			SNMG120412-27	0.047"		●																	

S

● : Line up

Reference pages

External toolholders → B213 - Internal toolholders → B322 -

TurnLine - Insert

● : Continuous cutting
 ● : Light interrupted cutting
 * : Heavy interrupted cutting

NEGATIVE TYPE



Square, 90°
with hole

	P	M	K	N	S	H
Steel	●●●*					
Stainless		●●●*				
Cast iron	●●		●●●*			
Non-ferrous				●●●*		
Superalloys					●●●*	
Hard materials						●●●*

Application	Chipbreaker	Designation		Corner radius	Coated														Cermet	Un-coated			
		Inch	Metric		T9115	T9125	T9135	T6120	T6130	AH630	AH645	T5105	T5115	T5125	AH725	AH8005	AH8015	GH110			GH330	NS9530	TH10
Medium cutting	37	SNMG 432 TN37	SNMG120408-37	0.031"	●	●													●				
	SM	SNMG 432 SM	SNMG120408-SM	0.031"				●	●	●	●			●									
		SNMG 433 SM	SNMG120412-SM	0.047"				●	●	●	●												
		SNMG 866 SM	SNMG250924-SM	0.094"	●	●	●		●														
	CM	SNMG 432 CM	SNMG120408-CM	0.031"								●	●	●									
		SNMG 433 CM	SNMG120412-CM	0.047"								●	●	●									
	P	SNGG 321 FRP	SNGG090304R-P	0.016"																	●		
		SNGG 321 FLP	SNGG090304L-P	0.016"																	●		
		SNGG 322 FRP	SNGG090308R-P	0.031"																	●		
		SNGG 322 FLP	SNGG090308L-P	0.031"																	●		
SNGG 431 FRP		SNGG120404R-P	0.016"																	●			
SNGG 431 FLP		SNGG120404L-P	0.016"																	●			
SNGG 432 FRP		SNGG120408R-P	0.031"																	●			
SNGG 432 FLP		SNGG120408L-P	0.031"																	●			
Finishing to medium cutting	HRM	SNMG 432 HRM	SNMG120408-HRM	0.031"																			
		SNMG 433 HRM	SNMG120412-HRM	0.047"																			
		SNMG 542 HRM	SNMG150608-HRM	0.031"																			
		SNMG 543 HRM	SNMG150612-HRM	0.047"																			
		SNMG 643 HRM	SNMG190612-HRM	0.047"																			
		SNMG 644 HRM	SNMG190616-HRM	0.063"																			

● : Line up

Reference pages

External toolholders → B213 - Internal toolholders → B322 -



Insert

Negative

S



Insert

TurnLine - Insert

● : Continuous cutting
 ● : Light interrupted cutting
 * : Heavy interrupted cutting

NEGATIVE TYPE



Material	T9105	T9115	T9125	T9135	T6120	T6130	AH630	AH645	AH120	AH905	GH330	NS9530	KS20
P Steel	●	●	●	●	●	●	●	●	●	●		●	
M Stainless					●	●	●	●	●	●			
K Cast iron	●	●	●						●	●		●	●
N Non-ferrous													●
S Superalloys									●	●			●
H Hard materials													

Negative

Application	Chipbreaker	Designation		Corner radius	Coated										Cermets	Uncoated	
		Inch	Metric		T9105	T9115	T9125	T9135	T6120	T6130	AH630	AH645	AH120	AH905	GH330	NS9530	KS20
Medium cutting		HMM	SNMG 432 HMM	SNMG120408-HMM	0.031"												
			SNMG 433 HMM	SNMG120412-HMM	0.047"							●					
Medium cutting		SA	SNMG 431 SA	SNMG120404-SA	0.016"					●	●						
			SNMG 432 SA	SNMG120408-SA	0.031"					●	●					●	
			SNMG 433 SA	SNMG120412-SA	0.047"					●	●						
			SNMG 643 SA	SNMG190612-SA	0.047"							●				●	
			SNMG 644 SA	SNMG190616-SA	0.063"							●					
Medium cutting		S	SNMG 431 R-S	SNMG120404R-S	0.016"		●	●		●	●				●		
			SNMG 431 L-S	SNMG120404L-S	0.016"		●	●		●	●				●		
			SNMG 432 R-S	SNMG120408R-S	0.031"			●	●		●	●			●		
			SNMG 432 L-S	SNMG120408L-S	0.031"			●	●		●	●			●		
Medium to heavy cutting		TH	SNMG 432 TH	SNMG120408-TH	0.031"	●	●	●	●		●						
			SNMG 433 TH	SNMG120412-TH	0.047"		●	●	●		●						
			SNMG 543 TH	SNMG150612-TH	0.047"	●	●	●			●						
			SNMG 544 TH	SNMG150616-TH	0.063"	●	●	●			●						
			SNMG 643 TH	SNMG190612-TH	0.047"	●	●	●	●		●						
			SNMG 644 TH	SNMG190616-TH	0.063"	●	●	●	●		●						
		THS	SNMG 432 THS	SNMG120408-THS	0.031"	●	●	●									
	SNMG 433 THS	SNMG120412-THS	0.047"	●	●	●											
	SNMG 543 THS	SNMG150612-THS	0.047"	●	●												
	SNMG 544 THS	SNMG150616-THS	0.063"	●	●												
	SNMG 642 THS	SNMG190608-THS	0.031"	●	●	●											
	SNMG 643 THS	SNMG190612-THS	0.047"	●	●	●											
	SNMG 644 THS	SNMG190616-THS	0.063"	●	●	●											
	SNMG 646 THS	SNMG190624-THS	0.094"	●	●	●											
	SNMG 854 THS	SNMG250716-THS	0.063"	●	●	●											
	SNMG 856 THS	SNMG250724-THS	0.094"	●	●	●											

● : Line up

Reference pages

External toolholders → B213 - Internal toolholders → B322 -

TurnLine - Insert

● : Continuous cutting
 ● : Light interrupted cutting
 * : Heavy interrupted cutting

NEGATIVE TYPE



Square, 90°
with hole

	P	M	K	N	S	H
Steel	●●●●●					
Stainless		●●●●●				
Cast iron	●●		●●●●●			
Non-ferrous				●●●●●		
Superalloys					●●●●●	
Hard materials						●●●●●

Application	Chipbreaker	Designation		Corner radius	Coated												
		Inch	Metric		T9115	T9125	T9135	T6130	AH630	AH645	T5105	T5115	T5125				
Medium to heavy cutting (Single sided)		TRS	SNMM 543 TRS	SNMM150612-TRS	0.047"	●	●	●									
			SNMM 544 TRS	SNMM150616-TRS	0.063"	●	●	●									
			SNMM 644 TRS	SNMM190616-TRS	0.063"	●	●	●									
			SNMM 646 TRS	SNMM190624-TRS	0.094"	●	●	●									
			SNMM 866 TRS	SNMM250924-TRS	0.094"	●	●	●									
Heavy cutting (Single sided)		TU	SNMM 644 TU	SNMM190616-TU	0.063"			●									
			SNMM 646 TU	SNMM190624-TU	0.094"		●	●									
			SNMM 856 TU	SNMM250724-TU	0.094"		●	●									
			SNMM 866 TU	SNMM250924-TU	0.094"	●	●										
Medium to heavy cutting		SH	SNMG 432 SH	SNMG120408-SH	0.031"				●	●	●						
			SNMG 433 SH	SNMG120412-SH	0.047"				●	●	●						
			SNMG 543 SH	SNMG150612-SH	0.047"				●	●	●						
			SNMG 544 SH	SNMG150616-SH	0.063"				●	●	●						
			SNMG 643 SH	SNMG190612-SH	0.047"				●	●	●						
			SNMG 644 SH	SNMG190616-SH	0.063"				●	●	●						
Medium to heavy cutting		CH	SNMG 432 CH	SNMG120408-CH	0.031"						●	●	●				
			SNMG 433 CH	SNMG120412-CH	0.047"						●	●	●				
			SNMG 434 CH	SNMG120416-CH	0.063"						●	●	●				

● : Line up

Reference pages

External toolholders → B213 - Internal toolholders → B322 -



Insert

Negative

S

• : Continuous cutting
 ◐ : Light interrupted cutting
 * : Heavy interrupted cutting



Insert

TurnLine - Insert

NEGATIVE TYPE



**Square, 90°
with hole**

Material	P	M	K	N	S	H	Coated	Coated cermet	Cermet	Uncoated	Ceramics
Steel	●						●	●	●		
Stainless		●					●	●	●	●	
Cast iron	●	●	●				●	●	●	●	●
Non-ferrous				●							
Superalloys					●						
Hard materials						●					

Negative

Application	Chipbreaker	Designation		Corner radius	Coated		Coated cermet	Cermet	Uncoated	Ceramics			
		Inch	Metric		T515	T5105	T5115	T5125	GT720	NS520	TH10	FX105	LX21
Finishing to medium cutting	-	SNMA 322	SNMA090308	0.031"	●	●	●						
		SNMA 323	SNMA090312	0.047"			●						
		SNMA 431	SNMA120404	0.016"	●	●	●	●					
		SNMA 432	SNMA120408	0.031"	●	●	●		●	●	●		
		SNMA 433	SNMA120412	0.047"	●	●	●		●	●	●		
		SNMA 434	SNMA120416	0.063"	●	●	●						
		SNMA 543	SNMA150612	0.047"	●	●	●						
		SNMA 643	SNMA190612	0.047"	●	●	●						
		-	SNGA 321	SNGA090304	0.016"					●			
		SNGA 431	SNGA120404	0.016"			●		●			●	
		SNGA 432	SNGA120408	0.031"				●	●		●	●	
		SNGA 433	SNGA120412	0.047"				●	●		●	●	
		SNGA 434	SNGA120416	0.063"							●	●	

● : Line up

S

Reference pages

External toolholders → **B213** - Internal toolholders → **B322** -

TurnLine - Insert

● : Continuous cutting
 ● : Light interrupted cutting
 * : Heavy interrupted cutting

NEGATIVE TYPE



Square, 90°
without hole

	P	M	K	N	S	H
Steel	●●	●●	●●	●●	●●	●●
Stainless	●●	●●	●●	●●	●●	●●
Cast iron	●●	●●	●●	●●	●●	●●
Non-ferrous	●●	●●	●●	●●	●●	●●
Superalloys	●●	●●	●●	●●	●●	●●
Hard materials	●●	●●	●●	●●	●●	●●

Application	Chipbreaker	Designation		Corner radius	Coated		Uncoated		Ceramics														
		Inch	Metric		AH120	TH10	FX105	LX21	LX11														
Finishing to medium cutting	-	SNGD 453	SNGD120712	0.047"																			
		SNGD 545	SNGD120716	0.063"						●													
	-	SNGN 322	SNGN090308	0.031"								●	●										
		SNGN 421	SNGN120304	0.016"										●									
		SNGN 423	SNGN120312	0.047"										●									
		SNGN 431	SNGN120404	0.016"										●									
		SNGN 432	SNGN120408	0.031"					●				●	●	●								
		SNGN 433	SNGN120412	0.047"									●	●	●								
		SNGN 434	SNGN120416	0.063"									●	●	●								
		SNGN 435	SNGN120420	0.078"									●	●									
		SNGN 436	SNGN120424	0.094"									●										
		SNGN 452	SNGN120708	0.031"											●								
		SNGN 453	SNGN120712	0.047"									●	●									
		SNGN 454	SNGN120716	0.063"									●	●									
		SNGN 455	SNGN120720	0.078"											●								
	-	SNMN 432	SNMN120408	0.031"					●														
		SNMN 433	SNMN-120412	0.047"	●																		
		*SNMN 434	SNMN120416	0.063"									●										
	-	**SNMN 432 TN	SNMN120408TN	0.031"									●										
		**SNMN 433 TN	SNMN120412TN	0.047"									●										
	**SNMN 434 TN	SNMN120416TN	0.063"									●											
	**SNMN 435 TN	SNMN120420TN	0.078"									●											
	**SNMN 436 TN	SNMN120424TN	0.094"									●											
	**SNMN 634 TN	SNMN190416TN	0.063"									●											
-	SNGX 545	SNGX120716										●											

* Chamfer hone 0.008" wide, -25° angle.
 ** Chamfer hone 0.005" wide, -25° angle.
 Note: Carbide grades have a radius hone.

● : Line up

Reference pages

SNGD... : External toolholders → B273

SNGN..., SNMN... : External toolholders → B256 -, Internal toolholders → B342 -



Insert

Negative

S

TurnLine - Insert

● : Continuous cutting
 ● : Light interrupted cutting
 * : Heavy interrupted cutting

NEGATIVE TYPE



Triangular, 60°
with hole

	P	M	K	N	S	H
Steel	●●●●●●●●	●●●●●●●●	●●●●●●●●	●●●●●●●●	●●●●●●●●	●●●●●●●●
Stainless	●●●●●●●●	●●●●●●●●	●●●●●●●●	●●●●●●●●	●●●●●●●●	●●●●●●●●
Cast iron	●●●●●●●●	●●●●●●●●	●●●●●●●●	●●●●●●●●	●●●●●●●●	●●●●●●●●
Non-ferrous	●●●●●●●●	●●●●●●●●	●●●●●●●●	●●●●●●●●	●●●●●●●●	●●●●●●●●
Superalloys	●●●●●●●●	●●●●●●●●	●●●●●●●●	●●●●●●●●	●●●●●●●●	●●●●●●●●
Hard materials	●●●●●●●●	●●●●●●●●	●●●●●●●●	●●●●●●●●	●●●●●●●●	●●●●●●●●

Application	Chipbreaker	Designation		Corner radius	Coated						Coated cermet	Cermet		Uncoated			
		Inch	Metric		T9105	T9115	T9125	T9135	AH120	SH725	GT9530	NS9530	X407	TH10			
Precision finishing		D	TNGG 431 R-D	TNGG220404R-D	0.016"	●	●	●	●	●	●	●	●	●	●	●	
			TNGG 431 L-D	TNGG220404L-D	0.016"								●				
			TNGG 432 R-D	TNGG220408R-D	0.031"								●	●			
			TNGG 432 L-D	TNGG220408L-D	0.031"								●				
Precision finishing		W	TNGG 331 R-W	TNGG160404R-W	0.016"							●			●		
			TNGG 331 L-W	TNGG160404L-W	0.016"							●			●		
			TNGG 332 R-W	TNGG160408R-W	0.031"							●					
			TNGG 332 L-W	TNGG160408L-W	0.031"							●					
Precision finishing (Sharp edge)		W	TNGG 330.5FR-W	TNGG160402FR-W	0.008"					●							
			TNGG 330.5FL-W	TNGG160402FL-W	0.008"					●							
			TNGG 331FR-W	TNGG160404FR-W	0.016"					●							
			TNGG 331FL-W	TNGG160404FL-W	0.016"					●							
			TNGG332FR-W	TNGG160408FR-W	0.031"					●							
			TNGG 332FL-W	TNGG160408FL-W	0.031"					●							
Finishing		TSF	TNMG 231E-TSF	TNMG110404E-TSF	0.016"	●	●				●		●				
			TNMG 232E-TSF	TNMG110408E-TSF	0.031"	●	●				●		●				
			TNMG 330.5 TSF	TNMG160402-TSF	0.008"					●		●					
			TNMG 331 TSF	TNMG160404-TSF	0.016"	●	●	●	●		●		●				
			TNMG 332 TSF	TNMG160408-TSF	0.031"	●	●	●	●	●	●		●				
			TNMG 333 TSF	TNMG160412-TSF	0.047"	●	●	●			●						
Finishing (Wiper)		FW	TNMG 231E-FW	TNMG110404E-FW	0.016"	●											
			TNMG 232E-FW	TNMG110408E-FW	0.031"	●											
			TNMG 332-FW	TNMG160404-FW	0.016"	●											
			TNMG 333-FW	TNMG160408-FW	0.031"	●											
Finishing		ZF	TNMG 331 ZF	TNMG160404-ZF	0.016"	●	●	●			●		●				
			TNMG 332 ZF	TNMG160408-ZF	0.031"	●	●	●			●		●				
			TNMG 333 ZF	TNMG160412-ZF	0.047"		●										

● : Line up

Reference pages

External toolholders → **B206** -
 J series toolholders → **B377** -

Internal toolholders → **B296** -



Insert

Negative



T



Insert

Negative

T

TurnLine - Insert

● : Continuous cutting
 ● : Light interrupted cutting
 * : Heavy interrupted cutting

NEGATIVE TYPE



**Triangular, 60°
with hole**

Material	Steel	Stainless	Cast iron	Non-ferrous	Superalloys	Hard materials	T9125	T6120	T6130	AH630	T5105	T5115	AH8005	AH8015	GH330	NS9530	TH10
P	●	●	●	●	●	●	●	●	●	●	●	●	●	●	●	●	●
M	●	●	●	●	●	●	●	●	●	●	●	●	●	●	●	●	●
K	●	●	●	●	●	●	●	●	●	●	●	●	●	●	●	●	●
N	●	●	●	●	●	●	●	●	●	●	●	●	●	●	●	●	●
S	●	●	●	●	●	●	●	●	●	●	●	●	●	●	●	●	●
H	●	●	●	●	●	●	●	●	●	●	●	●	●	●	●	●	●

Application	Chipbreaker	Designation		Corner radius	Coated							Cermet	Uncoated						
		Inch	Metric		T9125	T6120	T6130	AH630	T5105	T5115	AH8005	AH8015	GH330	NS9530	TH10				
Finishing		11	TNMG 221 TN11	TNMG110304-11	0.016"											●			
			TNMG 222 TN11	TNMG110308-11	0.031"												●		
			TNMG 330.5 TN11	TNMG160402-11	0.008"												●		
			TNMG 331 TN11	TNMG160404-11	0.016"										●		●		
			TNMG 332 TN11	TNMG160408-11	0.031"												●		
			TNMG 431 TN11	TNMG220404-11	0.016"												●		
			TNMG 432 TN11	TNMG220408-11	0.031"												●		
Finishing of mild steels		17	TNMG 331 TN17	TNMG160404-17	0.016"	●										●			
			TNMG 332 TN17	TNMG160408-17	0.031"	●											●		
Finishing		SF	TNMG 331 SF	TNMG160404-SF	0.016"		●	●	●										
			TNMG 332 SF	TNMG160408-SF	0.031"		●	●	●										
			TNMG 333 SF	TNMG160412-SF	0.047"		●	●	●										
Finishing		CF	TNMG 331 CF	TNMG160404-CF	0.016"					●	●								
			TNMG 332 CF	TNMG160408-CF	0.031"					●	●								
Finishing		HRF	TNMG 331 HRF	TNMG160404-HRF	0.016"								●	●					
			TNMG 332 HRF	TNMG160408-HRF	0.031"								●	●					

● : Line up

Reference pages

External toolholders → B211 -

Internal toolholders → B323 -

J series toolholders → B377 -

TurnLine - Insert

● : Continuous cutting
 ● : Light interrupted cutting
 * : Heavy interrupted cutting

NEGATIVE TYPE



Triangular, 60°
with hole

Material	Steel	Stainless	Cast iron	Non-ferrous	Superalloys	Hard materials
P	● ● ● ● *	● ● ● ● *	● ● ● ● *	● ● ● ● *	● ● ● ● *	● ● ● ● *
M	● ● ● ● *	● ● ● ● *	● ● ● ● *	● ● ● ● *	● ● ● ● *	● ● ● ● *
K	● ● ● ● *	● ● ● ● *	● ● ● ● *	● ● ● ● *	● ● ● ● *	● ● ● ● *
N	● ● ● ● *	● ● ● ● *	● ● ● ● *	● ● ● ● *	● ● ● ● *	● ● ● ● *
S	● ● ● ● *	● ● ● ● *	● ● ● ● *	● ● ● ● *	● ● ● ● *	● ● ● ● *
H	● ● ● ● *	● ● ● ● *	● ● ● ● *	● ● ● ● *	● ● ● ● *	● ● ● ● *

Application	Chipbreaker	Designation		Corner radius	Coated				Coated cermet	Cermet	
		Inch	Metric		T9105	T9115	T9125	T9135	GT9530	NS9530	NS520
Finishing		TS	TNMG 331 TS	TNMG160404-TS	0.016"	●	● ● ● ● *	●	● ● ● ● *	● ● ● ● *	
			TNMG 332 TS	TNMG160408-TS	0.031"	●	● ● ● ● *	●	● ● ● ● *	● ● ● ● *	
			TNMG 333 TS	TNMG160412-TS	0.047"	●	● ● ● ● *	●	● ● ● ● *	● ● ● ● *	
Finishing to medium cutting (Wiper)		SW	TNMG 232E-SW	TNMG110408E-SW	0.031"	●					
			TNMG 233E-SW	TNMG110412E-SW	0.047"	●					
			TNMG 332-SW	TNMG160408-SW	0.031"	●					
			TNMG 333-SW	TNMG160412-SW	0.047"	●					
High feed, small depth of cut		AS	TNMG 331 AS	TNMG160404-AS	0.016"		● ● ● ● *			● ● ● ● *	
			TNMG 332 AS	TNMG160408-AS	0.031"	●	● ● ● ● *			● ● ● ● *	
			TNMG 333 AS	TNMG160412-AS	0.047"	●	● ● ● ● *			● ● ● ● *	
Boring (Double sided)		CB	TNMG 221 CB	TNMG110304-CB	0.016"	●				● ● ● ● *	
			TNMG 222 CB	TNMG110308-CB	0.031"	●				● ● ● ● *	
Finishing		NS	TNMG 331 NS	TNMG160404-NS	0.016"	●	● ● ● ● *			● ● ● ● *	
			TNMG 332 NS	TNMG160408-NS	0.031"	●	● ● ● ● *			● ● ● ● *	

● : Line up

Reference pages

External toolholders → **B206** -
 J series toolholders → **B377** -

Internal toolholders → **B296** -



Insert

Negative



T

TurnLine - Insert

● : Continuous cutting
 ● : Light interrupted cutting
 * : Heavy interrupted cutting

NEGATIVE TYPE



Triangular, 60°
with hole

Material	Steel	Stainless	Cast iron	Non-ferrous	Superalloys	Hard materials
P	●	●	●	●	●	●
M	●	●	●	●	●	●
K	●	●	●	●	●	●
N	●	●	●	●	●	●
S	●	●	●	●	●	●
H	●	●	●	●	●	●

Application	Chipbreaker	Designation		Corner radius	Coated										Coated cermet		Cermet		Un-coated		
		Inch	Metric		T9105	T9115	T9125	T9135	AH630	T515	T5105	T5115	T5125	AH110	AH120	GT9530	GT720	NS9530	NS520	TH10	
Finishing to medium cutting		ZM	TNMG 331 ZM	TNMG160404-ZM	0.016"	●	●	●	●												
			TNMG 332 ZM	TNMG160408-ZM	0.031"	●	●	●							●		●				
			TNMG 333 ZM	TNMG160412-ZM	0.047"	●	●	●													
			TNMG 432 ZM	TNMG220408-ZM	0.031"			●													
			TNMG 433 ZM	TNMG220412-ZM	0.047"			●													
Medium cutting		DM	TNMG 332 DM	TNMG160408-DM	0.031"	●	●	●	●												
			TNMG 333 DM	TNMG160412-DM	0.047"	●	●														
			TNMG 434 DM	TNMG220416-DM	0.063"								●								
		All-round	TNMG 221	TNMG110304	0.016"	●	●				●	●	●					●		●	
			TNMG 222	TNMG110308	0.031"	●	●				●	●	●					●		●	
			TNMG 321	TNMG160304	0.016"															●	
			TNMG 322	TNMG160308	0.031"															●	
			TNMG 331	TNMG160404	0.016"	●	●	●	●		●	●	●	●	●	●			●	●	●
			TNMG 332	TNMG160408	0.031"	●	●	●	●		●	●	●	●	●	●	●		●	●	●
			TNMG 333	TNMG160412	0.047"	●	●	●	●		●	●	●	●	●	●					●
			TNMG 334	TNMG160416	0.063"	●	●	●			●	●	●								●
			TNMG 335	TNMG160420	0.078"	●	●	●													●
			TNMG 432	TNMG220408	0.031"	●	●	●	●		●	●	●								●
			TNMG 433	TNMG220412	0.047"	●	●	●	●		●	●	●								●
			TNMG 434	TNMG220416	0.063"	●	●	●			●	●	●								●
			TNMG 542	TNMG270608	0.031"		●								●						
			TNMG 543	TNMG270612	0.047"		●								●						
	TNMG 544	TNMG270616	0.063"										●								
Finishing to medium cutting		27	TNMG 322 TN27	TNMG160308-27	0.031"		●														
			TNMG 331 TN27	TNMG160404-27	0.016"	●	●														
			TNMG 332 TN27	TNMG160408-27	0.031"	●	●											●			
			TNMG 333 TN27	TNMG160412-27	0.047"	●	●														
			TNMG 431 TN27	TNMG220404-27	0.016"		●														
			TNMG 432 TN27	TNMG220408-27	0.031"		●							●							
			TNMG 433 TN27	TNMG220412-27	0.047"		●														

● : Line up

Reference pages

External toolholders → **B211** -
 J series toolholders → **B377** -

Internal toolholders → **B323** -



Insert

Negative



T



Insert

Negative

T

TurnLine - Insert

● : Continuous cutting
 ● : Light interrupted cutting
 * : Heavy interrupted cutting

NEGATIVE TYPE



Triangular, 60° with hole

	P	M	K	N	S	H														
Steel	●●●*	●	●	●	●	●	●	●	●	●	●	●	●	●	●	●	●	●	●	●
Stainless	●	●	●	●	●	●	●	●	●	●	●	●	●	●	●	●	●	●	●	●
Cast iron	●●	●	●	●	●	●	●	●	●	●	●	●	●	●	●	●	●	●	●	●
Non-ferrous	●	●	●	●	●	●	●	●	●	●	●	●	●	●	●	●	●	●	●	●
Superalloys	●	●	●	●	●	●	●	●	●	●	●	●	●	●	●	●	●	●	●	●
Hard materials	●	●	●	●	●	●	●	●	●	●	●	●	●	●	●	●	●	●	●	●

Application	Chipbreaker	Designation		Corner radius	Coated													Coated cermet	Cermet	Un-coated			
		Inch	Metric		T9115	T9125	T9135	T6120	T6130	AH630	AH645	T515	T5105	T5115	T5125	AH110	AH120	AH725	GH330	GT720	NS9530	TH10	
	28	TNMG 331 TN28	TNMG160404-28	0.016"											●	●	●	●	●	●	●	●	
		TNMG 332 TN28	TNMG160408-28	0.031"											●	●							●
		TNMG 431 TN28	TNMG220404-28	0.016"											●	●							●
		TNMG 432 TN28	TNMG220408-28	0.031"											●	●							●
	32	TNMG 666 TN32	TNMG330924-32	0.094"					●							●							
	33	TNMG 331 TN33	TNMG160404-33	0.016"																			●
		TNMG 332 TN33	TNMG160408-33	0.031"																			●
		TNMG 334 TN33	TNMG160416-33	0.063"	●																		
		TNMG 431 TN33	TNMG220404-33	0.016"	●													●					
		TNMG 433 TN33	TNMG220412-33	0.047"		●																	
		TNMG 434 TN33	TNMG220416-33	0.063"	●																		
	37	TNMG 331 TN37	TNMG160404-37	0.016"	●													●		●			
		TNMG 332 TN37	TNMG160408-37	0.031"	●													●		●			
	38	TNMG 331 TN38	TNMG160404-38	0.016"														●					
		TNMG 332 TN38	TNMG160408-38	0.031"														●					
	SM	TNMG 231E-SM	TNMG110404E-SM	0.016"			●	●	●														
		TNMG 232E-SM	TNMG110408E-SM	0.031"			●	●	●														
		TNMG 331 SM	TNMG160404-SM	0.016"			●	●	●	●							●						
		TNMG 332 SM	TNMG160408-SM	0.031"			●	●	●	●							●						
		TNMG 333 SM	TNMG160412-SM	0.047"			●	●	●	●													
		TNMG 432 SM	TNMG220408-SM	0.031"			●	●	●	●													
		TNMG 433 SM	TNMG220412-SM	0.047"			●	●	●	●													
		TNMG 666 SM	TNMG330924-SM	0.094"			●	●															
	CM	TNMG 331 CM	TNMG160404-CM	0.016"						●	●	●	●										
		TNMG 332 CM	TNMG160408-CM	0.031"						●	●	●	●										
		TNMG 333 CM	TNMG160412-CM	0.047"						●	●	●	●										
		TNMG 432 CM	TNMG220408-CM	0.031"							●	●	●										
		TNMG 433 CM	TNMG220412-CM	0.047"							●	●	●										

Reference pages

External toolholders → B206 -
J series toolholders → B377 -

Internal toolholders → B296 -

● : Line up

TurnLine - Insert

● : Continuous cutting
 ● : Light interrupted cutting
 * : Heavy interrupted cutting

NEGATIVE TYPE



Triangular, 60° with hole

Material	Steel	Stainless	Cast iron	Non-ferrous	Superalloys	Hard materials
P	●	●	●	●	●	●
M	●	●	●	●	●	●
K	●	●	●	●	●	●
N	●	●	●	●	●	●
S	●	●	●	●	●	●
H	●	●	●	●	●	●

Application	Chipbreaker	Designation		Corner radius	Coated							Cermet	Uncoated							
		Inch	Metric		T6120	T6130	AH630	AH645	AH120	AH8005	AH8015	AH905	GH110	GH330	SH725	NS9530	TH10	KS20		
Medium cutting		P	TNGG 330.5 R-P	TNGG160402R-P	0.008"															
			TNGG 330.5 L-P	TNGG160402L-P	0.008"															
			TNGG 331 R-P	TNGG160404R-P	0.016"															
			TNGG 331 L-P	TNGG160404L-P	0.016"															
			TNGG 332 R-P	TNGG160408R-P	0.031"															
			TNGG 332 L-P	TNGG160408L-P	0.031"															
Medium cutting (Sharp edge)		P	TNGG 330.5FR-P	TNGG160402FR-P	0.008"															
			TNGG 330.5FL-P	TNGG160402FL-P	0.008"															
			TNGG 331FR-P	TNGG160404FR-P	0.016"															
			TNGG 331FL-P	TNGG160404FL-P	0.016"															
			TNGG 332FR-P	TNGG160408FR-P	0.031"															
			TNGG 332FL-P	TNGG160408FL-P	0.031"															
Finishing to medium cutting		HRM	TNMG 331 HRM	TNMG160404-HRM	0.016"															
			TNMG 332 HRM	TNMG160408-HRM	0.031"															
			TNMG 333 HRM	TNMG160412-HRM	0.047"															
Medium cutting		HMM	TNMG 331 HMM	TNMG160404-HMM	0.016"															
			TNMG 332 HMM	TNMG160408-HMM	0.031"															
			TNMG 333 HMM	TNMG160412-HMM	0.047"															
		SA	TNMG 331 SA	TNMG160404-SA	0.016"	●	●	●	●	●										
			TNMG 332 SA	TNMG160408-SA	0.031"	●	●	●	●	●									●	
			TNMG 333 SA	TNMG160412-SA	0.047"	●	●	●	●	●									●	
	TNMG 432 SA	TNMG220408-SA	0.031"	●	●	●	●	●									●			
	TNMG 433 SA	TNMG220412-SA	0.047"	●	●	●	●													

● : Line up

Reference pages

External toolholders → **B211** -
 J series toolholders → **B377** -

Internal toolholders → **B323** -



Insert

Negative





Insert

TurnLine - Insert

● : Continuous cutting
 ◐ : Light interrupted cutting
 ✱ : Heavy interrupted cutting

NEGATIVE TYPE



Triangular, 60°
with hole

	P	M	K	N	S	H																					
Steel	●	●	●	●			●	●	●	●	✱	✱	✱	✱					●	●	●	●	●				
Stainless		●																		●	●	●	●	●			
Cast iron	●		●				●	●	●	●					●	●	●	●		●	●	●	●	●	●	●	●
Non-ferrous				●																	●	●	●	●	●	●	●
Superalloys					●															●	●	●					
Hard materials						●																					

Negative

Application	Chipbreaker	Designation		Corner radius	Coated														Cermets									
		Inch	Metric		T9105	T9115	T9125	T9135	T6130	AH630	AH645	T515	T5105	T5115	T5125	AH120	AH725	GH330	NS9530									
Medium cutting		S	TNMG 331 R-S	TNMG160404R-S	0.016"	●	●	●	●	●	●									●	●			●				
			TNMG 331 L-S	TNMG160404L-S	0.016"			●	●	●	●	●									●	●			●			
			TNMG 332 R-S	TNMG160408R-S	0.031"			●	●	●	●	●									●	●			●			
			TNMG 332 L-S	TNMG160408L-S	0.031"			●	●	●	●	●									●	●			●			
			TNMG 431 R-S	TNMG220404R-S	0.016"			●	●	●	●	●										●	●			●		
			TNMG 431 L-S	TNMG220404L-S	0.016"			●	●	●	●	●										●	●			●		
			TNMG 432 R-S	TNMG220408R-S	0.031"			●	●	●	●	●										●	●			●		
			TNMG 432 L-S	TNMG220408L-S	0.031"			●	●	●	●	●										●	●			●		
Medium to heavy cutting		TH	TNMG 432 TH	TNMG220408-TH	0.031"	●	●	●	●											●								
			TNMG 433 TH	TNMG220412-TH	0.047"	●	●	●	●																			
		THS	TNMG 432 THS	TNMG220408-THS	0.031"	●	●	●																				
			TNMG 433 THS	TNMG220412-THS	0.047"	●	●	●																				
		CH	TNMG 331 CH	TNMG160404-CH	0.016"								●	●	●	●												
			TNMG 332 CH	TNMG160408-CH	0.031"								●	●	●	●												
			TNMG 333 CH	TNMG160412-CH	0.047"								●	●	●	●												
			TNMG 432 CH	TNMG220408-CH	0.031"								●	●	●													
		TNMG 433 CH	TNMG220412-CH	0.047"								●	●	●														
		TNMG 434 CH	TNMG220416-CH	0.063"								●	●	●														

● : Line up

Reference pages

External toolholders → **B211** -
 J series toolholders → **B377** -

Internal toolholders → **B323** -

TurnLine - Insert

● : Continuous cutting
 ● : Light interrupted cutting
 ✱ : Heavy interrupted cutting

NEGATIVE TYPE



**Triangular, 60°
with hole**

	P	M	K	N	S	H
Steel	●					
Stainless		●				
Cast iron	●		●			
Non-ferrous				●		
Superalloys					●	
Hard materials						●

Application	Chipbreaker	Designation		Corner radius	Coated					Coated cermet	Cermet		Uncoated		Ceramics				
		Inch	Metric		T515	T5105	T5115	T5125	GH110	GT720	NS520	TH03	TH10	FX105	LX21	LX11			
Finishing to medium cutting		-	TNMA 331	TNMA160404	0.016"	●	●	●	●										
			TNMA 332	TNMA160408	0.031"	●	●	●	●		●			●		●			
			TNMA 333	TNMA160412	0.047"	●	●	●	●							●			
			TNMA 334	TNMA160416	0.063"		●	●	●										
			TNMA 335	TNMA160420	0.078"		●	●	●										
			TNMA 431	TNMA220404	0.016"		●	●	●										
			TNMA 432	TNMA220408	0.031"		●	●	●										
			TNMA 433	TNMA220412	0.047"		●	●	●										
			TNMA 434	TNMA220416	0.063"		●	●	●										
			-	TNGA 221	TNGA110304	0.016"									●				
				TNGA 222	TNGA110308	0.031"										●			
				TNGA 321	TNGA160304	0.016"										●			
				TNGA 322	TNGA160308	0.031"										●			
				TNGA 3305	TNGA160402	0.008"													●
				TNGA 331	TNGA160404	0.016"				●			●	●	●	●	●	●	●
				TNGA 332	TNGA160408	0.031"				●			●	●	●	●	●	●	●
				TNGA 333	TNGA160412	0.047"						●		●	●	●	●	●	●
				TNGA 334	TNGA160416	0.063"									●	●	●	●	●
				TNGA 432	TNGA220408	0.031"								●					

● : Line up



Insert

Negative



Reference pages

External toolholders → B211 -
 J series toolholders → B377 -

Internal toolholders → B323 -

TurnLine - Insert

● : Continuous cutting
 ● : Light interrupted cutting
 * : Heavy interrupted cutting

NEGATIVE TYPE



	P	M	K	N	S	H
Steel	●●●●●●	●●●●●●	●●●●●●	●●●●●●	●●●●●●	●●●●●●
Stainless	●●●●●●	●●●●●●	●●●●●●	●●●●●●	●●●●●●	●●●●●●
Cast iron	●●●●●●	●●●●●●	●●●●●●	●●●●●●	●●●●●●	●●●●●●
Non-ferrous	●●●●●●	●●●●●●	●●●●●●	●●●●●●	●●●●●●	●●●●●●
Superalloys	●●●●●●	●●●●●●	●●●●●●	●●●●●●	●●●●●●	●●●●●●
Hard materials	●●●●●●	●●●●●●	●●●●●●	●●●●●●	●●●●●●	●●●●●●

Application	Chipbreaker	Designation		Corner radius	Coated								Coated cermet		Cermet		Uncoated		
		Inch	Metric		T9105	T9115	T9125	T9135	T6120	T6130	AH630	AH120	GH110	GH330	GT9530	GT720	NS9530	NS520	TH10
Precision finishing		TF	VNMG 331 TF	VNMG160404-TF	0.016"														
			VNMG 332 TF	VNMG160408-TF	0.031"									●		●			
		01	VNGG 330.5-01	VNGG160402-01	0.008"											●	●	●	
			VNGG 331-01	VNGG160404-01	0.016"											●	●	●	
			VNGG 332-01	VNGG160408-01	0.031"											●	●		
Finishing to medium cutting		P	VNGG 331 FRP	VNGG160404R-P	0.016"													●	
			VNGG 332 FRP	VNGG160408R-P	0.031"														●
Finishing		TSF	VNMG 2.330.5E-TSF	VNMG120402E-TSF	0.008"	●	●							●		●			
				VNMG 2.331E-TSF	VNMG120404E-TSF	0.016"	●	●							●		●		
				VNMG 2.332E-TSF	VNMG120408E-TSF	0.031"	●	●							●		●		
			VNMG 330.5 TSF	VNMG160402-TSF	0.008"														
			VNMG 331 TSF	VNMG160404-TSF	0.016"	●	●	●	●			●		●		●		●	
			VNMG 332 TSF	VNMG160408-TSF	0.031"	●	●	●	●			●		●		●		●	
			VNMG 333 TSF	VNMG160412-TSF	0.047"	●	●	●	●										
		ZF	VNMG 331 ZF	VNMG160404-ZF	0.016"	●	●	●						●		●			
			VNMG 332 ZF	VNMG160408-ZF	0.031"	●	●	●						●		●			
			VNMG 333 ZF	VNMG160412-ZF	0.047"	●	●	●											
	11	VNMG 331 TN11	VNMG160404-11	0.016"											●		●		
			VNMG 332 TN11	VNMG160408-11	0.031"											●			
			VNMG 333 TN11	VNMG160412-11	0.047"										●		●		
	SF	VNMG 331 SF	VNMG160404-SF	0.016"					●	●	●								
			VNMG 332 SF	VNMG160408-SF	0.031"					●	●	●							

Reference pages

External toolholders → B207 - Internal toolholders → B298, B325, B328
 TungCap → B224

● : Line up





Insert

TurnLine - Insert

● : Continuous cutting
 ● : Light interrupted cutting
 * : Heavy interrupted cutting

NEGATIVE TYPE



Material	T9105	T9115	T9125	T9135	T6120	T6130	AH630	AH645	T5105	T5115	AH110	AH120	AH8005	AH8015	GH330	GT9530	NS9530	NS520	
P Steel	●	●●●	●●	●●	●	●	●	●	●	●	●	●	●	●	●	●	●	●	●
M Stainless					●	●	●	●			●	●	●	●	●				
K Cast iron	●●●								●	●	●	●	●	●	●	●	●	●	●
N Non-ferrous																			
S Superalloys											●	●	●	●					
H Hard materials																			

Negative

Application	Chipbreaker	Designation		Corner radius	Coated												Coated cermet	Cermets				
		Inch	Metric		T9105	T9115	T9125	T9135	T6120	T6130	AH630	AH645	T5105	T5115	AH110	AH120	AH8005	AH8015	GH330	GT9530	NS9530	NS520
Finishing	CF 	VNMG 331 CF	VNMG160404-CF	0.016"																		
		VNMG 332 CF	VNMG160408-CF	0.031"							●	●										
	HRF 	VNMG 331 HRF	VNMG160404-HRF	0.016"											●	●						
		VNMG 332 HRF	VNMG160408-HRF	0.031"											●	●						
	TS 	VNMG 331 TS	VNMG160404-TS	0.016"	●	●	●											●		●	●	
		VNMG 332 TS	VNMG160408-TS	0.031"	●	●	●											●		●	●	
VNMG 333 TS		VNMG160412-TS	0.047"	●	●	●																
SS 	VNMG 2.331E-SS	VNMG120404E-SS	0.016"				●	●	●	●												
	VNMG 2.332E-SS	VNMG120408E-SS	0.031"				●	●	●	●												
	VNMG 331 SS	VNMG160404-SS	0.016"				●	●	●	●		●			●							
	VNMG 332 SS	VNMG160408-SS	0.031"				●	●	●	●		●			●							
	VNMG 333 SS	VNMG160412-SS	0.047"				●	●	●	●		●			●							
Medium cutting	TM 	VNMG 2.331E-TM	VNMG120404E-TM	0.016"	●	●																
		VNMG 2.332E-TM	VNMG120408E-TM	0.031"	●	●																
		VNMG 331 TM	VNMG160404-TM	0.016"	●	●	●	●		●		●	●									
		VNMG 332 TM	VNMG160408-TM	0.031"	●	●	●	●		●		●	●									
		VNMG 333 TM	VNMG160412-TM	0.047"	●	●	●	●		●		●										

● : Line up

Reference pages

External toolholders → B207 - Internal toolholders → B298, B325, B328
 TungCap → B224

TurnLine - Insert





● : Continuous cutting
 ●c : Light interrupted cutting
 ※ : Heavy interrupted cutting

NEGATIVE TYPE

Rhombic, 35°
with hole

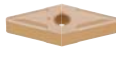

	P	M	K	N	S	H																																
Steel	●	●c	●c	●c	●c	●c	●	●	●	●c	●c	●c	●c	●c	●c	●c	●c	●c	●c	●c	●c	●c	●c	●c	●c	●c	●c	●c	●c	●c	●c	●c	●c	●c	●c	●c		
Stainless							●	●	●	●c	●c	●c	●c	●c	●c	●c	●c	●c	●c	●c	●c	●c	●c	●c	●c	●c	●c	●c	●c	●c	●c	●c	●c	●c	●c	●c	●c	
Cast iron	●c	●c	●c	●c	●c	●c	●c	●c	●c	●c	●c	●c	●c	●c	●c	●c	●c	●c	●c	●c	●c	●c	●c	●c	●c	●c	●c	●c	●c	●c	●c	●c	●c	●c	●c	●c	●c	●c
Non-ferrous																																						
Superalloys							●	●	●c	●c	●c	●c	●c	●c	●c	●c	●c	●c	●c	●c	●c	●c	●c	●c	●c	●c	●c	●c	●c	●c	●c	●c	●c	●c	●c	●c	●c	●c
Hard materials																																						

Application	Chipbreaker	Designation		Corner radius	Coated												Coated cermet	Cermet	Uncoated			
		Inch	Metric		T9105	T9115	T9125	T9135	T515	T5105	T5115	T5125	AH110	AH120	GT9530	NS9530	TH10					
Finishing to medium cutting		TQ	VNMG 331 TQ	VNMG160404-TQ	0.016"													●	●			
			VNMG 332 TQ	VNMG160408-TQ	0.031"														●	●		
		ZM	VNMG 332 ZM	VNMG160408-ZM	0.031"	●	●	●														
			VNMG 333 ZM	VNMG160412-ZM	0.047"	●	●	●														
Medium cutting		DM	VNMG 332 DM	VNMG160408-DM	0.031"	●	●	●	●													
			VNMG 333 DM	VNMG160412-DM	0.047"	●	●	●														
		All-round	VNMG 331	VNMG160404	0.016"	●	●	●	●	●	●	●	●	●	●	●	●	●		●	●	
			VNMG 332	VNMG160408	0.031"	●	●	●	●	●	●	●	●	●	●	●	●	●	●		●	●
			VNMG 333	VNMG160412	0.047"	●	●		●	●	●	●									●	
		28	VNMG 331 TN28	VNMG160404-28	0.016"													●				
			VNMG 332 TN28	VNMG160408-28	0.031"														●			
		33	VNMG 331 TN33	VNMG160404-33	0.016"		●											●			●	
			VNMG 332 TN33	VNMG160408-33	0.031"		●	●											●			●

● : Line up

Reference pages

External toolholders → B211 - Internal toolholders → B325, B328
 TungCap → B224



Insert

Negative





Insert

TurnLine - Insert

● : Continuous cutting
●c : Light interrupted cutting
* : Heavy interrupted cutting

NEGATIVE TYPE



Rhombic, 35° with hole

P	Steel		●c	*	●c	*										●c					
M	Stainless		●	●c	●c	*						●	●c								
K	Cast iron						●	●c	*					●c			●				
N	Non-ferrous																●				
S	Superalloys												●	●c	●c						
H	Hard materials																				●

Negative

Application	Chipbreaker	Designation		Corner radius	Coated									Cermets	Uncoated	Ceramics							
		Inch	Metric		T6120	T6130	AH630	AH645	T5105	T5115	T5125	AH8005	AH8015				AH905	NS520	TH10	LX11			
Medium cutting		SM	VNMG 2.331E-SM	VNMG120404E-SM	0.016"	●	●	●	●														
			VNMG 2.332E-SM	VNMG120408E-SM	0.031"	●	●	●	●														
			VNMG 331 SM	VNMG160404-SM	0.016"	●	●	●	●														
			VNMG 332 SM	VNMG160408-SM	0.031"	●	●	●	●														
			VNMG 333 SM	VNMG160412-SM	0.047"	●	●	●	●														
			CM	VNMG 332 CM	VNMG160408-CM	0.031"					●	●	●										
		VNMG 333 CM	VNMG160412-CM	0.047"					●	●	●												
Finishing to medium cutting		HRM	VNMG 331 HRM	VNMG160404-HRM	0.016"								●	●									
			VNMG 332 HRM	VNMG160408-HRM	0.031"									●	●								
			VNMG 333 HRM	VNMG160412-HRM	0.047"										●	●							
Medium cutting		HMM	VNMG 331 HMM	VNMG160404-HMM	0.016"											●							
			VNMG 332 HMM	VNMG160408-HMM	0.031"												●						
			VNMG 333 HMM	VNMG160412-HMM	0.047"												●						
Finishing to medium cutting		-	VNMA 330.5	VNMA160402	0.008"													●					
			VNMA 331	VNMA160404	0.016"					●	●	●			●		●						
			VNMA 332	VNMA160408	0.031"					●	●	●			●		●						
			VNGA 331	VNGA160404	0.016"																●		
			VNGA 332	VNGA160408	0.031"																	●	



Rhombic, 35° without hole

P	Steel																				
M	Stainless																				
K	Cast iron						●c														
N	Non-ferrous																				
S	Superalloys																				
H	Hard materials																				

V

Application	Chipbreaker	Designation		Corner radius	Ceramics																			
		Inch	Metric		FX105																			
Finishing to medium cutting		VNGD 353	VNGD160712	0.047"	●																			

Reference pages

External toolholders → B207 - Internal toolholders → B298, B325, B328

TungCap → B224

VNGD...: External toolholders → B272

● : Line up

TurnLine - Insert

● : Continuous cutting
 ● : Light interrupted cutting
 * : Heavy interrupted cutting

NEGATIVE TYPE



**Trigon, 80°
with hole**

	P	M	K	N	S	H
Steel	●●●●●	●●●●●	●●●●●	●●●●●	●●●●●	●●●●●
Stainless	●●●●●	●●●●●	●●●●●	●●●●●	●●●●●	●●●●●
Cast iron	●●●●●	●●●●●	●●●●●	●●●●●	●●●●●	●●●●●
Non-ferrous	●●●●●	●●●●●	●●●●●	●●●●●	●●●●●	●●●●●
Superalloys	●●●●●	●●●●●	●●●●●	●●●●●	●●●●●	●●●●●
Hard materials	●●●●●	●●●●●	●●●●●	●●●●●	●●●●●	●●●●●

Application	Chipbreaker	Designation		Corner radius	Coated						Coated cermet		Cermet				
		Inch	Metric		T9105	T9115	T9125	T9135	T5115	AH120	GT9530	GT720	NS9530	NS520			
Precision finishing		TF	WNMG 431 TF	WNMG080404-TF	0.016"	●	●	●	●	●	●	●	●	●	●		
			WNMG 432 TF	WNMG080408-TF	0.031"												
		01	WNGG 430.5-01	WNGG080402-01	0.008"												
Finishing			TSF	WNMG 331E-TSF	WNMG060404E-TSF	0.016"	●	●				●		●			
				WNMG 332E-TSF	WNMG060408E-TSF	0.031"	●	●				●		●			
				WNMG 333E-TSF	WNMG060412E-TSF	0.047"	●	●				●		●			
				WNMG 331 TSF	WNMG060404-TSF	0.016"	●	●									
				WNMG 332 TSF	WNMG060408-TSF	0.031"	●	●	●								
				WNMG 431 TSF	WNMG080404-TSF	0.016"	●	●	●		●				●		
				WNMG 432 TSF	WNMG080408-TSF	0.031"	●	●	●		●				●		
				WNMG 433 TSF	WNMG080412-TSF	0.047"	●	●	●	●	●						
Finishing (Wiper)			FW	WNMG 331E-FW	WNMG060404E-FW	0.016"	●	●	●			●		●			
				WNMG 332E-FW	WNMG060408E-FW	0.031"	●	●	●			●		●			
				WNMG 431 FW	WNMG080404-FW	0.016"	●	●				●		●			
				WNMG 432 FW	WNMG080408-FW	0.031"	●	●	●			●		●			
			AFW	WNMG 331 AFW	WNMG060404-AFW	0.016"	●	●						●			
				WNMG 332 AFW	WNMG060408-AFW	0.031"	●	●	●	●				●			
				WNMG 431 AFW	WNMG080404-AFW	0.016"	●	●						●			
				WNMG 432 AFW	WNMG080408-AFW	0.031"	●	●	●	●	●			●			
Finishing			ZF	WNMG 331E-ZF	WNMG060404E-ZF	0.016"	●	●									
				WNMG 331 ZF	WNMG060404-ZF	0.016"	●	●									
				WNMG 332 ZF	WNMG060408-ZF	0.031"	●	●									
				WNMG 431 ZF	WNMG080404-ZF	0.016"	●	●	●		●			●			
				WNMG 432 ZF	WNMG080408-ZF	0.031"	●	●	●		●			●			
				WNMG 433 ZF	WNMG080412-ZF	0.047"	●										

● : Line up

Reference pages

External toolholders → B202 - Internal toolholders → B295 -
 TungCap → B224, F009 -





Insert

TurnLine - Insert

● : Continuous cutting
 ● : Light interrupted cutting
 * : Heavy interrupted cutting

NEGATIVE TYPE



Trigon, 80° with hole

P	Steel	●●	●●*	●●	●	●	●●										●●		●●●●
M	Stainless				●	●	●			●	●								
K	Cast iron	●●						●	●								●●		●●●●
N	Non-ferrous																		
S	Superalloys									●	●								
H	Hard materials																		

Negative

Application	Chipbreaker	Designation		Corner radius	Coated										Coated cermet	Cermet						
		Inch	Metric		T9115	T9125	T9135	T6120	T6130	AH630	T5105	T5115	AH8005	AH8015	GT9530	NS9530	NS520					
Finishing		11	WNMG 431 TN11	WNMG080404-11	0.016"															●		
			WNMG 432 TN11	WNMG080408-11	0.031"																●	
Finishing of mild steels		17	WNMG 431 TN17	WNMG080404-17	0.016"															●		
			WNMG 432 TN17	WNMG080408-17	0.031"																●	
Finishing		SF	WNMG 331 SF	WNMG060404-SF	0.016"				●	●	●											
			WNMG 332 SF	WNMG060408-SF	0.031"				●	●	●											
			WNMG 431 SF	WNMG080404-SF	0.016"				●	●	●											
			WNMG 432 SF	WNMG080408-SF	0.031"				●	●	●											
Finishing		CF	WNMG 431 CF	WNMG080404-CF	0.016"							●	●									
			WNMG 432 CF	WNMG080408-CF	0.031"								●	●								
			WNMG 433 CF	WNMG080412-CF	0.047"								●	●								
Finishing		HRF	WNMG 431 HRF	WNMG080404-HRF	0.016"															●	●	
			WNMG 432 HRF	WNMG080408-HRF	0.031"																●	●
Finishing		TS	WNMG 431 TS	WNMG080404-TS	0.016"	●	●	●												●	●	
			WNMG 432 TS	WNMG080408-TS	0.031"	●	●	●													●	●
			WNMG 433 TS	WNMG080412-TS	0.047"	●	●	●														

● : Line up

Reference pages

External toolholders → **B202** - Internal toolholders → **B295** -
 TungCap → **B224, F009** -

TurnLine - Insert

● : Continuous cutting
 ● : Light interrupted cutting
 * : Heavy interrupted cutting

NEGATIVE TYPE



**Trigon, 80°
with hole**

Material	Steel	Stainless	Cast iron	Non-ferrous	Superalloys	Hard materials
P	●	●	●	●	●	●
M	●	●	●	●	●	●
K	●	●	●	●	●	●
N	●	●	●	●	●	●
S	●	●	●	●	●	●
H	●	●	●	●	●	●

Application	Chipbreaker	Designation		Corner radius	Coated											Cermet				
		Inch			Metric		T9105	T9115	T9125	T9135	T6120	T6130	AH120	AH630	AH645	T515	T5115	GH330	NS9530	
		Inch	Metric		T9105	T9115	T9125	T9135	T6120	T6130	AH120	AH630	AH645	T515	T5115	GH330	NS9530			
Finishing to medium cutting (Wiper)		SW	WNMG 332E-SW	WNMG060408E-SW	0.031"	●	●	●												
			WNMG 333E-SW	WNMG060412E-SW	0.047"	●	●	●												
			WNMG 432 SW	WNMG080408-SW	0.031"	●	●	●						●	●					
			WNMG 433 SW	WNMG080412-SW	0.047"		●	●						●	●					
		ASW	WNMG 332 ASW	WNMG060408-ASW	0.031"	●	●	●												
			WNMG 333 ASW	WNMG060412-ASW	0.047"	●	●	●	●											
			WNMG 432 ASW	WNMG080408-ASW	0.031"	●	●	●	●											
			WNMG 433 ASW	WNMG080412-ASW	0.047"	●	●	●	●											
High feed, small depth of cut		AS	WNMG 431 AS	WNMG080404-AS	0.016"	●												●		
			WNMG 432 AS	WNMG080408-AS	0.031"	●	●	●	●										●	
			WNMG 433 AS	WNMG080412-AS	0.047"	●	●	●	●											
Boring (Double sided)		CB	WNMG 331 CB	WNMG060404-CB	0.016"			●										●		
			WNMG 332 CB	WNMG060408-CB	0.031"			●											●	
Finishing		NS	WNMG 431 NS	WNMG080404-NS	0.016"		●	●										●		
			WNMG 432 NS	WNMG080408-NS	0.031"		●	●											●	
		SS	WNMG 331E-SS	WNMG060404E-SS	0.016"									●	●					
			WNMG 332E-SS	WNMG060408E-SS	0.031"									●	●					
			WNMG 333E-SS	WNMG060412E-SS	0.047"									●	●					
			WNMG 431 SS	WNMG080404-SS	0.016"					●	●	●	●			●				
			WNMG 432 SS	WNMG080408-SS	0.031"					●	●	●	●			●				
			WNMG 433 SS	WNMG080412-SS	0.047"					●	●	●	●			●				

● : Line up

Reference pages

External toolholders → B202 - Internal toolholders → B295 -
 TungCap → B224, F009 -



Insert

Negative





Insert

TurnLine - Insert

● : Continuous cutting
●c : Light interrupted cutting
* : Heavy interrupted cutting

NEGATIVE TYPE



**Trigon, 80°
with hole**

P Steel	● ● ● ● ● *	● ● ● ● ●	● ● ● ● ●	● ● ● ● ●	● ● ● ● ●	● ● ● ● ●	● ● ● ● ●	● ● ● ● ●	● ● ● ● ●	● ● ● ● ●	● ● ● ● ●	● ● ● ● ●	● ● ● ● ●	● ● ● ● ●	● ● ● ● ●	● ● ● ● ●	● ● ● ● ●	● ● ● ● ●	● ● ● ● ●	● ● ● ● ●
M Stainless	● ● ● ● ● *	● ● ● ● ●	● ● ● ● ●	● ● ● ● ●	● ● ● ● ●	● ● ● ● ●	● ● ● ● ●	● ● ● ● ●	● ● ● ● ●	● ● ● ● ●	● ● ● ● ●	● ● ● ● ●	● ● ● ● ●	● ● ● ● ●	● ● ● ● ●	● ● ● ● ●	● ● ● ● ●	● ● ● ● ●	● ● ● ● ●	● ● ● ● ●
K Cast iron	● ● ● ● ● *	● ● ● ● ●	● ● ● ● ●	● ● ● ● ●	● ● ● ● ●	● ● ● ● ●	● ● ● ● ●	● ● ● ● ●	● ● ● ● ●	● ● ● ● ●	● ● ● ● ●	● ● ● ● ●	● ● ● ● ●	● ● ● ● ●	● ● ● ● ●	● ● ● ● ●	● ● ● ● ●	● ● ● ● ●	● ● ● ● ●	● ● ● ● ●
N Non-ferrous	● ● ● ● ● *	● ● ● ● ●	● ● ● ● ●	● ● ● ● ●	● ● ● ● ●	● ● ● ● ●	● ● ● ● ●	● ● ● ● ●	● ● ● ● ●	● ● ● ● ●	● ● ● ● ●	● ● ● ● ●	● ● ● ● ●	● ● ● ● ●	● ● ● ● ●	● ● ● ● ●	● ● ● ● ●	● ● ● ● ●	● ● ● ● ●	● ● ● ● ●
S Superalloys	● ● ● ● ● *	● ● ● ● ●	● ● ● ● ●	● ● ● ● ●	● ● ● ● ●	● ● ● ● ●	● ● ● ● ●	● ● ● ● ●	● ● ● ● ●	● ● ● ● ●	● ● ● ● ●	● ● ● ● ●	● ● ● ● ●	● ● ● ● ●	● ● ● ● ●	● ● ● ● ●	● ● ● ● ●	● ● ● ● ●	● ● ● ● ●	● ● ● ● ●
H Hard materials	● ● ● ● ● *	● ● ● ● ●	● ● ● ● ●	● ● ● ● ●	● ● ● ● ●	● ● ● ● ●	● ● ● ● ●	● ● ● ● ●	● ● ● ● ●	● ● ● ● ●	● ● ● ● ●	● ● ● ● ●	● ● ● ● ●	● ● ● ● ●	● ● ● ● ●	● ● ● ● ●	● ● ● ● ●	● ● ● ● ●	● ● ● ● ●	● ● ● ● ●

Negative

Application	Chipbreaker	Designation		Corner radius	Coated							Coated cermet	Cermet										
		Inch	Metric		T9105	T9115	T9125	T9135	AH110	AH120	AH725	GT9530	NS9530										
Medium cutting		TM	WNMG 331E-TM	WNMG060404E-TM	0.016"	●	●																
			WNMG 332E-TM	WNMG060408E-TM	0.031"		●	●															
			WNMG 333E-TM	WNMG060412E-TM	0.047"		●	●															
			WNMG 331 TM	WNMG060404-TM	0.016"		●	●	●														
			WNMG 332 TM	WNMG060408-TM	0.031"	●	●	●	●		●												
			WNMG 431 TM	WNMG080404-TM	0.016"	●	●	●	●	●	●	●											
			WNMG 432 TM	WNMG080408-TM	0.031"	●	●	●	●	●	●	●											
			WNMG 433 TM	WNMG080412-TM	0.047"	●	●	●	●	●	●	●											
			WNMG 434 TM	WNMG080416-TM	0.063"	●	●	●			●												
Medium cutting		AM	WNMG 432 AM	WNMG080408-AM	0.031"		●	●															
			WNMG 433 AM	WNMG080412-AM	0.047"		●	●															
			WNMG 434 AM	WNMG080416-AM	0.063"		●	●															
Finishing to medium cutting		NM	WNMG 333E-NM	WNMG060412E-NM	0.047"			●															
			WNMG 432 NM	WNMG080408-NM	0.031"	●	●	●															
			WNMG 433 NM	WNMG080412-NM	0.047"	●	●	●	●														
Finishing to medium cutting		TQ	WNMG 431 TQ	WNMG080404-TQ	0.016"							●		●									
			WNMG 432 TQ	WNMG080408-TQ	0.031"								●		●								
Finishing to medium cutting		ZM	WNMG 332E-ZM	WNMG060408E-ZM	0.031"		●	●															
			WNMG 332 ZM	WNMG060408-ZM	0.031"		●	●	●														
			WNMG 333 ZM	WNMG060412-ZM	0.047"		●	●	●														
			WNMG 432 ZM	WNMG080408-ZM	0.031"		●	●	●				●		●								
			WNMG 433 ZM	WNMG080412-ZM	0.047"		●	●	●														
			WNMG 434 ZM	WNMG080416-ZM	0.063"		●	●															

● : Line up

Reference pages

External toolholders → B202 - Internal toolholders → B295 -
TungCap → B224, F009 -

TurnLine - Insert

● : Continuous cutting
 ● : Light interrupted cutting
 * : Heavy interrupted cutting

NEGATIVE TYPE



**Trigon, 80°
with hole**

	P	M	K	N	S	H
Steel	● ● ● ● *					
Stainless		● ● ● ●				
Cast iron	● ● ● ●		● ● ● ● *			
Non-ferrous				● ● ● ●		
Superalloys					● ●	
Hard materials						● ● ● ●

Application	Chipbreaker	Designation		Corner radius	Coated									Coated cermet	Cermet		Un-coated		
		Inch	Metric		T9105	T9115	T9125	T9135	T515	T5105	T5115	T5125	AH110	AH120	GH330	GT720	NS9530	NS520	TH10
Medium cutting		DM	WNMG 432 DM	WNMG080408-DM	0.031"	● ● ● ● *													
			WNMG 433 DM	WNMG080412-DM	0.047"	● ● ● ●													
		All-round	WNMG 331	WNMG060404	0.016"	● ●				● ● ●									
			WNMG 332	WNMG060408	0.031"	● ●				● ● ●									
			WNMG 431	WNMG080404	0.016"	● ● ● ●	● ● ● ●	● ● ● ●	● ● ● ●	● ● ● ●	● ● ● ●	● ● ● ●	● ● ● ●			● ●			● ●
			WNMG 432	WNMG080408	0.031"	● ● ● ●	● ● ● ●	● ● ● ●	● ● ● ●	● ● ● ●	● ● ● ●	● ● ● ●	● ● ● ●			● ●	● ●		● ●
			WNMG 433	WNMG080412	0.047"	● ● ● ●	● ● ● ●	● ● ● ●	● ● ● ●	● ● ● ●	● ● ● ●	● ● ● ●	● ● ● ●						● ●
			WNMG 434	WNMG080416	0.063"	● ● ● ●	● ● ● ●	● ● ● ●	● ● ● ●	● ● ● ●	● ● ● ●	● ● ● ●	● ● ● ●						
Finishing to medium cutting		27	WNMG 432 TN27	WNMG080408-27	0.031"	● ●													
Medium cutting		33	WNMG 431 TN33	WNMG080404-33	0.016"									●					
			WNMG 432 TN33	WNMG080408-33	0.031"	●													●
			WNMG 433 TN33	WNMG080412-33	0.047"	●													
		37	WNMG 431 TN37	WNMG080404-37	0.016"											●			
			WNMG 432 TN37	WNMG080408-37	0.031"	●							●			●			

● : Line up



Insert

Negative



Reference pages

External toolholders → B202 - Internal toolholders → B295 -
 TungCap → B224, F009 -



Insert

Negative

TurnLine - Insert

● : Continuous cutting
◐ : Light interrupted cutting
✱ : Heavy interrupted cutting

NEGATIVE TYPE



**Trigon, 80°
with hole**

	P	M	K	N	S	H	Steel	Stainless	Cast iron	Non-ferrous	Superalloys	Hard materials
●	●	●	●	●	●	●	●	●	●	●	●	●
◐	◐	◐	◐	◐	◐	◐	◐	◐	◐	◐	◐	◐
✱	✱	✱	✱	✱	✱	✱	✱	✱	✱	✱	✱	✱

Application	Chipbreaker	Designation		Corner radius	Coated											Uncoated												
		Inch	Metric		T6120	T6130	AH630	AH645	T515	T5105	T5115	T5125	AH110	AH120	AH725	AH8005	AH8015	AH905	KS20									
Medium cutting		SM	WNUMG 331E-SM	WNUMG060404E-SM	0.016"	●	●	●							●	●	●											
			WNUMG 332E-SM	WNUMG060408E-SM	0.031"	●	●	●																				
			WNUMG 333E-SM	WNUMG060412E-SM	0.047"	●	●	●																				
			WNUMG 332 SM	WNUMG060408-SM	0.031"													●										
			WNUMG 431 SM	WNUMG080404-SM	0.016"	●	●	●	●																			
			WNUMG 432 SM	WNUMG080408-SM	0.031"	●	●	●	●									●										
			WNUMG 433 SM	WNUMG080412-SM	0.047"	●	●	●	●									●										
Medium cutting		CM	WNUMG 431 CM	WNUMG080404-CM	0.016"										●													
			WNUMG 432 CM	WNUMG080408-CM	0.031"					●	●	●	●															
			WNUMG 433 CM	WNUMG080412-CM	0.047"					●	●	●	●															
Finishing to medium cutting		HRM	WNUMG 431 HRM	WNUMG080404-HRM	0.016"													●	●									
			WNUMG 432 HRM	WNUMG080408-HRM	0.031"															●	●							
			WNUMG 433 HRM	WNUMG080412-HRM	0.047"																●	●						
Medium cutting		HMM	WNUMG 431 HMM	WNUMG080404-HMM	0.016"																			●				
			WNUMG 432 HMM	WNUMG080408-HMM	0.031"																				●			
			WNUMG 433 HMM	WNUMG080412-HMM	0.047"																					●		
			WNUMG 432 SA	WNUMG080408-SA	0.031"	●	●	●	●								●	●	●							●		
Medium cutting		SA	WNUMG 433 SA	WNUMG080412-SA	0.047"	●	●	●	●							●												

● : Line up

Reference pages

External toolholders → B202 - Internal toolholders → B295 -
TungCap → B224, F009 -

TurnLine - Insert

● : Continuous cutting
 ● : Light interrupted cutting
 * : Heavy interrupted cutting

NEGATIVE TYPE



**Trigon, 80°
with hole**

	P	M	K	N	S	H
Steel	●●●●●●●●					
Stainless		●●●●●●●●				
Cast iron	●●●●●●●●		●●●●●●●●			
Non-ferrous				●●●●●●●●		
Superalloys					●●●●●●●●	
Hard materials						●●●●●●●●

Application	Chipbreaker	Designation		Corner radius	Coated								Cermet	Un-coated	Ceramics				
		Inch	Metric		T9105	T9115	T9125	T9135	T6130	AH630	AH645	T515				T5105	T5115	T5125	AH120
					NS520	FX105	TH10	LX11											
Medium to heavy cutting		TH	WNMG 432 TH	WNMG080408-TH	0.031"	●	●	●	●	●									
			WNMG 433 TH	WNMG080412-TH	0.047"	●	●	●	●										
			WNMG 434 TH	WNMG080416-TH	0.063"	●	●	●											
			WNMG 543 TH	WNMG100612-TH	0.047"	●	●	●											
			WNMG 544 TH	WNMG100616-TH	0.063"		●	●											
		THS	WNMG 432 THS	WNMG080408-THS	0.031"	●	●	●	●										
			WNMG 433 THS	WNMG080412-THS	0.047"	●	●	●	●										
			WNMG 434 THS	WNMG080416-THS	0.063"		●	●											
			WNMG 543 THS	WNMG100612-THS	0.047"		●	●	●	●									
			WNMG 544 THS	WNMG100616-THS	0.063"		●	●	●										
Medium to heavy cutting		SH	WNMG 432 SH	WNMG080408-SH	0.031"					●	●	●							
			WNMG 433 SH	WNMG080412-SH	0.047"					●	●	●							
		CH	WNMG 432 CH	WNMG080408-CH	0.031"							●	●	●					
			WNMG 433 CH	WNMG080412-CH	0.047"							●	●	●					
Finishing to medium cutting		-	WNMA 431	WNMA080404	0.016"							●	●	●			●		
			WNMA 432	WNMA080408	0.031"	●					●	●	●	●			●		
			WNMA 433	WNMA080412	0.047"	●					●	●	●	●			●		
			WNMA 434	WNMA080416	0.063"						●	●	●	●					
			WNGA 431	WNGA080404	0.016"														●
			WNGA 432	WNGA080408	0.031"														●
			WNGA 433	WNGA080412	0.047"														●

● : Line up

Reference pages

External toolholders → B210 - Internal toolholders → B322 -
 TungCap → B224, F009 -





Insert

Negative

TurnLine - Insert

● : Continuous cutting
 ●c : Light interrupted cutting
 * : Heavy interrupted cutting

NEGATIVE TYPE

P	Steel	●*	●*			●c			●c										
M	Stainless																		
K	Cast iron					●c			●c										
N	Non-ferrous																		
S	Superalloys																		
H	Hard materials																		

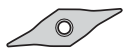

Rhombic, 25° with hole

Application	Chipbreaker	Designation		Corner radius	Coated		Coated cermet		Cermet										
		Inch	Metric		T9125	T9135	GT9530	NS9530											
Finishing		ZF	YNMG 331 ZF	YNMG160404-ZF	0.016"	●	●		●		●								
			YNMG 332 ZF	YNMG160408-ZF	0.031"	●	●		●		●								
Finishing to medium cutting		ZM	YNMG 331 ZM	YNMG160404-ZM	0.016"	●	●		●		●								
			YNMG 332 ZM	YNMG160408-ZM	0.031"	●	●		●		●								

● : Line up

Reference pages

YNMG... : External toolholders → B211 -, B217, Internal toolholders → B325, B328
 TungCap → B224



TurnLine - Insert

● : Continuous cutting
 ●● : Light interrupted cutting
 ●* : Heavy interrupted cutting



Insert

Negative

NEGATIVE TYPE

 Parallelogram, 55° without hole

P	M	K	N	S	H
Steel	Stainless	Cast iron	Non-ferrous	Superalloys	Hard materials

Application	Chipbreaker	Designation		Corner radius	Coated																
		Inch	Metric		GH330																
Finishing		-	KNMX160405R-S1	0.020"	●●																
		-	KNMX160405L-S1	0.020"	●●																

 Hexagon, 120° without hole

P	M	K	N	S	H
Steel	Stainless	Cast iron	Non-ferrous	Superalloys	Hard materials

Application	Chipbreaker	Designation		Corner radius	Ceramics																	
		Inch	Metric		FX105																	
Finishing to medium cutting		-	HNGD 453	HNGD050712	0.047"	●																
		-	HNGD 454	HNGD050716	0.063"	●																

● : Line up

OTHERS

Reference pages

KNMX... : External toolholders → **B256**

HNGD... : External toolholders → **B273**



Insert

TurnLine - Insert

● : Continuous cutting
 ● : Light interrupted cutting
 * : Heavy interrupted cutting

POSITIVE TYPE



**Rhombic, 80°
with hole
Positive 7°**

P	Steel	●	●	●	*	●	●	●	●	●	●	●	●	●	●	●	●	●	●	●	●
M	Stainless	●	●	●	●	●	●	●	●	●	●	●	●	●	●	●	●	●	●	●	●
K	Cast iron	●	●	●	●	●	●	●	●	●	●	●	●	●	●	●	●	●	●	●	●
N	Non-ferrous																				
S	Superalloys					●	●	●	●	●											
H	Hard materials																				

Application	Chipbreaker	Designation		Corner radius	Coated											Coated cermet	Cermet						
		Inch	Metric		T9115	T9125	T6120	T6130	AH110	AH120	AH725	AH8005	AH8015	GH730	SH725	J740	GT9530	NS9530					
Precision finishing		01	CCGT 21.50.5-01	CCGT060202-01	0.008"																		
			CCGT 32.50.5-01	CCGT09T302-01	0.008"																		
Precision finishing (Sharp edge)		01	CCGT 21.50.5 F-01	CCGT060202F-01	0.008"									●									
			CCGT 21.51 F-01	CCGT060204F-01	0.016"									●									
			CCGT 32.50.5 F-01	CCGT09T302F-01	0.008"										●								
Finishing		PSF	CCMT 21.50.5 PSF	CCMT060202-PSF	0.008"													●		●			
			CCMT 21.51 PSF	CCMT060204-PSF	0.016"	●	●					●	●	●					●		●		
			CCMT 32.50.5 PSF	CCMT09T302-PSF	0.008"							●									●		
			CCMT 32.51 PSF	CCMT09T304-PSF	0.016"	●	●					●	●	●						●		●	
			CCMT 32.52 PSF	CCMT09T308-PSF	0.031"	●	●					●									●		●
	PF	CCMT 21.50.5 PF	CCMT060202-PF	0.008"		●													●		●		
		CCMT 21.51 PF	CCMT060204-PF	0.016"	●	●	●	●	●	●									●		●		
		CCMT 21.52 PF	CCMT060208-PF	0.031"		●														●		●	
	CCMT 32.50.5 PF	CCMT09T302-PF	0.008"		●														●		●		
	CCMT 32.51 PF	CCMT09T304-PF	0.016"		●	●	●	●	●										●		●		
	CCMT 32.52 PF	CCMT09T308-PF	0.031"		●					●									●		●		

● : Line up

Reference pages

External toolholders → B261 Internal toolholders → B299 -, B330
 J series toolholders → B362 - B365

TurnLine - Insert

● : Continuous cutting
 ● : Light interrupted cutting
 * : Heavy interrupted cutting

POSITIVE TYPE



**Rhombic, 80°
with hole
Positive 7°**

	P	M	K	N	S	H
Steel	●●●*	●	●	●	●	●
Stainless	●	●●●*	●	●	●	●
Cast iron	●●	●	●●●*	●	●	●
Non-ferrous	●	●	●	●●●*	●	●
Superalloys	●	●	●	●	●●●*	●
Hard materials	●	●	●	●	●	●●●*

Application	Chipbreaker	Designation		Corner radius	Coated										Coated cermet	Cermet						
		Inch	Metric		T9115	T9125	T6120	T6130	AH630	AH645	AH120	AH725	AH8005	AH8015	GH730	GT9530	NS9530					
Finishing to light cutting		PSS	CCMT 21.51 PSS	CCMT060204-PSS	0.016"	●	●	●	●	●	●	●	●	●	●	●	●	●	●	●		
			CCMT 21.52 PSS	CCMT060208-PSS	0.031"	●	●	●	●	●	●	●	●	●	●	●	●	●	●	●	●	
			CCMT 32.51 PSS	CCMT09T304-PSS	0.016"	●	●	●	●	●	●	●	●	●	●	●	●	●	●	●	●	
			CCMT 32.52 PSS	CCMT09T308-PSS	0.031"	●	●	●	●	●	●	●	●	●	●	●	●	●	●	●	●	
			CCMT 431 PSS	CCMT120404-PSS	0.016"	●	●	●	●	●	●	●	●	●	●	●	●	●	●	●	●	
			CCMT 432 PSS	CCMT120408-PSS	0.031"	●	●	●	●	●	●	●	●	●	●	●	●	●	●	●	●	
			CCMT 433 PSS	CCMT120412-PSS	0.047"	●	●	●	●	●	●	●	●	●	●	●	●	●	●	●	●	
Finishing to medium cutting		PS	CCMT 21.50.5 PS	CCMT060202-PS	0.008"	●	●	●	●	●	●	●	●	●	●	●	●	●	●	●		
			CCMT 21.51 PS	CCMT060204-PS	0.016"	●	●	●	●	●	●	●	●	●	●	●	●	●	●	●	●	
			CCMT 21.52 PS	CCMT060208-PS	0.031"	●	●	●	●	●	●	●	●	●	●	●	●	●	●	●	●	
			CCMT 32.50.5 PS	CCMT09T302-PS	0.008"	●	●	●	●	●	●	●	●	●	●	●	●	●	●	●	●	
			CCMT 32.51 PS	CCMT09T304-PS	0.016"	●	●	●	●	●	●	●	●	●	●	●	●	●	●	●	●	
			CCMT 32.52 PS	CCMT09T308-PS	0.031"	●	●	●	●	●	●	●	●	●	●	●	●	●	●	●	●	
			CCMT 431 PS	CCMT120404-PS	0.016"	●	●	●	●	●	●	●	●	●	●	●	●	●	●	●	●	
			CCMT 432 PS	CCMT120408-PS	0.031"	●	●	●	●	●	●	●	●	●	●	●	●	●	●	●	●	
Finishing to medium cutting Wiper		SW	CCMT 21.51-SW	CCMT060204-SW	0.016"	●	●												●	●		
			CCMT 21.52-SW	CCMT060208-SW	0.031"	●	●													●	●	
			CCMT 32.51-SW	CCMT09T304-SW	0.016"	●	●													●	●	
			CCMT 32.52-SW	CCMT09T308-SW	0.031"	●	●													●	●	
		Medium cutting		24	CCMT 21.50.5-24	CCMT060202-24	0.008"	●	●												●	●
	CCMT 21.51-24			CCMT060204-24	0.016"	●	●	●				●								●	●	
	CCMT 21.52-24			CCMT060208-24	0.031"	●	●	●				●									●	●
	CCMT 32.50.5-24			CCMT09T302-24	0.008"	●	●														●	●
	CCMT 32.51-24			CCMT09T304-24	0.016"	●	●	●				●									●	●
	CCMT 32.52-24			CCMT09T308-24	0.031"	●	●	●				●									●	●
	CCMT 432-24			CCMT120408-24	0.031"	●	●	●				●									●	●

● : Line up

Reference pages

External toolholders → B261

Internal toolholders → B299 -, B330

J series toolholders → B362 - B365



Insert

Positive

C



Insert

TurnLine - Insert

● : Continuous cutting
● : Light interrupted cutting
* : Heavy interrupted cutting

POSITIVE TYPE



**Rhombic, 80°
with hole
Positive 7°**

Material	SH725	SH730	TH10	Other
P Steel	●	●	●	●
M Stainless	●	●	●	●
K Cast iron	●	●	●	●
N Non-ferrous	●	●	●	●
S Superalloys	●	●	●	●
H Hard materials	●	●	●	●

Application	Chipbreaker	Designation		Corner radius	Coated		Uncoated			
		Inch	Metric		SH725	SH730	TH10			
Finishing		W08	CCGT 4.51.8V R-W08	CCGT03X100R-W08	0.0012"	●	●	●		
			CCGT 4.51.8V L-W08	CCGT03X100L-W08	0.0012"	●	●	●		
			CCGT 4.51.80 R-W08	CCGT03X101R-W08	0.004"	●	●	●		
			CCGT 4.51.80 L-W08	CCGT03X101L-W08	0.004"	●	●	●		
			CCGT 4.51.80.5 R-W08	CCGT03X102R-W08	0.008"	●	●	●		
			CCGT 4.51.80.5 L-W08	CCGT03X102L-W08	0.008"	●	●	●		
			CCGT 4.51.81 R-W08	CCGT03X104R-W08	0.016"	●	●	●		
			CCGT 4.51.81 L-W08	CCGT03X104L-W08	0.016"	●	●	●		
			CCGT 5.52.2V R-W08	CCGT04T100R-W08	0.0012"	●	●	●		
			CCGT 5.52.2V L-W08	CCGT04T100L-W08	0.0012"	●	●	●		
			CCGT 5.52.20 R-W08	CCGT04T101R-W08	0.004"	●	●	●		
			CCGT 5.52.20 L-W08	CCGT04T101L-W08	0.004"	●	●	●		
			CCGT 5.52.20.5 R-W08	CCGT04T102R-W08	0.008"	●	●	●		
			CCGT 5.52.20.5 L-W08	CCGT04T102L-W08	0.008"	●	●	●		
			CCGT 5.52.21 R-W08	CCGT04T104R-W08	0.016"	●	●	●		
			CCGT 5.52.21 L-W08	CCGT04T104L-W08	0.016"	●	●	●		
		Finishing (Sharp edge)		W08	CCGT 4.51.8V FL-W08	CCGT03X100FL-W08	0.0012"	●		
					CCGT 4.51.8V FR-W08	CCGT03X100FR-W08	0.0012"	●		
	CCGT 4.51.80 FL-W08			CCGT03X101FL-W08	0.004"	●				
	CCGT 4.51.80 FR-W08			CCGT03X101FR-W08	0.004"	●				
	CCGT 4.51.80.5 FL-W08			CCGT03X102FL-W08	0.008"	●				
	CCGT 4.51.80.5 FR-W08			CCGT03X102FR-W08	0.008"	●				
	CCGT 4.51.81 FL-W08			CCGT03X104FL-W08	0.016"	●				
	CCGT 4.51.81 FR-W08			CCGT03X104FR-W08	0.016"	●				
	CCGT 5.52.2V FL-W08			CCGT04T100FL-W08	0.0012"	●				
	CCGT 5.52.2V FR-W08			CCGT04T100FR-W08	0.0012"	●				
	CCGT 5.52.20 FL-W08			CCGT04T101FL-W08	0.004"	●				
	CCGT 5.52.20 FR-W08			CCGT04T101FR-W08	0.004"	●				
	CCGT 5.52.20.5 FL-W08			CCGT04T102FL-W08	0.008"	●				
	CCGT 5.52.20.5 FR-W08			CCGT04T102FR-W08	0.008"	●				
	CCGT 5.52.21 FL-W08			CCGT04T104FL-W08	0.016"	●				
	CCGT 5.52.21 FR-W08			CCGT04T104FR-W08	0.016"	●				

● : Line up

Reference pages

Internal toolholders → B299 -

TurnLine - Insert

● : Continuous cutting
 ● : Light interrupted cutting
 * : Heavy interrupted cutting

POSITIVE TYPE

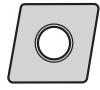

**Rhombic, 80°
with hole
Positive 7°**

	P	M	K	N	S	H
Steel	●●●*	●	●	●	●	●
Stainless	●	●	●	●	●	●
Cast iron	●●	●	●	●	●	●
Non-ferrous				●		
Superalloys					●	
Hard materials						●

Application	Chipbreaker	Designation		Corner radius	Coated										Coated cermet	Cermet	Uncoated							
		Inch	Metric		T9115	T9125	T6120	T6130	AH630	AH645	T515	T5115	AH110	AH120	AH725	GH110	GH330	GH730	GT9530	NS9530	TH10	UX30		
Finishing		W15	CCGT 21.5VR-W15	CCGT060200R-W15	0.0012"																			
			CCGT 21.5VL-W15	CCGT060200L-W15	0.0012"															●	●			
			CCGT 21.50.5R-W15	CCGT060202R-W15	0.008"															●	●	●		
			CCGT 21.50.5L-W15	CCGT060202L-W15	0.008"														●	●	●	●		
			CCGT 21.51R-W15	CCGT060204R-W15	0.016"																●	●	●	
			CCGT 21.51L-W15	CCGT060204L-W15	0.016"															●	●	●	●	
		W20	CCGT32.50.5R-W20	CCGT09T302R-W20	0.008"															●	●	●		
			CCGT32.50.5L-W20	CCGT09T302L-W20	0.008"															●	●	●		
			CCGT32.51R-W20	CCGT09T304R-W20	0.016"																●	●	●	
			CCGT32.51L-W20	CCGT09T304L-W20	0.016"															●	●	●	●	
			CCGT32.52R-W20	CCGT09T308R-W20	0.031"																●	●	●	
			CCGT32.52L-W20	CCGT09T308L-W20	0.031"															●	●	●	●	
Medium cutting		PM	CCMT 21.51 PM	CCMT060204-PM	0.016"	●	●	●	●	●	●			●	●	●		●	●	●				
			CCMT 21.52 PM	CCMT060208-PM	0.031"	●	●	●	●	●	●			●	●	●		●	●	●				
			CCMT 32.51 PM	CCMT09T304-PM	0.016"	●	●	●	●	●	●			●	●	●		●	●	●				
			CCMT 32.52 PM	CCMT09T308-PM	0.031"	●	●	●	●	●	●			●	●	●		●	●	●				
			CCMT 32.53 PM	CCMT09T312-PM	0.047"	●	●	●	●	●	●			●	●	●		●	●	●				
			CCMT 432 PM	CCMT120408-PM	0.031"			●	●	●	●					●	●			●	●	●		
			CCMT 433 PM	CCMT120412-PM	0.047"			●	●	●	●					●	●			●	●	●		
Finishing to medium cutting		CM	CCMT 21.51 CM	CCMT060204-CM	0.016"																			
			CCMT 21.52 CM	CCMT060208-CM	0.031"																			
			CCMT 32.51 CM	CCMT09T304-CM	0.016"																			
			CCMT 32.52 CM	CCMT09T308-CM	0.031"																			
			CCMT 32.53 CM	CCMT09T312-CM	0.047"																			
			CCMT 431 CM	CCMT120404-CM	0.016"																			
			CCMT 432 CM	CCMT120408-CM	0.031"																			

● : Line up

Reference pages

External toolholders → **B261** Internal toolholders → **B299 -, B330**
 J series toolholders → **B362 - B365**

Insert

Positive

C



Insert

TurnLine - Insert

● : Continuous cutting
 ●c : Light interrupted cutting
 * : Heavy interrupted cutting

POSITIVE TYPE



**Rhombic, 80°
 with hole
 Positive 7°**

Material	Steel	Stainless	Cast iron	Non-ferrous	Superalloys	Hard materials	Coated	Cermet	Uncoated
P	●	●c	●c	●			●		
M	●	●c	●c	●			●		
K	●c	●	●c	●			●		
N				●			●		
S					●		●		
H						●			

Positive

C

Application	Chipbreaker	Designation		Corner radius	Coated			Cermet	Uncoated	
		Inch	Metric		T5115	GH110	SH725	NS9530	TH10	KS05F
 Finishing to medium cutting	AL	CCGT 21.50 AL	CCGT060201-AL	0.004"			●			
		CCGT 21.50.5 AL	CCGT060202-AL	0.008"			●			
		CCGT 21.51 AL	CCGT060204-AL	0.016"						●
		CCGT 32.50 AL	CCGT09T301-AL	0.004"						●
		CCGT 32.50.5 AL	CCGT09T302-AL	0.008"			●			●
		CCGT 32.51 AL	CCGT09T304-AL	0.016"			●			●
		CCGT 32.52 AL	CCGT09T308-AL	0.031"						●
		CCGT 430.5 AL	CCGT120402-AL	0.008"						●
		CCGT 431 AL	CCGT120404-AL	0.016"						●
		CCGT 432 AL	CCGT120408-AL	0.031"						●
 Finishing to medium cutting	All-round	CCGT 21.50.5	CCGT060202	0.008"				●		
		CCGT 21.51	CCGT060204	0.016"					●	
		CCGT 32.50.5	CCGT09T302	0.008"					●	
		CCGT 32.51	CCGT09T304	0.016"					●	
		CCGT 32.52	CCGT09T308	0.031"					●	
 Finishing to medium cutting	Angular	CCGT 21.5 R	CCGT060200R	0.0012"					●	
		CCGT 21.50.5 R	CCGT060202R	0.008"					●	
		CCGT 21.50.5 L	CCGT060202L	0.008"					●	
		CCGT 21.51 L	CCGT060204L	0.016"					●	
		CCGT 32.50.5 R	CCGT09T302R	0.008"					●	
		CCGT 32.50.5 L	CCGT09T302L	0.008"					●	
		CCGT 32.51 R	CCGT09T304R	0.016"					●	
		CCGT 32.51 L	CCGT09T304L	0.016"					●	
 Finishing to medium cutting	-	CCMW 21.51	CCMW060204	0.016"	●					
		CCMW 21.52	CCMW060208	0.031"	●					
		CCMW 32.51	CCMW09T304	0.016"	●					
		CCMW 32.52	CCMW09T308	0.031"	●					
 Finishing to medium cutting	-	CCGW 21.50.5	CCGW060202	0.008"				●		
		CCGW 21.51	CCGW060204	0.016"					●	
		CCGW 32.51	CCGW09T304	0.016"		●			●	

● : Line up

Reference pages

External toolholders → B261 Internal toolholders → B299 -, B330
 J series toolholders → B362 - B365

- : Continuous cutting
- ◐ : Light interrupted cutting
- * : Heavy interrupted cutting



Insert

TurnLine - Insert

POSITIVE TYPE



**Rhombic, 80°
with hole
Positive 7°**

P Steel	●●●●			●●		●													
M Stainless	●●●●					●													
K Cast iron						●●		●											
N Non-ferrous											●								
S Superalloys																			
H Hard materials																			

Positive

Application	Chipbreaker	Designation		Corner radius	Coated		Cermet	Uncoated																
		Inch	Metric		SH725 J740	NS9530	TH10																	
For external turning on small lathes (Sharp edge)		J10	CCGT 21.5V FR-J10	CCGT060200FR-J10	0.0012"	●	●		●															
			CCGT 21.5V FL-J10	CCGT060200FL-J10	0.0012"	●	●		●															
			CCGT 21.50 FR-J10	CCGT060201FR-J10	0.004"	●	●		●															
			CCGT 21.50 FL-J10	CCGT060201FL-J10	0.004"	●	●		●															
			CCGT 21.50.5 FR-J10	CCGT060202FR-J10	0.008"	●	●		●															
			CCGT 21.50.5 FL-J10	CCGT060202FL-J10	0.008"	●	●		●															
			CCGT 32.5V FR-J10	CCGT09T300FR-J10	0.0012"	●	●			●														
			CCGT 32.5V FL-J10	CCGT09T300FL-J10	0.0012"	●	●			●														
			CCGT 32.50 FR-J10	CCGT09T301FR-J10	0.004"	●	●			●														
			CCGT 32.50 FL-J10	CCGT09T301FL-J10	0.004"	●	●			●														
			CCGT 32.50.5 FR-J10	CCGT09T302FR-J10	0.008"	●	●			●														
			CCGT 32.50.5 FL-J10	CCGT09T302FL-J10	0.008"	●	●			●														
			CCGT 32.51 FR-J10	CCGT09T304FR-J10	0.016"	●																		

● : Line up

C

Reference pages

External toolholders → **B261** Internal toolholders → **B299 -, B330**
 J series toolholders → **B362 - B365**

TurnLine - Insert

● : Continuous cutting
 ● : Light interrupted cutting
 * : Heavy interrupted cutting

POSITIVE TYPE



**Rhombic, 80°
with hole
Positive 11°**

	P	M	K	N	S	H														
Steel	●●●*	●	●	●	●	●	●	●	●	●	●	●	●	●	●	●	●	●	●	●
Stainless	●	●	●	●	●	●	●	●	●	●	●	●	●	●	●	●	●	●	●	●
Cast iron	●●	●	●	●	●	●	●	●	●	●	●	●	●	●	●	●	●	●	●	●
Non-ferrous	●	●	●	●	●	●	●	●	●	●	●	●	●	●	●	●	●	●	●	●
Superalloys	●	●	●	●	●	●	●	●	●	●	●	●	●	●	●	●	●	●	●	●
Hard materials	●	●	●	●	●	●	●	●	●	●	●	●	●	●	●	●	●	●	●	●

Application	Chipbreaker	Designation		Corner radius	Coated								Coated cermet	Cermet									
		Inch	Metric		T9115	T9125	T6120	T6130	AH630	AH645	AH120	AH725	GH730	GT9530	NS9530								
Finishing		PSF	CPMT21.50.5 PSF	CPMT060202-PSF	0.008"																		
			CPMT 21.51 PSF	CPMT060204-PSF	0.016"	●	●																
			CPMT 2.51.50.5 PSF	CPMT080202-PSF	0.008"																		
			CPMT 2.51.51 PSF	CPMT080204-PSF	0.016"	●	●																
			CPMT 321 PSF	CPMT090302-PSF	0.008"										●								
			CPMT 322 PSF	CPMT090304-PSF	0.016"	●	●								●								
			CPMT 32.50.5 PSF	CPMT09T302-PSF	0.008"										●								
			CPMT 32.51 PSF	CPMT09T304-PSF	0.016"	●	●								●								
		PF	CPMT 320.5 PF	CPMT090302-PF	0.008"										●								
		CPMT 321 PF	CPMT090304-PF	0.016"										●									
Finishing to light cutting		PSS	CPMT 21.51 PSS	CPMT060204-PSS	0.016"	●	●							●									
			CPMT 2.51.51 PSS	CPMT080204-PSS	0.016"	●	●	●	●	●	●				●								
			CPMT 2.51.52 PSS	CPMT080208-PSS	0.031"	●	●	●	●	●	●				●								
			CPMT 321 PSS	CPMT090304-PSS	0.016"	●	●	●	●	●	●				●								
			CPMT 322 PSS	CPMT090308-PSS	0.031"	●	●	●	●	●	●				●								
			CPMT 32.51 PSS	CPMT09T304-PSS	0.016"	●	●								●								
			CPMT 32.52 PSS	CPMT09T308-PSS	0.031"	●	●								●								
Finishing to medium cutting		PS	CPMT 21.50.5 PS	CPMT060202-PS	0.008"	●	●																
			CPMT 21.51 PS	CPMT060204-PS	0.016"	●	●								●								
			CPMT 2.51.50.5 PS	CPMT080202-PS	0.008"	●	●	●	●	●	●				●								
			CPMT 2.51.51 PS	CPMT080204-PS	0.016"	●	●	●	●	●	●				●								
			CPMT 2.51.52 PS	CPMT080208-PS	0.031"	●	●	●	●	●	●				●								
			CPMT 321 PS	CPMT090304-PS	0.016"	●	●	●	●	●	●				●								
			CPMT 322 PS	CPMT090308-PS	0.031"	●	●	●	●	●	●				●								
			CPMT 32.50.5 PS	CPMT09T302-PS	0.008"	●	●								●								
			CPMT 32.51 PS	CPMT09T304-PS	0.016"	●	●								●								
			CPMT 32.52 PS	CPMT09T308-PS	0.031"	●	●								●								

● : Line up

Reference pages

Internal toolholders → B303 -, B330



Insert

Positive

C



Insert

TurnLine - Insert

● : Continuous cutting
 ● : Light interrupted cutting
 ✱ : Heavy interrupted cutting

POSITIVE TYPE



Rhombic, 80° with hole Positive 11°

Material	P Steel	M Stainless	K Cast iron	N Non-ferrous	S Superalloys	H Hard materials	Coated	Cermet	Uncoated
C ✱			●						
●	●								
●		●							
●			●						
●				●					

Application	Chipbreaker	Designation		Corner radius	Coated		Cermet		Uncoated		
		Inch	Metric		T9125	NS9530	TH10				
Medium cutting		24	CPMT 432-24	CPMT120408-24	0.031"		●				
			CPMT 53.52-24	CPMT160508-24	0.031"	●	●				
			CPMT 53.53-24	CPMT160512-24	0.047"		●				
Finishing		W15	CPGT 730.5FL-W15	CPGT050202L-W15	0.008"		●				
			CPGT 731FL-W15	CPGT050204L-W15	0.016"		●				
			CPGT 2.51.50.5FR-W15	CPGT080202R-W15	0.008"			●			
			CPGT 2.51.50.5FL-W15	CPGT080202L-W15	0.008"		●	●			
			CPGT 2.51.51FR-W15	CPGT080204R-W15	0.016"			●			
			CPGT 2.51.51FL-W15	CPGT080204L-W15	0.016"		●	●			
			W20	CPMW 320.5R W20	CPGT090302R-W20	0.008"		●	●		
			CPMW 320.5L W20	CPGT090302L-W20	0.008"		●	●			
		CPMW 321R W20	CPGT090304R-W20	0.016"		●	●				
		CPMW 321L W20	CPGT090304L-W20	0.016"		●	●				

Positive

C

● : Line up

Reference pages

Internal toolholders → B303 -, B330

TurnLine - Insert

● : Continuous cutting
 ● : Light interrupted cutting
 ✱ : Heavy interrupted cutting

POSITIVE TYPE



Rhombic, 80°
 with hole
 Positive 11°

P	Steel	●	●	✱	✱	✱	✱	✱	✱	✱	✱	✱	✱	✱	✱	✱	✱	✱	✱	✱	✱	✱	✱	✱	✱	✱	✱	✱	✱	✱	✱	✱	✱	✱	✱	✱	✱		
M	Stainless		●	●	●	●	●	●	●	●	●	●	●	●	●	●	●	●	●	●	●	●	●	●	●	●	●	●	●	●	●	●	●	●	●	●	●	●	
K	Cast iron	●	●	●	●	●	●	●	●	●	●	●	●	●	●	●	●	●	●	●	●	●	●	●	●	●	●	●	●	●	●	●	●	●	●	●	●	●	●
N	Non-ferrous																																						
S	Superalloys																																						
H	Hard materials																																						

Application	Chipbreaker	Designation Inch Metric		Corner radius	Coated										Cermet																								
					T9105	T9125	T6120	T6130	AH630	AH645	T515	T5115	AH725	AH8005	AH8015	AH905		NS9530																					
Medium cutting		PM	CPMT 21.51 PM CPMT060204-PM	0.016"			●	●	●	●																													
			CPMT 21.52 PM CPMT060208-PM	0.031"		●	●	●	●	●			●																										
			CPMT 321 PM CPMT090304-PM	0.016"		●	●	●	●	●			●																										
			CPMT 322 PM CPMT090308-PM	0.031"		●	●	●	●	●			●																										
Finishing to medium cutting		CM	CPMT 21.51 CM CPMT060204-CM	0.016"																																			
			CPMT 21.52 CM CPMT060208-CM	0.031"																																			
			CPMT 2.51.51 CM CPMT080204-CM	0.016"																																			
			CPMT 2.51.52 CM CPMT080208-CM	0.031"																																			
			CPMT 321 CM CPMT090304-CM	0.016"																																			
			CPMT 322 CM CPMT090308-CM	0.031"																																			
			CPMT 32.51 CM CPMT09T304-CM	0.016"																																			
			CPMT 32.52 CM CPMT09T308-CM	0.031"																																			
			CPMT 32.53 CM CPMT09T312-CM	0.047"																																			
			CPMT 432 CM CPMT120408-CM	0.031"																																			
			CPMT 433 CM CPMT120412-CM	0.047"																																			
Medium cutting		All-round	CPMT 432 CPMT120408	0.031"																																			
			-	CPMW 2.51.51 CPMW080204	0.016"																																		
			-	CPMW 2.51.52 CPMW080208	0.031"																																		
			-	CPMW 321 CPMW090304	0.016"																																		
-	CPMW 322 CPMW090308	0.031"																																					

● : Line up

Reference pages
 Internal toolholders → B303 -, B330



Insert

Positive

C



Insert

TurnLine - Insert

● : Continuous cutting
 ● : Light interrupted cutting
 * : Heavy interrupted cutting

POSITIVE TYPE



Rhombic, 55°
with hole
Positive 7°

Material	Steel	Stainless	Cast iron	Non-ferrous	Superalloys	Hard materials	T9115	T9125	AH725	AH8005	AH8015	AH905	GH730	SH725	J740	GT9530	J9530	NS9530	
P	●●●*	●	●	●	●	●	●	●	●	●	●	●	●	●	●	●	●	●	●
M	●	●●●	●	●	●	●	●	●	●	●	●	●	●	●	●	●	●	●	●
K	●●	●	●	●	●	●	●	●	●	●	●	●	●	●	●	●	●	●	●
N	●	●	●	●	●	●	●	●	●	●	●	●	●	●	●	●	●	●	●
S	●	●	●	●	●	●	●	●	●	●	●	●	●	●	●	●	●	●	●
H	●	●	●	●	●	●	●	●	●	●	●	●	●	●	●	●	●	●	●

Application	Chipbreaker	Designation		Corner radius	Coated							Coated cermet		Cermet						
		Inch	Metric		T9115	T9125	AH725	AH8005	AH8015	AH905	GH730	SH725	J740	GT9530	J9530	NS9530				
Precision finishing		01	DCGT 21.50.5-01	DCGT070202-01	0.008"															
			DCGT 32.50.5-01	DCGT11T302-01	0.008"															
Precision finishing (Sharp edge)		01	DCGT 21.50.5 F-01	DCGT070202F-01	0.008"															
			DCGT 32.50.5 F-01	DCGT11T302F-01	0.008"															
Finishing		PSF	DCMT 21.50.5 PSF	DCMT070202-PSF	0.008"				●											
			DCMT 21.51 PSF	DCMT070204-PSF	0.016"	●	●	●												
			DCMT 32.50.5 PSF	DCMT11T302-PSF	0.008"				●											
			DCMT 32.51 PSF	DCMT11T304-PSF	0.016"	●	●	●	●	●	●									
			DCMT 32.52 PSF	DCMT11T308-PSF	0.031"	●	●	●	●	●	●									
		PF	DCMT 21.50.5 PF	DCMT070202-PF	0.008"															
			DCMT 21.51 PF	DCMT070204-PF	0.016"															
			DCMT 21.52 PF	DCMT070208-PF	0.031"															
	DCMT 32.50.5 PF	DCMT11T302-PF	0.008"																	
	DCMT 32.51 PF	DCMT11T304-PF	0.016"																	
	DCMT 32.52 PF	DCMT11T308-PF	0.031"																	

● : Line up

Reference pages

External toolholders → **B228** - Internal toolholders → **B313** -
 J series toolholders → **B365** - **B369**

TurnLine - Insert

● : Continuous cutting
 ● : Light interrupted cutting
 * : Heavy interrupted cutting

POSITIVE TYPE



Rhombic, 55°
 with hole
 Positive 7°

	P	M	K	N	S	H																
Steel	●●●*	●	●	●	●	●	●	●	●	●	●	●	●	●	●	●	●	●	●	●	●	●
Stainless	●	●●●	●	●	●	●	●	●	●	●	●	●	●	●	●	●	●	●	●	●	●	●
Cast iron	●●	●	●●●	●	●	●	●	●	●	●	●	●	●	●	●	●	●	●	●	●	●	●
Non-ferrous	●	●	●	●●●	●	●	●	●	●	●	●	●	●	●	●	●	●	●	●	●	●	●
Superalloys	●	●	●	●	●●●	●	●	●	●	●	●	●	●	●	●	●	●	●	●	●	●	●
Hard materials	●	●	●	●	●	●	●	●	●	●	●	●	●	●	●	●	●	●	●	●	●	●

Application	Chipbreaker	Designation		Corner radius	Coated										Coated cermet	Cermet								
		Inch	Metric		T9115	T9125	T6120	T6130	AH630	AH645	AH120	AH725	AH8005	AH8015	AH905	GH730	GT9530	NS9530						
Finishing to light cutting		PSS	DCMT 21.51 PSS	DCMT070204-PSS	0.016"	●	●	●	●	●	●	●	●	●	●	●	●	●	●	●	●	●	●	
			DCMT 21.52 PSS	DCMT070208-PSS	0.031"	●	●	●	●	●	●	●	●	●	●	●	●	●	●	●	●	●	●	●
			DCMT 32.51 PSS	DCMT11T304-PSS	0.016"	●	●	●	●	●	●	●	●	●	●	●	●	●	●	●	●	●	●	●
			DCMT 32.52 PSS	DCMT11T308-PSS	0.031"	●	●	●	●	●	●	●	●	●	●	●	●	●	●	●	●	●	●	●
			DCMT 32.53 PSS	DCMT11T312-PSS	0.047"	●	●	●	●	●	●	●	●	●	●	●	●	●	●	●	●	●	●	●
Finishing to medium cutting		PS	DCMT 21.50.5 PS	DCMT070202-PS	0.008"	●	●	●	●	●	●	●	●	●	●	●	●	●	●	●	●	●	●	
			DCMT 21.51 PS	DCMT070204-PS	0.016"	●	●	●	●	●	●	●	●	●	●	●	●	●	●	●	●	●	●	
			DCMT 21.52 PS	DCMT070208-PS	0.031"	●	●	●	●	●	●	●	●	●	●	●	●	●	●	●	●	●	●	
			DCMT 32.50.5 PS	DCMT11T302-PS	0.008"	●	●	●	●	●	●	●	●	●	●	●	●	●	●	●	●	●	●	●
			DCMT 32.51 PS	DCMT11T304-PS	0.016"	●	●	●	●	●	●	●	●	●	●	●	●	●	●	●	●	●	●	●
			DCMT 32.52 PS	DCMT11T308-PS	0.031"	●	●	●	●	●	●	●	●	●	●	●	●	●	●	●	●	●	●	●
			DCMT 32.53 PS	DCMT11T312-PS	0.047"	●	●	●	●	●	●	●	●	●	●	●	●	●	●	●	●	●	●	●
Finishing to medium cutting		23	DCMT 21.51-23	DCMT070204-23	0.016"																	●		
			DCMT 32.51 23	DCMT11T304-23	0.016"																		●	
			DCMT 32.52-23	DCMT11T308-23	0.031"																		●	
Medium cutting		24	DCMT 21.50.5-24	DCMT070202-24	0.008"																	●		
			DCMT 21.51-24	DCMT070204-24	0.016"	●	●					●											●	
			DCMT 21.52-24	DCMT070208-24	0.031"		●					●											●	
			DCMT 32.50.5-24	DCMT11T302-24	0.008"		●					●												●
			DCMT 32.51-24	DCMT11T304-24	0.016"	●	●					●												●
	DCMT 32.52-24	DCMT11T308-24	0.031"	●	●	●				●												●		

● : Line up

Reference pages

External toolholders → B228 - Internal toolholders → B313 -
 J series toolholders → B365 - B369



Insert



Positive



D



Insert

TurnLine - Insert

● : Continuous cutting
● : Light interrupted cutting
* : Heavy interrupted cutting

POSITIVE TYPE



Rhombic, 55°
with hole
Positive 7°

P	Steel	●●●*	●	*	●*	*			●●	●	●●	●	●●	●●	●●	●
M	Stainless			●	●	●*	*		●●	●	●●	●	●●	●●	●●	●
K	Cast iron	●●						●●	●	●●	●	●●	●	●●	●●	●
N	Non-ferrous															●
S	Superalloys								●●	●						
H	Hard materials															

Positive

Application	Chipbreaker	Designation		Corner radius	Coated										Coated cermet	Cermet	Uncoated		
		Inch	Metric		T9115	T9125	T6120	T6130	AH630	AH645	T515	T5115	AH120	AH725	GH330	GH730	GT9530	NS9530	TH10
Finishing		W10	DCGT 21.5VR-W10	DCGT070200R-W10	0.0012"													●	
				DCGT 21.5VL-W10	DCGT070200L-W10	0.0012"													●
				DCGT 21.50.5R-W10	DCGT070202R-W10	0.008"												●	●
				DCGT21.50.5L-W10	DCGT070202L-W10	0.008"										●	●		
				DCGT 21.51R-W10	DCGT070204R-W10	0.016"								●				●	●
				DCGT 21.51L-W10	DCGT070204L-W10	0.016"								●		●	●	●	
		W15	DCGT 32.50.5R-W15	DCGT11T302R-W15	0.008"												●	●	
				DCGT 32.50.5L-W15	DCGT11T302L-W15	0.008"										●	●		
				DCGT 32.51R-W15	DCGT11T304R-W15	0.016"											●		
				DCGT 32.51L-W15	DCGT11T304L-W15	0.016"								●		●	●	●	
				DCGT 32.52R-W15	DCGT11T308R-W15	0.031"											●	●	
				DCGT 32.52L-W15	DCGT11T308L-W15	0.031"											●	●	
Medium cutting		PM	DCMT 21.51 PM	DCMT070204-PM	0.016"	●	●	●	●	●		●	●		●	●			
				DCMT 21.52 PM	DCMT070208-PM	0.031"	●	●	●	●	●		●	●		●	●		
				DCMT 32.51 PM	DCMT11T304-PM	0.016"	●	●	●	●	●		●	●		●	●		
				DCMT 32.52 PM	DCMT11T308-PM	0.031"	●	●	●	●	●		●	●		●	●		
				DCMT 32.53 PM	DCMT11T312-PM	0.047"	●	●	●	●	●			●					
Finishing to medium cutting		CM	DCMT 21.51 CM	DCMT070204-CM	0.016"						●								
				DCMT 21.52 CM	DCMT070208-CM	0.031"						●							
				DCMT 32.51 CM	DCMT11T304-CM	0.016"						●	●						
				DCMT 32.52 CM	DCMT11T308-CM	0.031"						●	●						
				DCMT 32.53 CM	DCMT11T312-CM	0.047"							●						

● : Line up

Reference pages

External toolholders → B228 - Internal toolholders → B313 -
J series toolholders → B365 - B369

TurnLine - Insert

● : Continuous cutting
 ● : Light interrupted cutting
 * : Heavy interrupted cutting

POSITIVE TYPE



Rhombic, 55°
with hole
Positive 7°

	P	M	K	N	S	H
Steel	●					
Stainless		●				
Cast iron	●	●	●			
Non-ferrous				●		
Superalloys					●	
Hard materials						●

Application	Chipbreaker	Designation		Corner radius	Coated			Cermet	Uncoated	
		Inch	Metric		T9105	T5115	GH110	NS9530	TH10	KS05F
Finishing to medium cutting	AL 	DCGT 21.50.5 AL	DCGT070202-AL	0.008"						
		DCGT 21.51 AL	DCGT070204-AL	0.016"					●	
		DCGT 32.50.5 AL	DCGT11T302-AL	0.008"					●	
		DCGT 32.51 AL	DCGT11T304-AL	0.016"					●	
		DCGT 32.52 AL	DCGT11T308-AL	0.031"					●	
	All-round 	DCGT 21.50.5	DCGT070202	0.008"				●		
		DCGT 21.51	DCGT070204	0.016"				●		
		DCGT 32.50.5	DCGT11T302	0.008"				●		
		DCGT 32.51	DCGT11T304	0.016"				●		
		DCGT 32.52	DCGT11T308	0.031"				●		
	Angular 	DCGT 21.50.5 R	DCGT070202R	0.008"					●	
		DCGT 21.50.5 L	DCGT070202L	0.008"					●	
		DCGT 21.51 R	DCGT070204R	0.016"					●	
		DCGT 21.51 L	DCGT070204L	0.016"					●	
		DCGT 32.50.5 R	DCGT11T302R	0.008"					●	
DCGT 32.50.5 L		DCGT11T302L	0.008"					●		
DCGT 32.51 R		DCGT11T304R	0.016"					●		
DCGT 32.51 L	DCGT11T304L	0.016"					●			
Medium cutting	- 	DCMW 21.51	DCMW070204	0.016"	●	●				
		DCMW 21.52	DCMW070208	0.031"		●				
		DCMW 32.51	DCMW11T304	0.016"	●	●				
		DCMW 32.52	DCMW11T308	0.031"		●				
	- 	DCGW 21.50.5	DCGW070202	0.008"					●	
		DCGW 21.51	DCGW070204	0.016"			●		●	
		DCGW 32.51	DCGW11T304	0.016"					●	
		DCGW 32.52	DCGW11T308	0.031"					●	

● : Line up

Reference pages

External toolholders → B228 - Internal toolholders → B313 -
 J series toolholders → B365 - B369





Insert

TurnLine - Insert

● : Continuous cutting
 ● : Light interrupted cutting
 * : Heavy interrupted cutting

POSITIVE TYPE



**Rhombic, 55°
 with hole
 Positive 7°**

	P Steel	M Stainless	K Cast iron	N Non-ferrous	S Superalloys	H Hard materials
●	●	●	●	●	●	●
●	●	●	●	●	●	●
●	●	●	●	●	●	●
●	●	●	●	●	●	●
●	●	●	●	●	●	●
●	●	●	●	●	●	●
●	●	●	●	●	●	●
●	●	●	●	●	●	●
●	●	●	●	●	●	●
●	●	●	●	●	●	●

Application	Chipbreaker	Designation		Corner radius	Coated																			
		Inch	Metric		AH725	SH725	SH730																	
For external turning on small lathes (Sharp edge)		JS	DCGT 21.5 VFN-JS	DCGT070200FN-JS	0.0012"	●	●																	
			DCGT 21.50 FN-JS	DCGT070201FN-JS	0.004"		●	●																
			DCGT 21.50.5 FN-JS	DCGT070202FN-JS	0.008"		●	●																
			DCGT 32.5 VFN-JS	DCGT11T300FN-JS	0.0012"		●	●																
			DCGT 32.50 FN-JS	DCGT11T301FN-JS	0.004"		●	●																
			DCGT 32.50.5 FN-JS	DCGT11T302FN-JS	0.008"		●	●																
			DCGT 32.51 FN-JS	DCGT11T304FN-JS	0.016"		●	●																
For external turning on small lathes		JS	DCGT 21.50 N-JS	DCGT070201N-JS	0.004"	●																		
			DCGT 21.50.5 N-JS	DCGT070202N-JS	0.008"	●																		
			DCGT 32.50 N-JS	DCGT11T301N-JS	0.004"	●																		
			DCGT 32.50.5 N-JS	DCGT11T302N-JS	0.008"	●																		
			DCGT 32.51 N-JS	DCGT11T304N-JS	0.016"	●																		
For external turning on small lathes (Sharp edge)		JPP	DCET 21.5U MFR JPP	DCET0702008MFR-JPP	<0.0031**	●	●																	
			DCET 21.5U MFL JPP	DCET0702008MFL-JPP	<0.0031**	●	●																	
			DCET 21.50 MFR JPP	DCET070201MFR-JPP	<0.004**	●	●																	
			DCET 21.50 MFL JPP	DCET070201MFL-JPP	<0.004**	●	●																	
			DCET 21.50.4 MFR JPP	DCET0702018MFR-JPP	<0.007**	●	●																	
			DCET 21.50.4 MFL JPP	DCET0702018MFL-JPP	<0.007**	●	●																	
			DCET 21.50.5 MFR JPP	DCET070202MFR-JPP	<0.008**	●	●																	
			DCET 21.50.5 MFL JPP	DCET070202MFL-JPP	<0.008**	●	●																	
			DCET 32.5U MFR JPP	DCET11T3008MFR-JPP	<0.0031**	●	●																	
			DCET 32.5U MFL JPP	DCET11T3008MFL-JPP	<0.0031**	●	●																	
			DCET 32.50 MFR JPP	DCET11T301MFR-JPP	<0.004**	●	●																	
			DCET 32.50 MFL JPP	DCET11T301MFL-JPP	<0.004**	●	●																	
			DCET 32.50.4 MFR JPP	DCET11T3018MFR-JPP	<0.007**	●	●																	
			DCET 32.50.4 MFL JPP	DCET11T3018MFL-JPP	<0.007**	●	●																	
			DCET 32.50.5 MFR JPP	DCET11T302MFR-JPP	<0.008**	●	●																	
			DCET 32.50.5 MFL JPP	DCET11T302MFL-JPP	<0.008**	●	●																	

* Corner radius has minus tolerance.
 Note: See page B051 for chipbreaker descriptions.

● : Line up

Reference pages

External toolholders → **B228** - Internal toolholders → **B312** -
 J series toolholders → **B365** - **B369**

TurnLine - Insert

● : Continuous cutting
 ● : Light interrupted cutting
 * : Heavy interrupted cutting

POSITIVE TYPE



**Rhombic, 55°
with hole
Positive 7°**

P Steel	●●●●●●	●●	●●	●●	●															
M Stainless	●●●●●●				●				●											
K Cast iron					●●			●●												
N Non-ferrous																				●
S Superalloys					●●															
H Hard materials																				

Application	Chipbreaker	Designation		Corner radius	Coated			Coated cermet	Cermet	Uncoated	
		Inch	Metric		SH725	SH730	J740	J9530	NS9530	TH10	
For external turning on small lathes (Sharp edge)	JRP	DCET 21.5U MFR JRP	DCET0702008MFR-JRP	<0.0031**	●	●	●				
		DCET 21.5U MFL JRP	DCET0702008MFL-JRP	<0.0031**	●	●					
		DCET 21.5U MFR JRP	DCET070201MFR-JRP	<0.004**	●	●					
		DCET 21.5U MFL JRP	DCET070201MFL-JRP	<0.004**	●	●					
		DCET 21.50.4 MFR JRP	DCET0702018MFR-JRP	<0.007**	●	●					
		DCET 21.50.4 MFL JRP	DCET0702018MFL-JRP	<0.007**	●	●					
		DCET 21.50.5 MFR JRP	DCET070202MFR-JRP	<0.008**	●	●					
		DCET 21.50.5 MFL JRP	DCET070202MFL-JRP	<0.008**	●	●					
		DCET 32.5U MFR JRP	DCET11T3008MFR-JRP	<0.0031**	●	●					
		DCET 32.5U MFL JRP	DCET11T3008MFL-JRP	<0.0031**	●	●					
		DCET 32.5U MFR JRP	DCET11T301MFR-JRP	<0.004**	●	●					
		DCET 32.5U MFL JRP	DCET11T301MFL-JRP	<0.004**	●	●					
		DCET 32.50.4 MFR JRP	DCET11T3018MFR-JRP	<0.007**	●	●					
		DCET 32.50.4 MFL JRP	DCET11T3018MFL-JRP	<0.007**	●	●					
		DCET 32.50.5 MFR JRP	DCET11T302MFR-JRP	<0.008**	●	●					
		DCET 32.50.5 MFL JRP	DCET11T302MFL-JRP	<0.008**	●	●					
	JSP	DCET 21.5U MFN-JSP	DCET0702008MFN-JSP	<0.0031**	●	●					
		DCET 21.5U MFN-JSP	DCET070201MFN-JSP	<0.004**	●	●					
		DCET 21.50.4 MFN-JSP	DCET0702018MFN-JSP	<0.007**	●	●					
		DCET 21.50.5 MFN-JSP	DCET070202MFN-JSP	<0.008**	●	●					
DCET 32.50.4 MFN-JSP		DCET11T3008MFN-JSP	<0.0031**	●	●						
DCET 32.5U MFN-JSP		DCET11T301MFN-JSP	<0.004**	●	●						
DCET 32.50.4 MFN-JSP		DCET11T3018MFN-JSP	<0.007**	●	●						
DCET 32.50.5 MFN-JSP		DCET11T302MFN-JSP	<0.008**	●	●						
J10	DCGT 21.5VFR J10	DCGT070200FR-J10	0.0012"	●	●					●	
	DCGT 21.5VFL J10	DCGT070200FL-J10	0.0012"	●	●					●	
	DCGT 21.50FR J10	DCGT070201FR-J10	0.004"	●	●			●		●	
	DCGT 21.50FL J10	DCGT070201FL-J10	0.004"	●	●			●		●	
	DCGT 21.50.5FR J10	DCGT070202FR-J10	0.008"	●	●			●		●	
	DCGT 21.50.5FL J10	DCGT070202FL-J10	0.008"	●	●			●		●	
	DCGT 21.51 FR J10	DCGT070204FR-J10	0.016"	●							
	DCGT 21.51 FL J10	DCGT070204FL-J10	0.016"	●							
	DCGT 32.5VFR J10	DCGT11T300FR-J10	0.0012"	●	●					●	
	DCGT 32.5VFL J10	DCGT11T300FL-J10	0.0012"	●	●					●	
	DCGT 32.50FR J10	DCGT11T301FR-J10	0.004"	●	●			●		●	
	DCGT 32.50FL J10	DCGT11T301FL-J10	0.004"	●	●			●		●	
	DCGT 32.50.5FR J10	DCGT11T302FR-J10	0.008"	●	●			●		●	
	DCGT 32.50.5FL J10	DCGT11T302FL-J10	0.008"	●	●			●		●	
On small lathes (Honed edge)	J10	DCGT 21.50.5R J10	DCGT070202R-J10	0.008"				●			
		DCGT 32.50.5R J10	DCGT11T302R-J10	0.008"				●			

* Corner radius has minus tolerance.
 Note: See page B051 for chipbreaker descriptions.

● : Line up



Insert

Positive

D



Insert

TurnLine - Insert





- : Continuous cutting
- : Light interrupted cutting
- : Heavy interrupted cutting

POSITIVE TYPE DOUBLE-SIDED

Rhombic, 55°
with hole



Material	Steel	Stainless	Cast iron	Non-ferrous	Superalloys	Hard materials
P	●●●	●●●	●●●			
M	●●●	●●●	●●●			
K	●●●	●●●	●●●			
N				●●●		
S					●●●	
H						●●●

Application	Chipbreaker	Designation		Corner radius	Coated																
		Inch	Metric		AH725	SH725															
Finishing (Sharp edge)		JRP	DXGU 220-MFRE-JRP	DXGU070301MFRE-JRP	<0.004**	●															
			DXGU 220-MFLE-JRP	DXGU070301MFLE-JRP	<0.004**	●															
			DXGU 220.5-MFRE-JRP	DXGU070302MFRE-JRP	<0.008**	●															
			DXGU 220.5-MFLE-JRP	DXGU070302MFLE-JRP	<0.008**	●															
Finishing to medium cutting (Sharp edge)		JTS	DXGU 220-MFR-JTS	DXGU070301MFR-JTS	<0.004**	●															
			DXGU 220-MFL-JTS	DXGU070301MFL-JTS	<0.004**	●															
			DXGU 220.5-MFR-JTS	DXGU070302MFR-JTS	<0.008**	●															
			DXGU 220.5-MFL-JTS	DXGU070302MFL-JTS	<0.008**	●															
Finishing to medium cutting		JTS	DXGU 220-MR-JTS	DXGU070301MR-JTS	<0.004**	●															
			DXGU 220-ML-JTS	DXGU070301ML-JTS	<0.004**	●															
			DXGU 220.5-MR-JTS	DXGU070302MR-JTS	<0.008**	●															
			DXGU 220.5-ML-JTS	DXGU070302ML-JTS	<0.008**	●															
Finishing (Low cutting force) (Sharp edge)		JSS	DXGU 220-MFR-JSS	DXGU070301MFR-JSS	<0.004**	●															
			DXGU 220-MFL-JSS	DXGU070301MFL-JSS	<0.004**	●															
			DXGU 220.5-MFR-JSS	DXGU070302MFR-JSS	<0.008**	●															
			DXGU 220.5-MFL-JSS	DXGU070302MFL-JSS	<0.008**	●															

* Corner radius has minus tolerance.

● : Line up

Reference pages

External toolholders → **B192** -

Internal toolholders → **B288, B289**

D



TurnLine - Insert

● : Continuous cutting
 ●● : Light interrupted cutting
 ●●● : Heavy interrupted cutting

**POSITIVE TYPE
 DOUBLE-SIDED**

 **Rhombic, 55°
 with hole**

P Steel	●			●●		●●															
M Stainless	●			●●		●●															
K Cast iron	●			●●		●●		●													
N Non-ferrous													●								
S Superalloys													●								
H Hard materials																					

Application	Chipbreaker	Designation		Corner radius	Coated	Coated cermet	Cermet	Uncoated																			
		Inch	Metric		AH725	GT9530	NS9530	KS05F																			
Finishing (Low cutting force)		JSS	DXGU 220 MR-JSS	DXGU070301MR-JSS	<0.004**	●																					
			DXGU 220 ML-JSS	DXGU070301ML-JSS	<0.004**	●																					
			DXGU 220.5 MR-JSS	DXGU070302MR-JSS	<0.008**	●																					
			DXGU 220.5 ML-JSS	DXGU070302ML-JSS	<0.008**	●																					
Finishing to medium cutting		TS	DXGU 220.5 R-TS	DXGU070302R-TS	0.008"	●	●	●	●																		
			DXGU 220.5 L-TS	DXGU070302L-TS	0.008"	●	●	●	●																		
			DXGU 221 R-TS	DXGU070304R-TS	0.016"	●	●	●	●																		
			DXGU 221 L-TS	DXGU070304L-TS	0.016"	●	●	●	●																		
			DXGU 222 R-TS	DXGU070308R-TS	0.031"	●	●	●	●																		
			DXGU 222 L-TS	DXGU070308L-TS	0.031"	●	●	●	●																		
Finishing (Low cutting force)		SS	DXGU 220.5 R-SS	DXGU070302R-SS	0.008"	●	●	●	●																		
			DXGU 220.5 L-SS	DXGU070302L-SS	0.008"	●	●	●	●																		
			DXGU 221 R-SS	DXGU070304R-SS	0.016"	●	●	●	●																		
			DXGU 221 L-SS	DXGU070304L-SS	0.016"	●	●	●	●																		

* Corner radius has minus tolerance.



Insert



Positive



D

Reference pages

External toolholders → **B192** -
 Internal toolholders → **B288, B289**



Insert

TurnLine - Insert

● : Continuous cutting
◐ : Light interrupted cutting
✱ : Heavy interrupted cutting

POSITIVE TYPE

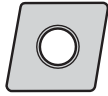

Rhombic, 75°
with hole
Positive 11°

	P	M	K	N	S	H													
Steel	●	●	●	●	●	●	●	●	●	●	●	●	●	●	●	●	●	●	●
Stainless	●	●	●	●	●	●	●	●	●	●	●	●	●	●	●	●	●	●	●
Cast iron	●	●	●	●	●	●	●	●	●	●	●	●	●	●	●	●	●	●	●
Non-ferrous				●															
Superalloys	●	●	●	●	●	●	●	●	●	●	●	●	●	●	●	●	●	●	●
Hard materials																			

Application	Chipbreaker	Designation		Corner radius	Coated			Coated cermet	Cermet	Uncoated			
		Inch	Metric		GH110	SH725	SH730	GT9530	NS9530	TH10	UX30		
Finishing		W08	EPGT 4.51.8 R-W08	EPGT03X100R-W08	0.0012"	●	●	●	●	●	●		
			EPGT 4.51.8 L-W08	EPGT03X100L-W08	0.0012"	●	●	●	●	●	●		
			EPGT 4.51.80 R-W08	EPGT03X101R-W08	0.004"	●	●	●	●	●	●		
			EPGT 4.51.80 L-W08	EPGT03X101L-W08	0.004"	●	●	●	●	●	●		
			EPGT 4.51.80.5 R-W08	EPGT03X102R-W08	0.008"	●	●	●	●	●	●		
			EPGT 4.51.80.5 L-W08	EPGT03X102L-W08	0.008"	●	●	●	●	●	●		
			EPGT 4.51.81 R-W08	EPGT03X104R-W08	0.016"	●	●	●	●	●	●		
			EPGT 4.51.81 L-W08	EPGT03X104L-W08	0.016"	●	●	●	●	●	●		
			EPGT 52 R-W08	EPGT040100R-W08	0.0012"	●	●	●	●	●	●		
			EPGT 52 L-W08	EPGT040100L-W08	0.0012"	●	●	●	●	●	●		
			EPGT 520 R-W08	EPGT040101R-W08	0.004"	●	●	●	●	●	●		
			EPGT 520 L-W08	EPGT040101L-W08	0.004"	●	●	●	●	●	●		
			EPGT 520.5 R-W08	EPGT040102R-W08	0.008"	●	●	●	●	●	●		
			EPGT 520.5 L-W08	EPGT040102L-W08	0.008"	●	●	●	●	●	●		
			EPGT 521 R-W08	EPGT040104R-W08	0.016"	●	●	●	●	●	●		
			EPGT 521 L-W08	EPGT040104L-W08	0.016"	●	●	●	●	●	●		
		Finishing (Sharp edge)		W08	EPGT 4.51.8 FR-W08	EPGT03X100FL-W08	0.0012"	●	●	●	●	●	●
					EPGT 4.51.8 FL-W08	EPGT03X100FR-W08	0.0012"	●	●	●	●	●	●
	EPGT 4.51.80 FR-W08			EPGT03X101FL-W08	0.004"	●	●	●	●	●	●		
	EPGT 4.51.80 FL-W08			EPGT03X101FR-W08	0.004"	●	●	●	●	●	●		
	EPGT 4.51.80.5 FR-W08			EPGT03X102FL-W08	0.008"	●	●	●	●	●	●		
	EPGT 4.51.80.5 FL-W08			EPGT03X102FR-W08	0.008"	●	●	●	●	●	●		
	EPGT 4.51.81 FR-W08			EPGT03X104FL-W08	0.016"	●	●	●	●	●	●		
	EPGT 4.51.81 FL-W08			EPGT03X104FR-W08	0.016"	●	●	●	●	●	●		
	EPGT 52 FR-W08			EPGT040100FL-W08	0.0012"	●	●	●	●	●	●		
	EPGT 52 FL-W08			EPGT040100FR-W08	0.0012"	●	●	●	●	●	●		
	EPGT 520 FR-W08			EPGT040101FL-W08	0.004"	●	●	●	●	●	●		
	EPGT 520 FL-W08			EPGT040101FR-W08	0.004"	●	●	●	●	●	●		
	EPGT 520.5 FR-W08			EPGT040102FL-W08	0.008"	●	●	●	●	●	●		
	EPGT 520.5 FL-W08			EPGT040102FR-W08	0.008"	●	●	●	●	●	●		
	EPGT 521 FR-W08			EPGT040104FL-W08	0.016"	●	●	●	●	●	●		
	EPGT 521 FL-W08			EPGT040104FR-W08	0.016"	●	●	●	●	●	●		

● : Line up

Reference pages

Internal toolholders → B302 -

TurnLine - Insert

● : Continuous cutting
 ● : Light interrupted cutting
 * : Heavy interrupted cutting

POSITIVE TYPE

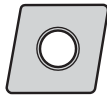

**Rhombic, 75°
with hole
Positive 11°**

P Steel	●●●●●●
M Stainless	●●●●●●
K Cast iron	
N Non-ferrous	
S Superalloys	●●
H Hard materials	

Application	Chipbreaker	Designation		Corner radius	Coated																			
		Inch	Metric		SH725	SH730	J740																	
		For internal turning on small lathes																						
For internal turning on small lathes (Sharp edge)		JS	EPGT 4.51.80 JS	EPGT03X101-JS	0.004"	●																		
			EPGT 4.51.80.5 JS	EPGT03X102-JS	0.008"	●																		
			EPGT 4.51.81 JS	EPGT03X104-JS	0.016"	●																		
			EPGT 520 JS	EPGT040101-JS	0.004"	●																		
			EPGT 520.5 JS	EPGT040102-JS	0.008"	●																		
			EPGT 521 JS	EPGT040104-JS	0.016"	●																		
Finishing		J08	EPGT 52 L-J08	EPGT040100L-J08	0.0012"	●	●																	
			EPGT 520.5 L-J08	EPGT040102L-J08	0.008"	●	●																	
			EPGT 521 L-J08	EPGT040104L-J08	0.016"	●	●																	
		Finishing (Sharp edge)		J08	EPGT 52 FL-J08	EPGT040100FL-J08	0.0012"	●																
					EPGT 520.5 FL-J08	EPGT040102FL-J08	0.008"	●																
					EPGT 521 FL-J08	EPGT040104FL-J08	0.016"	●																

● : Line up

Reference pages

Internal toolholders → B302 -



Insert

Positive

E



Insert

TurnLine - Insert

● : Continuous cutting
 ● : Light interrupted cutting
 * : Heavy interrupted cutting

POSITIVE TYPE



Round,
with hole
Positive 7°

	P	M	K	N	S	H
Steel	●●●●*	●●	●●			
Stainless		●●●●	●●			
Cast iron	●●	●●	●●●●			
Non-ferrous				●●●●		
Superalloys				●●	●●	
Hard materials						

Application	Chipbreaker	Designation	Corner radius	Coated						Uncoated									
				Inch		Metric		T9115	T9125	T5115	AH120	AH8005	AH8015	AH905	KS05F				
Finishing to medium cutting	RS 	-	RCMT10T3M0-RS	-	●	●													
		-	RCMT1204M0-RS	-	●	●		●	●	●	●								
		-	RCMT1606M0-RS	-	●	●		●											
		-	RCMT2006M0-RS	-		●													
		-	RCMT2507M0-RS	-		●													
	CM 	-	RCMT0502M0-CM	-			●												
		-	RCMT0602M0-CM	-			●												
		-	RCMT0803M0-CM	-			●												
	AL 	-	RCGT0602M0-AL	-										●					
		-	RCGT0803M0-AL	-										●					
		-	RCGT1003M0-AL	-										●					

● : Line up

R

Reference pages

External toolholders → B245 -

TurnLine - Insert

● : Continuous cutting
 ● : Light interrupted cutting
 * : Heavy interrupted cutting

POSITIVE TYPE



Round, with hole Positive 7°

Material	Steel	Stainless	Cast iron	Non-ferrous	Superalloys	Hard materials
P	● ● ● *					● ● ● *
M		● ● ● *				● ● ● *
K			● ● ● *			● ● ● *
N				● ● ● *		● ● ● *
S					● ● ● *	
H						

Application	Chipbreaker	Designation	Corner radius	Coated					Cermet	Uncoated	
				Inch	Metric	T9115	T9125	AH8005	AH8015	AH905	NS9530
Heavy cutting	61	-	RCMT0502M0-61	-	● ● ● *					● ● ● *	
		-	RCMT0602M0-61	-	● ● ● *					● ● ● *	
		-	RCMT0803M0-61	-	● ● ● *					● ● ● *	
	61	-	RCMM1003M0-61	-	● ● ● *	● ● ● *	● ● ● *			● ● ● *	
		-	RCMM1204M0-61	-	● ● ● *	● ● ● *	● ● ● *			● ● ● *	
		-	RCMM1606M0-61	-	● ● ● *	● ● ● *				● ● ● *	
		-	RCMM2006M0-61	-	● ● ● *	● ● ● *				● ● ● *	
		-	RCMM2507M0-61	-	● ● ● *	● ● ● *				● ● ● *	

Designation	0502M0	0602M0	0803M0	1003M0	10T3M0	1204M0	1606M0	2006M0	2507M0
RC*T	0.098	0.110	0.134	0.173	0.173	0.173	0.217	0.256	0.299
RCMM	-	-	-	0.142	-	0.165	0.205	0.256	0.283



Insert

Positive

R

Special Round Insert



Material	Steel	Stainless	Cast iron	Non-ferrous	Superalloys	Hard materials
P	●					
M	●	● ● ● *				
K			● ● ● *			
N				● ● ● *		
S					● ● ● *	
H						

Application	Chipbreaker	Designation	Corner radius	Uncoated							
				Inch	Metric	TH10	KS20				
Medium cutting		-	RT05	-	● ● ● *						
		-	RT06	-	● ● ● *	● ● ● *					
		-	RT08	-	● ● ● *	● ● ● *					

Reference pages

RC... : External toolholders → B245 -

RT... : External toolholders → B268

● : Line up

TurnLine - Insert

● : Continuous cutting
 ● : Light interrupted cutting
 * : Heavy interrupted cutting

POSITIVE TYPE

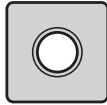

Square, 90°
 with hole
 Positive 7°

Material	Steel	Stainless	Cast iron	Non-ferrous	Superalloys	Hard materials
P	●●●*	●	●●	●	●	●●●
M	●	●●●*	●●	●	●	●●●
K	●●	●	●●●*	●	●	●●●
N	●	●●●*	●	●●●*	●	●●●
S	●	●	●	●	●●●*	●●●
H	●	●	●	●	●	●●●

Application	Chipbreaker	Designation		Corner radius	Coated								Coated cermet	Cermet			
		Inch	Metric		T9115	T9125	T6120	T6130	AH630	AH645	T515	T5115	AH120	AH725	GT9530	NS9530	
Finishing to medium cutting		PS	SCMT 32.51 PS	SCMT09T304-PS	0.016"	●	●	●	●	●	●				●	●	
			SCMT 32.52 PS	SCMT09T308-PS	0.031"	●	●	●	●	●	●				●	●	
			SCMT 431 PS	SCMT120404-PS	0.016"	●	●	●	●	●	●				●	●	
			SCMT 432 PS	SCMT120408-PS	0.031"	●	●	●	●	●	●				●	●	
Finishing to medium cutting		23	SCMT 32.50.5-23	SCMT09T302-23	0.008"										●		
			SCMT 32.52-23	SCMT09T308-23	0.031"		●					●					
			SCMT 432-23	SCMT120408-23	0.031"		●					●	●				
Medium cutting		24	SCMT 2.51.51-24	SCMT070204-24	0.016"		●									●	
			SCMT 32.50.5-24	SCMT09T302-24	0.008"											●	
			SCMT 32.51-24	SCMT09T304-24	0.016"		●									●	
			SCMT 32.52-24	SCMT09T308-24	0.031"	●	●					●				●	
			SCMT 431-24	SCMT120404-24	0.016"		●									●	
			SCMT 432-24	SCMT120408-24	0.031"		●		●			●				●	
Medium cutting		PM	SCMT 32.51 PM	SCMT09T304-PM	0.016"	●	●	●	●	●	●				●	●	
			SCMT 32.52 PM	SCMT09T308-PM	0.031"	●	●	●	●	●	●				●	●	
			SCMT 432 PM	SCMT120408-PM	0.031"	●	●	●	●	●	●				●	●	
			SCMT 433 PM	SCMT120412-PM	0.047"		●	●	●	●	●				●	●	
Finishing to medium cutting		CM	SCMT 32.51 CM	SCMT09T304-CM	0.016"						●	●					
			SCMT 32.52 CM	SCMT09T308-CM	0.031"						●	●					
			SCMT 32.53 CM	SCMT09T312-CM	0.047"							●					
			SCMT 431 CM	SCMT120404-CM	0.016"						●	●					
			SCMT 432 CM	SCMT120408-CM	0.031"						●	●					

● : Line up

Reference pages

External toolholders → B266



Insert

Positive

S



Insert

TurnLine - Insert

● : Continuous cutting
●c : Light interrupted cutting
* : Heavy interrupted cutting

POSITIVE TYPE



Square, 90°
with hole
Positive 11°

P	Steel	●	●c	●c	*	●c	*	●c	●c					●c		●c		●	
M	Stainless			●	●c	●c	*	●c	●c					●c		●c		●	
K	Cast iron	●c						●c	●c					●c		●c		●	
N	Non-ferrous																	●	
S	Superalloys								●c	●									
H	Hard materials																		

Application	Chipbreaker	Designation		Corner radius	Coated							Coated cermet	Cermet	Uncoated			
		Inch	Metric		T9115	T9125	T6120	T6130	AH630	AH645	AH120	AH725	GT9530	NS9530	TH10		
Finishing to medium cutting		PS	SPMT321 PS	SPMT090304-PS	0.016"	●	●	●	●	●	●	●		●			
			SPMT322 PS	SPMT090308-PS	0.031"	●	●	●	●	●	●	●		●			
			SPMT431 PS	SPMT120404-PS	0.016"	●	●	●	●	●	●	●					
			SPMT432 PS	SPMT120408-PS	0.031"	●	●	●	●	●	●	●					
Finishing to medium cutting		23	SPMT321-23	SPMT090304-23	0.016"	●								●			
			SPMT322-23	SPMT090308-23	0.031"	●									●		
Medium cutting		24	SPMT 321-24	SPMT090304-24	0.016"	●								●			
			SPMT 322-24	SPMT090308-24	0.031"	●					●				●		
			SPMT 431-24	SPMT120404-24	0.016"										●		
			SPMT 432-24	SPMT120408-24	0.031"							●			●		
Finishing		W15	SPGT 320.5L W15	SPGT090302L-W15	0.008"									●			
			SPGT 321L W15	SPGT090304L-W15	0.016"									●		●	
			SPGT 322R W15	SPGT090308R-W15	0.031"										●		●
			SPGT 322L W15	SPGT090308L-W15	0.031"										●		●
		W20	SPGT431L W20	SPGT120404L-W20	0.016"										●		

● : Line up

Reference pages

External toolholders → B258 - Internal toolholders → B307, B335

TurnLine - Insert



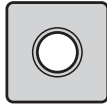

● : Continuous cutting
 ●● : Light interrupted cutting
 ●●● : Heavy interrupted cutting

POSITIVE TYPE



Square, 90°
 with hole
 Positive 11°

Material	Coated	Cermet	Uncoated
P Steel			●●											
M Stainless			●●											
K Cast iron	●●	●●	●●											
N Non-ferrous			●●											
S Superalloys														
H Hard materials														

Application	Chipbreaker	Designation		Corner radius	Coated		Cermet		Uncoated					
		Inch	Metric		T515	T515	NS9530	TH10						
Finishing to medium cutting	CM 	SPMT 321 CM	SPMT090304-CM	0.016"		●								
		SPMT 322 CM	SPMT090308-CM	0.031"		●								
		SPMT 431 CM	SPMT120404-CM	0.016"	●	●								
		SPMT 432 CM	SPMT120408-CM	0.031"	●	●								
	-	SPGM 321L	SPGM090304L	0.016"			●							
	(Tungaloy's standard hole) 	SPGM 421L	SPGM120304L	0.016"			●							
		SPGM 422 L	SPGM120308L	0.031"			●							
	-	SPMW 321	SPMW090304	0.016"		●								
		SPMW 322	SPMW090308	0.031"		●								
		SPMW 431	SPMW120404	0.016"		●								
		SPMW 432	SPMW120408	0.031"		●								
		-	SPGW 320.5	SPGW090302	0.008"					●				
	SPGW 321	SPGW090304	0.016"					●						
	SPGW 431	SPGW120404	0.016"					●						
	-	SPGA 321	SPGA090304	0.016"			●							
(Tungaloy's standard hole) 														

● : Line up



Insert



Positive



S

Reference pages

External toolholders → B258 - Internal toolholders → B307, B335

TurnLine - Insert

● : Continuous cutting
 ● : Light interrupted cutting
 * : Heavy interrupted cutting

POSITIVE TYPE



**Triangular, 60°
with hole
Positive 7°**

P Steel	●●●●	●●●●	●●●●	●●●●	●●●●	●●●●	●●●●	●●●●	●●●●	●●●●	●●●●	●●●●	●●●●	●●●●	●●●●	●●●●	●●●●	●●●●	●●●●	●●●●	●●●●
M Stainless	●●●●	●●●●	●●●●	●●●●	●●●●	●●●●	●●●●	●●●●	●●●●	●●●●	●●●●	●●●●	●●●●	●●●●	●●●●	●●●●	●●●●	●●●●	●●●●	●●●●	●●●●
K Cast iron	●●●●	●●●●	●●●●	●●●●	●●●●	●●●●	●●●●	●●●●	●●●●	●●●●	●●●●	●●●●	●●●●	●●●●	●●●●	●●●●	●●●●	●●●●	●●●●	●●●●	●●●●
N Non-ferrous	●●●●	●●●●	●●●●	●●●●	●●●●	●●●●	●●●●	●●●●	●●●●	●●●●	●●●●	●●●●	●●●●	●●●●	●●●●	●●●●	●●●●	●●●●	●●●●	●●●●	●●●●
S Superalloys	●●●●	●●●●	●●●●	●●●●	●●●●	●●●●	●●●●	●●●●	●●●●	●●●●	●●●●	●●●●	●●●●	●●●●	●●●●	●●●●	●●●●	●●●●	●●●●	●●●●	●●●●
H Hard materials	●●●●	●●●●	●●●●	●●●●	●●●●	●●●●	●●●●	●●●●	●●●●	●●●●	●●●●	●●●●	●●●●	●●●●	●●●●	●●●●	●●●●	●●●●	●●●●	●●●●	●●●●

Application	Chipbreaker	Designation		Corner radius	Coated					Coated cermet	Cermets		Uncoated		
		Inch	Metric		T9115	T9125	AH725	SH725	J740	GT9530	NS9530	NS520	TH10		
Precision finishing		01	TCGT731-01	TCGT090204-01	0.016"	●●●●	●●●●	●●●●	●●●●	●●●●	●●●●	●●●●	●●●●	●●●●	●●●●
			TCGT21.50.5-01	TCGT110202-01	0.008"			●●●●							
			TCGT21.51-01	TCGT110204-01	0.016"					●●●●	●●●●	●●●●	●●●●	●●●●	●●●●
			TCGT21.52-01	TCGT110208-01	0.031"				●●●●		●●●●			●●●●	●●●●
			TCGT32.51-01	TCGT16T304-01	0.016"									●●●●	●●●●
			TCGT32.52-01	TCGT16T308-01	0.031"							●●●●		●●●●	●●●●
Precision finishing (Sharp edge)		01	TCGT 21.50.5 F-01	TCGT110202F-01	0.008"			●●●●							
Finishing		PSF	TCMT 730.5 PSF	TCMT090202-PSF	0.008"			●●●●							
			TCMT 731 PSF	TCMT090204-PSF	0.016"	●●●●	●●●●	●●●●							
			TCMT 21.50.5 PSF	TCMT110202-PSF	0.008"			●●●●							
			TCMT 21.51 PSF	TCMT110204-PSF	0.016"	●●●●	●●●●	●●●●							
			TCMT 220.5 PSF	TCMT110302-PSF	0.008"			●●●●							
			TCMT 221 PSF	TCMT110304-PSF	0.016"	●●●●	●●●●	●●●●							
			TCMT 32.51 PSF	TCMT16T304-PSF	0.016"	●●●●	●●●●	●●●●							
Finishing to light cutting		PSS	TCMT 731 PSS	TCMT090204-PSS	0.016"	●●●●	●●●●	●●●●							
			TCMT 732 PSS	TCMT090208-PSS	0.031"	●●●●	●●●●	●●●●							
			TCMT 21.51 PSS	TCMT110204-PSS	0.016"	●●●●	●●●●	●●●●							
			TCMT 21.52 PSS	TCMT110208-PSS	0.031"	●●●●	●●●●	●●●●							
			TCMT 221 PSS	TCMT110304-PSS	0.016"	●●●●	●●●●	●●●●							
			TCMT 222 PSS	TCMT110308-PSS	0.031"	●●●●	●●●●	●●●●							
			TCMT 32.51 PSS	TCMT16T304-PSS	0.016"	●●●●	●●●●	●●●●							
			TCMT 32.52 PSS	TCMT16T308-PSS	0.031"	●●●●	●●●●	●●●●							
			TCMT 32.53 PSS	TCMT16T312-PSS	0.047"	●●●●	●●●●	●●●●							

● : Line up

Reference pages

External toolholders → **B262** Internal toolholders → **B308**

J series toolholders → **B370**



Insert



Positive



T



Insert

TurnLine - Insert

● : Continuous cutting
◐ : Light interrupted cutting
✱ : Heavy interrupted cutting

POSITIVE TYPE



Triangular, 60°
with hole
Positive 7°

P	Steel	●	●	●	✱	●	✱	●	●							●	●			●		
M	Stainless				●	●	●	✱	●	●											●	
K	Cast iron	●	●						●	●						●	●			●		
N	Non-ferrous																			●		
S	Superalloys								●													
H	Hard materials																					

Positive

Application	Chipbreaker	Designation		Corner radius	Coated								Coated cermet	Cermet	Uncoated									
		Inch	Metric		T9115	T9125	T6120	T6130	AH630	AH645	AH725	GH730	GT9530	NS9530	TH10									
Finishing to medium cutting		PS	TCMT 731 PS	TCMT090204-PS	0.016"																			
			TCMT 732 PS	TCMT090208-PS	0.031"																			
			TCMT 21.50.5 PS	TCMT110202-PS	0.008"	●	●	●	●	●	●	●	●	●	●	●	●	●	●	●	●	●	●	●
			TCMT 21.51 PS	TCMT110204-PS	0.016"	●	●	●	●	●	●	●	●	●	●	●	●	●	●	●	●	●	●	●
			TCMT 21.52 PS	TCMT110208-PS	0.031"	●	●	●	●	●	●	●	●	●	●	●	●	●	●	●	●	●	●	●
			TCMT 220.5 PS	TCMT110302-PS	0.008"	●	●	●	●	●	●	●	●	●	●	●	●	●	●	●	●	●	●	●
			TCMT 221 PS	TCMT110304-PS	0.016"	●	●	●	●	●	●	●	●	●	●	●	●	●	●	●	●	●	●	●
			TCMT 222 PS	TCMT110308-PS	0.031"	●	●	●	●	●	●	●	●	●	●	●	●	●	●	●	●	●	●	●
			TCMT 32.50 PS	TCMT16T302-PS	0.008"	●	●	●	●	●	●	●	●	●	●	●	●	●	●	●	●	●	●	●
			TCMT 32.51 PS	TCMT16T304-PS	0.016"	●	●	●	●	●	●	●	●	●	●	●	●	●	●	●	●	●	●	●
			TCMT 32.52 PS	TCMT16T308-PS	0.031"	●	●	●	●	●	●	●	●	●	●	●	●	●	●	●	●	●	●	●
			Finishing		23	TCMT 731-23	TCMT090204-23	0.016"		●														
TCMT 21.51-23	TCMT110204-23	0.016"																						
TCMT 32.51-23	TCMT16T304-23	0.016"																						
TCMT 32.52-23	TCMT16T308-23	0.031"					●																	
Medium cutting		24	TCMT 730.5-24	TCMT090202-24	0.008"																			
			TCMT 731-24	TCMT090204-24	0.016"	●	●																	
			TCMT 21.50.5-24	TCMT110202-24	0.008"																			
			TCMT 21.51-24	TCMT110204-24	0.016"	●	●																	
			TCMT 21.52-24	TCMT110208-24	0.031"		●																	
			TCMT 32.51-24	TCMT16T304-24	0.016"	●	●																	
			TCMT 32.52-24	TCMT16T308-24	0.031"	●	●						●											
Finishing		W15	TCGT 32.50.5L W15	TCGT16T302L-W15	0.008"																●			
			TCGT 32.51L W15	TCGT16T304L-W15	0.016"																	●	●	
			TCGT 32.52L W15	TCGT16T308L-W15	0.031"																		●	

● : Line up

Reference pages

External toolholders → B263 Internal toolholders → B308

J series toolholders → B370

TurnLine - Insert

● : Continuous cutting
 ● : Light interrupted cutting
 * : Heavy interrupted cutting

POSITIVE TYPE



Triangular, 60°
with hole
Positive 7°

	P	M	K	N	S	H
Steel	●●●*	●	●	●	●	●
Stainless	●	●●●*	●	●	●	●
Cast iron	●●	●	●●●*	●	●	●
Non-ferrous	●	●	●	●●●*	●	●
Superalloys	●	●	●	●	●●●*	●
Hard materials	●	●	●	●	●	●

Application	Chipbreaker	Designation		Corner radius	Coated							Cermet	Uncoated						
		Inch	Metric		T9115	T9125	T6120	T6130	AH630	AH645	T515	T5115	AH725	NS9530	KS05F				
Medium cutting		PM	TCMT 21.50.5 PM	TCMT110202-PM	0.008"			●	●	●	●	●							
			TCMT 21.51 PM	TCMT110204-PM	0.016"	●	●	●	●	●	●	●		●					
			TCMT 21.52 PM	TCMT110208-PM	0.031"	●	●	●	●	●	●	●		●					
			TCMT 220.5 PM	TCMT110302-PM	0.008"			●	●	●	●								
			TCMT 221 PM	TCMT110304-PM	0.016"			●	●	●	●								
			TCMT 222 PM	TCMT110308-PM	0.031"			●	●	●	●								
			TCMT 32.51 PM	TCMT16T304-PM	0.016"	●	●	●	●	●	●		●						
			TCMT 32.52 PM	TCMT16T308-PM	0.031"	●	●	●	●	●	●		●						
			TCMT 32.53 PM	TCMT16T312-PM	0.047"	●	●	●	●	●	●		●						
Finishing to medium cutting		CM	TCMT 731 CM	TCMT090204-CM	0.016"														
			TCMT 732 CM	TCMT090208-CM	0.031"														
			TCMT 21.51 CM	TCMT110204-CM	0.016"														
			TCMT 21.52 CM	TCMT110208-CM	0.031"														
			TCMT 221 CM	TCMT110304-CM	0.016"														
			TCMT 222 CM	TCMT110308-CM	0.031"														
			TCM T32.51 CM	TCMT16T304-CM	0.016"							●	●						
			TCMT 32.52 CM	TCMT16T308-CM	0.031"							●	●						
			TCMT 32.53 CM	TCMT16T312-CM	0.047"							●	●						
	SS	TCGT 21.50.5 SS	TCGT110202-SS	0.008"									●						
		TCGT 21.51 SS	TCGT110204-SS	0.016"									●						
		TCGT 21.52 SS	TCGT110208-SS	0.031"									●						
		TCGT 32.51 SS	TCGT16T304-SS	0.016"									●						
	AL	TCGT 21.50.5 AL	TCGT110202-AL	0.008"													●		
		TCGT 21.51 AL	TCGT110204-AL	0.016"													●		
		TCGT 32.50.5 AL	TCGT16T302-AL	0.008"													●		
		TCGT 32.51 AL	TCGT16T304-AL	0.016"													●		
		TCGT 32.52 AL	TCGT16T308-AL	0.031"													●		

● : Line up

Reference pages

External toolholders → **B263** Internal toolholders → **B308**
 J series toolholders → **B370**



Insert

Positive



T



Insert

TurnLine - Insert

- : Continuous cutting
- c : Light interrupted cutting
- * : Heavy interrupted cutting

POSITIVE TYPE



**Triangular, 60°
with hole
Positive 7°**

P Steel	●	●c	●c	●c	●c	●c	●c	●	●	●	●	●	●	●	●	●	●	●	●	●	●	●	●	●
M Stainless	●	●c	●c	●c	●c	●c	●c	●	●	●	●	●	●	●	●	●	●	●	●	●	●	●	●	●
K Cast iron	●	●	●	●	●	●	●	●c	●c	●	●	●	●	●	●	●	●	●	●	●	●	●	●	●
N Non-ferrous	●	●	●	●	●	●	●	●	●	●	●	●	●	●	●	●	●	●	●	●	●	●	●	●
S Superalloys	●	●	●	●	●	●	●	●	●	●	●	●	●	●	●	●	●	●	●	●	●	●	●	●
H Hard materials	●	●	●	●	●	●	●	●	●	●	●	●	●	●	●	●	●	●	●	●	●	●	●	●

Application	Chipbreaker	Designation		Corner radius	Coated				Cermet		Uncoated	
		Inch	Metric		AH725	SH725	SH730	J740	NS9530		TH10	
		-	TCGT 630 R		TCGT080102R	0.008"					●	
For external turning on small lathes (Sharp edge)		JS	TCGT 21.50.VFN JS	TCGT110200FN-JS	0.0012"	●	●					
			TCGT 21.50FN JS	TCGT110201FN-JS	0.004"	●	●					
			TCGT 21.50.5FN JS	TCGT110202FN-JS	0.008"	●	●					
			TCGT 21.51FN JS	TCGT110204FN-JS	0.016"	●	●					
On small lathes (Honed edge)		JS	TCGT 21.50N JS	TCGT110201N-JS	0.004"	●						
			TCGT 21.50.5N JS	TCGT110202N-JS	0.008"	●						
			TCGT 21.51N JS	TCGT110204N-JS	0.016"	●						
For external turning on small lathes (Sharp edge)		J08	TCGT 63V FR-J08	TCGT080200FR-J08	0.0012"	●	●				●	
			TCGT 63V FL-J08	TCGT080200FL-J08	0.0012"	●	●				●	
			TCGT 63.50FR-J08	TCGT080201FR-J08	0.004"	●	●				●	
			TCGT 63.50FL-J08	TCGT080201FL-J08	0.004"	●	●				●	
			TCGT 630.5FR-J08	TCGT080202FR-J08	0.008"	●	●				●	
			TCGT 630.5FR-J08	TCGT080202FL-J08	0.008"	●	●				●	
			TCGT 631FR-J08	TCGT080204FR-J08	0.016"	●						

● : Line up

T

Reference pages

Internal toolholders → **B308**

J series toolholders → **B370**

TurnLine - Insert

● : Continuous cutting
 ● : Light interrupted cutting
 ✳ : Heavy interrupted cutting

POSITIVE TYPE



Triangular, 60°
with hole
Positive 7°

P	Steel	●●●●	●●	●●	●									
M	Stainless	●●●●			●									
K	Cast iron			●●	●●									
N	Non-ferrous								●					
S	Superalloys													
H	Hard materials													

Application	Chipbreaker			Corner radius	Coated		Coated cermet	Cermet	Uncoated							
	Inch	Designation			SH725 J740	J9530	NS9530	TH10								
		Metric														
For external turning on small lathes (Sharp edge)	J10	TCGT 21.5 VFR-J10	TCGT110200FR-J10	0.0012"	●	●					●					
		TCGT 21.5 VFL-J10	TCGT110200FL-J10	0.0012"	●	●					●					
		TCGT 21.50 FR-J10	TCGT110201FR-J10	0.004"	●	●					●					
		TCGT 21.50 FL-J10	TCGT110201FL-J10	0.004"	●	●					●					
		TCGT 21.50.5 FR-J10	TCGT110202FR-J10	0.008"	●	●		●			●					
		TCGT 21.50.5 FL-J10	TCGT110202FL-J10	0.008"	●	●		●			●					
		TCGT 21.51 FR-J10	TCGT110204FR-J10	0.016"	●											
		TCGT 22 VFR-J10	TCGT110300FR-J10	0.0012"	●	●					●					
		TCGT 22 VFL-J10	TCGT110300FL-J10	0.0012"	●	●					●					
		TCGT 220 FR-J10	TCGT110301FR-J10	0.004"	●	●					●					
		TCGT 220 FL-J10	TCGT110301FL-J10	0.004"	●	●					●					
		TCGT 220.5 FR-J10	TCGT110302FR-J10	0.008"	●	●		●			●					
		TCGT 220.5 FL-J10	TCGT110302FL-J10	0.008"	●	●		●			●					
On small lathes (Honed edge)	J10	TCGT 220.5 R-J10	TCGT110302R-J10	0.008"			●									
		TCGT 220.5 L-J10	TCGT110302L-J10	0.008"			●									

● : Line up

Reference pages

Internal toolholders → **B308**

J series toolholders → **B370**



Insert

Positive





Insert

TurnLine - Insert

● : Continuous cutting
● : Light interrupted cutting
* : Heavy interrupted cutting

POSITIVE TYPE



Triangular, 60°
with hole
Positive 11°

P	Steel	●●●●*	●	●			●●●●			●●●●		●							
M	Stainless			●	●								●						
K	Cast iron	●●		●	●			●●●●				●●●●							●
N	Non-ferrous																		●
S	Superalloys					●													
H	Hard materials																		

Positive

Application	Chipbreaker	Designation		Corner radius	Coated				Coated cermet		Cermet		Uncoated								
		Inch	Metric		T9115	T9125	AH725	GH730	GT9530	GT720	NS9530	NS520	TH10								
Precision finishing		01	TPGT 730.5-01	TPGT090202-01	0.008"					●		●									
			TPGT 731-01	TPGT090204-01	0.016"					●		●	●		●						
			TPGT21.50.5-01	TPGT110202-01	0.008"					●		●									
			TPGT 21.51-01	TPGT110204-01	0.016"					●		●	●		●						
			TPGT 21.52-01	TPGT110208-01	0.031"							●									
			TPGT 2.520.5-01	TPGT130302-01	0.008"						●		●								
			TPGT 2.521-01	TPGT130304-01	0.016"					●		●	●		●						
			TPGT 2.522-01	TPGT130308-01	0.031"							●	●		●						
			TPGT 32.51-01	TPGT16T304-01	0.016"					●		●	●		●						
			TPGT 32.52-01	TPGT16T308-01	0.031"						●		●	●							
Finishing		PSF	TPMT 730.5 PSF	TPMT090202-PSF	0.008"			●				●									
			TPMT 731 PSF	TPMT090204-PSF	0.016"	●	●	●		●		●									
			TPMT21.50.5 PSF	TPMT110202-PSF	0.008"			●		●		●									
			TPMT 21.51 PSF	TPMT110204-PSF	0.016"	●	●	●		●		●									
			TPMT 220.5 PSF	TPMT110302-PSF	0.008"			●				●									
			TPMT 221 PSF	TPMT110304-PSF	0.016"	●	●	●		●		●									
			TPMT 2.521 PSF	TPMT130304-PSF	0.016"	●	●	●						●							
			TPMT 32.51 PSF	TPMT16T304-PSF	0.016"	●	●	●						●							
	PF	TPMT 21.51 PF	TPMT110204-PF	0.016"			●		●		●										
		TPMT 21.52 PF	TPMT110208-PF	0.031"					●		●										
		TPMT 220.5 PF	TPMT110302-PF	0.008"			●				●										
		TPMT 221 PF	TPMT110304-PF	0.016"			●		●		●										
		TPMT 2.521 PF	TPMT130304-PF	0.016"					●		●										
		TPMT 2.522 PF	TPMT130308-PF	0.031"							●										
		TPMT 32.51 PF	TPMT16T304-PF	0.016"					●		●										

● : Line up

Reference pages

Mounting hole specifications → B143

External toolholders → B258 - B260 Internal toolholders → B309 -

T

TurnLine - Insert

● : Continuous cutting
 ● : Light interrupted cutting
 * : Heavy interrupted cutting

POSITIVE TYPE



**Triangular, 60°
with hole
Positive 11°**

	P Steel	M Stainless	K Cast iron	N Non-ferrous	S Superalloys	H Hard materials
●	●	●	●	●	●	●
●	●	●	●	●	●	●
*	●	●	●	●	●	●
●	●	●	●	●	●	●
●	●	●	●	●	●	●
●	●	●	●	●	●	●
●	●	●	●	●	●	●
●	●	●	●	●	●	●

Application	Chipbreaker	Designation		Corner radius	Coated							Coated cermet	Cermet				
		Inch	Metric		T9115	T9125	T6120	T6130	AH630	AH645	AH120	AH725	GH730	GT9530	NS9530		
Finishing to light cutting		PSS	TPMT 731 PSS	TPMT090204-PSS	0.016"	●	●	●	●	●	●	●	●	●	●	●	
			TPMT 732 PSS	TPMT090208-PSS	0.031"	●	●	●	●	●	●	●	●	●	●	●	●
			TPMT 21.51 PSS	TPMT110204-PSS	0.016"	●	●	●	●	●	●	●	●	●	●	●	●
			TPMT 21.52 PSS	TPMT110208-PSS	0.031"	●	●	●	●	●	●	●	●	●	●	●	●
			TPMT 221 PSS	TPMT110304-PSS	0.016"	●	●	●	●	●	●	●	●	●	●	●	●
			TPMT 222 PSS	TPMT110308-PSS	0.031"	●	●	●	●	●	●	●	●	●	●	●	●
			TPMT 2.521 PSS	TPMT130304-PSS	0.016"	●	●	●	●	●	●	●	●	●	●	●	●
			TPMT 2.522 PSS	TPMT130308-PSS	0.031"	●	●	●	●	●	●	●	●	●	●	●	●
			TPMT 32.51 PSS	TPMT16T304-PSS	0.016"	●	●	●	●	●	●	●	●	●	●	●	●
			TPMT 32.52 PSS	TPMT16T308-PSS	0.031"	●	●	●	●	●	●	●	●	●	●	●	●
Finishing to medium cutting		PS	TPMT 730.5 PS	TPMT090202-PS	0.008"	●	●	●	●	●	●	●	●	●	●	●	
			TPMT 731 PS	TPMT090204-PS	0.016"	●	●	●	●	●	●	●	●	●	●	●	●
			TPMT 732 PS	TPMT090208-PS	0.031"	●	●	●	●	●	●	●	●	●	●	●	●
			TPMT 21.50.5 PS	TPMT110202-PS	0.008"	●	●	●	●	●	●	●	●	●	●	●	●
			TPMT 21.51 PS	TPMT110204-PS	0.016"	●	●	●	●	●	●	●	●	●	●	●	●
			TPMT 21.52 PS	TPMT110208-PS	0.031"	●	●	●	●	●	●	●	●	●	●	●	●
			TPMT 221 PS	TPMT110304-PS	0.016"	●	●	●	●	●	●	●	●	●	●	●	●
			TPMT 222 PS	TPMT110308-PS	0.031"	●	●	●	●	●	●	●	●	●	●	●	●
			TPMT 2.520.5 PS	TPMT130302-PS	0.008"	●	●	●	●	●	●	●	●	●	●	●	●
			TPMT 2.521 PS	TPMT130304-PS	0.016"	●	●	●	●	●	●	●	●	●	●	●	●
			TPMT 2.522 PS	TPMT130308-PS	0.031"	●	●	●	●	●	●	●	●	●	●	●	●
			TPMT 32.51 PS	TPMT16T304-PS	0.016"	●	●	●	●	●	●	●	●	●	●	●	●
			TPMT 32.52 PS	TPMT16T308-PS	0.031"	●	●	●	●	●	●	●	●	●	●	●	●
Finishing to light cutting		23	TPMT 730.5-23	TPMT090202-23	0.008"										●	●	
			TPMT 731-23	TPMT090204-23	0.016"		●									●	●
			TPMT 21.51-23	TPMT110204-23	0.016"		●									●	●
			TPMT 2.521-23	TPMT130304-23	0.016"		●									●	●
			TPMT 2.522-23	TPMT130308-23	0.031"		●									●	●
			TPMT 32.51-23	TPMT16T304-23	0.016"		●									●	●
			TPMT 32.52-23	TPMT16T308-23	0.031"		●									●	●

● : Line up

Reference pages

Mounting hole specifications → B143

External toolholders → B258 - B260 Internal toolholders → B309 -



Insert

Positive



T



Insert

TurnLine - Insert

- : Continuous cutting
- ◐ : Light interrupted cutting
- * : Heavy interrupted cutting

POSITIVE TYPE



**Triangular, 60°
with hole
Positive 11°**

	P	M	K	N	S	H
Steel	●	●	●	●	●	●
Stainless	●	●	●	●	●	●
Cast iron	●	●	●	●	●	●
Non-ferrous	●	●	●	●	●	●
Superalloys	●	●	●	●	●	●
Hard materials	●	●	●	●	●	●

Application	Chipbreaker	Designation		Corner radius	Coated					Coated cermet	Cermet	Uncoated				
		Inch	Metric		T9125	GH110	SH725	SH730	AH120	GT9530	NS9530	TH10	UX30			
Medium cutting		24	TPMT 731-24	TPMT090204-24	0.016"	●										
			TPMT 21.51-24	TPMT110204-24	0.016"	●										
			TPMT 21.52-24	TPMT110208-24	0.031"	●			●							
			TPMT 2.521-24	TPMT130304-24	0.016"	●										
			TPMT 2.522-24	TPMT130308-24	0.031"	●										
			TPMT 32.51-24	TPMT16T304-24	0.016"	●										
			TPMT 32.52-24	TPMT16T308-24	0.031"	●										
Finishing		W08	TPGT 5.52 R-W08	TPGT070100R-W08	0.0012"				●					●		
			TPGT 5.52 L-W08	TPGT070100L-W08	0.0012"				●					●		
			TPGT 5.520 R-W08	TPGT070101R-W08	0.004"				●					●		
			TPGT 5.520 L-W08	TPGT070101L-W08	0.004"				●					●		
			TPGT 5.520.5 R-W08	TPGT070102R-W08	0.008"				●					●		
			TPGT 5.520.5 L-W08	TPGT070102L-W08	0.008"				●					●		
			TPGT 5.521 R-W08	TPGT070104R-W08	0.016"				●					●		
			TPGT 5.521 L-W08	TPGT070104L-W08	0.016"				●					●		
			TPGT 63VL-W08	TPGT080200L-W08	0.0012"					●		●				
			TPGT 630.5L-W08	TPGT080202L-W08	0.008"		●			●		●		●	●	
			TPGT 631L-W08	TPGT080204L-W08	0.016"		●			●		●		●	●	
Finishing (Sharp edge)		W08	TPGT 5.52 FL-W08	TPGT070100FL-W08	0.0012"		●									
			TPGT 5.52 FR-W08	TPGT070100FR-W08	0.0012"		●									
			TPGT 5.520 FL-W08	TPGT070101FL-W08	0.004"		●									
			TPGT 5.520 FR-W08	TPGT070101FR-W08	0.004"		●									
			TPGT 5.520.5 FL-W08	TPGT070102FL-W08	0.008"		●									
			TPGT 5.520.5 FR-W08	TPGT070102FR-W08	0.008"		●									
			TPGT 5.521 FL-W08	TPGT070104FL-W08	0.016"		●									
			TPGT 5.521 FR-W08	TPGT070104FR-W08	0.016"		●									

● : Line up

Reference pages

Mounting hole specifications → B143

External toolholders → B258 - B260 Internal toolholders → B309 -

TurnLine - Insert

● : Continuous cutting
 ● : Light interrupted cutting
 * : Heavy interrupted cutting

POSITIVE TYPE



Triangular, 60°
with hole
Positive 11°

	P	M	K	N	S	H
Steel	● ● ●	● ● ●	● ● ●	● ● ●	● ● ●	● ● ●
Stainless	● ● ●	● ● ●	● ● ●	● ● ●	● ● ●	● ● ●
Cast iron	● ● ●	● ● ●	● ● ●	● ● ●	● ● ●	● ● ●
Non-ferrous	● ● ●	● ● ●	● ● ●	● ● ●	● ● ●	● ● ●
Superalloys	● ● ●	● ● ●	● ● ●	● ● ●	● ● ●	● ● ●
Hard materials	● ● ●	● ● ●	● ● ●	● ● ●	● ● ●	● ● ●

Application	Chipbreaker	Designation		Corner radius	Coated		Coated cermet	Cermet	Uncoated	
		Inch	Metric		GH110 GH330	GT9530	NS9530	TH10 UX30		
Application		W10	TPGH 630.5L W10	TPGH080202L-W10	0.008"	● ● ●	● ● ●	● ● ●	● ● ●	● ● ●
			TPGH 631 L W10	TPGH080204L-W10	0.016"	● ● ●	● ● ●	● ● ●	● ● ●	● ● ●
			TPGH 731 L W10	TPGH090204L-W10	0.016"	● ● ●	● ● ●	● ● ●	● ● ●	● ● ●
Application		W13	TPGH 21.51L W13	TPGH110204L-W13	0.016"	● ● ●	● ● ●	● ● ●	● ● ●	● ● ●
			TPGH 220.5L W13	TPGH110302L-W13	0.008"	● ● ●	● ● ●	● ● ●	● ● ●	● ● ●
			TPGH 221.5L W13	TPGH110304L-W13	0.016"	● ● ●	● ● ●	● ● ●	● ● ●	● ● ●
Finishing		W15	TPGT 730.5R W15	TPGT090202R-W15	0.008"	● ● ●	● ● ●	● ● ●	● ● ●	● ● ●
			TPGT730.5L W15	TPGT090202L-W15	0.008"	● ● ●	● ● ●	● ● ●	● ● ●	● ● ●
			TPGT 731R W15	TPGT090204R-W15	0.016"	● ● ●	● ● ●	● ● ●	● ● ●	● ● ●
			TPGT 731L W15	TPGT090204L-W15	0.016"	● ● ●	● ● ●	● ● ●	● ● ●	● ● ●
			TPGT 21.50.5R W15	TPGT110202R-W15	0.008"	● ● ●	● ● ●	● ● ●	● ● ●	● ● ●
			TPGT 21.50.5L W15	TPGT110202L-W15	0.008"	● ● ●	● ● ●	● ● ●	● ● ●	● ● ●
			TPGT 21.51L-W15	TPGT110204L-W15	0.016"	● ● ●	● ● ●	● ● ●	● ● ●	● ● ●
			TPGT 21.52R-W15	TPGT110208R-W15	0.031"	● ● ●	● ● ●	● ● ●	● ● ●	● ● ●
			TPGT 21.52L-W15	TPGT110208L-W15	0.031"	● ● ●	● ● ●	● ● ●	● ● ●	● ● ●
			TPGT 220.5R-W15	TPGT110302L-W15	0.008"	● ● ●	● ● ●	● ● ●	● ● ●	● ● ●
			TPGT 221L-W15	TPGT110304R-W15	0.016"	● ● ●	● ● ●	● ● ●	● ● ●	● ● ●
			TPGT 221L-W15	TPGT110304L-W15	0.016"	● ● ●	● ● ●	● ● ●	● ● ●	● ● ●
			TPGT 222L-W15	TPGT110308L-W15	0.031"	● ● ●	● ● ●	● ● ●	● ● ●	● ● ●
			TPGT 2.520.5R W15	TPGT130302R-W15	0.008"	● ● ●	● ● ●	● ● ●	● ● ●	● ● ●
			TPGT 2.520.5L W15	TPGT130302L-W15	0.008"	● ● ●	● ● ●	● ● ●	● ● ●	● ● ●
			TPGT 2.521R W15	TPGT130304R-W15	0.016"	● ● ●	● ● ●	● ● ●	● ● ●	● ● ●
			TPGT 2.521L W15	TPGT130304L-W15	0.016"	● ● ●	● ● ●	● ● ●	● ● ●	● ● ●
			TPGT 2.522L W15	TPGT130308L-W15	0.031"	● ● ●	● ● ●	● ● ●	● ● ●	● ● ●
			TPGT 32.50.5R W15	TPGT16T302R-W15	0.008"	● ● ●	● ● ●	● ● ●	● ● ●	● ● ●
			TPGT 32.50.5L W15	TPGT16T302L-W15	0.008"	● ● ●	● ● ●	● ● ●	● ● ●	● ● ●
	TPGT 32.51R W15	TPGT16T304R-W15	0.016"	● ● ●	● ● ●	● ● ●	● ● ●	● ● ●		
	TPGT 32.51L W15	TPGT16T304L-W15	0.016"	● ● ●	● ● ●	● ● ●	● ● ●	● ● ●		
	TPGT 32.52L W15	TPGT16T308L-W15	0.031"	● ● ●	● ● ●	● ● ●	● ● ●	● ● ●		

● : Line up

Reference pages

Mounting hole specifications → B143

External toolholders → B258 - B260 Internal toolholders → B309 -



Insert

Positive



T



Insert

TurnLine - Insert

● : Continuous cutting
● : Light interrupted cutting
* : Heavy interrupted cutting

POSITIVE TYPE



**Triangular, 60° with hole
Positive 11°**

P Steel	●●●*	●	*	●*	*			●●	●	●●	●		●●	●●
M Stainless			●	●	●*	*		●●	●	●●	●		●●	●●
K Cast iron	●●						●●	●	●●	●	●●	●	●●	●●
N Non-ferrous														
S Superalloys								●●	●					
H Hard materials														

Positive

Application	Chipbreaker	Designation		Corner radius	Coated										Coated cermet	Cermet				
		Inch	Metric		T9115	T9125	T6120	T6130	AH630	AH645	T515	T5115	AH120	AH725	GH330	GH730	GT9530	NS9530		
Medium cutting		PM	TPMT 731 PM	TPMT090204-PM	0.016"			●	●								●●			
			TPMT 732 PM	TPMT090208-PM	0.031"			●	●				●							
			TPMT 21.51 PM	TPMT110204-PM	0.016"	●	●	●	●	●	●			●		●		●		●
			TPMT 21.52 PM	TPMT110208-PM	0.031"	●	●	●	●	●	●		●	●		●				
			TPMT 221 PM	TPMT110304-PM	0.016"	●	●	●	●	●	●			●		●		●		●
			TPMT 222 PM	TPMT110308-PM	0.031"	●	●	●	●	●	●			●		●				
			TPMT 2.521 PM	TPMT130304-PM	0.016"		●	●	●	●	●			●						●
			TPMT 2.522 PM	TPMT130308-PM	0.031"		●	●	●	●	●			●			●			●
			TPMT 32.51 PM	TPMT16T304-PM	0.016"		●	●	●	●	●			●						●
			TPMT 32.52 PM	TPMT16T308-PM	0.031"		●	●	●	●	●			●						
			TPMT 32.53 PM	TPMT16T312-PM	0.047"		●	●	●	●	●			●						
		Finishing to medium cutting		CM	TPMT 731 CM	TPMT090204-CM	0.016"													
	TPMT 732 CM			TPMT090208-CM	0.031"															
	TPMT 21.51 CM			TPMT110204-CM	0.016"															
	TPMT 21.52 CM			TPMT110208-CM	0.031"															
	TPMT 221 CM			TPMT110304-CM	0.016"															
	TPMT 222 CM			TPMT110308-CM	0.031"															
	TPMT 2.521 CM			TPMT130304-CM	0.016"															
	TPMT 2.522 CM			TPMT130308-CM	0.031"															
	TPMT 32.51 CM			TPMT16T304-CM	0.016"							●	●							
	TPMT 32.52 CM			TPMT16T308-CM	0.031"							●	●							
	TPMT 32.53 CM			TPMT16T312-CM	0.047"							●	●							
	SS			TPGT 21.50.5 SS	TPGT110202-SS	0.008"														
		TPGT 21.51 SS	TPGT110204-SS	0.016"															●	
		TPGT 21.52.5 SS	TPGT130302-SS	0.008"															●	
		TPGT 2.520.5 SS	TPGT130304-SS	0.016"															●	
		TPGT 32.51 SS	TPGT16T304-SS	0.016"															●	

● : Line up

Reference pages

Mounting hole specifications → **B143**

External toolholders → **B258 - B260** Internal toolholders → **B309 -**

TurnLine - Insert

● : Continuous cutting
 ●c : Light interrupted cutting
 * : Heavy interrupted cutting

POSITIVE TYPE



Triangular, 60°
with hole
Positive 11°

P	Steel				●c		●c			●	●c								
M	Stainless									●	●c								
K	Cast iron	●c			●c		●c			●									
N	Non-ferrous									●									
S	Superalloys																		
H	Hard materials																		

Application	Chipbreaker	Designation		Corner radius	Coated	Coated cermet	Cermet	Uncoated		
		Inch	Metric		T5115	GT9530	NS9530	TH10	UX30	
H11		TPGH 220.5L H11	TPGH110302L-H11	0.008"		●	●			
		TPGH 221L H11	TPGH110304L-H11	0.016"		●	●			
-		TPGM 5.520.5 R	TPGM070102R	0.008"			●			
		TPGM 5.520.5 L	TPGM070102L	0.008"			●	●		
		TPGM 5.521 R	TPGM070104R	0.016"			●			
		TPGM 5.521 L	TPGM070104L	0.016"			●	●		
		TPGM 730.5R	TPGM090202R	0.008"			●			
		TPGM 730.5L	TPGM090202L	0.008"			●			
		TPGM 731L	TPGM090204L	0.016"			●			
		TPGM 21.50.5R	TPGM110202R	0.008"			●			
		TPGM 21.50.5L	TPGM110202L	0.008"			●		●	
		TPGM 21.51R	TPGM110204R	0.016"			●			
		TPGM 21.51L	TPGM110204L	0.016"			●		●	
		TPGM 220.5R	TPGM110302R	0.008"			●			
		TPGM 220.5L	TPGM110302L	0.008"			●			
		TPGM 220.5L-2	TPGM110302L-2	0.008"					●	
		TPGM 221R	TPGM110304R	0.016"			●			
		TPGM 221L	TPGM110304L	0.016"			●		●	
		TPGM 221L-2	TPGM110304L-2	0.016"					●	
		TPGM 320.5L	TPGM160302L	0.008"			●			
		TPGM 32.51R	TPGM160304R	0.016"			●			
		TPGM 32.51L	TPGM160304L	0.016"			●		●	
TPGM 32.51L-2	TPGM160304L-2	0.016"					●			
-		TPMW 21.51	TPMW110204	0.016"	●					
		TPMW 21.52	TPMW110208	0.031"	●					
		TPMW 2.521	TPMW130304	0.016"	●					
		TPMW 2.522	TPMW130308	0.031"	●					
		TPMW 32.51	TPMW16T304	0.016"	●					
		TPMW 32.52	TPMW16T308	0.031"	●					

● : Line up

Mounting hole specifications	TP*T	TPGM0701	TPGM (A) 0902~1603	TPGH									
	60°	60°	80°	81°	0701**	0802**	0902**	1102**	1103**	1303**	1603**	16T3**	
					TP*T(W)	-	0.091	0.098	0.110	0.134	0.134	-	0.173
					TPGM(A)	0.106	-	0.126	0.118	0.118	-	0.157	-
					TPGH	-	0.091	0.118	0.134	0.134	-	0.177	-

Reference pages

External toolholders → B258 - B260 Internal toolholders → B309 -



Insert

Positive



T

TurnLine - Insert

● : Continuous cutting
 ● : Light interrupted cutting
 ✱ : Heavy interrupted cutting

POSITIVE TYPE



Triangular, 60°
 without hole
 Positive 11°

	P	M	K	N	S	H
Steel	●●●✱					
Stainless		●				
Cast iron	●●		●●			
Non-ferrous				●		
Superalloys					●	
Hard materials						

Application	Chipbreaker	Designation		Corner radius	Coated				Cermet		Uncoated	
		Inch	Metric		T9115	T9125	T5115	AH725	NS9530	TH10		
Finishing to medium cutting		PS	TPMR 221 PS	TPMR110304-PS	0.016"	●						
			TPMR 222 PS	TPMR110308-PS	0.031"	●						
			TPMR 331 PS	TPMR160304-PS	0.016"	●						
			TPMR 332 PS	TPMR160308-PS	0.031"	●						
Finishing to medium cutting		23	TPMR 221 TN23	TPMR110304-23	0.016"	●●			●			
			TPMR 222 TN23	TPMR110308-23	0.031"	●			●	●		
			TPMR 321 TN23	TPMR160304-23	0.016"	●●			●	●		
			TPMR 322 TN23	TPMR160308-23	0.031"	●			●			
Medium cutting		24	TPMR 221-24	TPMR110304-24	0.016"	●			●			
			TPMR 222-24	TPMR110308-24	0.031"	●			●			
			TPMR 321-24	TPMR160304-24	0.016"	●●		●	●			
			TPMR 322-24	TPMR160308-24	0.031"	●●			●			
Finishing to medium cutting		CM	TPMR 221 CM	TPMR110304-CM	0.016"		●					
			TPMR 222 CM	TPMR110308-CM	0.031"		●					
			TPMR 321 CM	TPMR160304-CM	0.016"		●					
			TPMR 322 CM	TPMR160308-CM	0.031"		●					
			TPMR 323 CM	TPMR160312-CM	0.047"		●					

● : Line up



Insert



Positive



T

Reference pages

External toolholders → B258 - B260 Internal toolholders → B335

- : Continuous cutting
- : Light interrupted cutting
- * : Heavy interrupted cutting



Insert

TurnLine - Insert

POSITIVE TYPE



**Triangular, 60°
without hole
Positive 11°**

	P Steel	M Stainless	K Cast iron	N Non-ferrous	S Superalloys	H Hard materials
●	● ● ● ● ●	● ● ● ● ●	● ● ● ● ●	● ● ● ● ●	● ● ● ● ●	● ● ● ● ●
●	● ● ● ● ●	● ● ● ● ●	● ● ● ● ●	● ● ● ● ●	● ● ● ● ●	● ● ● ● ●
*	● ● ● ● ●	● ● ● ● ●	● ● ● ● ●	● ● ● ● ●	● ● ● ● ●	● ● ● ● ●
*	● ● ● ● ●	● ● ● ● ●	● ● ● ● ●	● ● ● ● ●	● ● ● ● ●	● ● ● ● ●
●	● ● ● ● ●	● ● ● ● ●	● ● ● ● ●	● ● ● ● ●	● ● ● ● ●	● ● ● ● ●
●	● ● ● ● ●	● ● ● ● ●	● ● ● ● ●	● ● ● ● ●	● ● ● ● ●	● ● ● ● ●
●	● ● ● ● ●	● ● ● ● ●	● ● ● ● ●	● ● ● ● ●	● ● ● ● ●	● ● ● ● ●
●	● ● ● ● ●	● ● ● ● ●	● ● ● ● ●	● ● ● ● ●	● ● ● ● ●	● ● ● ● ●
●	● ● ● ● ●	● ● ● ● ●	● ● ● ● ●	● ● ● ● ●	● ● ● ● ●	● ● ● ● ●
●	● ● ● ● ●	● ● ● ● ●	● ● ● ● ●	● ● ● ● ●	● ● ● ● ●	● ● ● ● ●

Application	Chipbreaker	Designation		Corner radius	Coated				Cermet		Uncoated		Ceramics		
		Inch	Metric		T5115	GH110	AH120	T3130	NS9530	NS740	TH10	UX30	LX21	LX11	
	-	TPGR 220.5L	TPGR110302L	0.008"					●						
		TPGR 221L	TPGR110304L	0.016"					●						
		TPGR 321R	TPGR160304R	0.016"					●						
		TPGR 321L	TPGR160304L	0.016"					●						
		TPGR 322L	TPGR160308L	0.031"					●						
	-	TPU 221	TPMN110304	0.016"	●						●	●			
		TPU 222	TPMN110308	0.031"	●						●	●			
		TPU 321	TPMN160304	0.016"	●	●	●				●	●			
		TPU 322	TPMN160308	0.031"	●	●	●				●	●			
		TPU 323	TPMN160312	0.047"	●										
		TPU 431	TPMN220404	0.016"				●							
		TPU 432	TPMN220408	0.031"			●	●				●			
		TPU 433	TPMN220412	0.047"								●			
	-	TPG 220.5	TPGN110302	0.008"							●				
		TPG 221	TPGN110304	0.016"	●					●				●	●
		TPG 222	TPGN110308	0.031"						●				●	
		TPG 320.5	TPGN160302	0.008"							●				
	TPG 321	TPGN160304	0.016"	●					●	●			●		
	TPG 322	TPGN160308	0.031"	●					●	●			●		
	TPG 323	TPGN160312	0.047"						●				●		
	TPG 431	TPGN220404	0.016"						●						
	TPG 432	TPGN220408	0.031"						●						
	TPG 433	TPGN220412	0.047"						●						



Positive

● : Line up

Reference pages

External toolholders → B258 - B260 Internal toolholders → B335



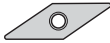

TurnLine - Insert

● : Continuous cutting
 ● : Light interrupted cutting
 * : Heavy interrupted cutting

POSITIVE TYPE

 Rhombic, 35°
with hole
Positive 5°

	P	M	K	N	S	H														
Steel	●●●*	●	●	●	●	●	●	●	●	●	●	●	●	●	●	●	●	●	●	●
Stainless	●	●	●	●	●	●	●	●	●	●	●	●	●	●	●	●	●	●	●	●
Cast iron	●●	●	●	●	●	●	●	●	●	●	●	●	●	●	●	●	●	●	●	●
Non-ferrous	●	●	●	●	●	●	●	●	●	●	●	●	●	●	●	●	●	●	●	●
Superalloys	●	●	●	●	●	●	●	●	●	●	●	●	●	●	●	●	●	●	●	●
Hard materials	●	●	●	●	●	●	●	●	●	●	●	●	●	●	●	●	●	●	●	●

Application	Chipbreaker	Designation		Corner radius	Coated								Coated cermet	Cermet									
		Inch	Metric		T9115	T9125	T6120	T6130	AH630	AH645	T515	T5115	AH120	AH725	GT9530	NS9530							
Finishing		PSF	VBMT 220.5 PSF	VBMT110302-PSF	0.008"																		
			VBMT 221 PSF	VBMT110304-PSF	0.016"	●	●							●		●							
			VBMT 330.5 PSF	VBMT160402-PSF	0.008"										●		●						
			VBMT 331 PSF	VBMT160404-PSF	0.016"	●	●								●		●						
		PF	VBMT 220.5 PF	VBMT110302-PF	0.008"										●		●						
Finishing to light cutting			VBMT 221 PSS	VBMT110304-PSS	0.016"	●	●	●	●	●	●			●		●							
			VBMT 222 PSS	VBMT110308-PSS	0.031"	●	●	●	●	●	●			●		●							
			VBMT 331 PSS	VBMT160404-PSS	0.016"	●	●	●	●	●	●			●		●		●					
			VBMT 332 PSS	VBMT160408-PSS	0.031"	●	●	●	●	●	●			●		●		●					
			VBMT 333 PSS	VBMT160412-PSS	0.047"	●	●							●									
Finishing to medium cutting			VBMT 220.5 PS	VBMT110302-PS	0.008"	●	●	●	●	●	●			●		●							
			VBMT 221 PS	VBMT110304-PS	0.016"	●	●	●	●	●	●			●		●		●					
			VBMT 222 PS	VBMT110308-PS	0.031"	●	●	●	●	●	●			●		●		●					
			VBMT 330.5 PS	VBMT160402-PS	0.008"	●	●	●	●	●	●			●		●		●					
			VBMT 331 PS	VBMT160404-PS	0.016"	●	●	●	●	●	●			●		●		●					
			VBMT 332 PS	VBMT160408-PS	0.031"	●	●	●	●	●	●			●		●		●					
Medium cutting		24	VBMT 331-24	VBMT160404-24	0.016"	●	●													●			
			VBMT 332-24	VBMT160408-24	0.031"	●	●														●		
Finishing to medium cutting			VBMT 221 CM	VBMT110304-CM	0.016"																		
			VBMT 222 CM	VBMT110308-CM	0.031"																		
			VBMT 331 CM	VBMT160404-CM	0.016"																		
			VBMT 332 CM	VBMT160408-CM	0.031"																		
			VBMT 333 CM	VBMT160412-CM	0.047"																		

● : Line up

Reference pages

External toolholders → B229 Internal toolholders → B306 -
 J series toolholders → B371 - B374



Insert

Positive





Insert

TurnLine - Insert

● : Continuous cutting
 ● : Light interrupted cutting
 * : Heavy interrupted cutting

POSITIVE TYPE

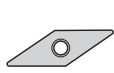

**Rhombic, 35°
 with hole
 Positive 5°**

P Steel	●	●	●	●	●	●	●	●	●	●	●	●	●	●	●	●	●	●
M Stainless	●	●	●	●	●	●	●	●	●	●	●	●	●	●	●	●	●	●
K Cast iron	●	●	●	●	●	●	●	●	●	●	●	●	●	●	●	●	●	
N Non-ferrous	●	●	●	●	●	●	●	●	●	●	●	●	●	●	●	●	●	
S Superalloys	●	●	●	●	●	●	●	●	●	●	●	●	●	●	●	●	●	
H Hard materials																		

Positive

Application	Chipbreaker	Designation		Corner radius	Coated				Coated cermet	Cermet	Uncoated							
		Inch	Metric		AH725	SH725	SH730	J740	J9530	NS9530	TH10							
For external turning on small lathes (Sharp edge)		JS	VBGT 22 FN JS	VBGT110300FN-JS	0.0012"	●	●											
			VBGT 220 FN JS	VBGT110301FN-JS	0.004"	●	●											
			VBGT 220.5 FN JS	VBGT110302FN-JS	0.008"	●	●											
			VBGT 221 FN JS	VBGT110304FN-JS	0.016"	●	●											
For external turning on small lathes		JS	VBGT 220 N JS	VBGT110301N-JS	0.004"	●												
			VBGT 220.5 N JS	VBGT110302N-JS	0.008"	●												
			VBGT 221 N JS	VBGT110304N-JS	0.016"	●												
For external turning on small lathes (Sharp edge)		J10	VBGT 22 FR J10	VBGT110300FR-J10	0.0012"	●		●					●					
			VBGT 22 FL J10	VBGT110300FL-J10	0.0012"	●		●						●				
			VBGT 220 FR J10	VBGT110301FR-J10	0.004"	●		●			●			●				
			VBGT 220 FL J10	VBGT110301FL-J10	0.004"	●		●			●			●				
			VBGT 220.5 FR J10	VBGT110302FR-J10	0.008"	●		●			●			●				
			VBGT 220.5 FL J10	VBGT110302FL-J10	0.008"	●		●			●			●				
			VBGT 221 FR J10	VBGT110304FR-J10	0.016"	●		●			●			●				
			VBGT 221 FL J10	VBGT110304FL-J10	0.016"	●		●			●			●				
On small lathes (Honed edge)		J10	VBGT 220.5R J10	VBGT110302R-J10	0.008"					●								
			VBGT 220.5L J10	VBGT110302L-J10	0.008"					●								
			VBGT 221R J10	VBGT110304R-J10	0.016"					●								
			VBGT 221L J10	VBGT110304L-J10	0.016"					●								

● : Line up

Reference pages

External toolholders → **B229** Internal toolholders → **B306 -**
 J series toolholders → **B371 - B374**



TurnLine - Insert

● : Continuous cutting
 ● : Light interrupted cutting
 * : Heavy interrupted cutting

POSITIVE TYPE

 Rhombic, 35°
 with hole
 Positive 7°

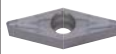
	P	M	K	N	S	H
Steel	●●●*	●	●	●	●	●
Stainless	●	●●●*	●	●	●	●
Cast iron	●●	●	●●●*	●	●	●
Non-ferrous	●	●	●	●●●*	●	●
Superalloys	●	●	●	●	●●●*	●
Hard materials	●	●	●	●	●	●

Application	Chipbreaker	Designation		Corner radius	Coated										Coated cermet	Cermet				
		Inch	Metric		T9115	T9125	T6120	T6130	AH630	AH645	AH120	AH725	AH8005	AH8015	AH905	GT9530	NS9530			
Finishing		PSF	VCMT 630.5 PSF	VCMT080202-PSF	0.008"													●	●	
			VCMT 631 PSF	VCMT080204-PSF	0.016"	●	●					●						●	●	
			VCMT 220.5 PSF	VCMT110302-PSF	0.008"							●								
			VCMT 221 PSF	VCMT110304-PSF	0.016"	●	●					●								
			VCMT 331 PSF	VCMT160404-PSF	0.016"	●	●					●	●	●	●			●	●	
			VCMT 332 PSF	VCMT160408-PSF	0.031"	●	●					●	●	●	●			●	●	
		PF	VCMT 630.5 PF	VCMT080202-PF	0.008"													●	●	
			VCMT 631 PF	VCMT080204-PF	0.016"													●	●	
		VCMT 331 PF	VCMT160404-PF	0.016"													●	●		
		VCMT 332 PF	VCMT160408-PF	0.031"													●	●		
Finishing to light cutting		PSS	VCMT 221 PSS	VCMT110304-PSS	0.016"	●	●	●	●	●	●							●	●	
			VCMT 222 PSS	VCMT110308-PSS	0.031"	●	●	●	●	●	●							●	●	
			VCMT 331 PSS	VCMT160404-PSS	0.016"	●	●	●	●	●	●	●	●	●	●			●	●	
			VCMT 332 PSS	VCMT160408-PSS	0.031"	●	●	●	●	●	●	●	●	●	●			●	●	
Finishing to medium cutting		PS	VCMT 220.5 PS	VCMT110302-PS	0.008"	●	●	●	●	●	●							●	●	
			VCMT 221 PS	VCMT110304-PS	0.016"	●	●	●	●	●	●							●	●	
			VCMT 222 PS	VCMT110308-PS	0.031"	●	●	●	●	●	●							●	●	
			VCMT 331 PS	VCMT160404-PS	0.016"	●	●	●	●	●	●	●	●	●	●			●	●	
			VCMT 332 PS	VCMT160408-PS	0.031"	●	●	●	●	●	●	●	●	●	●			●	●	

● : Line up

Reference pages

External toolholders → B262 - Internal toolholders → B306 -
 TungCap → F011



Insert

Positive





Insert

TurnLine - Insert

- : Continuous cutting
- : Light interrupted cutting
- * : Heavy interrupted cutting

POSITIVE TYPE

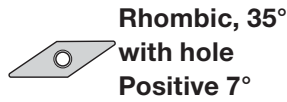

P Steel	●●●●*								●●							
M Stainless	●	●						●		●						
K Cast iron	●●		●●	●					●●		●					
N Non-ferrous													●			
S Superalloys						●	●	●					●			
H Hard materials																

Application	Chipbreaker	Designation		Corner radius	Coated						Cermet	Uncoated					
		Inch	Metric		T9115	T9125	T515	T5115	AH8005	AH8015	AH905	NS9530	KS05F				
Finishing to medium cutting		24	VCMT 331-24	VCMT160404-24	0.016"	●	●						●				
			VCMT 332-24	VCMT160408-24	0.031"	●	●							●			
		CM	VCMT 631 CM	VCMT080204-CM	0.016"				●								
			VCMT 331 CM	VCMT160404-CM	0.016"		●	●									
			VCMT 332 CM	VCMT160408-CM	0.031"		●	●									
Medium cutting		All-round	VCMT 331	VCMT160404	0.016"					●	●	●					
			VCMT 332	VCMT160408	0.031"					●	●	●					
			VCMT 333	VCMT160412	0.047"					●	●	●					
Finishing to medium cutting		AL	VCGT 331 AL	VCGT160404-AL	0.016"									●			
			VCGT 332 AL	VCGT160408-AL	0.031"										●		
			VCGT 333 AL	VCGT160412-AL	0.047"											●	
			VCGT 43.56 AL	VCGT220520-AL	0.079"											●	
			VCGT 43.58 AL	VCGT220530-AL	0.118"											●	

● : Line up

Reference pages

VC*T... : External toolholders → **B262** -, Internal toolholders → **B306** -

VPET... : J series toolholders → **B375**

POSITIVE TYPE

**Rhombic, 35°
with hole
Positive 11°**



P	Steel	●●●●
M	Stainless	●●●●
K	Cast iron	
N	Non-ferrous	
S	Superalloys	●●
H	Hard materials	

Application	Chipbreaker	Designation		Corner radius	Coated	
		Inch	Metric		SH725	SH730
For external turning on small lathes (Sharp edge)	JPP	VPET 63X MFR-JPP	VPET0802008MFR-JPP	<0.0031**	●	●
		VPET 63X MFL-JPP	VPET0802008MFL-JPP	<0.0031**	●	●
		VPET 630.2 MFR-JPP	VPET080201MFR-JPP	<0.004**	●	●
		VPET 630.2 MFL-JPP	VPET080201MFL-JPP	<0.004**	●	●
		VPET 630.4 MFR-JPP	VPET0802018MFR-JPP	<0.007**	●	●
		VPET 630.4 MFL-JPP	VPET0802018MFL-JPP	<0.007**	●	●
		VPET 630.5 MFR-JPP	VPET080202MFR-JPP	<0.008**	●	●
		VPET 630.5 MFL-JPP	VPET080202MFL-JPP	<0.008**	●	●
		VPET 22X MFR-JPP	VPET1103008MFR-JPP	<0.0031**	●	●
		VPET 22X MFL-JPP	VPET1103008MFL-JPP	<0.0031**	●	●
		VPET 220.2 MFR-JPP	VPET110301MFR-JPP	<0.004**	●	●
		VPET 220.2 MFL-JPP	VPET110301MFL-JPP	<0.004**	●	●
		VPET 220.4 MFR-JPP	VPET1103018MFR-JPP	<0.007**	●	●
		VPET 220.4 MFL-JPP	VPET1103018MFL-JPP	<0.007**	●	●
		VPET 220.5 MFR-JPP	VPET110302MFR-JPP	<0.008**	●	●
	VPET 220.5 MFL-JPP	VPET110302MFL-JPP	<0.008**	●	●	
	JRP	VPET 63X MFR-JRP	VPET0802008MFR-JRP	<0.0031**	●	●
		VPET 63X MFL-JRP	VPET0802008MFL-JRP	<0.0031**	●	●
		VPET 630.2 MFR-JRP	VPET080201MFR-JRP	<0.004**	●	●
		VPET 630.2 MFL-JRP	VPET080201MFL-JRP	<0.004**	●	●
		VPET 630.4 MFR-JRP	VPET0802018MFR-JRP	<0.007**	●	●
		VPET 630.4 MFL-JRP	VPET0802018MFL-JRP	<0.007**	●	●
		VPET 630.5 MFR-JRP	VPET080202MFR-JRP	<0.008**	●	●
		VPET 630.5 MFL-JRP	VPET080202MFL-JRP	<0.008**	●	●
		VPET 22X MFR-JRP	VPET1103008MFR-JRP	<0.0031**	●	●
		VPET 22X MFL-JRP	VPET1103008MFL-JRP	<0.0031**	●	●
		VPET 220.2 MFR-JRP	VPET110301MFR-JRP	<0.004**	●	●
		VPET 220.2 MFL-JRP	VPET110301MFL-JRP	<0.004**	●	●
VPET 220.4 MFR-JRP		VPET1103018MFR-JRP	<0.007**	●	●	
VPET 220.4 MFL-JRP		VPET1103018MFL-JRP	<0.007**	●	●	
VPET 220.5 MFR-JRP		VPET110302MFR-JRP	<0.008**	●	●	
VPET 220.5 MFL-JRP	VPET110302MFL-JRP	<0.008**	●	●		
For external turning on small lathes (Sharp edge)	JSP	VPET 63X MFN-JSP	VPET0802008MFN-JSP	<0.0031**	●	●
		VPET 630.2 MFN-JSP	VPET080201MFN-JSP	<0.004**	●	●
		VPET 630.4 MFN-JSP	VPET0802018MFN-JSP	<0.007**	●	●
		VPET 630.5 MFN-JSP	VPET080202MFN-JSP	<0.008**	●	●
		VPET 22X MFN-JSP	VPET1103008MFN-JSP	<0.0031**	●	●
		VPET 220.2 MFN-JSP	VPET110301MFN-JSP	<0.004**	●	●
		VPET 220.4 MFN-JSP	VPET1103018MFN-JSP	<0.007**	●	●
		VPET 220.5 MFN-JSP	VPET110302MFN-JSP	<0.008**	●	●

* Corner radius has minus tolerance.

Note: See page B051 for chipbreaker descriptions.

● : Line up



Insert

Positive



● : Continuous cutting
 ●● : Light interrupted cutting
 ※ : Heavy interrupted cutting



Insert

TurnLine - Insert

POSITIVE TYPE DOUBLE-SIDED



**Rhombic, 35°
with hole**

P	Steel	●●																					
M	Stainless	●●																					
K	Cast iron																						
N	Non-ferrous																						
S	Superalloys																						
H	Hard materials																						

Application	Chipbreaker	Designation		Corner radius	Coated																			
		Inch	Metric		SH725																			
Finishing (Sharp edge)		JRP	VXGU 73.50 MFRE-JRP	VXGU09T201MFRE-JRP	<0.004**	●●																		
			VXGU 73.50 MFLE-JRP	VXGU09T201MFLE-JRP	<0.004**	●●																		
			VXGU 73.50.5 MFRE-JRP	VXGU09T202MFRE-JRP	<0.008**	●●																		
			VXGU 73.50.5 MFLE-JRP	VXGU09T202MFLE-JRP	<0.008**	●●																		

* Corner radius has minus tolerance.

● : Line up

Positive

POSITIVE TYPE



**Trigon, 80°
with hole
Positive 11°**

P	Steel	●●●●	●●●●	●●●●																			
M	Stainless		●●	●●																			
K	Cast iron	●●	●●	●●																			
N	Non-ferrous																						
S	Superalloys			●●																			
H	Hard materials																						

Application	Chipbreaker	Designation		Corner radius	Coated																	
		Inch	Metric		T9115	T9125	AH120															
Heavy cutting		-	WPMT090725ZPR-ML	0.098"	●●●																	
		-	WPMT090725ZPL-ML	0.098"	●●●																	

● : Line up



Reference pages

VXGU... : External toolholders → **B194 - B197, B228**

WPMT... : External toolholders → **B275**



Insert

TurnLine - Insert

- : Continuous cutting
- : Light interrupted cutting
- : Heavy interrupted cutting

POSITIVE TYPE DOUBLE-SIDED



**Trigon, 80°
with hole**

	P	M	K	N	S	H
Steel	●●●●	●●●●	●●●●	●●●●	●●●●	●●●●
Stainless	●●●●	●●●●	●●●●	●●●●	●●●●	●●●●
Cast iron	●●●●	●●●●	●●●●	●●●●	●●●●	●●●●
Non-ferrous	●●●●	●●●●	●●●●	●●●●	●●●●	●●●●
Superalloys	●●●●	●●●●	●●●●	●●●●	●●●●	●●●●
Hard materials	●●●●	●●●●	●●●●	●●●●	●●●●	●●●●

Positive

Application	Chipbreaker	Designation		Corner radius	Coated		Coated cermet	Cermet	Uncoated
		Inch	Metric		AH725	SH725	GT9530	NS9530	KS05F
Finishing to medium cutting (Sharp edge)		JTS	WXGU 220 MFR-JTS	WXGU040301MFR-JTS	<0.004**	●			
			WXGU 220 MFL-JTS	WXGU040301MFL-JTS	<0.004**	●			
			WXGU 220.5 MFR-JTS	WXGU040302MFR-JTS	<0.008**	●			
			WXGU 220.5 MFL-JTS	WXGU040302MFL-JTS	<0.008**	●			
Finishing to medium cutting		JTS	WXGU 220 MR-JTS	WXGU040301MR-JTS	<0.004**	●			
			WXGU 220 ML-JTS	WXGU040301ML-JTS	<0.004**	●			
			WXGU 220.5 MR-JTS	WXGU040302MR-JTS	<0.008**	●			
			WXGU 220.5 ML-JTS	WXGU040302ML-JTS	<0.008**	●			
Finishing (Low cutting force) (Sharp edge)		JSS	WXGU 220 MFR-JSS	WXGU040301MFR-JSS	<0.004**	●			
			WXGU 220 MFL-JSS	WXGU040301MFL-JSS	<0.004**	●			
			WXGU 220.5 MFR-JSS	WXGU040302MFR-JSS	<0.008**	●			
			WXGU 220.5 MFL-JSS	WXGU040302MFL-JSS	<0.008**	●			
Finishing (Low cutting force)		JSS	WXGU 220 MR-JSS	WXGU040301MR-JSS	<0.004**	●			
			WXGU 220 ML-JSS	WXGU040301ML-JSS	<0.004**	●			
			WXGU 220.5 MR-JSS	WXGU040302MR-JSS	<0.008**	●			
			WXGU 220.5 ML-JSS	WXGU040302ML-JSS	<0.008**	●			
Finishing to medium cutting		TS	WXGU 220.5 R TS	WXGU040302R-TS	0.008"	●	●	●	●
			WXGU 220.5 L TS	WXGU040302L-TS	0.008"	●	●	●	●
			WXGU 221 R TS	WXGU040304R-TS	0.016"	●	●	●	●
			WXGU 221 L TS	WXGU040304L-TS	0.016"	●	●	●	●
			WXGU 222 R TS	WXGU040308R-TS	0.031"	●	●	●	●
			WXGU 222 L TS	WXGU040308L-TS	0.031"	●	●	●	●
Finishing (Wiper)		TSW	WXGU 221 R TSW	WXGU040304R-TSW	0.016"	●	●	●	
			WXGU 221 L TSW	WXGU040304L-TSW	0.016"	●	●	●	
			WXGU 222 R TSW	WXGU040308R-TSW	0.031"	●	●	●	
			WXGU 222 L TSW	WXGU040308L-TSW	0.031"	●	●	●	
Finishing (Low cutting force)		SS	WXGU 220.5 R SS	WXGU040302R-SS	0.008"	●	●	●	●
			WXGU 220.5 L SS	WXGU040302L-SS	0.008"	●	●	●	●
			WXGU 221 R SS	WXGU040304R-SS	0.016"	●	●	●	●
			WXGU 221 L SS	WXGU040304L-SS	0.016"	●	●	●	●

* Corner radius has minus tolerance.

Reference pages

External toolholders → **B190, B191, B227**

Internal toolholders → **B288**

● : Line up



TurnLine - Insert

- : Continuous cutting
- c : Light interrupted cutting
- * : Heavy interrupted cutting

POSITIVE TYPE

 **Rhombic, 25°**
with hole
Positive 7°

	P	M	K	N	S	H
Steel	●*					
Stainless		●				
Cast iron			●c			
Non-ferrous				●		
Superalloys					●	
Hard materials						●

Application	Chipbreaker	Designation		Corner radius	Coated	Coated cermet													
		Inch	Metric		T9125	GT9530													
Finishing to medium cutting		-	YWMT11T202-ZF	0.008"	●	●													
			YWMT11T204-ZF	0.016"	●	●													
			YWMT16T302-ZF	0.008"	●	●													
			YWMT16T304-ZF	0.016"	●	●													
			YWMT16T308-ZF	0.031"	●	●													
		-	YWMT11T204-ZM	0.016"	●	●													
			YWMT16T304-ZM	0.016"	●	●													
			YWMT16T308-ZM	0.031"	●	●													

● : Line up



Insert

Positive



Reference pages

External toolholders → **B231** -
Internal toolholders → **B329**

● : Continuous cutting
 ● : Light interrupted cutting
 * : Heavy interrupted cutting



Insert

TurnLine - Insert

POSITIVE TYPE



**Front turning
Insert**

	P Steel	M Stainless	K Cast iron	N Non-ferrous	S Superalloys	H Hard materials
●	●	●	●	●		
●	●	●	●	●		
●				●		
●						
●						

Application	Chipbreaker		Designation	Corner radius	Coated		Uncoated	
	Inch	Metric			J740	TH10		
Front turning	-	-	JXFR8000F	0.0012"	●	●		
	-	-	JXFR8010F	0.004"	●	●		



**Reverse turning
Insert**

	P Steel	M Stainless	K Cast iron	N Non-ferrous	S Superalloys	H Hard materials
●	●	●	●	●		
●	●	●	●	●		
●				●		
●						
●						

Application	Chipbreaker		Designation	Corner radius	Coated		Uncoated	
	Inch	Metric			J740	TH10		
Reverse turning	-	-	JXRR8000F	0.0012"	●	●		
	-	-	JXRR8010F	0.004"	●	●		

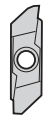

**Back turning
Insert**

	P Steel	M Stainless	K Cast iron	N Non-ferrous	S Superalloys	H Hard materials
●	●	●	●	●		
●	●	●	●	●		
●				●		
●						
●						

Application	Chipbreaker		Designation	Corner radius	Coated		Uncoated	
	Inch	Metric			J740	TH10		
Back turning	-	-	JXBR8000F	0.0012"	●	●		
	-	-	JXBL8000F	0.0012"	●	●		
	-	-	JXBR8005F	0.002"	●	●		
	-	-	JXBL8005F	0.002"	●	●		
	-	-	JXBR8005	0.002"	●			
	-	-	JXBL8005	0.002"	●			
	-	-	JXBR8010F	0.004"	●	●		
	-	-	JXBL8010F	0.004"	●	●		
	-	-	JXBR8010	0.004"	●			
	-	-	JXBL8010	0.004"	●			
	-	-	JXBR8015F	0.006"	●	●		
	-	-	JXBL8015F	0.006"	●	●		
	-	-	JXBR8015	0.006"	●			
	-	-	JXBL8015	0.006"	●			

OTHERS

● : Line up

TurnLine - Insert

● : Continuous cutting
 ● : Light interrupted cutting
 ✳ : Heavy interrupted cutting

POSITIVE TYPE



Insert

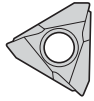

Back turning
Insert

Application	Chipbreaker	Designation		Corner radius	Coated		Coated cermet	Cermet	Uncoated										
		Inch	Metric		SH725	J740	J9530	NS9530	TH10										
Back turning 	-	-	JTBR3000F	0.0012"	●	●			●										
		-	JTBL3000F	0.0012"	●	●			●										
		-	JTBR3005F	0.002"	●	●			●										
		-	JTBL3005F	0.002"	●	●			●										
		-	JTBR3005	0.002"	●		●												
		-	JTBL3005	0.002"	●	●													
		-	JTBR3010F	0.004"	●	●			●		●								
		-	JTBL3010F	0.004"	●	●			●		●								
		-	JTBR3010	0.004"	●		●												
		-	JTBL3010	0.004"	●	●													
		-	JTBR3015F	0.006"	●	●													
		-	JTBL3015F	0.006"	●	●													

Positive



Back turning
Insert

Application	Chipbreaker	Designation		Corner radius	Coated		Coated cermet	Cermet	Uncoated										
		Inch	Metric		SH725	J740	J9530	NS9530	TH10										
Back turning 	-	-	J10ER005BF	0.002"	●	●		●	●										
		-	J10EL005BF	0.002"	●	●			●										
		-	J10ER005B	0.002"	●		●												
		-	J10EL005B	0.002"	●	●													
		-	J10ER010BF	0.004"	●	●			●		●								
		-	J10EL010BF	0.004"	●	●					●								
		-	J10ER010B	0.004"	●		●												
		-	J10EL010B	0.004"	●	●													
		-	J10EL015BF	0.006"	●	●													
		-	J10ER015BF	0.006"	●	●													

OTHERS

Reference pages

- JXF..., JXR... : J series toolholders → **B379**
- JXB... : J series toolholders → **B380**
- JTB... : J series toolholders → **B381**
- J10E... : J series toolholders → **B383**

● : Line up



Insert

TurnLine - Insert

● : Continuous cutting
 ● : Light interrupted cutting
 * : Heavy interrupted cutting

POSITIVE TYPE



**Back turning
Insert**

P Steel	●																		
M Stainless	●																		
K Cast iron	●																		
N Non-ferrous	●																		
S Superalloys																			
H Hard materials																			

Application	Chipbreaker	Designation		Corner radius	Uncoated																
		Inch	Metric		TH10																
Back turning		-	10ER100B	0.0012"	●																
		-	10EL100B	0.0012"	●																
		-	10ER150B	0.0012"	●																
		-	10EL150B	0.0012"	●																
		-	10ER300	-	●																
		-	10EL300	-	●																

● : Line up

Positive

OTHERS

Reference pages

J series toolholders → **B383**

MEMO



Insert

Positive



Insert

TurnLine - Designation System for T-CBN (PCBN) Inserts

Multi-Corner type

2 **QP** - **CNGA120404** **-L**

1 Number of corners

2 Type

QP	CBN Inserts
----	-------------

3 ISO symbol

4 Special feature & chipbreaker

Without	Standard honing
-L	Light honing angle Wear resistance priority
-H	Heavy honing angle Impact resistance priority
-W	Wiper type insert
-W□	Round wiper type insert
-F	Sharp edge
-HF	With chipbreaker
-HM	With chipbreaker

PCD / CBN

Multi-Corner type (10 inserts packing)

T **2** **QP** - **CNGA120408**

1 "T" shows 10 inserts packing.

For general turning

TNGA160402 - **QBN**

1 ISO symbol

2 CBN inserts

T-CBN (PCBN tipped) grooving Inserts

XG **R** **63** **10** **S** - **QBN**

1 For grooving tool GX-type

2 Hand of Insert

L	Left
R	Right

3 Groove width (mm)

10	1.0
15	1.5

4 Corner radius: r_{ϵ} (mm)

S	0.2
---	-----

5 CBN inserts

For **TUNG**CUT

S **G** **N** **200** - **020**

1 Number of edge

S	Single corner
---	---------------

2 Application

G	Grooving
---	----------

3 For use

N	Non breaker
---	-------------

4 Groove width (mm)

200	2.0
-----	-----

5 Corner radius: r_{ϵ} (mm)

020	0.2
-----	-----

TurnLine - Designation System for T-DIA (PCD) Inserts

Inserts for turning



Insert



TurnLine - T-CBN Inserts GNGA type

GNGA

PCD / CBN

Negative relief angle, G class, rhombic insert with 70° corner angle .

New shape CBN insert for general turning

- 70° corner angle makes large clearance between insert and workpiece.
- Large clearance reduces the cutting force and wear on edge, and provides smooth chip flow to prevent scratches on machined surface by chips.



High versatility

- Standard toolholder for ISO CN**43* insert is available.
- No need offsets compared to CN**43* insert, due to same geometry of cutting edge position.
- Double sided insert with 2 cutting edges.
- 4 types of CBN grades are available for machining of a wide range of materials.



Tungaloy B161



Insert

H T-CBN series for machining hardened steels and hard materials

Application area

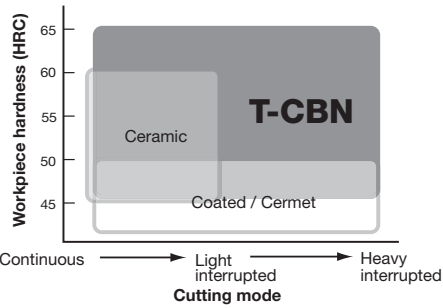

Necessity of PCBN grades

The condition necessary to cut the work

Material is:
Hardness of tool \geq Hardness of tool X 3

- Hardened steel (60HRC) \rightarrow 700 Hv
- PCBN (BX360) \rightarrow 3300 Hv
- Cemented carbide \rightarrow 1600 Hv

Effects of grain size of CBN on surface roughness and cutting speed

[Fine-grained CBN]

[Rough-grained CBN]

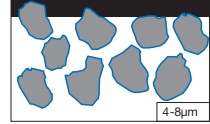
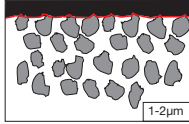

Fine grained PCBN provided with sharp cutting edge.

Rough grained PCBN. CBN particles are hold firmly.

Good surface roughness

Allows high speed machining

Features of CBN grades for machining hardened steel and other hard materials

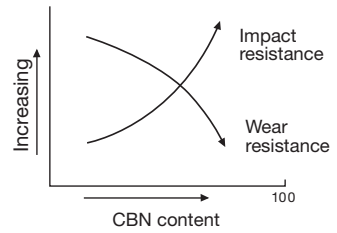

Fewer CBN content \Rightarrow Increasing wear resistance
 Much CBN content \Rightarrow Increasing impact resistance

Basic selection of T-CBN grades in machining of hardened steel and hard material

Coated T-CBN grades

- BXM10** For high speeds cutting
- BXM20** For general purpose, more than $V_c = 591$ sfm
- BXA20** For general purpose, less than $V_c = 591$ sfm

Uncoated T-CBN grades

- BX310** For high speeds / Priority on wear resistance in continuous cutting
- BX330** For medium speeds / Priority on surface quality
- BX360** For low to medium speeds / General purpose grade, excels in impact resistance
- BX380** For low to medium speeds / Priority on impact resistance in heavily interrupted cutting

PCD / CBN

Application area of coated T-CBN grades

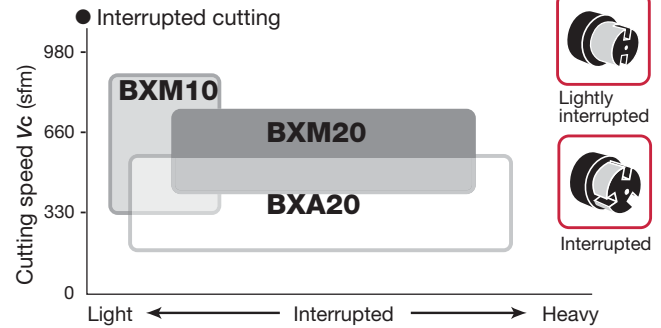
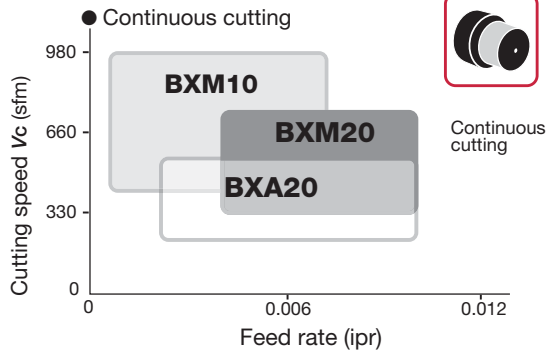

Effects of Coated T-CBN grades

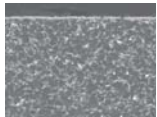

Coated on hard CBN
Hardness:
CBN > Coating layer

Protect CBN from oxidation wear

Since the coating layer intercepts air, oxidation wear of CBN can be prevented.

Peeling of coating layer can be protected

Hard and deformation resistant CBN is excellent substrate material.

Improved resistance to flank wear

Effects of coolant in machining of hardened steel

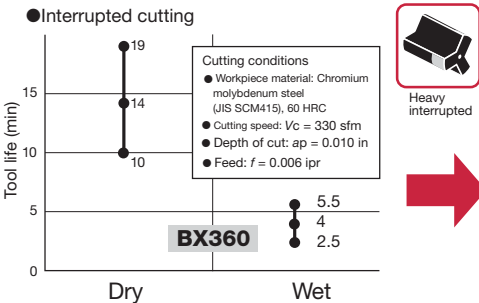
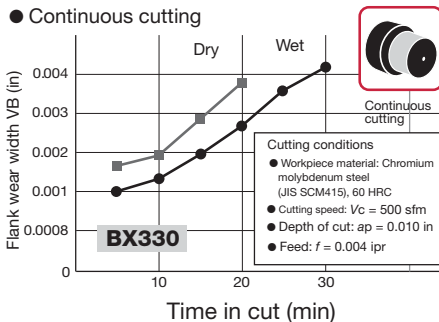

- In continuous cutting, wet cutting is superior to dry cutting in tool life for wear.
- In interrupted cutting, dry cutting is superior to wet cutting in tool life for fracture.

T-CBN series for machining sintered metals



Insert

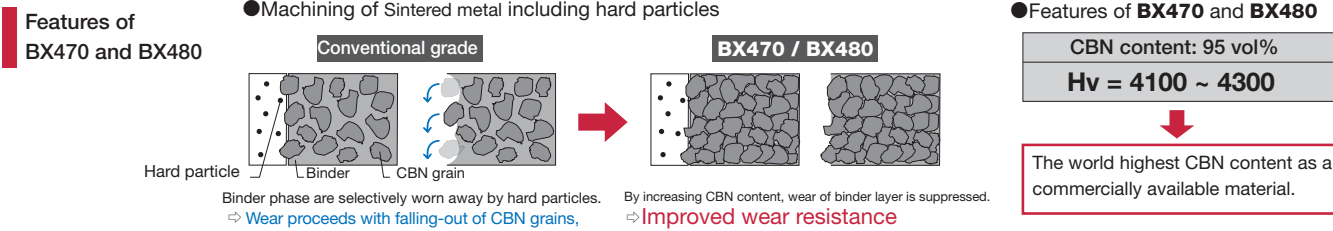
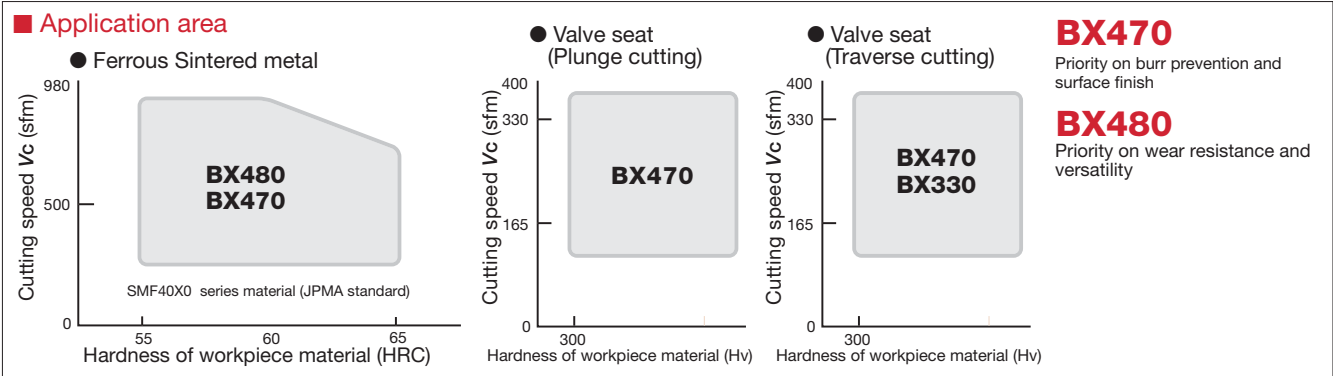

PCD / CBN

T-CBN series for machining grey and ductile cast irons

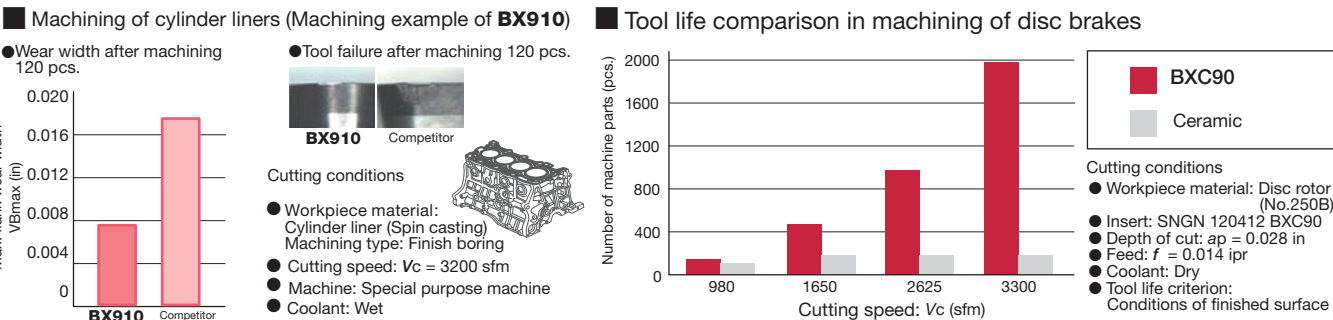
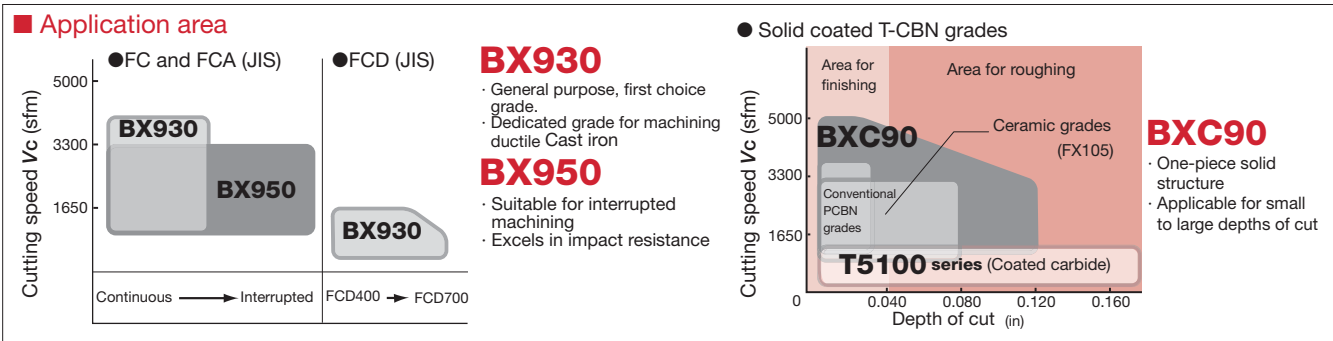

BX910 For machining cylinder liners



TurnLine - T-CBN Series

Honing specifications

- T-CBN inserts with special honing specifications are made to order. Refer to the following description.

Designation system for honing

Example:
 Honing width: 0.006 in
 Honing angle: -30°
 With R-honing



Shape Honing width (W) Honing angle (α)

T ... Chamfered honing
 S ... Chamfered + R-honing
 E ... R-honing alone
 F ... Sharp edge

Symbol

W	Amount of honing (in)	α	Honing angle
005	0.002	10°	-10°
010	0.004	15°	-15°
013	0.005	20°	-20°
015	0.006	25°	-25°
020	0.008	30°	-30°
		35°	-35°
		40°	-40°

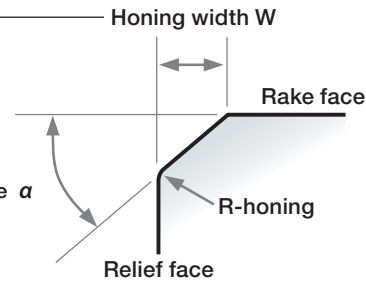

- Honing specification can be selected in combination of items described here.
- Inserts with "R" honing alone are available.

Honing specifications for machining hardened steels and other hard materials
 Standard honing: -25° + R-honing
 "-L" honing : -15° + R-honing
 "-H" honing : -35° + R-honing

Relationship between honing angle and tool life in continuous turning

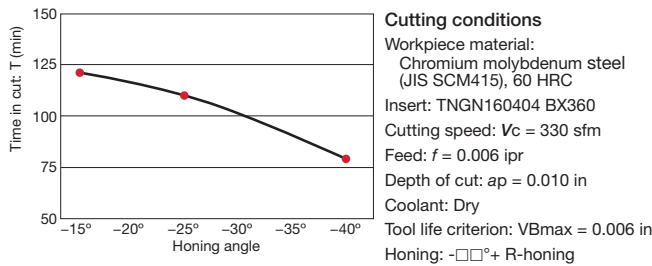

Relationship between honing angle and tool life in interrupted turning

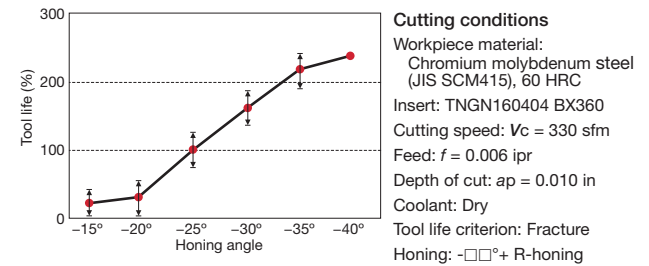

General rule

- For **continuous cutting**, small honing angle is favorable to **minimize wear** in general.
- For **interrupted cutting**, large honing angle is favorable to **minimize fracture** in general.

Standard honing specifications

Grades	BXM10	BXM20	BXA20	BXC50	BX310	BX330	BX360	BX380	BX470	BX480	BX910	BX930	BX950
Negative insert	S01325	S01325	S01325	S01325	S01325	S01325	S01325	S01325	T01315	S01325	S01315	S01315	S01325
Positive insert	S01325	S01325	S01325	-	S00515	S00515	S00515	-	T01315	-	S01315	S00515	S00515

Wiper insert

- A finishing edge (wiper edge) is formed at the point of intersection between corner radius and straight cutting edge.

Effect of wiper edge

- Doubles the productivity → Reduced machining time**
 The wiper edge can double the feed rate and moreover does not deteriorate the surface roughness. (Note: Feed rate: $f < 0.012$ ipr)
- Superior surface roughness → By integrating roughing and finishing into one process, productivity can be increased.**
 Compared with conventional inserts only with corner radius, surface roughness can be improved with the wiper edge.

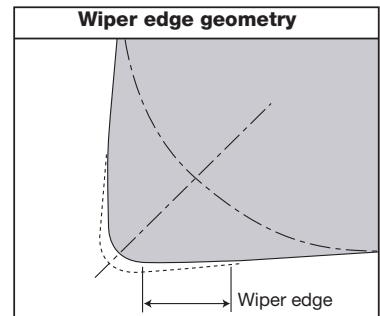

Profiles of surface roughness

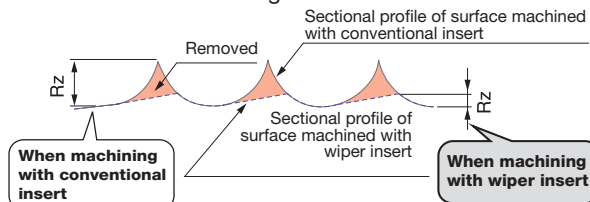

Recommended toolholders for wiper-edged inserts

	2QP-CNGA43*WL	3QP-WNGA432WL	2QP-DNGA43*WJ	3QP-TNGA33*WG
End cutting angle	95°		93°	91°
External toolholder	ACLNR/L**4-A	AWLNR/L**4-A	ADJNR/L**4-A	ATGNR/L**3-A
	DCLNR/L**4	DWLNR/L**4	DDJNR/L**4	ATFNR/L**3-A
Internal toolholder	A**-ACLNR/L4-D...	A**-AWLNR/L4-D...	A**-ADUNR/L4-D...	A**-ATFNR/L3-D...

TurnLine - CBN Insert

Negative insert · Multi-corner type

● : Continuous cutting
 ● : Light interrupted cutting
 * : Heavy interrupted cutting



Insert

Specification	Shape	Designation		Corner radius	No. of corner	CBN Length	Material																
		Inch	Metric				P	M	K	N	S	H	Sintered metal										
							Steel	Stainless	Cast iron	Non-ferrous	Superalloys	Hard materials	BXM10	BXM20	BXA20	BXC50	BX310	BX330	BX360	BX380	BX470	BX480	BX930
Sharp edge		2QP-CNGA 431-F	2QP-CNGA120404F	0.016"	2	0.091"																	
		2QP-CNGA 432-F	2QP-CNGA120408F	0.031"	2	0.087"																	
General purpose		2QP-CNGA 431	2QP-CNGA120404	0.016"	2	0.091"	●	●	●			●	●	●	●	●	●	●	●	●			
		2QP-CNGA 432	2QP-CNGA120408	0.031"	2	0.087"	●	●	●			●	●	●	●	●	●	●	●	●			
		2QP-CNGA 433	2QP-CNGA120412	0.047"	2	0.094"		●	●			●	●	●	●	●	●	●	●	●	●		
Light honing		2QP-CNGA 431-L	2QP-CNGA120404-L	0.016"	2	0.091"	●	●					●										
		2QP-CNGA 432-L	2QP-CNGA120408-L	0.031"	2	0.087"	●	●					●										
		2QP-CNGA 433-L	2QP-CNGA120412-L	0.047"	2	0.094"	●	●					●										
Heavy honing		2QP-CNGA 431-H	2QP-CNGA120404-H	0.016"	2	0.091"		●						●	●								
		2QP-CNGA 432-H	2QP-CNGA120408-H	0.031"	2	0.087"		●	●					●	●								
		2QP-CNGA 433-H	2QP-CNGA120412-H	0.047"	2	0.094"		●						●	●								
Wiper edge		2QP-CNGA 431-WL	2QP-CNGA120404WL	0.016"	2	0.091"	●	●															
		2QP-CNGA 432-WL	2QP-CNGA120408WL	0.031"	2	0.087"	●	●	●														
		2QP-CNGA 433-WL	2QP-CNGA120412WL	0.047"	2	0.094"	●	●															
General purpose		2QP-CNGA 431-W	2QP-CNGA120404-W	0.016"	2	0.091"								●									
		2QP-CNGA 432-W	2QP-CNGA120408-W	0.031"	2	0.087"								●									
		2QP-CNMA 431-W	2QP-CNMA120404W	0.016"	2	0.091"								●									
General purpose		T2QP-CNGA 431	T2QP-CNGA120404	0.016"	2	0.091"									●								
		T2QP-CNGA 432	T2QP-CNGA120408	0.031"	2	0.087"									●								
		4QP-CNGA 431	4QP-CNGA120404	0.016"	4	0.091"					●												
General purpose		4QP-CNGA 432	4QP-CNGA120408	0.031"	4	0.087"					●												
		4QP-CNGA 433	4QP-CNGA120412	0.047"	4	0.094"					●												
		4QP-CNMA 431-W	4QP-CNMA120404W	0.016"	4	0.091"					●												
Wiper edge		4QP-CNMA 432-W	4QP-CNMA120408W	0.031"	4	0.087"					●												
		4QP-CNMA 433-W	4QP-CNMA120412W	0.047"	4	0.094"					●												
		*2QP-GNGA 431	*2QP-GNGA120404	0.016"	2	0.091"		●	●						●								
General purpose		*2QP-GNGA 432	*2QP-GNGA120408	0.031"	2	0.087"		●	●					●			●			●			
		*2QP-GNGA 433	*2QP-GNGA120412	0.047"	2	0.094"		●	●						●			●			●		
		2QP-DNGA 431	2QP-DNGA150404	0.016"	2	0.098"	●	●					●	●	●	●	●	●	●	●	●	●	
General purpose		2QP-DNGA 432	2QP-DNGA150408	0.031"	2	0.083"	●	●	●				●	●	●	●	●	●	●	●	●	●	
		2QP-DNGA 433	2QP-DNGA150412	0.047"	2	0.079"	●	●					●	●	●	●	●	●	●	●	●	●	
		2QP-DNGA 431-L	2QP-DNGA150404-L	0.016"	2	0.098"	●	●						●									
Light honing		2QP-DNGA 432-L	2QP-DNGA150408-L	0.031"	2	0.083"	●	●						●									
		2QP-DNGA 433-L	2QP-DNGA150412-L	0.047"	2	0.079"	●	●						●									
		2QP-DNGA 431-H	2QP-DNGA150404-H	0.016"	2	0.098"		●							●	●							
Heavy honing		2QP-DNGA 432-H	2QP-DNGA150408-H	0.031"	2	0.083"		●	●					●	●								
		2QP-DNGA 433-H	2QP-DNGA150412-H	0.047"	2	0.079"		●						●	●								
		2QP-DNGA 431-WJ	2QP-DNGA150404WJ	0.016"	2	0.098"	●	●	●														
Wiper edge		2QP-DNGA 432-WJ	2QP-DNGA150408WJ	0.031"	2	0.083"	●	●	●														
		2QP-DNGA 441	2QP-DNGA150604	0.016"	2	0.098"	●	●															
		2QP-DNGA 442	2QP-DNGA150608	0.031"	2	0.083"	●	●	●														
General purpose		2QP-DNGA 443	2QP-DNGA150612	0.047"	2	0.079"	●	●					●										

Note:
 Letter "T" in the first position of designation shows that the standard packing quantity is 10 pieces.
 Recommended toolholders for wiper inserts, W, WL, or WJ are shown on page B164.

-W = Straight / Flat Wiper
 -WL = Arched Wiper
 * Tungaloy's original shape

Reference pages

External toolholders → B208 - Internal toolholders → B321 -
 J series toolholders → B376 - TungCap → B223 -, F006 -

PCD / CBN



Insert

TurnLine - CBN Insert

Negative insert · Multi-corner type

● : Continuous cutting
◐ : Light interrupted cutting
✱ : Heavy interrupted cutting

P	Steel
M	Stainless
K	Cast iron
N	Non-ferrous
S	Superalloys
H	Hard materials
	Sintered metal

Specification	Shape	Designation		Corner radius	No. of corner	CBN Length																	
		Inch	Metric				BXM10	BXM20	BXA20	BXC50	BX310	BX330	BX360	BX380	BX470	BX480	BX910	BX930	BX950				
General purpose		4QP-DNGA 431	4QP-DNGA150404	0.016"	4	0.098"																	
		4QP-DNGA 432	4QP-DNGA150408	0.031"	4	0.083"																	
		4QP-DNGA 433	4QP-DNGA150412	0.047"	4	0.079"																	
General purpose		2QP-SNGA 431	2QP-SNGA120404	0.016"	2	0.094"		●															
		2QP-SNGA 432	2QP-SNGA120408	0.031"	2	0.094"		●															
		2QP-SNGA 433	2QP-SNGA120412	0.047"	2	0.094"		●															
Light honing		2QP-SNGA 431-L	2QP-SNGA120404-L	0.016"	2	0.094"																	
		2QP-SNGA 432-L	2QP-SNGA120408-L	0.031"	2	0.094"		●															
		2QP-SNGA 433-L	2QP-SNGA120412-L	0.047"	2	0.094"		●															
Heavy honing		2QP-SNGA 431-H	2QP-SNGA120404-H	0.016"	2	0.094"																	
		2QP-SNGA 432-H	2QP-SNGA120408-H	0.031"	2	0.094"		●															
		2QP-SNGA 433-H	2QP-SNGA120412-H	0.047"	2	0.094"		●															
General purpose		4QP-SNGA 431	4QP-SNGA120404	0.016"	4	0.094"																	
		4QP-SNGA 432	4QP-SNGA120408	0.031"	4	0.094"																	
		4QP-SNGA 433	4QP-SNGA120412	0.047"	4	0.094"																	
General purpose		2QP-SNGN 322	2QP-SNGN090308	0.031"	2	0.094"																	
		2QP-SNGN 323	2QP-SNGN090312	0.047"	2	0.094"																	
Sharp edge		3QP-TNGA 331-F	3QP-TNGA160404F	0.016"	3	0.087"																	
		3QP-TNGA 332-F	3QP-TNGA160408F	0.031"	3	0.075"																	
General purpose		3QP-TNGA 331	3QP-TNGA160404	0.016"	3	0.087"	●	●	●														
		3QP-TNGA 332	3QP-TNGA160408	0.031"	3	0.075"	●	●	●														
		3QP-TNGA 333	3QP-TNGA160412	0.047"	3	0.094"	●	●	●														
Light honing		3QP-TNGA 331-L	3QP-TNGA160404-L	0.016"	3	0.087"	●	●															
		3QP-TNGA 332-L	3QP-TNGA160408-L	0.031"	3	0.075"	●	●															
		3QP-TNGA 333-L	3QP-TNGA160412-L	0.047"	3	0.094"	●	●															
Heavy honing		3QP-TNGA 331-H	3QP-TNGA160404-H	0.016"	3	0.087"		●															
		3QP-TNGA 332-H	3QP-TNGA160408-H	0.031"	3	0.075"		●	●														
		3QP-TNGA 333-H	3QP-TNGA160412-H	0.047"	3	0.094"		●	●														
Wiper edge		3QP-TNGA 331-WG	3QP-TNGA160404WG	0.016"	3	0.087"		●	●														
		3QP-TNGA 332-WG	3QP-TNGA160408WG	0.031"	3	0.075"	●	●															
General purpose		T3QP-TNGA 331	T3QP-TNGA160404	0.016"	3	0.087"																	
		T3QP-TNGA 332	T3QP-TNGA160408	0.031"	3	0.075"																	
General purpose		6QP-TNGA 331	6QP-TNGA160404	0.016"	6	0.087"																	
		6QP-TNGA 332	6QP-TNGA160408	0.031"	6	0.075"																	
		6QP-TNGA 333	6QP-TNGA160412	0.047"	6	0.094"																	

Note:
Letter "T" in the first position of designation shows that the standard packing quantity is 10 pieces. ● : Line up
Recommended toolholders for wiper inserts, WG are shown on page B164.

Reference pages
External toolholders → B210 - Internal toolholders → B322 -
J series toolholders → B377 - TungCap → B223 -, F006 -

TurnLine - CBN Insert

Negative insert · Multi-corner type

● : Continuous cutting
 ● : Light interrupted cutting
 * : Heavy interrupted cutting



Insert

Specification	Shape	Designation		Corner radius	No. of corner	CBN Length												
		Inch	Metric				BXM10	BXM20	BXA20	BXC50	BX310	BX330	BX360	BX380	BX470	BX480	BX930	BX950
General purpose		2QP-VNGA 331	2QP-VNGA160404	0.016"	2	0.122"	●	●	●		●	●	●	●	●	●	●	●
		2QP-VNGA 332	2QP-VNGA160408	0.031"	2	0.087"	●	●	●		●	●	●	●	●	●	●	●
		2QP-VNGA 333	2QP-VNGA160412	0.047"	2	0.118"		●										
Light honing		2QP-VNGA 331-L	2QP-VNGA160404-L	0.016"	2	0.122"	●	●			●							
		2QP-VNGA 332-L	2QP-VNGA160408-L	0.031"	2	0.087"	●	●			●							
Heavy honing		2QP-VNGA 331-H	2QP-VNGA160404-H	0.016"	2	0.122"		●	●			●	●					
		2QP-VNGA 332-H	2QP-VNGA160408-H	0.031"	2	0.087"		●	●			●	●					
General purpose		4QP-VNGA 331	4QP-VNGA160404	0.016"	4	0.122"				●								
		4QP-VNGA 332	4QP-VNGA160408	0.031"	4	0.087"				●								
General purpose		3QP-WNGA 432	3QP-WNGA080408	0.031"	3	0.087"	●	●	●		●	●	●	●		●	●	●
		3QP-WNGA 433	3QP-WNGA080412	0.047"	3	0.106"								●				
Wiper edge		3QP-WNGA 432-WL	3QP-WNGA080408WL	0.031"	3	0.087"	●	●										
General purpose		6QP-WNGA 431	6QP-WNGA080404	0.016"	6	0.122"				●								
		6QP-WNGA 432	6QP-WNGA080408	0.031"	6	0.087"				●								

PCD / CBN

Note:
 Recommended toolholders for wiper inserts, WL are shown on page B164.
 -WL = Arched Wiper

● : Line up

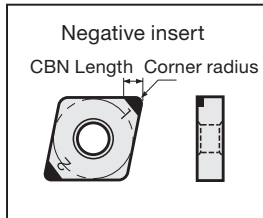

Reference pages

External toolholders → B210 - Internal toolholders → B322 -
 TungCap → B223 -, F006 -



Insert

TurnLine - CBN Insert

● : Continuous cutting
● : Light interrupted cutting
* : Heavy interrupted cutting

Negative insert · Multi-corner type Hard Breaker
(T-CBN insert with chipbreaker)

Specification	Shape	Designation		Corner radius	No. of corner	CBN Length	Material																
		Inch	Metric				P	M	K	N	S	H											
							Steel	Stainless	Cast iron	Non-ferrous	Superalloys	Hard materials											
		2QP-CNGM 432-HF	2QP-CNGM120408-HF	0.031"	2	0.087"	●																
		2QP-CNGM 433-HF	2QP-CNGM120412-HF	0.047"	2	0.094"	●																
		2QP-DNGM 432-HF	2QP-DNGM150408-HF	0.031"	2	0.083"	●																
		2QP-DNGM 433-HF	2QP-DNGM150412-HF	0.047"	2	0.079"	●																
		3QP-TNGM 332-HF	3QP-TNGM160408-HF	0.031"	3	0.075"	●																
		3QP-TNGM 333-HF	3QP-TNGM160412-HF	0.047"	3	0.094"	●																
		2QP-VNGM 332-HF	2QP-VNGM160408-HF	0.031"	2	0.087"	●																
With chipbreaker		2QP-CNGM 432-HM	2QP-CNGM120408-HM	0.031"	2	0.087"	●	●															
		2QP-CNGM 433-HM	2QP-CNGM120412-HM	0.047"	2	0.094"	●	●															
		2QP-DNGM 432-HM	2QP-DNGM150408-HM	0.031"	2	0.083"	●																
		2QP-DNGM 433-HM	2QP-DNGM150412-HM	0.047"	2	0.079"	●																
		3QP-TNGM 332-HM	3QP-TNGM160408-HM	0.031"	3	0.075"	●																
		3QP-TNGM 333-HM	3QP-TNGM160412-HM	0.047"	3	0.087"	●																
		2QP-VNGM 332-HM	2QP-VNGM160408-HM	0.031"	2	0.094"	●																

● : Line up

“Hard Breakers” for removing the carburized layer

Two types of chipbreaker provide excellent chip control in a wide application range !

HF type For finishing

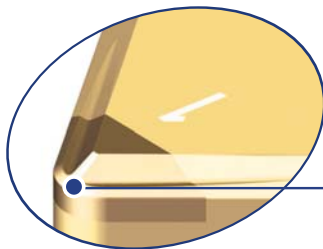

Single sided CBN insert provides higher stability in heavy machining.

Excellent chip control in small DoC due to the high functional nose. Delivers exceptional surface finishes.

■ Example of chips

● HF type

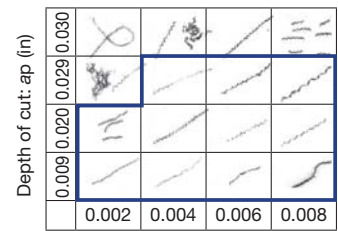

Feed: f (ipr)

HM type For medium cutting

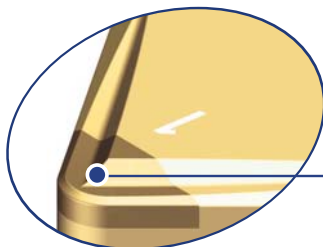

Single sided CBN insert provides higher stability in heavy machining.

Providing ideal chip control in large DoC by the well designed chipbreaker. Suitable for medium cutting or roughing.

■ Example of chips

● HM type

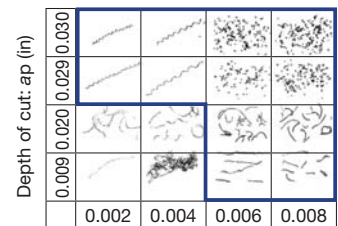

Feed: f (ipr)

PCD / CBN

TurnLine - CBN Insert

Negative insert · One-corner type

● : Continuous cutting
 ● : Light interrupted cutting
 ※ : Heavy interrupted cutting



Insert

Specification	Shape	Designation		Corner radius	No. of corner	CBN Length	Material															
		Inch	Metric				P	M	K	N	S	H	●	●	●	●						
												●	●	●	●	●	●	●	●	●	●	
General purpose		CNGA 430.5 QBN	CNGA120402-QBN	0.008"	1	0.161"	●															
		CNGA 431 QBN	CNGA120404-QBN	0.016"	1	0.157"	●															
		CNGA 432 QBN	CNGA120408-QBN	0.031"	1	0.154"	●															
		CNGA 433 QBN	CNGA120412-QBN	0.047"	1	0.154"	●															
		DNGA 430.5 QBN	DNGA150402-QBN	0.008"	1	0.169"	●															
		DNGA 431 QBN	DNGA150404-QBN	0.016"	1	0.161"	●															
		DNGA 432 QBN	DNGA150408-QBN	0.031"	1	0.150"	●															
		DNGA 433 QBN	DNGA150412-QBN	0.047"	1	0.134"	●															
		SNGA 430.5 QBN	SNGA120402-QBN	0.008"	1	0.161"	●															
		SNGA 431 QBN	SNGA120404-QBN	0.016"	1	0.161"	●															
		SNGA 432 QBN	SNGA120408-QBN	0.031"	1	0.161"	●															
		SNGA 433 QBN	SNGA120412-QBN	0.047"	1	0.161"	●															
		TNGA 330.5 QBN	TNGA160402-QBN	0.008"	1	0.173"	●															
		TNGA 331 QBN	TNGA160404-QBN	0.016"	1	0.165"	●															
		TNGA 332 QBN	TNGA160408-QBN	0.031"	1	0.157"	●															
		TNGA 333 QBN	TNGA160412-QBN	0.047"	1	0.146"	●															

PCD / CBN

● : Line up

Reference pages

External toolholders → B208 - Internal toolholders → B321 -
 J series toolholders → B376 - TungCap → B223 -, F006 -



Insert

TurnLine - CBN Insert

Positive insert · Multi-corner type (G class)

● : Continuous cutting
 ● : Light interrupted cutting
 ⊛ : Heavy interrupted cutting

Specification	Shape	Designation		Corner radius	No. of corner	CBN Length													
		Inch	Metric				BXM10	BXM20	BXA20	BX470	BX910								
General purpose		2QP-CCGW 21.50.5	2QP-CCGW060202	0.008"	2	0.091"	●	●											
		2QP-CCGW 21.51	2QP-CCGW060204	0.016"	2	0.091"	●	●	●	●									
		2QP-CCGW 32.51	2QP-CCGW09T304	0.016"	2	0.091"	●	●	●	●									
		2QP-CCGW 32.52	2QP-CCGW09T308	0.031"	2	0.087"	●	●	●	●									
General purpose		2QP-DCGW21.50	2QP-DCGW070202	0.008"	2	0.106"	●	●	●										
		2QP-DCGW21.51	2QP-DCGW070204	0.016"	2	0.098"	●	●	●	●									
		2QP-DCGW21.52	2QP-DCGW070208	0.031"	2	0.098"				●									
Sharp edge		2QP-DCGW32.50.5F	2QP-DCGW11T302F	0.008"	2	0.106"				●									
		2QP-DCGW32.51F	2QP-DCGW11T304F	0.016"	2	0.098"				●									
General purpose		2QP-DCGW32.50.5	2QP-DCGW11T302	0.008"	2	0.106"	●	●											
		2QP-DCGW32.51	2QP-DCGW11T304	0.016"	2	0.098"	●	●		●									
		2QP-DCGW32.52	2QP-DCGW11T308	0.031"	2	0.083"	●	●	●	●									
General purpose		2QP-SPGW 32.52	2QP-SPGW09T308	0.031"	2	0.094"							●						
		2QP-SPGW 32.53	2QP-SPGW09T312	0.047"	2	0.094"								●					
		2QP-SPGW 432	2QP-SPGW120408	0.031"	2	0.094"								●					
		2QP-SPGW 433	2QP-SPGW120412	0.047"	2	0.094"								●					
General purpose		2QP-SPGW 434	2QP-SPGW120416	0.063"	2	0.094"							●						
		2QP-SPGN 322	2QP-SPGN090308	0.031"	2	0.094"								●					
General purpose		2QP-SPGN 323	2QP-SPGN090312	0.047"	2	0.094"							●						
		General purpose		3QP-TPGW 631	3QP-TPGW080204	0.016"	3	0.087"	●	●									
3QP-TPGW 730.5	3QP-TPGW090202			0.008"	3	0.091"		●											
3QP-TPGW 731	3QP-TPGW090204			0.016"	3	0.087"	●	●											
3QP-TPGW 21.50	3QP-TPGW110202			0.008"	3	0.091"		●											
3QP-TPGW 21.51	3QP-TPGW110204			0.016"	3	0.087"	●	●		●									
3QP-TPGW 21.52	3QP-TPGW110208			0.031"	3	0.087"				●									
Sharp edge				3QP-TPGW 221F	3QP-TPGW110304F	0.016"	3	0.087"				●							
				3QP-TPGW 222F	3QP-TPGW110308F	0.031"	3	0.078"				●							
				3QP-TPGW 220	3QP-TPGW110302	0.008"	3	0.091"		●									
General purpose		3QP-TPGW 221	3QP-TPGW110304	0.016"	3	0.087"	●	●	●	●									
		3QP-TPGW 222	3QP-TPGW110308	0.031"	3	0.087"	●	●	●	●	●								
		3QP-TPGW 2.520.5	3QP-TPGW130302	0.008"	3	0.091"		●											
		3QP-TPGW 2.521	3QP-TPGW130304	0.016"	3	0.087"	●	●											
General purpose		3QP-TPGW 32.51	3QP-TPGW16T304	0.016"	3	0.087"	●	●											
		3QP-TPGW 32.52	3QP-TPGW16T308	0.031"	3	0.075"	●	●											
		3QP-TPGW 331	3QP-TPGW160404	0.016"	3	0.087"	●	●											
General purpose		3QP-TPGW 322	3QP-TPGW160408	0.031"	3	0.075"		●											
		General purpose		3QP-TPGN 222	3QP-TPGN110308	0.031"	3	0.087"							●				
3QP-TPGN 223	3QP-TPGN110312			0.047"	3	0.094"								●					

● : Line up

Reference pages

External toolholders → **B228** - Internal toolholders → **B299** -
 J series toolholders → **B362** -

TurnLine - CBN Insert

Positive insert · Multi-corner type (G class)

- : Continuous cutting
- ◐ : Light interrupted cutting
- ⊛ : Heavy interrupted cutting



Insert

Specification	Shape	Designation		Corner radius	No. of corner	CBN Length	Material															
		Inch	Metric				P	M	K	N	S	H										
General purpose		2QP-VBGW 221	2QP-VBGW110304	0.016"	2	0.122"	●	●	●													
		2QP-VBGW 222	2QP-VBGW110308	0.031"	2	0.087"	●	●	●													
		2QP-VBGW 331	2QP-VBGW160404	0.016"	2	0.122"	●	●	●													
		2QP-VBGW 332	2QP-VBGW160408	0.031"	2	0.087"	●	●	●													
General purpose		2QP-VCGW 331	2QP-VCGW160404	0.016"	2	0.122"	●	●														

● : Line up

PCD / CBN

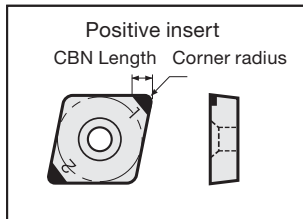

Reference pages

External toolholders → B229 -	Internal toolholders → B306 -
J series toolholders → B371 -	TungCap → F011 -



Insert

TurnLine - CBN Insert

Positive insert · Multi-corner type

● : Continuous cutting
 ● : Light interrupted cutting
 * : Heavy interrupted cutting

	P	M	K	N	S	H
Steel	●	●	●	●	●	●
Stainless		●				
Cast iron			●			
Non-ferrous				●		
Superalloys					●	
Hard materials			●	●	●	●

Specification	Shape	Designation		Corner radius	No. of corner	CBN Length													
		Inch	Metric				BX310	BX330	BX360	BX930	BX950								
General purpose		2QP-CCMW 21.50.5	2QP-CCMW060202	0.008"	2	0.091"	●	●	●										
		2QP-CCMW 21.51	2QP-CCMW060204	0.016"	2	0.091"	●	●	●	●	●								
		2QP-CCMW 32.51	2QP-CCMW09T304	0.016"	2	0.091"	●	●	●	●	●								
		2QP-CCMW 32.52	2QP-CCMW09T308	0.031"	2	0.087"	●	●	●										
General purpose		2QP-DCMW 21.50.5	2QP-DCMW070202	0.008"	2	0.106"	●	●	●										
		2QP-DCMW 21.51	2QP-DCMW070204	0.016"	2	0.098"	●	●	●	●	●								
		2QP-DCMW 32.50.5	2QP-DCMW11T302	0.008"	2	0.106"	●	●	●										
		2QP-DCMW 32.51	2QP-DCMW11T304	0.016"	2	0.098"	●	●	●	●	●								
General purpose		2QP-SPMN 321	2QP-SPMN090304	0.016"	2	0.094"		●	●	●									
		2QP-SPMN 322	2QP-SPMN090308	0.031"	2	0.094"		●	●	●									
General purpose		3QP-TPMW 631	3QP-TPMW080204	0.016"	3	0.087"	●	●	●	●									
		3QP-TPMW 730.5	3QP-TPMW090202	0.008"	3	0.091"		●	●	●									
		3QP-TPMW 731	3QP-TPMW090204	0.016"	3	0.087"	●	●	●	●									
		3QP-TPMW 21.50.5	3QP-TPMW110202	0.008"	3	0.091"	●	●	●	●									
		3QP-TPMW 21.51	3QP-TPMW110204	0.016"	3	0.087"	●	●	●	●									
		3QP-TPMW 220.5	3QP-TPMW110302	0.008"	3	0.095"	●	●	●	●	●								
		3QP-TPMW 221	3QP-TPMW110304	0.016"	3	0.087"	●	●	●	●	●								
		3QP-TPMW 222	3QP-TPMW110308	0.031"	3	0.075"	●	●	●	●	●								
		3QP-TPMW 2.520.5	3QP-TPMW130302	0.008"	3	0.095"	●	●	●	●	●								
		3QP-TPMW 2.521	3QP-TPMW130304	0.016"	3	0.087"	●	●	●	●	●								
		3QP-TPMW 32.51	3QP-TPMW16T304	0.016"	3	0.087"	●	●	●	●	●								
		3QP-TPMW 32.52	3QP-TPMW16T308	0.031"	3	0.075"	●												
		3QP-TPMW 331	3QP-TPMW160404	0.016"	3	0.087"	●	●	●	●									
		3QP-TPMW 332	3QP-TPMW160408	0.031"	3	0.075"	●	●	●	●									
General purpose		3QP-TPU 220.5	3QP-TPMN110302	0.008"	3	0.091"		●	●	●	●								
		3QP-TPU 221	3QP-TPMN110304	0.016"	3	0.087"		●	●	●	●								
		3QP-TPU 222	3QP-TPMN110308	0.031"	3	0.075"		●	●	●	●								
		3QP-TPU 321	3QP-TPMN160304	0.016"	3	0.087"		●	●	●	●								
General purpose		2QP-VBMW221	2QP-VBMW110304	0.016"	2	0.122"	●	●	●	●									
		2QP-VBMW222	2QP-VBMW110308	0.031"	2	0.087"	●	●	●	●									
		2QP-VBMW331	2QP-VBMW160404	0.016"	2	0.122"	●	●	●										
		2QP-VBMW332	2QP-VBMW160408	0.031"	2	0.087"	●	●	●										
General purpose		2QP-VCMW331	2QP-VCMW160404	0.016"	2	0.122"		●	●	●									

● : Line up

Reference pages

External toolholders → B228 - Internal toolholders → B299 -
 J series toolholders → B362 - TungCap → F011 -

TurnLine - CBN Insert

Positive insert · One-corner type

● : Continuous cutting
 ● : Light interrupted cutting
 * : Heavy interrupted cutting



Insert

Specification	Shape	Designation		Corner radius	No. of corner	CBN Length	Material															
		Inch	Metric				P	M	K	N	S	H	●	●	*	*						
							Steel	Stainless	Cast iron	Non-ferrous	Superalloys	Hard materials	●	●	*	*						
General purpose		Q-CCMW 21.51	Q-CCMW060204	0.016"	1	0.098"	●															
		Q-CCMW 32.51	Q-CCMW09T304	0.016"	1	0.098"	●															
General purpose		Q-DCMW 21.51	Q-DCMW070204	0.016"	1	0.083"	●															
		Q-DCMW 32.51	Q-DCMW11T304	0.016"	1	0.083"	●															
General purpose		Q-SPGN 321	Q-SPGN090304	0.016"	1	0.110"	●															
		Q-SPGN 322	Q-SPGN090308	0.031"	1	0.110"	●															
General purpose		Q-TPMW 631	Q-TPMW080204	0.016"	1	0.087"	●															
		Q-TPMW 730.5	Q-TPMW090202	0.008"	1	0.094"	●															
		Q-TPMW 731	Q-TPMW090204	0.016"	1	0.091"	●															
		Q-TPMW 21.50.5	Q-TPMW110202	0.008"	1	0.094"	●															
		Q-TPMW 21.51	Q-TPMW110204	0.016"	1	0.087"	●															
		Q-TPMW 221	Q-TPMW110304	0.016"	1	0.091"	●															
		Q-TPMW 222	Q-TPMW110308	0.031"	1	0.087"	●															
		Q-TPMW 2.520.5	Q-TPMW130302	0.008"	1	0.094"	●															
		Q-TPMW 2.521	Q-TPMW130304	0.016"	1	0.091"	●															
		Q-TPMW 32.51	Q-TPMW16T304	0.016"	1	0.091"	●															
		Q-TPMW 331	Q-TPMW160404	0.016"	1	0.091"	●															
		Q-TPMW 332	Q-TPMW160408	0.031"	1	0.075"	●															
General purpose		Q-TPGN221	Q-TPGN110304	0.016"	1	0.087"	●															
		Q-TPGN 222	Q-TPGN110308	0.031"	1	0.087"	●															
		Q-TPGN160304	Q-TPGN160304	0.016"	1	0.091"	●															
		Q-TPGN160308	Q-TPGN160308	0.031"	1	0.075"	●															

Note: Packing Qty : 2 pcs.

Positive insert · Mini

Specification	Shape	Designation		Corner radius	No. of corner	CBN Length	Material														
		Inch	Metric				P	M	K	N	S	H	●	●	*	*					
							Steel	Stainless	Cast iron	Non-ferrous	Superalloys	Hard materials	Sintered metal	●	●	*	*				
General purpose		1QP-CCGW 4.51.80.5	1QP-CCGW03X102	0.008"	1	0.055"	●	●													
		1QP-CCGW 4.51.81	1QP-CCGW03X104	0.016"	1	0.051"	●	●													
		1QP-CCGW 5.52.20.5	1QP-CCGW04T102	0.008"	1	0.075"	●	●													
		1QP-CCGW 5.52.21	1QP-CCGW04T104	0.016"	1	0.071"	●	●													
General purpose		1QP-EPGW 4.51.80.5	1QP-EPGW03X102	0.008"	1	0.055"	●	●													
		1QP-EPGW 4.51.81	1QP-EPGW03X104	0.016"	1	0.051"	●	●													
		1QP-EPGW 520.5	1QP-EPGW040102	0.008"	1	0.067"	●	●													
		1QP-EPGW 521	1QP-EPGW040104	0.016"	1	0.063"	●	●													

● : Line up

Reference pages

External toolholders → B228 - Internal toolholders → B299 -
 J series toolholders → B362 -

PCD / CBN



Insert

TurnLine - CBN Insert

Positive insert · One-corner type

● : Continuous cutting
◐ : Light interrupted cutting
✱ : Heavy interrupted cutting

PCD / CBN

Specification	Shape	Designation		Corner radius	No. of corner	CBN Length														
		Inch	Metric				BX360													
General purpose		SPG 321 QBN	SPGN090304-QBN	0.016"	1	0.161"	●													
		SPG 322 QBN	SPGN090308-QBN	0.031"	1	0.161"	●													
		SPG 323 QBN	SPGN090312-QBN	0.047"	1	0.161"	●													
		SPG 422 QBN	SPGN120308-QBN	0.031"	1	0.161"	●													
		SPG 423 QBN	SPGN120312-QBN	0.047"	1	0.161"	●													
General purpose		TPGW 730.5 QBN	TPGW090202-QBN	0.008"	1	0.130"	●													
		TPGW 731 QBN	TPGW090204-QBN	0.016"	1	0.126"	●													
		TPGW 21.50.5 QBN	TPGW110202-QBN	0.008"	1	0.154"	●													
		TPGW 21.51 QBN	TPGW110204-QBN	0.016"	1	0.146"	●													
		TPGW 2.520.5 QBN	TPGW130302-QBN	0.008"	1	0.154"	●													
		TPGW 2.521 QBN	TPGW130304-QBN	0.016"	1	0.146"	●													
		TPGW 32.50.5 QBN	TPGW16T302-QBN	0.008"	1	0.173"	●													
		TPGW 32.51 QBN	TPGW16T304-QBN	0.016"	1	0.165"	●													
		TPGW 32.52 QBN	TPGW16T308-QBN	0.031"	1	0.157"	●													
		General purpose		TPG 221 QBN	TPGN110304-QBN	0.016"	1	0.146"	●											
TPG 222 QBN	TPGN110308-QBN			0.031"	1	0.138"	●													
TPG 321 QBN	TPGN160304-QBN			0.016"	1	0.165"	●													
TPG 322 QBN	TPGN160308-QBN			0.031"	1	0.157"	●													
General purpose		CPGA 31.51 QBN	CPGA090204-QBN	0.016"	1	0.157"	●													
		CPGA 31.52 QBN	CPGA090208-QBN	0.031"	1	0.150"	●													
General purpose		TPGA 730.5 QBN	TPGA090202-QBN	0.008"	1	0.122"	●													
		TPGA 731 QBN	TPGA090204-QBN	0.016"	1	0.114"	●													
		TPGA 21.50.5 QBN	TPGA110202-QBN	0.008"	1	0.154"	●													
		TPGA 21.51 QBN	TPGA110204-QBN	0.016"	1	0.146"	●													
		TPGA 220.5 QBN	TPGA110302-QBN	0.008"	1	0.154"	●													
		TPGA 221 QBN	TPGA110304-QBN	0.016"	1	0.146"	●													
		TPGA 320.5 QBN	TPGA160302-QBN	0.008"	1	0.173"	●													
		TPGA 321 QBN	TPGA160304-QBN	0.016"	1	0.165"	●													
TPGA 322 QBN	TPGA160308-QBN	0.031"	1	0.157"	●															

Positive insert · Full-face type

Specification	Shape	Designation		Corner radius	No. of corner	CBN Length												
		Inch	Metric				BX360											
General purpose		TBGN 521 QBN	TBGN060104-15-QBN	0.016"	3	-	●											
		TBGN 522 QBN	TBGN060108-15-QBN	0.031"	3	-	●											

● : Line up

Reference pages

External toolholders → B258 - Internal toolholders → B306 -





TurnLine - CBN Insert

Coated Solid CBN (BXC90)

● : Continuous cutting
 ●c : Light interrupted cutting
 ※ : Heavy interrupted cutting



Insert

Specification	Shape	Designation		Corner radius	No. of corner	Material															
		Inch	Metric			P	M	K	N	S	H	1	2	3	4	5	6	7	8	9	10
General purpose		S-CNGN 322	S-CNGN090308	0.031"	4	●c															
		S-CNGN 323	S-CNGN090312	0.047"	4	●c															
		S-CNGN 432	S-CNGN120408	0.031"	4	●c															
		S-CNGN 433	S-CNGN120412	0.047"	4	●c															
General purpose		S-RNGN 32	S-RNGN090300	-	-	●c															
		S-RNGN 43	S-RNGN120400	-	-	●c															
General purpose		S-SNGN 322	S-SNGN090308	0.031"	8	●c															
		S-SNGN 323	S-SNGN090312	0.047"	8	●c															
		S-SNGN 422	S-SNGN120308	0.031"	8	●c															
		S-SNGN 423	S-SNGN120312	0.047"	8	●c															
		S-SNGN 432	S-SNGN120408	0.031"	8	●c															
		S-SNGN 433	S-SNGN120412	0.047"	8	●c															
General purpose		S-TNGN 222	S-TNGN110308	0.031"	6	●c															
		S-TNGN 223	S-TNGN110312	0.047"	6	●c															
		S-TNGN 322	S-TNGN160408	0.031"	6	●c															
		S-TNGN 333	S-TNGN160412	0.047"	6	●c															

PCD / CBN

● : Line up



Insert

TurnLine - CBN Insert

T-CBN (PCBN tipped) grooving Insert

● : Continuous cutting
 ● : Light interrupted cutting
 * : Heavy interrupted cutting

Specification	Shape	Designation	Corner radius	No. of corner	Grooving width $\pm 0.002"$	Material																	
						P	M	K	N	S	H	●	●	●	●	●	●						
						●●																	
Grooving		XGR6310S-QBN	0.008"	1	0.039"	●●																	
		XGR6315S-QBN	0.008"	1	0.059"	●●																	
		XGR6320S-QBN	0.008"	1	0.079"	●●																	
		XGR6325S-QBN	0.008"	1	0.098"	●●																	
		XGR6330S-QBN	0.008"	1	0.118"	●●																	
		XGR6335S-QBN	0.008"	1	0.138"	●●																	
		XGR6340S-QBN	0.008"	1	0.157"	●●																	
		XGR6345S-QBN	0.008"	1	0.177"	●●																	

PCD / CBN

TungCut CBN insert for hardened steels

Specification	Shape	Designation	Corner radius	No. of corner	Grooving width $\pm 0.001"$	Material																
						P	M	K	N	S	H	●	●	●	●	●	●					
						●●																
Grooving		SGN200-020	0.008"	1	0.079"	●●																
		SGN300-020	0.008"	1	0.118"	●●																
		SGN400-020	0.008"	1	0.157"	●●																

● : Line up

Reference pages

XGR... : Toolholders → C036

SGN... : Toolholders → C060

TurnLine - PCD grade, T-DIA series

Expanded product line allows T-DIA tools to be applied to wider workpiece materials and cutting conditions.

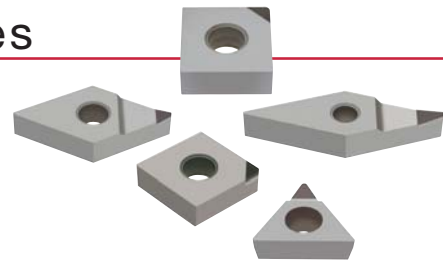

Insert

Features and applications (Physical and mechanical properties)

	DX110	DX120	DX140	DX160	DX180
Grade					
Property	Super fine grained grade. Excels in surface finish.	Fine grained grade. Excels in surface finish.	General purpose grade	High purity grade for hard materials	Highly wear resistant grade for special applications
Approx. grain size of diamond (µm)	< 1	5	13	28	45
Hardness (Hv)	8500				12000 (Harder)
Wear resistance					Higher
Grindability (Cutting edge sharpness)	Better				

Note: T-DIA grades are not suitable for ferrous materials (such as hardened steel, chilled Cast iron), and Ni- or Co-base Superalloys.

PCD / CBN

Cutting performance (Wear resistance)

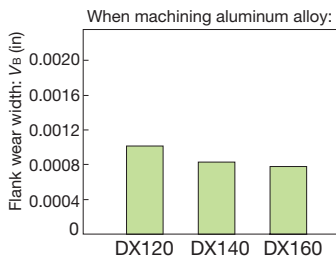

- Continuous external turning**
- Workpiece material: 10 % Si, aluminum alloy
 - Insert: SPGN120308-DIA
 - Toolholder: CSBPR2525M4
 - Cutting speed: $v_c = 1640$ sfm
 - Feed: $f = 0.004$ ipr
 - Depth of cut: $a_p = 0.020$ in
 - Coolant: Dry cutting
 - Time in cut: 30 min

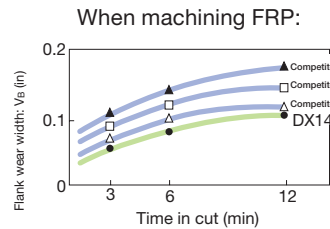

- Face milling**
- Workpiece material: Fiber reinforced plastics (FRP)
 - Insert: SPCN42ZFR-DIA
 - Milling cutter: TPG4208R-A
 - Cutting speed: $v_c = 3090$ sfm
 - Feed: $f = 0.004$ ipr
 - Depth of cut: $a_p = 0.059$ in
 - Coolant: Dry cutting

Grade selection guide

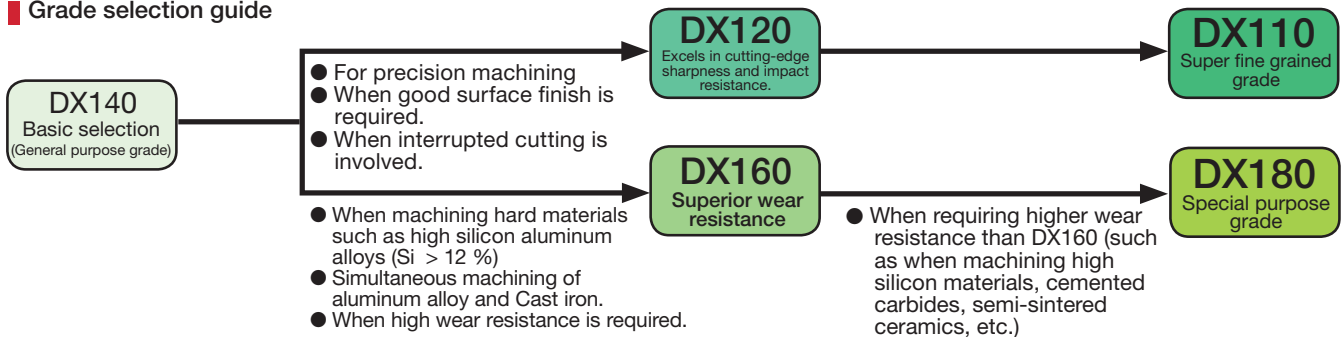

STANDARD CUTTING CONDITIONS FOR TURNING

ISO	Workpiece material	Grade applicability					Cutting speed v_c (sfm)	Depth of cut a_p (in)	Feed f (ipr)
		DX110	DX120	DX140	DX160	DX180			
N	Aluminum alloys (Si < 12 %)	○	○	◎			3300 - 8200	0.002 - 0.080	0.002 - 0.008
	Aluminum alloys (Si > 12 %)			○	◎		1300 - 2630	0.002 - 0.080	0.002 - 0.008
	Copper, brass	○	○	◎			1640 - 4920	0.002 - 0.080	0.002 - 0.008
	Phosphor bronze	○	○	◎			980 - 1640	0.002 - 0.080	0.002 - 0.008
	Carbon, graphite			◎			980 - 1640	0.002 - 0.080	0.002 - 0.008
	FRP	○	◎	○			1640 - 3300	0.002 - 0.020	0.001 - 0.004
	Plastics	○	◎	○			1640 - 3300	0.002 - 0.020	0.00039 - 0.002
	Cemented carbides (D40 ~ D60)				○	◎	30 - 65	0.002 - 0.008	0.00039 - 0.002
	Semi-sintered ceramics				○	◎	330 - 500	0.002 - 0.080	0.001 - 0.004

(Note) ◎ : First choice ○ : Second choice



Insert

TurnLine - PCD Insert

● : Continuous cutting
 ● : Light interrupted cutting
 * : Heavy interrupted cutting

Negative insert (with rake angle)

Specification	Shape	Designation		Corner radius	No. of corner	DIA Length															
		Inch	Metric																		
Low cutting force		CNMM 430.5 DIA	CNMM120402-DIA	0.008"	1	0.138"	●														
		CNMM 431 DIA	CNMM120404-DIA	0.016"	1	0.138"	●														
Low cutting force		DNMM 430.5 DIA	DNMM150402-DIA	0.008"	1	0.130"	●														
		DNMM 431 DIA	DNMM150404-DIA	0.016"	1	0.122"	●														
Low cutting force		TNMM 330.5 DIA	TNMM160402-DIA	0.008"	1	0.130"	●														
		TNMM 331 DIA	TNMM160404-DIA	0.016"	1	0.126"	●														
Low cutting force		VNMM 330.5 DIA	VNMM160402-DIA	0.008"	1	0.189"	●														
		VNMM 331 DIA	VNMM160404-DIA	0.016"	1	0.173"	●														
		VNMM 332 DIA	VNMM160408-DIA	0.031"	1	0.142"	●														

PCD / CBN

Negative insert

Specification	Shape	Designation		Corner radius	No. of corner	DIA Length														
		Inch	Metric																	
General purpose		CNGA 431 DIA	CNGA120404-DIA	0.016"	1	0.138"	●													
		CNGA 432 DIA	CNGA120408-DIA	0.031"	1	0.110"	●													
General purpose		DNGA 431 DIA	DNGA150404-DIA	0.016"	1	0.122"	●	●												
		DNGA 432 DIA	DNGA150408-DIA	0.031"	1	0.110"	●													
General purpose		SNGA 431 DIA	SNGA120404-DIA	0.016"	1	0.142"	●													
		SNGA 432 DIA	SNGA120408-DIA	0.031"	1	0.142"	●													
General purpose		SNGN 432 DIA	SNGN120408-DIA	0.031"	1	0.142"	●													
General purpose		TNGA 331 DIA	TNGA160404-DIA	0.016"	1	0.126"	●	●												
		TNGA 332 DIA	TNGA160408-DIA	0.031"	1	0.114"	●	●												

● : Line up

Reference pages

External toolholders → B208 - Internal toolholders → B321 -
 J series toolholders → B376 - TungCap → B223 -, F006 -

TurnLine - PCD Insert

Positive insert (with rake angle)

● : Continuous cutting
 ● : Light interrupted cutting
 * : Heavy interrupted cutting



Insert

Specification	Shape	Designation		Corner radius	No. of corner	Relief angle	DIA Length															
		Inch	Metric																			
Low cutting force		CCMT 21.50.5-DIA	CCMT060202-DIA	0.008"	1	7°	0.094"	●														
		CCMT 21.51-DIA	CCMT060204-DIA	0.016"	1	7°	0.094"	●														
		CCMT 32.50.5-DIA	CCMT09T302-DIA	0.008"	1	7°	0.138"	●														
		CCMT 32.51-DIA	CCMT09T304-DIA	0.016"	1	7°	0.138"	●														
Low cutting force		DCMT 21.50.5-DIA	DCMT070202-DIA	0.008"	1	7°	0.091"	●														
		DCMT 21.51-DIA	DCMT070204-DIA	0.016"	1	7°	0.083"	●														
		DCMT 32.50.5-DIA	DCMT11T302-DIA	0.008"	1	7°	0.126"	●														
		DCMT 32.51-DIA	DCMT11T304-DIA	0.016"	1	7°	0.118"	●														
Low cutting force		TCMT 630.5-DIA	TCMT080202-DIA	0.008"	1	7°	0.094"	●														
		TCMT 631-DIA	TCMT080204-DIA	0.016"	1	7°	0.091"	●														
		TCMT 21.50.5-DIA	TCMT110202-DIA	0.008"	1	7°	0.094"	●														
		TCMT 21.51-DIA	TCMT110204-DIA	0.016"	1	7°	0.087"	●														
		TCMT 220.5-DIA	TCMT110302-DIA	0.008"	1	7°	0.094"	●														
Low cutting force		VCMT 330.5-DIA	VCMT160402-DIA	0.008"	1	7°	0.189"	●														
		VCMT 331-DIA	VCMT160404-DIA	0.016"	1	7°	0.173"	●														

PCD / CBN

Positive insert

Specification	Shape	Designation		Corner radius	No. of corner	Relief angle	DIA Length														
		Inch	Metric																		
General purpose		CCGW 21.5V-DIA	CCGW060200-DIA	0.002"	1	7°	0.094"	●													
		CCGW 21.50.5-DIA	CCGW060202-DIA	0.008"	1	7°	0.094"	●													
		CCGW 21.51-DIA	CCGW060204-DIA	0.016"	1	7°	0.094"	●													
		CCGW 32.50.5-DIA	CCGW09T302-DIA	0.008"	1	7°	0.138"	●													
		CCGW 32.51-DIA	CCGW09T304-DIA	0.016"	1	7°	0.138"	●	●												
		CCGW 32.52-DIA	CCGW09T308-DIA	0.031"	1	7°	0.134"	●													
General purpose		DCGW 21.5V-DIA	DCGW070200-DIA	0.002"	1	7°	0.094"	●													
		DCGW 21.50.5-DIA	DCGW070202-DIA	0.008"	1	7°	0.091"	●													
		DCGW 21.51-DIA	DCGW070204-DIA	0.016"	1	7°	0.083"	●													
		DCGW 32.50.5-DIA	DCGW11T302-DIA	0.008"	1	7°	0.126"	●													
		DCGW 32.51-DIA	DCGW11T304-DIA	0.016"	1	7°	0.118"	●													
General purpose		SPGN 322-DIA	SPGN090308-DIA	0.031"	1	11°	0.142"	●													
		SPGN 420.5-DIA	SPGN120302-DIA	0.008"	1	11°	0.142"	●													
		SPGN 421-DIA	SPGN120304-DIA	0.016"	1	11°	0.142"	●													
		SPGN 422-DIA	SPGN120308-DIA	0.031"	1	11°	0.142"	●	●												

● : Line up

Reference pages

External toolholders → B228 - Internal toolholders → B299 -
 J series toolholders → B362 - TungCap → F011 -



Insert

TurnLine - PCD Insert

Positive insert

- : Continuous cutting
- ◐ : Light interrupted cutting
- ⊛ : Heavy interrupted cutting

P	Steel																			
M	Stainless																			
K	Cast iron																			
N	Non-ferrous	●●●●																		
S	Superalloys																			
H	Hard materials																			

Specification	Shape	Designation		Corner radius	No. of corner	Relief angle	DIA Length																
		Inch	Metric					DX120	DX140														
General purpose		CPGA 31.50.5-DIA	CPGA090202-DIA	0.008"	1	11°	0.094"	●															
		CPGA 31.51-DIA	CPGA090204-DIA	0.016"	1	11°	0.094"	●															
General purpose		EPGW 520.5-DIA	EPGW040102-DIA	0.008"	1	11°	0.075"	●															
		EPGW 521-DIA	EPGW040104-DIA	0.016"	1	11°	0.075"	●															
General purpose		TPGA730.5-DIA	TPGA090202-DIA	0.008"	1	11°	0.094"	●															
		TPGA731-DIA	TPGA090204-DIA	0.016"	1	11°	0.087"	●															
		TPGA21.50.5-DIA	TPGA110202-DIA	0.008"	1	11°	0.094"	●															
		TPGA21.51-DIA	TPGA110204-DIA	0.016"	1	11°	0.087"	●															
		TPGA220.5-DIA	TPGA110302-DIA	0.008"	1	11°	0.094"	●															
		TPGA221-DIA	TPGA110304-DIA	0.016"	1	11°	0.087"	●															
		TPGA222-DIA	TPGA110308-DIA	0.031"	1	11°	0.114"	●															
		TPGA320.5-DIA	TPGA160302-DIA	0.008"	1	11°	0.130"	●															
		TPGA321-DIA	TPGA160304-DIA	0.016"	1	11°	0.126"	●															
		TPGA322-DIA	TPGA160308-DIA	0.031"	1	11°	0.114"	●															
General purpose		TPGN 731-DIA	TPGN090204-DIA	0.016"	1	11°	0.087"	●															
		TPGN 221-DIA	TPGN110304-DIA	0.016"	1	11°	0.126"	●●															
		TPGN 222-DIA	TPGN110308-DIA	0.031"	1	11°	0.114"	●															
		TPGN 320.5-DIA	TPGN160302-DIA	0.008"	1	11°	0.130"	●															
		TPGN 321-DIA	TPGN160304-DIA	0.016"	1	11°	0.126"	●●															
General purpose		TPGN 322-DIA	TPGN160308-DIA	0.031"	1	11°	0.114"	●															
		TPGW 630.5-DIA	TPGW080202-DIA	0.008"	1	11°	0.094"	●															
		TPGW 631-DIA	TPGW080204-DIA	0.016"	1	11°	0.091"	●															
		TPGW 730.5-DIA	TPGW090202-DIA	0.008"	1	11°	0.094"	●●															
		TPGW 731-DIA	TPGW090204-DIA	0.016"	1	11°	0.087"	●															
		TPGW 21.50.5-DIA	TPGW110202-DIA	0.008"	1	11°	0.094"	●●															
		TPGW 21.51-DIA	TPGW110204-DIA	0.016"	1	11°	0.087"	●															
		TPGW 2.520.5-DIA	TPGW130302-DIA	0.008"	1	11°	0.130"	●●															
		TPGW 2.521-DIA	TPGW130304-DIA	0.016"	1	11°	0.126"	●															
		TPGW 32.50.5-DIA	TPGW16T302-DIA	0.008"	1	11°	0.130"	●															
General purpose		TPGW 32.51-DIA	TPGW16T304-DIA	0.016"	1	11°	0.126"	●															
		TPGW 32.52-DIA	TPGW16T308-DIA	0.031"	1	11°	0.114"	●															
General purpose		VCGW 330.5-DIA	VCGW160402-DIA	0.008"	1	7°	0.189"	●															
		VCGW 331-DIA	VCGW160404-DIA	0.016"	1	7°	0.173"	●															

● : Line up

Reference pages

External toolholders → B258 - Internal toolholders → B302 -

MEMO

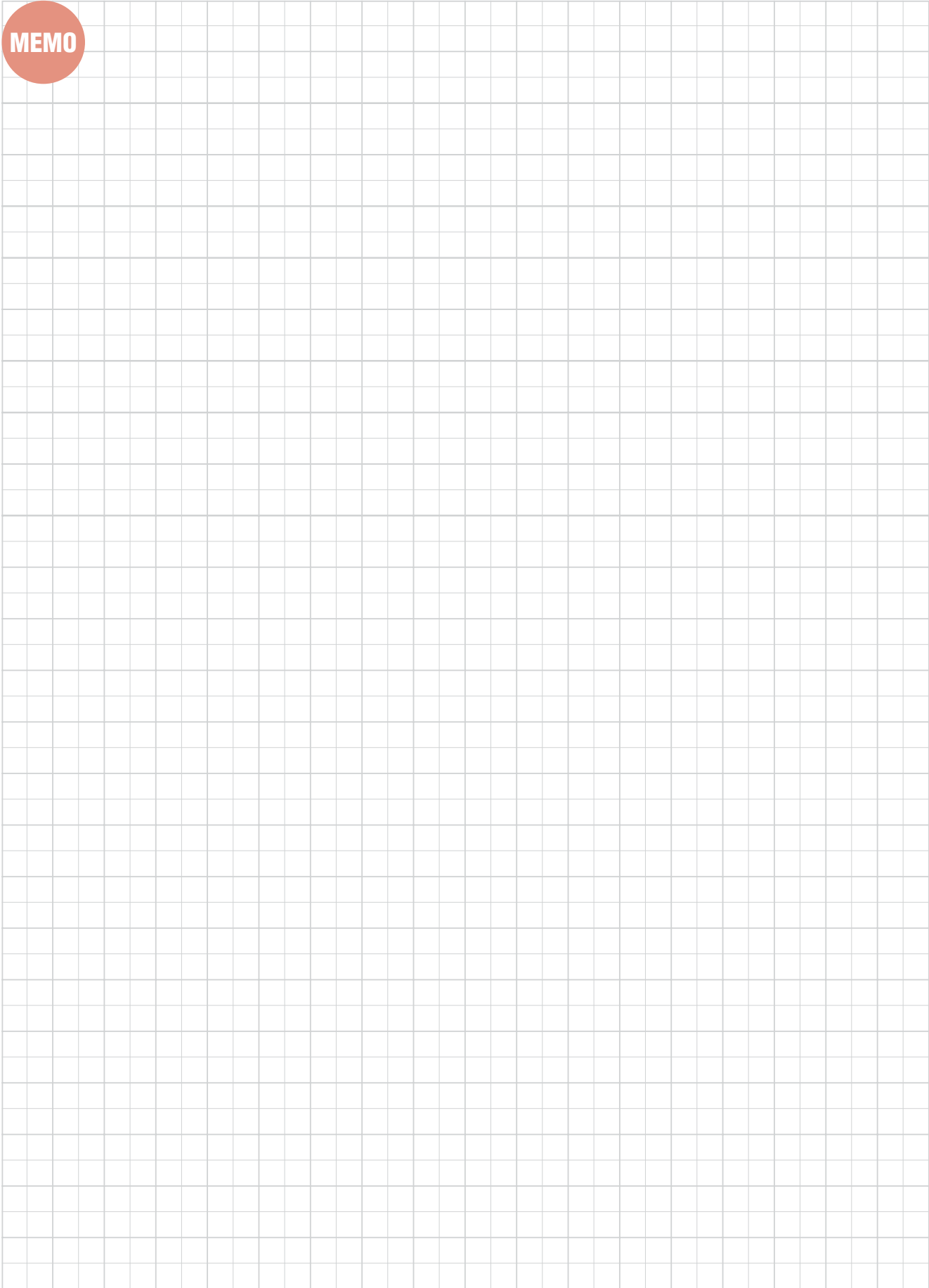

Insert

PCD / CBN

TurnLine - External Toolholder

			Inch	Metric
	MINIFORCE Economical double-sided inserts with excellent sharpness 	<u>B190</u>	<input checked="" type="checkbox"/>	<input checked="" type="checkbox"/>
	ISOECO Small-sized "Eco" insert series for maximized profits 	<u>B202</u>	<input checked="" type="checkbox"/>	<input checked="" type="checkbox"/>
	TURNINGA Highly rigid clamping system with excellent repeatability	<u>B208</u>	<input checked="" type="checkbox"/>	<input checked="" type="checkbox"/>
	TUNG TJET Toolholders for high pressure coolant supply 	<u>B218</u>	<input checked="" type="checkbox"/>	<input checked="" type="checkbox"/>
	Y-PRO SERIES Inserts with 25° corner angle for profiling	<u>B231</u>	<input checked="" type="checkbox"/>	<input checked="" type="checkbox"/>
	ISO-Turn External Toolholders for general external turning D-type, H-type, M-type, P-type, S-type, T-type	<u>B233</u>	<input checked="" type="checkbox"/>	<input checked="" type="checkbox"/>
	FIXRTURN Highly productive round insert with 6 indexes	<u>B269</u>	<input checked="" type="checkbox"/>	<input checked="" type="checkbox"/>
	DIMPLEFX Ceramic insert with dimple for highly efficient cast iron machining	<u>B271</u>	<input checked="" type="checkbox"/>	<input type="checkbox"/>
	TURNFEED Tool series for high-feed cutting	<u>B275</u>	<input checked="" type="checkbox"/>	<input type="checkbox"/>
	TURNTEC Inserts and toolholders for roughing large depths of cut with high productivity	<u>B276</u>	<input checked="" type="checkbox"/>	<input type="checkbox"/>



ISO-EcoTurn

Tungaloy B183



External Toolholder (Negative insert) - Quick Guide

	Turning / Facing		External profiling					Turning	
	L 95°		J 93°	N 63°	V 72.5°	P 62.5°	A 91°	G 91°	
Turning A Double clamping	80° CN□□	70° GN□□	55° DN□□	35° VN□□		35° VN□□	55° DN□□		60° TN□□
	ACLNR/L B202, B208	ACLNR/L B208	ADJNR/L B204, B210	AVJNR/L B207, B211		AVVNN B208, B212	ADPNN B212		ATGNR/L B213
	80° WN□□		60° TN□□	25° YNMG		25° YNMG			
	AWLNR/L B202, B210		ATJNR/L B211	AVJNR/L B211		AVVNN B212			
D One-Double	80° CN□□	70° GN□□	55° DN□□						60° TN□□
	DCLNR/L B233	DCLNR/L B233	DDJNR/L B234						DTGNR/L B234
	80° WN□□								
	DWLNR/L B233								
C Double clamping for dimple ceramic insert	80° CN□□		55° DN□□		55° DN□□	35° VN□□			
	CCLNR/L B271		CDJNR/L B271		CDNNN B272	CVVNN B272			
P Lever lock	80° CN□□	70° GN□□	55° DN□□				55° DN□□		60° TN□□
	PCLNR/L B203, B218, B223, B236, B376	PCLNR/L B203, B218, B223, B236, B376	PDJNR/L B205, B219, B223, B239, B376				PDMNL B226		PTGNR/L B206, B220, B240
	80° CN□□	70° GN□□	35° VN□□				55° DN□□		
	PCMNN B225	PCMNN B225	PVJNR/L B221, B224				PDPNN B240		
80° CN□□	70° GN□□	25° YNMG							
PCL2NR B376	PCL2NR B376	PVJNR/L B221, B224							
80° WN□□	60° TN□□								
PWLNR/L B204, B222, B224	PTL2NR/L B239, B378								
M Multi clamping	80° CN□□	70° GN□□	35° VN□□	55° DN□□		35° VN□□	55° DN□□		
	MCLNR/L B246	MCLNR/L B246	MVJNR/L B247	MDJNR/L B247		MVVNN B248	MDPNN B249		
	80° CN□□	80° WN□□	25° YNMG	55° DN□□		25° YNMG	55° DN□□		
MCLNR/L B246	MWLNR/L B246	MVJNR/L B247	MDJNR/L B247		MVVNN B248	MDPNN B249			
		60° TN□□	60° TN□□						
		MTJNR/L B248	MTJNR/L B248						
C Clamp- on			55° KNMX						60° TN□□
			CKJNR/L B256						CTGNR/L B256
H Retract- pin									
JT Back clamping	60° TN□□								60° TN□□
	JTTLNR/L B377								JTTANR/L B377

The page number for the product details is shown in red.



	Turning	Turning chamfering		Turning/Facing chamfering	Facing		Profiling	External profiling
	B-R 75° 	E 60° 	D 45° 	S 45° 	K 75° 	F 91° 	Q*1 · H*1 45° 	Special
	90° SN□□ ASBNR/L B213 80° CN□□ ACRNR/L B209		90° SN□□ ASDNN B214	90° SN□□ ASSNR/L B214	90° SN□□ ASKNR/L B215 80° CN□□ ACKNR/L B209	60° TN□□ ATFNR/L B215	55° DN□□ 35° VN□□ ADQNR/L AVQNR/L B206, B216 B207, B217 60° TN□□ 25° YNMG ATQNR/L AVQNR/L B216 B217	- RN□□ ARGNR/L B217
	90° SN□□ DSBNR/L B235		90° SN□□ DSDNN B235	90° SN□□ DSSNR/L B235	90° SN□□ DSKNR/L B236	60° TN□□ DTFNR/L B236	55° DN□□ DDQNR/L B237	- RN□□ DRGNR/L B237
				90° SNGD CSSNR/L B273 90° HNGD CHSNR/L B273				
	90° SN□□ PSBNR/L B241 100° CN□□ PCBNR/L B241		90° SN□□ PSDNN B242	90° SN□□ PSSNR/L B242	90° SN□□ PSKNR/L B243	60° TN□□ PTFNR/L B243 80° CN□□ PCFNR/L B244	55° DN□□ PDQNR/L B244 35° VN□□ PVQNR/L B221 25° YNMG PVQNR/L B221	- RNMG PRGNR/L B244
		60° TN□□ MTENN B249					35° VN□□ MVQNR/L B250 25° YNMG MVQNR/L B250 60° TN□□ MTQNR/L B250	
	90° SN□□ CSBNR/L B256		90° SN□□ CSDNN B257	90° SN□□ CSSNR/L B257	90° SN□□ CSKNR/L B257	60° TN□□ CTFNR/L B258		
	90° SNMM HSRNR/L B260							

Note:*1 marked Q and H style are Tungaloy Standard.



External Toolholder (Positive insert) - Quick Guide

	Turning Facing	External profiling				Turning			Turning Facing
	L 95°	J 93°	V 72.5°	N 62.5°	A 91°	G 91°	B-R 75°	X 20°	
X Double clamping screw-on/clamping									
P Lever lock								80° WPMT XWXPR/L B275	
C Clamp-on						60° TP CTGPR/L B258	90° SP CSBPR/L B258		
J Screw-on	80° CC JSCLCR/L B363	55° DC JSDJCR/L B367	55° DX JSDJXR B193 JSDJ2XR/L B192, B193, B227	35° VB JSVNB B374	55° DC JSDNCN B368	80° CC JSCACL B364	80° CC JSCGCR/L B365		
	80° CC JSCL2CR/L ² B362	55° DC JSDJ2CR/L ² B228, B365, B367	35° VX JSVJXR B195 JSVJ2XR/L B194, B195, B228		55° DC JSDN3CR/L ³ B368	60° TC JSTACR/L B370			
	35° VP JSVL2PR/L B375	35° VB JSVJBR/L B371				35° VB JSVABR/L B372			
	80° WX JSWLXR B191 JSWL2XR/L B190, B191, B227	35° VB JSVJ2BR/L B229, B371, B372							
S Screw-on	80° CC SCLCR/L B261	55° DC SDJCR/L B261		35° VC SVVCN B263	55° DC SDNCN B262	60° TC STACR/L B263			
		35° VC SVJCR/L B262							
		25° YW SYJBR/L B231							
JT Back clamping	80° CC JTCL2CR/L B362	55° DC JTDJ2CR/L B366				60° TC JTTACR/L B370			
T Taper-lock									

*2: L2 and J2: without offset

*3

The page number for the product details is shown in red.



Turning Chamfering	Turning / Facing Chamfering	Facing		Profiling			
D 45°	S 45°	F 91°	C 90°	Q*145° · H*17.5°	H 100°	I 76.5°	P 117.5°
90° □ SP□□ CSDPN B259	90° □ SP□□ CSSPR/L B259	60° △ TP□□ CTFPR/L B259	60° △ TP□□ CTCPR/L B260				
		55° ▽ DC□□ JSDFCR/L B369					35° ◁ VP□□ JSVP2PR/L B375
90° □ SC□□ SSDCN B266				35° ◁ VC□□ SVQCR/L B267	25° ◁ YWMT SYHBR/L B232	25° ◁ YWMT SYIBN B232	
90° □ SP□□ SSDPN *Tungaloy standard B266				55° ▽ DC□□ SDQCR/L B267			
				35° ◁ VCG□ SVHCR/L B267			
				25° ◁ YWMT SYQBR/L B231			

Note:*1 marked Q and H style are Tungaloy Standard.



External Toolholder (Positive insert) - Quick Guide

	External profiling	Back turning	Front turning / Reverse turning
	<p>Special</p>		
X Double clamping <small>screw-on/clamping</small>			
P Lever lock	<ul style="list-style-type: none"> - RCMT PRGCR/L B245 - RCMT PRDCN B245 		
C Clamp-on			
J Screw-on		 JSXBR/L B380 JSTBR/L B381 JS□□K-TBL3 B381 JSEGR/L B383	 JSXGR/L B379, B396 JS□□K-SDUCL B369 JS□□□-SDUXL B196 JS□□□-SVUXL B197
S Screw-on	<ul style="list-style-type: none"> - RCMT SRACR/L B264 - RCMT SRGCR/L B265, B269 - RCMT SRDCN B266, B269 	<p>Note: JSXBR/L type is also used for JXT-type threading inserts.</p>	<p>Note: JSXGR/L type is also used for JXG-type grooving inserts.</p>
JT Back clamping			
T Taper-lock	<ul style="list-style-type: none"> - RT□□ TRACN B268 - RT□□ TRDCN B268 		

The page number for the product details is shown in red.

MEMO



Ext. Toolholder

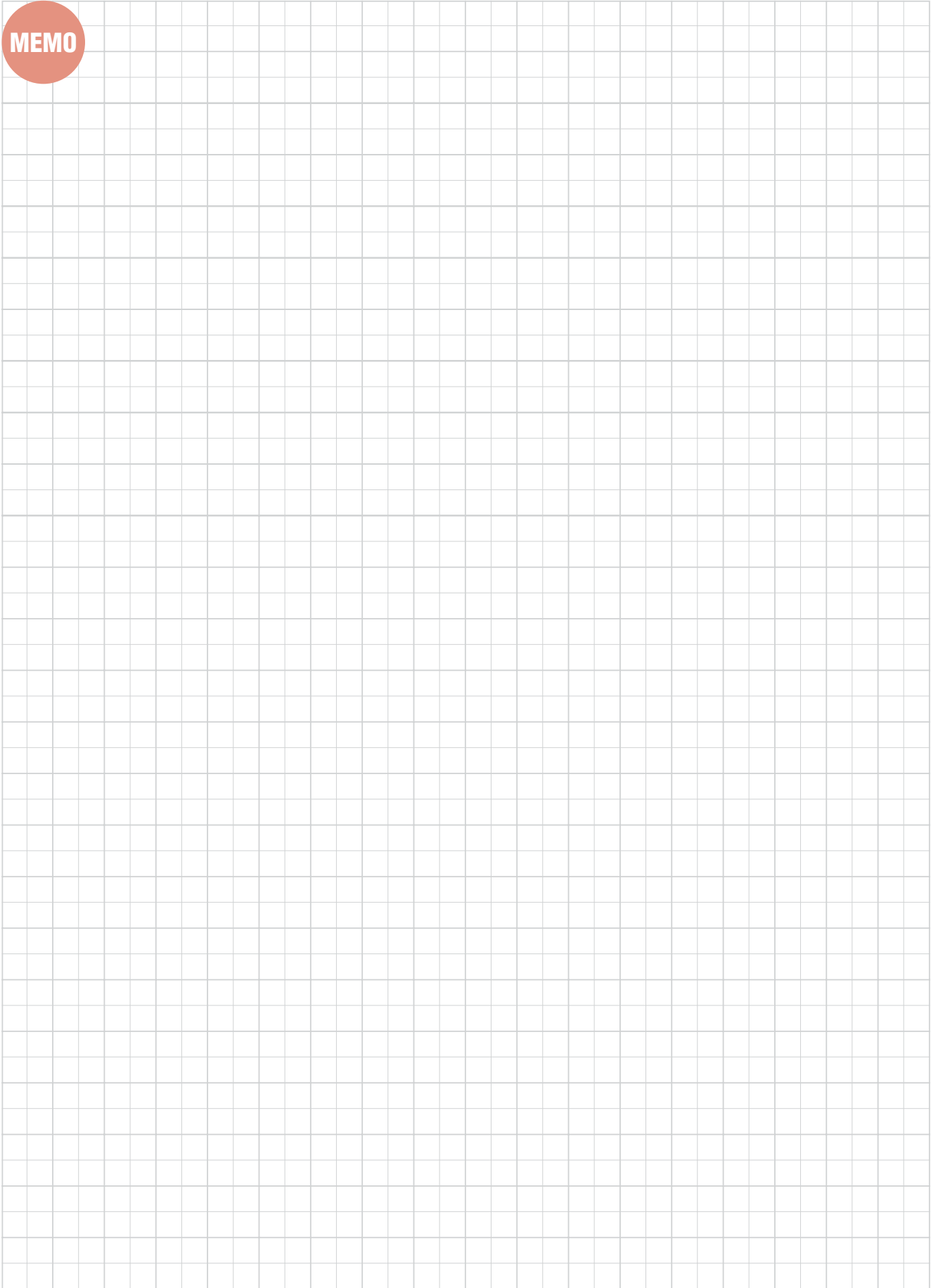



MINIFORCE

JSWL2XR/L

Screw-on toolholder without offset with 95° approach angle, for WXGU inserts

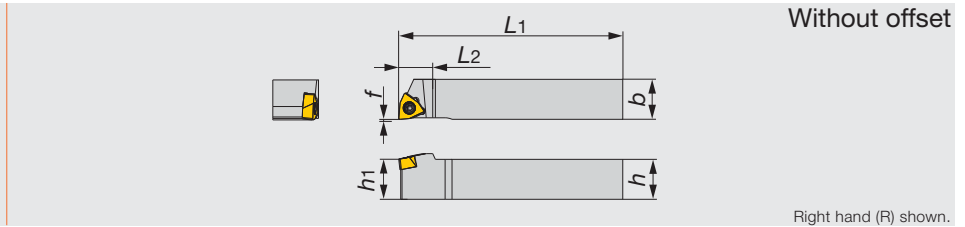
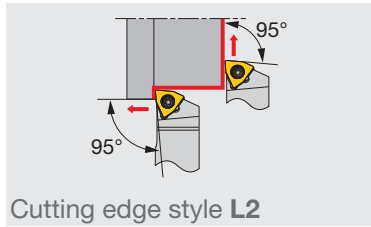

Inch	<i>h</i>	<i>b</i>	<i>L</i> ₁	<i>L</i> ₂	<i>h</i> ₁	<i>f</i>	<i>r</i> _ε **	Insert	Torque*
JSWL2XR/L062	0.375	0.375	4.750	0.500	0.375	0	0.008	WXGU22**/L/R...	0.66
JSWL2XR/L082	0.500	0.500	4.750	0.500	0.500	0	0.008	WXGU22**/L/R...	0.66
JSWL2XR/L102	0.625	0.625	4.750	0.500	0.625	0	0.008	WXGU22**/L/R...	0.66

Metric	<i>h</i>	<i>b</i>	<i>L</i> ₁	<i>L</i> ₂	<i>h</i> ₁	<i>f</i>	<i>r</i> _ε **	Insert	Torque*
JSWL2XR/L1010X04	10	10	120	11	10	0	0.2	WXGU0403**/L/R...	0.9
JSWL2XR/L1212F04	12	12	85	11	12	0	0.2	WXGU0403**/L/R...	0.9
JSWL2XR/L1212X04	12	12	120	11	12	0	0.2	WXGU0403**/L/R...	0.9
JSWL2XR/L1616X04	16	16	120	13	16	0	0.2	WXGU0403**/L/R...	0.9
JSWL2XR/L2020H04	20	20	100	13	20	0	0.2	WXGU0403**/L/R...	0.9

*Torque: Recommended torque (lbf-ft, N-m) for clamping ***r*_ε: Standard corner radius
 Note: Right-hand toolholders (R) are used with left-hand inserts (L). Left-hand toolholders (L) are used with right-hand inserts (R).

SPARE PARTS

Designation	Clamping screw	Wrench
JSWL2XR/L...	SR34-514	T-7F

MINIFORCE

JPWL2XR/L

Lever lock toolholder without offset with 95° approach angle, for WXGU inserts

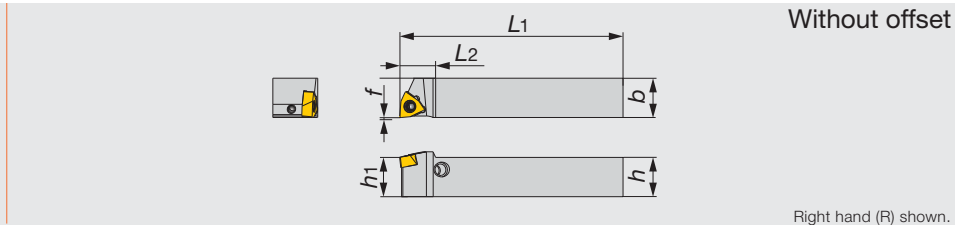
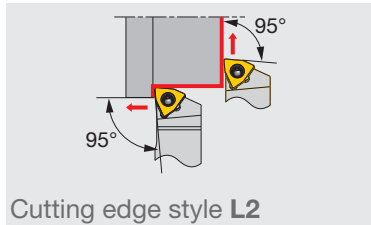

Inch	<i>h</i>	<i>b</i>	<i>L</i> ₁	<i>L</i> ₂	<i>h</i> ₁	<i>f</i>	<i>r</i> _ε **	Insert	Torque*
JPWL2XR/L062	0.375	0.375	4.750	0.500	0.375	0	0.008	WXGU22**/L/R...	0.66
JPWL2XR/L082	0.500	0.500	4.750	0.500	0.500	0	0.008	WXGU22**/L/R...	0.66
JPWL2XR/L102	0.625	0.625	4.750	0.500	0.625	0	0.008	WXGU22**/L/R...	0.66

Metric	<i>h</i>	<i>b</i>	<i>L</i> ₁	<i>L</i> ₂	<i>h</i> ₁	<i>f</i>	<i>r</i> _ε **	Insert	Torque*
JPWL2XR/L1010X04	10	10	120	11	10	0	0.2	WXGU0403**/L/R...	0.9
JPWL2XR/L1212F04	12	12	85	11	12	0	0.2	WXGU0403**/L/R...	0.9
JPWL2XR/L1212X04	12	12	120	11	12	0	0.2	WXGU0403**/L/R...	0.9
JPWL2XR/L1616X04	16	16	120	13	16	0	0.2	WXGU0403**/L/R...	0.9

*Torque: Recommended torque (lbf-ft, N-m) for clamping ***r*_ε: Standard corner radius
 Note: Right-hand toolholders (R) are used with left-hand inserts (L). Left-hand toolholders (L) are used with right-hand inserts (R).

SPARE PARTS

Designation	Lever	Pin	Clamping screw	Wrench
JPWL2XR/L...	SLLV-2	SL-PI-2	SR10400611	HW2.0/5RED

Reference pages

JSWL2XR/L, JPWL2XR/L: Inserts → **B198 -**, Standard cutting conditions → **B201**

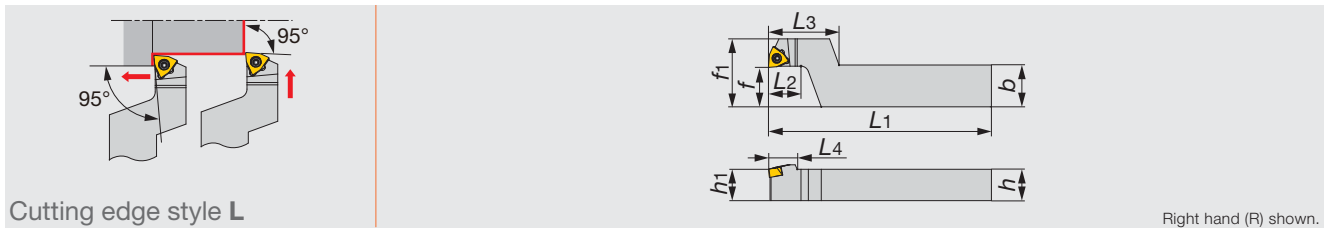

Inch	h	b	L1	L2	L3	L4	h1	f	f1	rε**	Insert	Torque*
JSWLXR082-F10	0.500	0.625	4.750	0.500	1.125	0.750	0.500	0.625	1.000	0.008	WXGU22**L...	0.66
JSWLXR102-F10	0.625	0.750	4.750	0.500	1.125	0.750	0.625	0.625	1.000	0.008	WXGU22**L...	0.66
Metric	h	b	L1	L2	L3	L4	h1	f	f1	rε**	Insert	Torque*
JSWLXR1016X04-F15	10	16	120	12	27	11	10	15	26	0.2	WXGU0403**L...	0.9
JSWLXR1216F04-F15	12	16	85	12	27	11	12	15	26	0.2	WXGU0403**L...	0.9
JSWLXR1216X04-F15	12	16	120	12	27	11	12	15	26	0.2	WXGU0403**L...	0.9
JSWLXR1620X04-F15	16	20	120	12	27	11	16	15	26	0.2	WXGU0403**L...	0.9

*Torque: Recommended torque (lbf-ft, N-m) for clamping **rε: Standard corner radius
 Note: Right-hand toolholders (R) are used with left-hand inserts (L).

SPARE PARTS

Designation	Clamping screw	Wrench
JSWLXR**-F...	SR34-514	T-7F

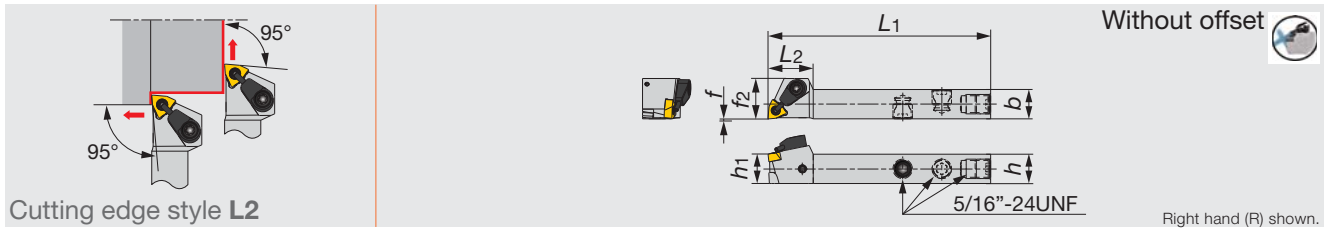

Inch	h	b	L1	L2	h1	f	f2	rε**	Insert	Torque*
JSWL2XR/L082-CHP	0.500	0.500	3.344	0.750	0.500	0	0.650	0.008	WXGU22**L/R...	0.66
Metric	h	b	L1	L2	h1	f	f2	rε**	Insert	Torque*
JSWL2XR/L1212F04-CHP	12	12	85	18	12	0	16.5	0.2	WXGU0403**L/R...	0.9

*Torque: Recommended torque (lbf-ft, N-m) for clamping **rε: Standard corner radius
 Note: Right-hand toolholders (R) are used with left-hand inserts (L). Left-hand toolholders (L) are used with right-hand inserts (R).

SPARE PARTS

Designation	Clamping screw	Coolant unit	Wrench
JSWL2XR/L**-CHP	SR34-514	S-CU-CHP	T-7F

Reference pages

JSWLXR-F, JSWL2XR/L-CHP: Inserts → B198, Standard cutting conditions → B201



MINIFORCE

JSDJ2XR/L

Screw-on toolholder without offset with 93° approach angle, for DXGU inserts

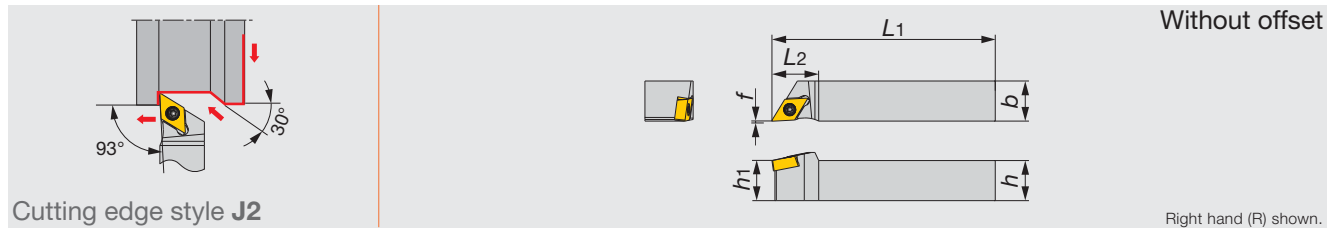

Inch	h	b	L1	L2	h1	f	re**	Insert	Torque*
JSDJ2XR/L062	0.375	0.375	4.750	0.625	0.375	0	0.008	DXGU22**L/R...	0.66
JSDJ2XR/L082	0.500	0.500	4.750	0.625	0.500	0	0.008	DXGU22**L/R...	0.66
JSDJ2XR/L102	0.625	0.625	4.750	0.625	0.625	0	0.008	DXGU22**L/R...	0.66

Metric	h	b	L1	L2	h1	f	re**	Insert	Torque*
JSDJ2XR/L1010X07	10	10	120	14	10	0	0.2	DXGU0703**L/R...	0.9
JSDJ2XR/L1212F07	12	12	85	14	12	0	0.2	DXGU0703**L/R...	0.9
JSDJ2XR/L1212X07	12	12	120	14	12	0	0.2	DXGU0703**L/R...	0.9
JSDJ2XR/L1616X07	16	16	120	18	16	0	0.2	DXGU0703**L/R...	0.9
JSDJ2XR/L2020H07	20	20	100	18	20	0	0.2	DXGU0703**L/R...	0.9

*Torque: Recommended torque (lbf-ft, N-m) for clamping **re: Standard corner radius

Note: Right-hand toolholders (R) are used with left-hand inserts (L). Left-hand toolholders (L) are used with right-hand inserts (R).

SPARE PARTS

Designation	Clamping screw	Wrench
JSDJ2XR/L...	SR34-514	T-7F

MINIFORCE

JPDJ2XR/L

Lever lock toolholder without offset with 93° approach angle, for DXGU inserts

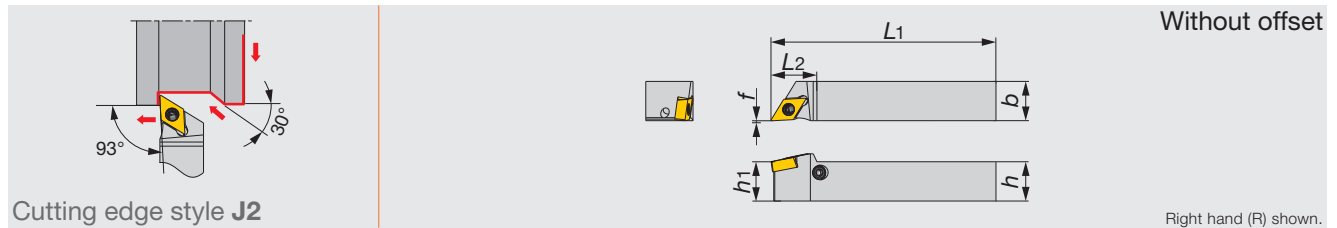

Inch	h	b	L1	L2	h1	f	re**	Insert	Torque*
JPDJ2XR/L062	0.375	0.375	4.750	0.625	0.375	0	0.008	DXGU22**L/R...	0.66
JPDJ2XR/L082	0.500	0.500	4.750	0.625	0.500	0	0.008	DXGU22**L/R...	0.66
JPDJ2XR/L102	0.625	0.625	4.750	0.625	0.625	0	0.008	DXGU22**L/R...	0.66

Metric	h	b	L1	L2	h1	f	re**	Insert	Torque*
JPDJ2XR/L1010X07	10	10	120	14	10	0	0.2	DXGU0703**L/R...	0.9
JPDJ2XR/L1212F07	12	12	85	14	12	0	0.2	DXGU0703**L/R...	0.9
JPDJ2XR/L1212X07	12	12	120	14	12	0	0.2	DXGU0703**L/R...	0.9
JPDJ2XR/L1616X07	16	16	120	18	16	0	0.2	DXGU0703**L/R...	0.9

*Torque: Recommended torque (lbf-ft, N-m) for clamping **re: Standard corner radius

Note: Right-hand toolholders (R) are used with left-hand inserts (L). Left-hand toolholders (L) are used with right-hand inserts (R).

SPARE PARTS

Designation	Lever	Pin	Clamping screw	Wrench
JPDJ2XR/L...	SLLV-2	SL-PI-2	SR10400611	HW2.0/5RED

Reference pages

JSDJ2XR/L, JPDJ2XR/L: Inserts → **B199** -, Standard cutting conditions → **B201**

Screw-on stepped-head toolholder with 93° approach angle, for DXGU inserts

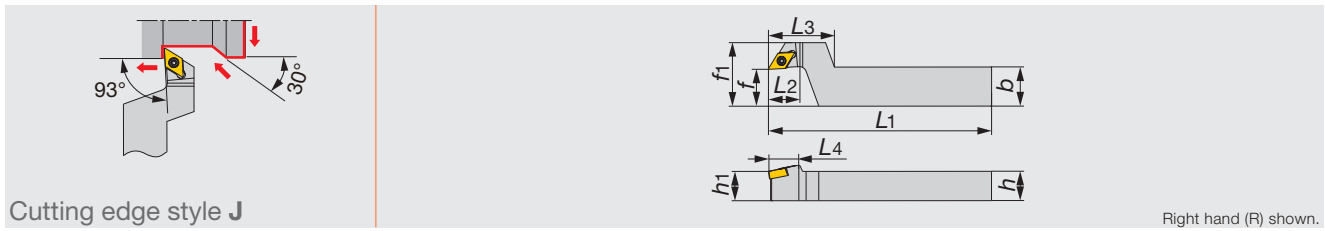

Inch	h	b	L1	L2	L3	L4	h1	f	f1	r _ε **	Insert	Torque*
JSDJXR082-F10	0.500	0.625	4.750	0.500	1.125	0.625	0.500	0.625	1.000	0.008	DXGU22**L...	0.66
JSDJXR102-F10	0.625	0.750	4.750	0.500	1.125	0.625	0.625	0.625	1.000	0.008	DXGU22**L...	0.66
Metric	h	b	L1	L2	L3	L4	h1	f	f1	r _ε **	Insert	Torque*
JSDJXR1016X07-F15	10	16	120	12	27	14	10	15	26	0.2	DXGU0703**L...	0.9
JSDJXR1216F07-F15	12	16	85	12	27	14	12	15	26	0.2	DXGU0703**L...	0.9
JSDJXR1216X07-F15	12	16	120	12	27	14	12	15	26	0.2	DXGU0703**L...	0.9
JSDJXR1620X07-F15	16	20	120	12	27	14	16	15	26	0.2	DXGU0703**L...	0.9

*Torque: Recommended torque (lbf-ft, N-m) for clamping **r_ε: Standard corner radius
 Note: Right-hand toolholders (R) are used with left-hand inserts (L).

SPARE PARTS

Designation	Clamping screw	Wrench
JSDJXR**-F...	SR34-514	T-7F

Screw-on toolholder without offset with 93° approach angle, for DXGU inserts, with channels for high pressure coolant

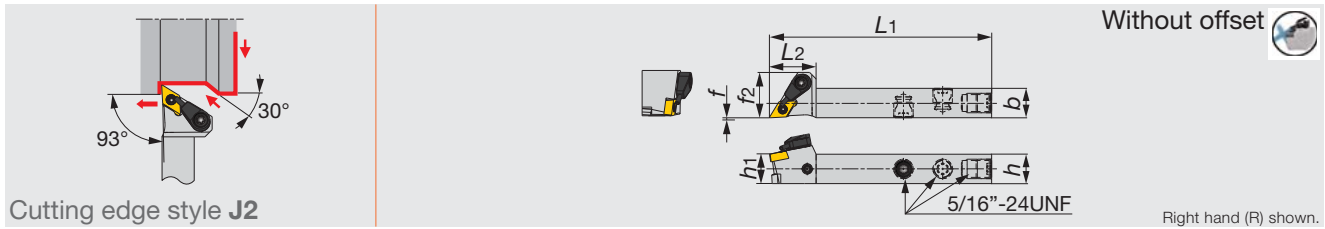

Inch	h	b	L1	L2	h1	f	f2	r _ε **	Insert	Torque*
JSDJ2XR/L082-CHP	0.500	0.500	3.344	0.750	0.500	0	0.730	0.008	DXGU22**L/R...	0.66
Metric	h	b	L1	L2	h1	f	f2	r _ε **	Insert	Torque*
JSDJ2XR/L1212F07-CHP	12	12	85	19	12	0	18.5	0.2	DXGU0703**L/R...	0.9

*Torque: Recommended torque (lbf-ft, N-m) for clamping **r_ε: Standard corner radius
 Note: Right-hand toolholders (R) are used with left-hand inserts (L). Left-hand toolholders (L) are used with right-hand inserts (R).

SPARE PARTS

Designation	Clamping screw	Coolant unit	Wrench
JSDJ2XR/L*-CHP	SR34-514	S-CU-CHP	T-7F

Reference pages

JSDJXR-F, JSDJ2XR/L-CHP: Inserts → B199 -, Standard cutting conditions → B201



MINIFORCE

JSVJ2XR/L

Screw-on toolholder without offset with 93° approach angle, for VXGU inserts

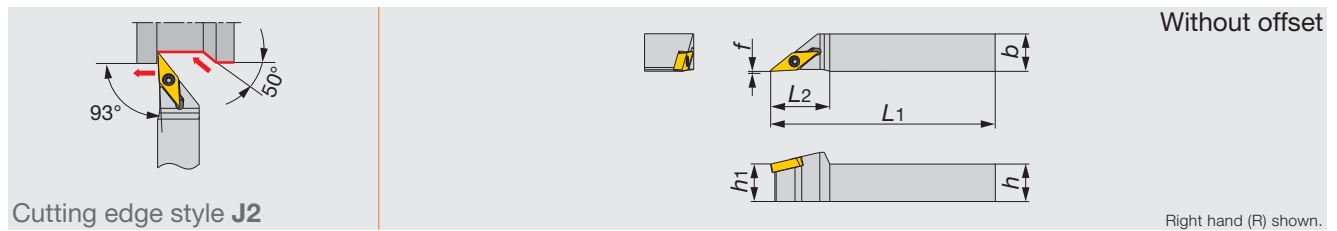

Inch	h	b	L1	L2	h1	f	re**	Insert	Torque*
JSVJ2XR/L067	0.375	0.375	4.750	0.669	0.375	0	0.008	VXGU73.5**L/R...	0.66
JSVJ2XR/L087	0.500	0.500	4.750	0.748	0.500	0	0.008	VXGU73.5**L/R...	0.66
JSVJ2XR/L107	0.625	0.625	4.750	0.748	0.625	0	0.008	VXGU73.5**L/R...	0.66

Metric	h	b	L1	L2	h1	f	re**	Insert	Torque*
JSVJ2XR/L1010X09	10	10	120	17	10	0	0.2	VXGU09T2**L/R...	0.9
JSVJ2XR/L1212F09	12	12	85	19	12	0	0.2	VXGU09T2**L/R...	0.9
JSVJ2XR/L1212X09	12	12	120	19	12	0	0.2	VXGU09T2**L/R...	0.9
JSVJ2XR/L1616X09	16	16	120	19	16	0	0.2	VXGU09T2**L/R...	0.9
JSVJ2XR/L2020H09	20	20	100	19	20	0	0.2	VXGU09T2**L/R...	0.9

*Torque: Recommended torque (lbf-ft, N-m) for clamping **re: Standard corner radius

Note: Right-hand toolholders (R) are used with left-hand inserts (L). Left-hand toolholders (L) are used with right-hand inserts (R).

SPARE PARTS

Designation	Clamping screw	Wrench
JSVJ2XR/L...	SR34-508	T-7F

MINIFORCE

JPVJ2XR/L

Lever lock toolholder without offset with 93° approach angle, for VXGU inserts

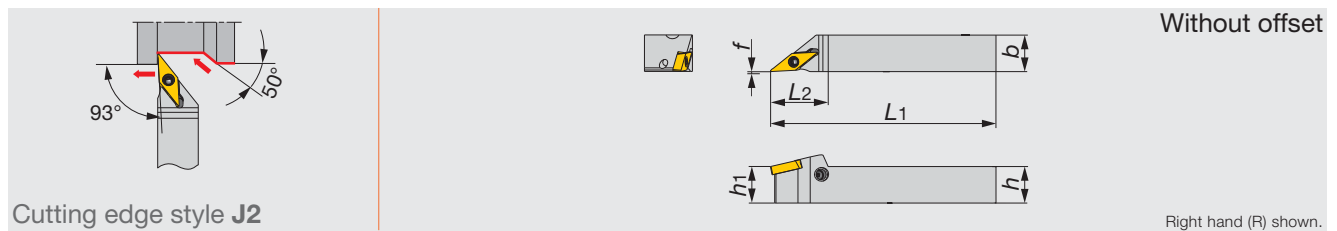

Inch	h	b	L1	L2	h1	f	re**	Insert	Torque*
JPVJ2XR/L067	0.375	0.375	4.750	0.669	0.375	0	0.008	VXGU73.5**L/R...	0.66
JPVJ2XR/L087	0.500	0.500	4.750	0.748	0.500	0	0.008	VXGU73.5**L/R...	0.66
JPVJ2XR/L107	0.625	0.625	4.750	0.748	0.625	0	0.008	VXGU73.5**L/R...	0.66

Metric	h	b	L1	L2	h1	f	re**	Insert	Torque*
JPVJ2XR/L1010X09	10	10	120	19	10	0	0.2	VXGU09T2**L/R...	0.9
JPVJ2XR/L1212F09	12	12	85	19	12	0	0.2	VXGU09T2**L/R...	0.9
JPVJ2XR/L1212X09	12	12	120	19	12	0	0.2	VXGU09T2**L/R...	0.9
JPVJ2XR/L1616X09	16	16	120	19	16	0	0.2	VXGU09T2**L/R...	0.9

*Torque: Recommended torque (lbf-ft, N-m) for clamping **re: Standard corner radius

Note: Right-hand toolholders (R) are used with left-hand inserts (L). Left-hand toolholders (L) are used with right-hand inserts (R).

SPARE PARTS

Designation	Lever	Pin	Clamping screw	Wrench
JPVJ2XR/L...	SLLV-1	SL-PI-2	SR10400611	HW2.0/5RED

Reference pages

JSVJ2XR/L, JPVJ2XR/L: Inserts → B200, Standard cutting conditions → B201

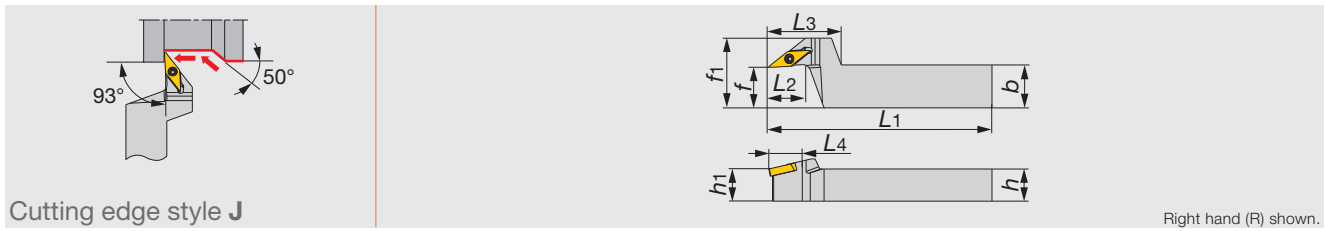

Inch	h	b	L1	L2	L3	L4	h1	f	f1	rε**	Insert	Torque*
JSVJXR087-F10	0.500	0.625	4.750	0.500	1.125	0.750	0.500	0.625	1.000	0.008	VXGU73.5**L...	0.66
JSVJXR107-F10	0.625	0.750	4.750	0.500	1.125	0.750	0.500	0.625	1.000	0.008	VXGU73.5**L...	0.66

Metric	h	b	L1	L2	L3	L4	h1	f	f1	rε**	Insert	Torque*
JSVJXR1016X09-F15	10	16	120	12	27	19	10	15	26	0.2	VXGU09T2**L...	0.9
JSVJXR1216F09-F15	12	16	85	12	27	19	12	15	26	0.2	VXGU09T2**L...	0.9
JSVJXR1216X09-F15	12	16	120	12	27	19	12	15	26	0.2	VXGU09T2**L...	0.9
JSVJXR1620X09-F15	16	20	120	12	27	19	16	15	26	0.2	VXGU09T2**L...	0.9

*Torque: Recommended torque (lbf-ft, N-m) for clamping **rε: Standard corner radius
 Note: Right-hand toolholders (R) are used with left-hand inserts (L).

SPARE PARTS

Designation	Clamping screw	Wrench
JSVJXR**-F...	SR34-508	T-7F

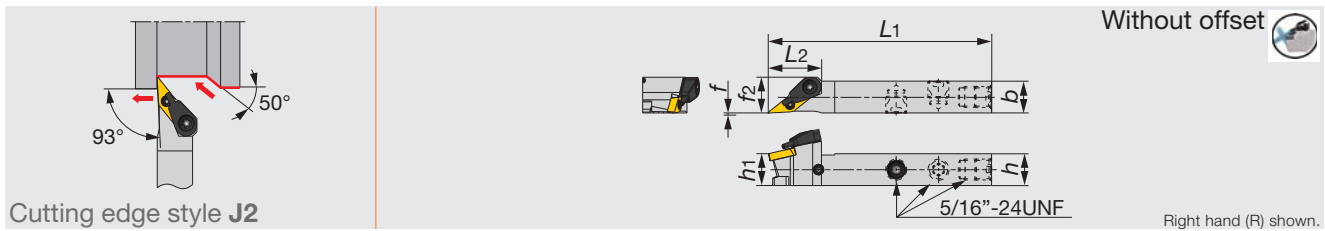

Inch	h	b	L1	L2	h1	f	f2	rε**	Insert	Torque*
JSVJ2XR/L087-CHP	0.500	0.500	4.750	0.748	0.500	0	0.531	0.008	VXGU73.5**L/R...	0.66

Metric	h	b	L1	L2	h1	f	f2	rε**	Insert	Torque*
JSVJ2XR/L1212F09-CHP	12	12	85	20	12	0	13.5	0.2	VXGU09T2**L/R...	0.9

*Torque: Recommended torque (lbf-ft, N-m) for clamping **rε: Standard corner radius
 Note: Right-hand toolholders (R) are used with left-hand inserts (L). Left-hand toolholders (L) are used with right-hand inserts (R).

SPARE PARTS

Designation	Clamping screw	Coolant unit	Wrench
JSVJ2XR/L**-CHP	SR34-508	S-CU-CHP	T-7F



MINIFORCE

JS-SDUXL

Screw-on toolholder with 93° approach angle, for DXGU inserts

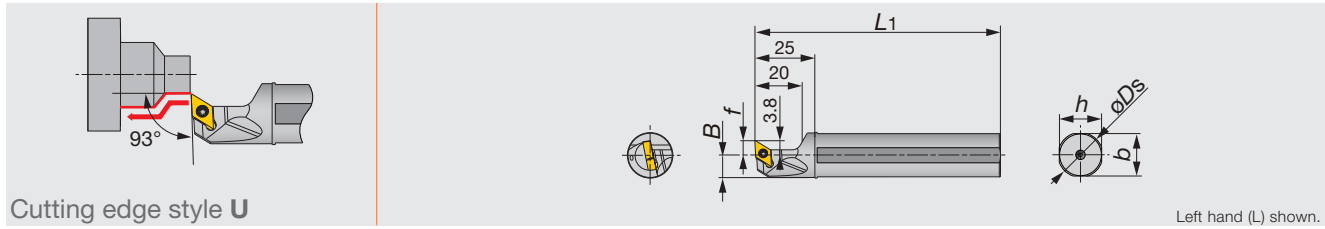

Inch	øDs	f	L1	h	b	B	r _e **	Insert	Torque*
JS159F-SDUXL07	0.625	0.236	3.346	0.591	0.591	0.303	0.008	DXGU22**L...	0.66
JS19G-SDUXL07	0.750	0.236	3.543	0.709	0.709	0.366	0.008	DXGU22**L...	0.66
JS19X-SDUXL07	0.750	0.236	4.724	0.709	0.709	0.366	0.008	DXGU22**L...	0.66
JS254X-SDUXL07	1.000	0.394	4.724	0.945	0.945	0.492	0.008	DXGU22**L...	0.66
Metric	øDs	f	L1	h	b	B	r _e **	Insert	Torque*
JS14H-SDUXL07	14	6	100	13	6.75	6.75	0.2	DXGU0703**L...	0.9
JS159F-SDUXL07	15.875	6	85	15	7.687	7.687	0.2	DXGU0703**L...	0.9
JS16F-SDUXL07	16	6	85	15	7.75	7.75	0.2	DXGU0703**L...	0.9
JS19G-SDUXL07	19.05	6	90	18	9.275	9.275	0.2	DXGU0703**L...	0.9
JS19X-SDUXL07	19.05	6	120	18	9.275	9.275	0.2	DXGU0703**L...	0.9
JS20G-SDUXL07	20	6	90	19	9.75	9.75	0.2	DXGU0703**L...	0.9
JS20X-SDUXL07	20	6	120	19	9.75	9.75	0.2	DXGU0703**L...	0.9
JS22X-SDUXL07	22	10	120	21	10.75	10.75	0.2	DXGU0703**L...	0.9
JS25H-SDUXL07	25	10	100	24	12.25	12.25	0.2	DXGU0703**L...	0.9
JS254X-SDUXL07	25.4	10	120	24	12.45	12.45	0.2	DXGU0703**L...	0.9

*Torque: Recommended torque (lbf-ft, N-m) for clamping **r_e: Standard corner radius
 Note: Left-hand toolholders (L) are used with left-hand inserts (L).

SPARE PARTS



Designation	Clamping screw	Wrench
JS**-SDUXL07	SR34-514	T-7F

Reference pages

JS-SDUXL: Inserts → **B199** -, Standard cutting conditions → **B201**

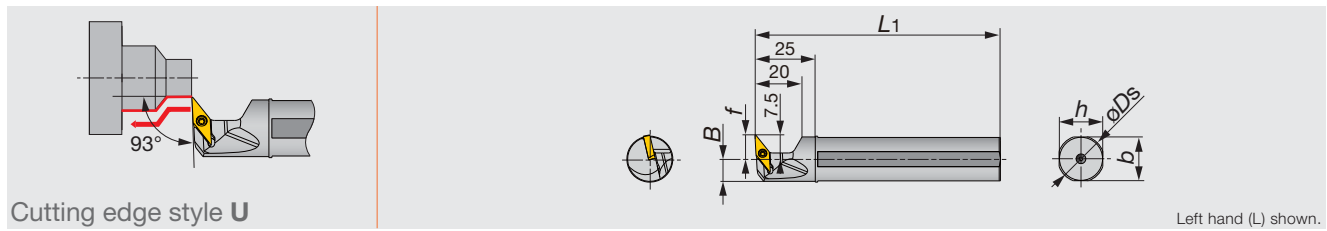

Inch	ϕD_s	f	L_1	h	b	B	r_{ϵ}^{**}	Insert	Torque*
JS159F-SVUXL09	0.625	0.394	3.346	0.591	0.591	0.303	0.008	VXGU73.5**L...	0.66
JS19G-SVUXL09	0.750	0.394	3.543	0.709	0.709	0.362	0.008	VXGU73.5**L...	0.66
JS19X-SVUXL09	0.750	0.394	4.724	0.709	0.709	0.362	0.008	VXGU73.5**L...	0.66
JS254X-SVUXL09	1.000	0.394	4.724	0.945	0.945	0.488	0.008	VXGU73.5**L...	0.66
Metric	ϕD_s	f	L_1	h	b	B	r_{ϵ}^{**}	Insert	Torque*
JS159F-SVUXL09	15.875	10	85	15	7.7	7.7	0.2	VXGU09T2**L...	0.9
JS16F-SVUXL09	16	10	85	15	7.7	7.7	0.2	VXGU09T2**L...	0.9
JS19G-SVUXL09	19.05	10	90	18	9.2	9.2	0.2	VXGU09T2**L...	0.9
JS19X-SVUXL09	19.05	10	120	18	9.2	9.2	0.2	VXGU09T2**L...	0.9
JS20G-SVUXL09	20	10	90	19	9.7	9.7	0.2	VXGU09T2**L...	0.9
JS20X-SVUXL09	20	10	120	19	9.7	9.7	0.2	VXGU09T2**L...	0.9
JS22X-SVUXL09	22	10	120	21	10.7	10.7	0.2	VXGU09T2**L...	0.9
JS25H-SVUXL09	25	10	100	24	12.2	12.2	0.2	VXGU09T2**L...	0.9
JS254X-SVUXL09	25.4	10	120	24	12.4	12.4	0.2	VXGU09T2**L...	0.9

*Torque: Recommended torque (lbf-ft, N-m) for clamping ** r_{ϵ} : Standard corner radius
Note: Left-hand toolholders (L) are used with left-hand inserts (L).

SPARE PARTS

Designation	Clamping screw	Wrench
JS**-SVUXL09	SR34-508	T-7F

Reference pages

JS-SVUXL: Inserts → B200, Standard cutting conditions → B201

● : Continuous cutting
 ● : Light interrupted cutting
 ✱ : Heavy interrupted cutting

INSERT

**POSITIVE TYPE
 DOUBLE-SIDED**



**Trigon, 80°
 with hole**

P	Steel	●	●	●	●	●														
M	Stainless	●	●	●	●	●														
K	Cast iron	●		●	●	●				●										
N	Non-ferrous									●										
S	Superalloys	●								●										
H	Hard materials																			

Application	Chipbreaker	Designation		Corner radius	Coated		Coated cermet	Cermet	Uncoated															
		Inch	Metric		AH725	SH725	GT9530	NS9530	KS05F															
Finishing to medium cutting (Sharp edge)		JTS	WXGU 220 MFR-JTS	WXGU040301MFR-JTS	<0.004**	●																		
			WXGU 220 MFL-JTS	WXGU040301MFL-JTS	<0.004**	●																		
			WXGU 220.5 MFR-JTS	WXGU040302MFR-JTS	<0.008**	●																		
			WXGU 220.5 MFL-JTS	WXGU040302MFL-JTS	<0.008**	●																		
Finishing to medium cutting		JTS	WXGU 220 MR-JTS	WXGU040301MR-JTS	<0.004**	●																		
			WXGU 220 ML-JTS	WXGU040301ML-JTS	<0.004**	●																		
			WXGU 220.5 MR-JTS	WXGU040302MR-JTS	<0.008**	●																		
			WXGU 220.5 ML-JTS	WXGU040302ML-JTS	<0.008**	●																		
Finishing (Low cutting force) (Sharp edge)		JSS	WXGU 220 MFR-JSS	WXGU040301MFR-JSS	<0.004**	●																		
			WXGU 220 MFL-JSS	WXGU040301MFL-JSS	<0.004**	●																		
			WXGU 220.5 MFR-JSS	WXGU040302MFR-JSS	<0.008**	●																		
			WXGU 220.5 MFL-JSS	WXGU040302MFL-JSS	<0.008**	●																		
Finishing (Low cutting force)		JSS	WXGU 220 MR-JSS	WXGU040301MR-JSS	<0.004**	●																		
			WXGU 220 ML-JSS	WXGU040301ML-JSS	<0.004**	●																		
			WXGU 220.5 MR-JSS	WXGU040302MR-JSS	<0.008**	●																		
			WXGU 220.5 ML-JSS	WXGU040302ML-JSS	<0.008**	●																		
Finishing to medium cutting		TS	WXGU 220.5 R TS	WXGU040302R-TS	0.008"	●		●	●	●														
			WXGU 220.5 L TS	WXGU040302L-TS	0.008"	●		●	●	●														
			WXGU 221 R TS	WXGU040304R-TS	0.016"	●		●	●	●														
			WXGU 221 L TS	WXGU040304L-TS	0.016"	●		●	●	●														
			WXGU 222 R TS	WXGU040308R-TS	0.031"	●		●	●	●														
			WXGU 222 L TS	WXGU040308L-TS	0.031"	●		●	●	●														
Finishing (Wiper)		TSW	WXGU 221 R TSW	WXGU040304R-TSW	0.016"	●		●	●															
			WXGU 221 L TSW	WXGU040304L-TSW	0.016"	●		●	●	●														
			WXGU 222 R TSW	WXGU040308R-TSW	0.031"	●		●	●	●														
			WXGU 222 L TSW	WXGU040308L-TSW	0.031"	●		●	●	●														
Finishing (Low cutting force)		SS	WXGU 220.5 R SS	WXGU040302R-SS	0.008"	●		●	●	●														
			WXGU 220.5 L SS	WXGU040302L-SS	0.008"	●		●	●	●														
			WXGU 221 R SS	WXGU040304R-SS	0.016"	●		●	●	●														
			WXGU 221 L SS	WXGU040304L-SS	0.016"	●		●	●	●														

* Corner radius has minus tolerance.

● : Line up

INSERT

**POSITIVE TYPE
DOUBLE-SIDED**

**Rhombic, 55°
with hole**



- : Continuous cutting
- : Light interrupted cutting
- ✱ : Heavy interrupted cutting

P	Steel	●	●	●																																					
M	Stainless	●	●	●																																					
K	Cast iron	●																																							
N	Non-ferrous																																								
S	Superalloys	●																																							
H	Hard materials																																								

Application	Chipbreaker	Designation		Corner radius	Coated																																							
		Inch	Metric		AH725	SH725																																						
Finishing (Sharp edge)		JRP	DXGU 220-MFRE-JRP	DXGU070301MFRE-JRP	<0.004**	●	●																																					
			DXGU 220-MFLE-JRP	DXGU070301MFLE-JRP	<0.004**	●	●																																					
			DXGU 220.5-MFRE-JRP	DXGU070302MFRE-JRP	<0.008**	●	●																																					
			DXGU 220.5-MFLE-JRP	DXGU070302MFLE-JRP	<0.008**	●	●																																					
Finishing to medium cutting (Sharp edge)		JTS	DXGU 220-MFR-JTS	DXGU070301MFR-JTS	<0.004**	●	●																																					
			DXGU 220-MFL-JTS	DXGU070301MFL-JTS	<0.004**	●	●																																					
			DXGU 220.5-MFR-JTS	DXGU070302MFR-JTS	<0.008**	●	●																																					
			DXGU 220.5-MFL-JTS	DXGU070302MFL-JTS	<0.008**	●	●																																					
Finishing to medium cutting		JTS	DXGU 220-MR-JTS	DXGU070301MR-JTS	<0.004**	●	●																																					
			DXGU 220-ML-JTS	DXGU070301ML-JTS	<0.004**	●	●																																					
			DXGU 220.5-MR-JTS	DXGU070302MR-JTS	<0.008**	●	●																																					
			DXGU 220.5-ML-JTS	DXGU070302ML-JTS	<0.008**	●	●																																					
Finishing (Low cutting force) (Sharp edge)		JSS	DXGU 220-MFR-JSS	DXGU070301MFR-JSS	<0.004**	●	●																																					
			DXGU 220-MFL-JSS	DXGU070301MFL-JSS	<0.004**	●	●																																					
			DXGU 220.5-MFR-JSS	DXGU070302MFR-JSS	<0.008**	●	●																																					
			DXGU 220.5-MFL-JSS	DXGU070302MFL-JSS	<0.008**	●	●																																					

* Corner radius has minus tolerance.

● : Line up



- : Continuous cutting
- ◐ : Light interrupted cutting
- ⚡ : Heavy interrupted cutting

POSITIVE TYPE DOUBLE-SIDED



Material	Coated	Coated cermet	Cermet	Uncoated
P Steel	◐	●	●	
M Stainless	◐			
K Cast iron	◐	●	●	●
N Non-ferrous				●
S Superalloys	●			●
H Hard materials				

Application	Chipbreaker	Designation		Corner radius	Coated	Coated cermet	Cermet	Uncoated
		Inch	Metric		AH725	GT9530	NS9530	KS05F
Finishing (Low cutting force)		JSS DXGU 220 MR-JSS	DXGU070301MR-JSS	<0.004**	●			
		DXGU 220 ML-JSS	DXGU070301ML-JSS	<0.004**	●			
		DXGU 220.5 MR-JSS	DXGU070302MR-JSS	<0.008**	●			
		DXGU 220.5 ML-JSS	DXGU070302ML-JSS	<0.008**	●			
Finishing to medium cutting		TS DXGU 220.5 TS	DXGU070302R-TS	0.008"	●	●	●	●
		DXGU 220.5 TS	DXGU070302L-TS	0.008"	●	●	●	●
		DXGU 221 TS	DXGU070304R-TS	0.016"	●	●	●	●
		DXGU 221 TS	DXGU070304L-TS	0.016"	●	●	●	●
		DXGU 222 TS	DXGU070308R-TS	0.031"	●	●	●	●
		DXGU 222 TS	DXGU070308L-TS	0.031"	●	●	●	●
Finishing (Low cutting force)		SS DXGU 220.5 SS	DXGU070302R-SS	0.008"	●	●	●	●
		DXGU 220.5 SS	DXGU070302L-SS	0.008"	●	●	●	●
		DXGU 221 SS	DXGU070304R-SS	0.016"	●	●	●	●
		DXGU 221 SS	DXGU070304L-SS	0.016"	●	●	●	●

* Corner radius has minus tolerance.

POSITIVE TYPE DOUBLE-SIDED



Material	Coated
P Steel	●
M Stainless	●
K Cast iron	
N Non-ferrous	
S Superalloys	
H Hard materials	

Application	Chipbreaker	Designation		Corner radius	Coated
		Inch	Metric		SH725
Finishing (Sharp edge)		JRP VXGU 73.50 MFRE-JRP	VXGU09T201MFRE-JRP	<0.004**	●
		VXGU 73.50 MFLE-JRP	VXGU09T201MFLE-JRP	<0.004**	●
		VXGU 73.50.5 MFRE-JRP	VXGU09T202MFRE-JRP	<0.008**	●
		VXGU 73.50.5 MFLE-JRP	VXGU09T202MFLE-JRP	<0.008**	●

* Corner radius has minus tolerance.

● : Line up

STANDARD CUTTING CONDITIONS
FOR EXTERNAL TURNING



Ext. Toolholder

Applications	ISO	Workpiece material	Priority	Chip-breaker	Grade	Cutting speed Vc (sfm)	Depth of cut ap (in)	Feed f (ipr)
For swiss type automatic lathes	P	Low carbon steels Carbon steels (1045, etc.) Low alloy steels Alloy steels (4140, etc.)	With high sharpness	JSS	SH725	160 - 590	0.004 - 0.060	0.001 - 0.004
			First choice	JTS	AH725	160 - 590	0.004 - 0.080	0.001 - 0.004
	M	Stainless steels (Austenitic) (304, etc.) Stainless steels (Martensitic and ferritic) (430, etc.) Stainless steels (Precipitation hardened) (174, etc.)	First choice	JSS	SH725	160 - 590	0.004 - 0.060	0.001 - 0.004
			For impact resistance	JTS	AH725	160 - 590	0.004 - 0.080	0.001 - 0.004
For small size CNC lathes	P	Low carbon steels Carbon steels (1045, etc.) Low alloy steels Alloy steels (4140, etc.)	First choice	SS	AH725	160 - 590	0.006 - 0.060	0.002 - 0.008
				TS	AH725	160 - 590	0.012 - 0.080	0.003 - 0.012
			For improved surface finish	SS	NS9530	260 - 660	0.006 - 0.060	0.002 - 0.008
				TS	NS9530	260 - 660	0.012 - 0.080	0.003 - 0.012
		For wear resistance	SS	GT9530	260 - 820	0.006 - 0.060	0.002 - 0.008	
		TS	GT9530	260 - 820	0.012 - 0.080	0.003 - 0.012		
	M	Stainless steels (Austenitic) (304, etc.) Stainless steels (Martensitic and ferritic) (430, etc.) Stainless steels (Precipitation hardened) (174, etc.)	First choice	SS	AH725	160 - 490	0.006 - 0.060	0.002 - 0.008
For impact resistance			TS	AH725	160 - 490	0.012 - 0.080	0.003 - 0.012	



ISO ETURN

ACLNR/L-Eco

Double-clamp toolholder with 95° approach angle, for negative 80° rhombic inserts

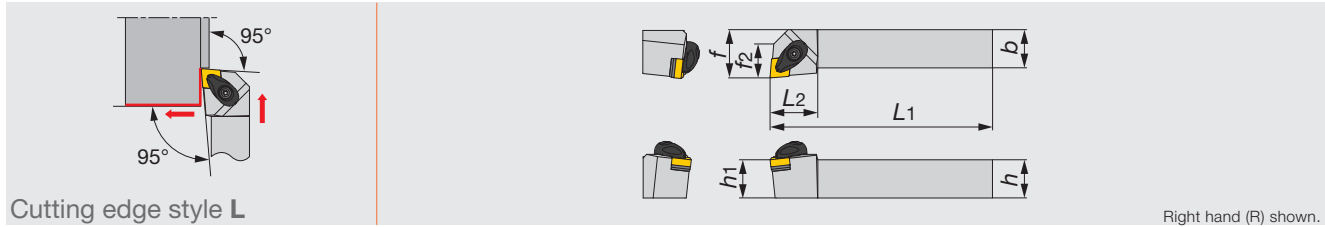

Inch	h	b	L_1	L_2	h_1	f	f_2	$r_{e^{**}}$	Insert	Torque*
ACLNR/L1233-A	0.750	0.750	4.500	0.900	0.750	1.000	0.625	0.031	CN**33...	2.2
ACLNR/L1633-A	1.000	1.000	6.000	1.000	1.000	1.250	0.750	0.031	CN**33...	2.2

Metric	h	b	L_1	L_2	h_1	f	f_2	$r_{e^{**}}$	Insert	Torque*
ACLNR/L2020K0904-A	20	20	125	25	20	25	18	0.8	CN**0904...	3
ACLNR/L2525M0904-A	25	25	150	25	25	32	18	0.8	CN**0904...	3

*Torque: Recommended torque (lbf-ft, N-m) for clamping ** r_e : Standard corner radius

SPARE PARTS

Designation	Clamp	Clamp screw	Spring	Spring pin	Shim	Shim screw	Wrench
ACLNR/L**-A	ACP3S-E	ACS-5W	BP-7	SP-2.5	ASC322	CSTB-3.5	T-15F

ISO ETURN

AWLNR/L-Eco

Double-clamp toolholder with 95° approach angle, for negative trigon inserts

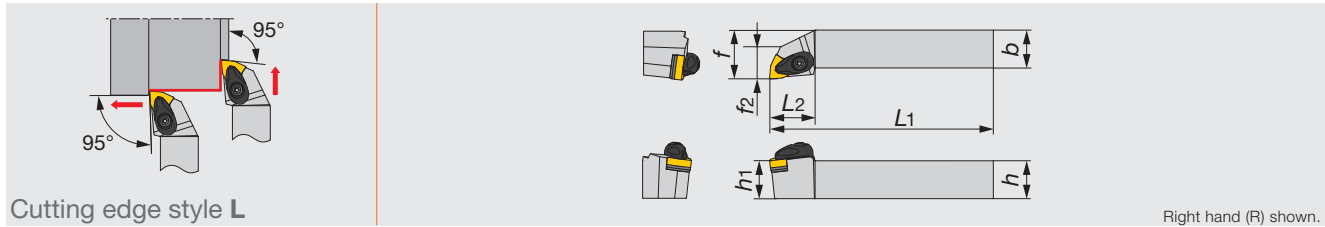

Inch	h	b	L_1	L_2	h_1	f	f_2	$r_{e^{**}}$	Insert	Torque*
AWLNR/L1233-A	0.750	0.750	4.500	1.125	0.750	1.000	0.625	0.031	WN**33...	2.2
AWLNR/L1633-A	1.000	1.000	6.000	1.125	1.000	1.250	0.875	0.031	WN**33...	2.2

Metric	h	b	L_1	L_2	h_1	f	f_2	$r_{e^{**}}$	Insert	Torque*
AWLNR/L2020K0604-A	20	20	125	27	20	25	16	0.8	WN**0604...	3
AWLNR/L2525M0604-A	25	25	150	27	25	32	23	0.8	WN**0604...	3

*Torque: Recommended torque (lbf-ft, N-m) for clamping ** r_e : Standard corner radius

SPARE PARTS

Designation	Clamp	Clamp screw	Spring	Spring pin	Shim	Shim screw	Wrench
AWLNR/L**-A	ACP3S-E	ACS-5W	BP-7	SP-2.5	ASW322	CSTB-3.5	T-15F

Reference pages

ACLNR/L-Eco: Inserts → **B052** -

AWLNR/L-Eco: Inserts → **B097** -

Lever lock type toolholder with 95° approach angle, for negative 80° rhombic inserts

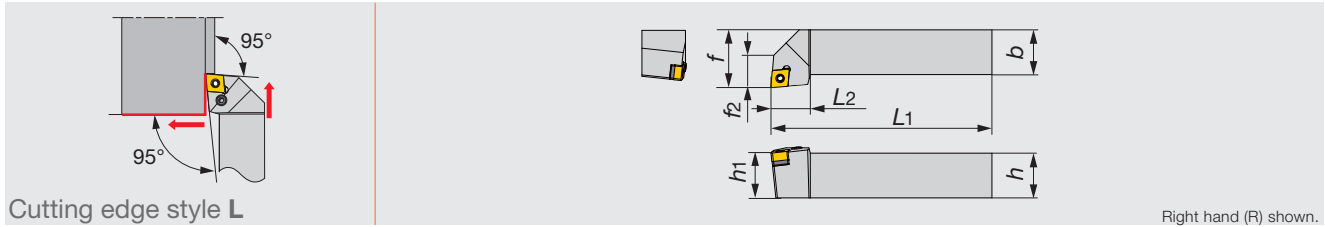

Inch	<i>h</i>	<i>b</i>	<i>L1</i>	<i>L2</i>	<i>h1</i>	<i>f</i>	<i>f2</i>	<i>r_e**</i>	Insert	Torque*
PCLNR/L1233	0.750	0.750	4.500	0.813	0.750	1.000	0.625	0.031	CN**33...	1.5
PCLNR/L1633	1.000	1.000	6.000	0.813	1.000	1.250	0.750	0.031	CN**33...	1.5

Metric	<i>h</i>	<i>b</i>	<i>L1</i>	<i>L2</i>	<i>h1</i>	<i>f</i>	<i>f2</i>	<i>r_e**</i>	Insert	Torque*
PCLNR/L2020K0904	20	20	125	20	20	25	15	0.8	CN**0904...	2
PCLNR/L2525M0904	25	25	150	25	25	32	18	0.8	CN**0904...	2

*Torque: Recommended torque (lbf-ft, N-m) for clamping ***r_e*: Standard corner radius

SPARE PARTS

Designation	Shim	Clamping screw	Wrench	Spring pin	Lever
PCLNR/L**	LSC317	LCS3	P-2.5	LSP3	LCL33

Lever lock type toolholder with 95° approach angle, for negative 80° rhombic inserts with channels for high pressure coolant

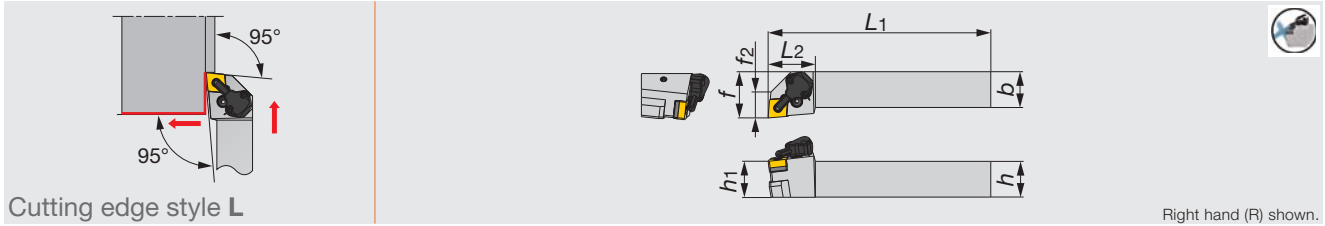

Inch	<i>h</i>	<i>b</i>	<i>L1</i>	<i>L2</i>	<i>h1</i>	<i>f</i>	<i>f2</i>	<i>r_e**</i>	Insert	Torque*
PCLNR/L1233-CHP	0.750	0.750	4.500	1.300	0.750	1.250	0.750	0.031	CN**33...	1.5
PCLNR/L1633-CHP	1.000	1.000	6.000	0.813	1.000	1.250	0.750	0.031	CN**33...	1.5

Metric	<i>h</i>	<i>b</i>	<i>L1</i>	<i>L2</i>	<i>h1</i>	<i>f</i>	<i>f2</i>	<i>r_e**</i>	Insert	Torque*
PCLNR/L2020K0904-CHP	20	20	125	33	20	32	18	0.8	CN**0904...	2
PCLNR/L2525M0904-CHP	25	25	150	33	25	32	18	0.8	CN**0904...	2

*Torque: Recommended torque (lbf-ft, N-m) for clamping ***r_e*: Standard corner radius

SPARE PARTS

Designation	Shim	Clamping screw	Wrench 1	Spring pin	Lever
PCLNR/L**-CHP	LSC317	LCS3	P-2.5	LSP3	LCL33

SPARE PARTS

Designation	Coolant unit	Mounting screw	Wrench 2	O-ring	Coolant screw	Wrench 3
PCLNR/L**-CHP	CU-CW-CHP	SRM3	T-8F	OR6.4X0.9N	SRM4X4TL360	P-2

Reference pages

PCLNR/L-Eco, PCLNR/L-CHP-Eco: Inserts → **B052 -**



ISO TURN

PWLNR/L-Eco

Lever lock type toolholder with 95° approach angle, for negative 80° trigon inserts

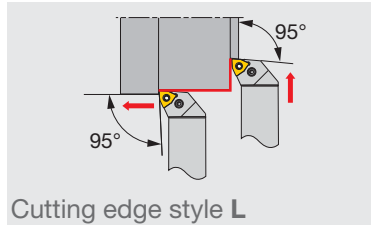

Cutting edge style L

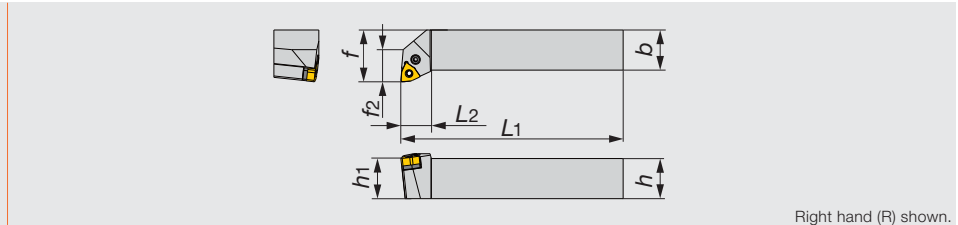

Right hand (R) shown.

Inch	<i>h</i>	<i>b</i>	<i>L</i> ₁	<i>L</i> ₂	<i>h</i> ₁	<i>f</i>	<i>f</i> ₂	<i>r</i> _c **	Insert	Torque*
PWLNR/L1233	0.750	0.750	4.500	0.625	0.750	1.000	0.688	0.031	WN**33...	1.5
PWLNR/L1633	1.000	1.000	6.000	0.719	1.000	1.250	0.750	0.031	WN**33...	1.5

Metric	<i>h</i>	<i>b</i>	<i>L</i> ₁	<i>L</i> ₂	<i>h</i> ₁	<i>f</i>	<i>f</i> ₂	<i>r</i> _c **	Insert	Torque*
PWLNR/L2020K0604	20	20	125	15	20	25	18	0.8	WN**0604...	2
PWLNR/L2525M0604	25	25	150	19	25	32	20	0.8	WN**0604...	2

*Torque: Recommended torque (lbf-ft, N-m) for clamping ***r*_c: Standard corner radius

SPARE PARTS

Designation	Shim	Clamping screw	Wrench	Spring pin	Lever
PWLNR/L....	LSW312	LCS3	P-2.5	LSP3	LCL3

ISO TURN

ADJNR/L-Eco

Double-clamp toolholder with 93° approach angle, for negative 55° rhombic inserts

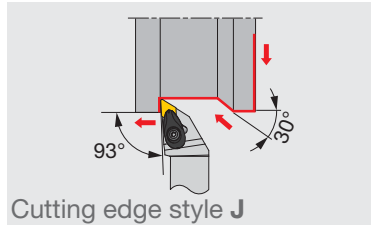

Cutting edge style J

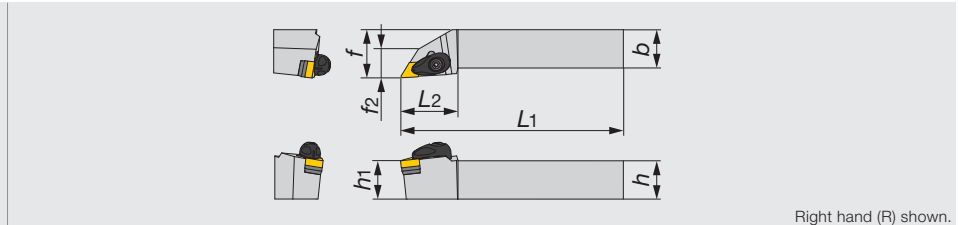

Right hand (R) shown.

Inch	<i>h</i>	<i>b</i>	<i>L</i> ₁	<i>L</i> ₂	<i>h</i> ₁	<i>f</i>	<i>f</i> ₂	<i>r</i> _c **	Insert	Torque*
ADJNR/L1233-A	0.750	0.750	4.500	1.250	0.750	1.000	0.625	0.031	DN**33...	2.2
ADJNR/L1633-A	1.000	1.000	6.000	1.250	1.000	1.250	0.900	0.031	DN**33...	2.2

Metric	<i>h</i>	<i>b</i>	<i>L</i> ₁	<i>L</i> ₂	<i>h</i> ₁	<i>f</i>	<i>f</i> ₂	<i>r</i> _c **	Insert	Torque*
ADJNR/L2020K1104-A	20	20	125	30	20	25	16	0.8	DN**1104...	3
ADJNR/L2525M1104-A	25	25	150	30	25	32	19	0.8	DN**1104...	3

*Torque: Recommended torque (lbf-ft, N-m) for clamping ***r*_c: Standard corner radius

SPARE PARTS

Designation	Clamp	Clamp screw	Spring	Spring pin	Shim	Shim screw	Wrench
ADJNR/L**-A	ACP3S-E	ACS-5W	BP-7	SP-2.5	ASD322	CSTB-3.5	T-15F

Reference pages

PWLNR/L-Eco: Inserts → **B097** -

ADJNR/L-Eco: Inserts → **B063** -

Lever lock type toolholder with 93° approach angle, for negative 55° rhombic inserts

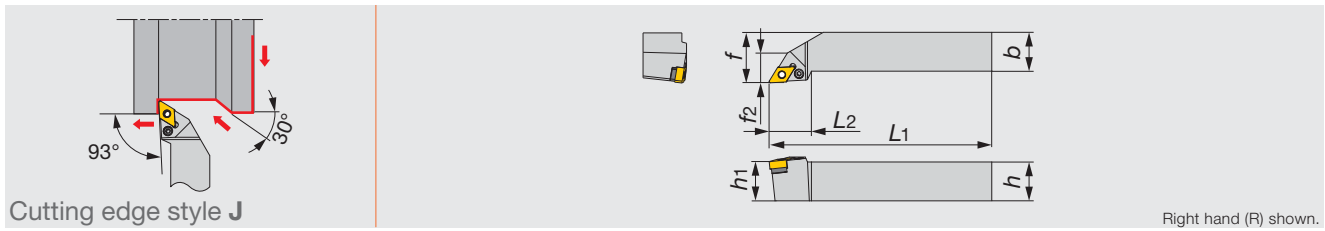

Inch	h	b	L1	L2	h1	f	f2	rε**	Insert	Torque*
PDJNR/L1033	0.625	0.625	4.000	1.125	0.625	0.875	0.625	0.031	DN**33...	1.5
PDJNR/L1233	0.750	0.750	4.500	1.125	0.750	1.000	0.625	0.031	DN**33...	1.5
PDJNR/L1633	1.000	1.000	6.000	1.125	1.000	1.250	0.750	0.031	DN**33...	1.5

Metric	h	b	L1	L2	h1	f	f2	rε**	Insert	Torque*
PDJNR/L1616H1104	16	16	100	27	16	20	16	0.8	DN**1104...	2
PDJNR/L2020K1104	20	20	125	27	20	25	16	0.8	DN**1104...	2
PDJNR/L2525M1104	25	25	150	27	25	32	19	0.8	DN**1104...	2

*Torque: Recommended torque (lbf-ft, N-m) for clamping **rε: Standard corner radius

SPARE PARTS

Designation	Shim	Clamping screw	Wrench	Spring pin	Lever
PDJNR/L...	ELSD32	LCS3	P-2.5	LSP3	LCL33L

ISO^{ECO}TURN TUNG^TJET

PDJNR/L-CHP-Eco

Lever lock type toolholder with 93° approach angle, for negative 55° rhombic inserts, with channels for high pressure coolant

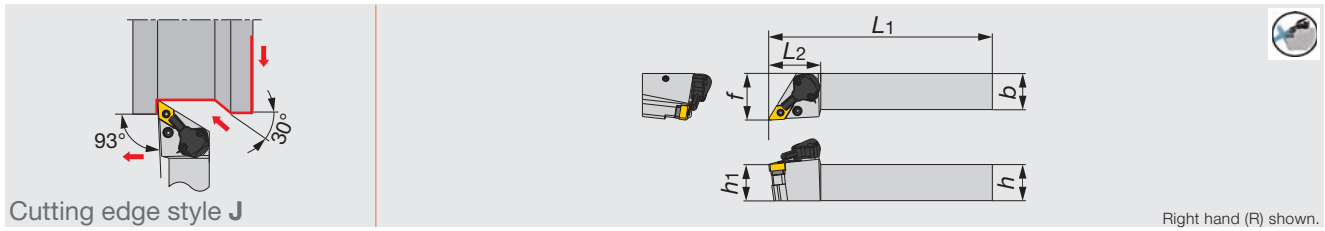

Inch	h	b	L1	L2	h1	f	rε**	Insert	Torque*
PDJNR/L1233-CHP	0.750	0.750	4.500	1.420	0.750	1.250	0.031	DN**33...	1.5
PDJNR/L1633-CHP	1.000	1.000	6.000	1.125	1.000	1.250	0.031	DN**33...	1.5

Metric	h	b	L1	L2	h1	f	rε**	Insert	Torque*
PDJNR/L2020K1104-CHP	20	20	125	36	20	32	0.8	DN**1104...	2
PDJNR/L2525M1104-CHP	25	25	150	36	25	32	0.8	DN**1104...	2

*Torque: Recommended torque (lbf-ft, N-m) for clamping **rε: Standard corner radius

SPARE PARTS

Designation	Shim	Clamping screw	Wrench 1	Spring pin	Lever
PDJNR/L**-CHP	ELSD32	LCS3	P-2.5	LSP3	LCL33L

SPARE PARTS

Designation	Coolant unit	Mounting screw	Wrench 2	O-ring	Coolant screw	Wrench 3
PDJNR/L**-CHP	CU-D-CHP	SRM3	T-8F	OR6.4X0.9N	SRM4X4TL360	P-2

Reference pages

PDJNR/L-Eco, PDJNR/L-CHP-Eco: Inserts → **B063** -



ISO ETURN

PTGNR/L-Eco

Lever lock type toolholder with 91° approach angle, for negative triangle inserts

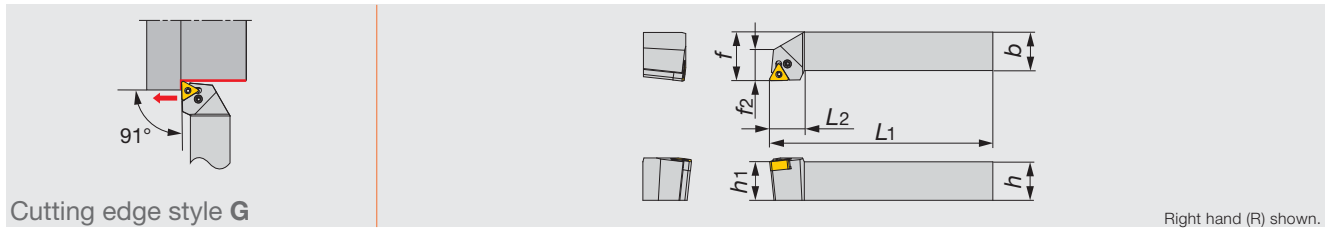

Inch	<i>h</i>	<i>b</i>	<i>L</i> ₁	<i>L</i> ₂	<i>h</i> ₁	<i>f</i>	<i>f</i> ₂	<i>r</i> _ε **	Insert	Torque*
PTGNR/L1223	0.750	0.750	4.500	0.750	0.750	1.000	0.625	0.031	TN**23...	1.5
PTGNR/L1623	1.000	1.000	6.000	0.750	1.000	1.250	0.875	0.031	TN**23...	1.5

Metric	<i>h</i>	<i>b</i>	<i>L</i> ₁	<i>L</i> ₂	<i>h</i> ₁	<i>f</i>	<i>f</i> ₂	<i>r</i> _ε **	Insert	Torque*
PTGNR/L2020K1104	20	20	125	20	20	25	15	0.8	TN**1104...	2
PTGNR/L2525M1104	25	25	150	20	25	32	22.5	0.8	TN**1104...	2

*Torque: Recommended torque (lbf-ft, N-m) for clamping ***r*_ε: Standard corner radius

SPARE PARTS

Designation	Clamping screw	Wrench	Lever
PTGNR/L...	LCS23A	P-2.5	LCL23

ISO ETURN

ADQNR/L-Eco

Double-clamp toolholder with 107.5° approach angle, for negative 55° rhombic inserts

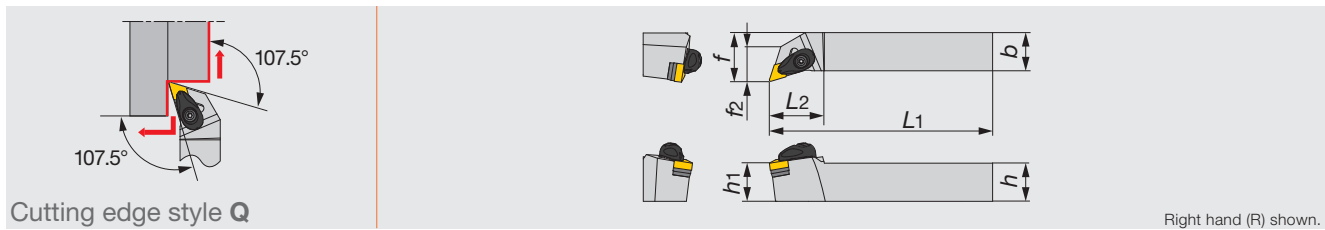

Inch	<i>h</i>	<i>b</i>	<i>L</i> ₁	<i>L</i> ₂	<i>h</i> ₁	<i>f</i>	<i>f</i> ₂	<i>r</i> _ε **	Insert	Torque*
ADQNR/L1233-A	0.750	0.750	4.500	1.150	0.750	1.000	0.750	0.031	DN**33...	2.2
ADQNR/L1633-A	1.000	1.000	6.000	1.150	1.000	1.250	0.800	0.031	DN**33...	2.2

Metric	<i>h</i>	<i>b</i>	<i>L</i> ₁	<i>L</i> ₂	<i>h</i> ₁	<i>f</i>	<i>f</i> ₂	<i>r</i> _ε **	Insert	Torque*
ADQNR/L2020K1104-A	20	20	125	30	20	25	18	0.8	DN**1104...	3
ADQNR/L2525M1104-A	25	25	150	30	25	32	20	0.8	DN**1104...	3

*Torque: Recommended torque (lbf-ft, N-m) for clamping ***r*_ε: Standard corner radius

SPARE PARTS

Designation	Clamp	Clamp screw	Spring	Spring pin	Shim	Shim screw	Wrench
ADQNR/L*-A	ACP3S-E	ACS-5W	BP-7	SP-2.5	ASD322	CSTB-3.5	T-15F

Reference pages

PTGNR/L-Eco: Inserts → **B082** -

ADQNR/L-Eco: Inserts → **B063** -

Double-clamp toolholders – 93° approach angle. For negative 35° rhombic insert.

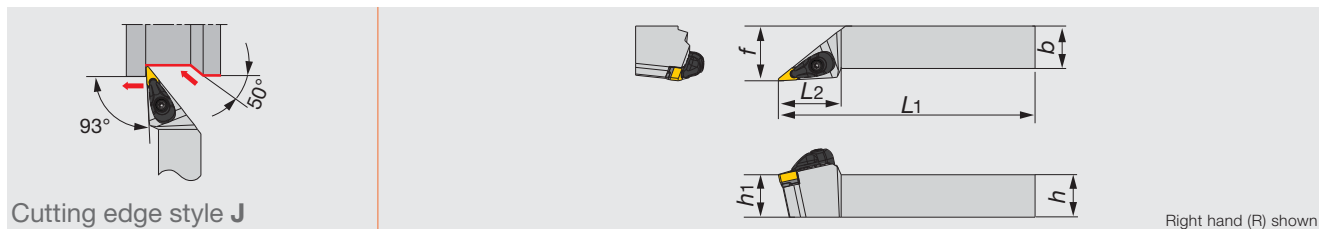

Cutting edge style J

Right hand (R) shown.

Inch	h	b	L1	L2	h1	f	r _e **	Insert	Torque*
AVJNR/L122.33-A	0.750	0.750	4.500	1.500	0.750	1.000	0.031	VN**2.33**E...	2.2
AVJNR/L162.33-A	1.000	1.000	6.000	1.500	1.000	1.250	0.031	VN**2.33**E...	2.2
Metric	h	b	L1	L2	h1	f	r _e **	Insert	Torque*
AVJNR/L2020K1204-A	20	20	125	37	20	25	0.8	VN**1204...	3
AVJNR/L2525M1204-A	25	25	150	37	25	32	0.8	VN**1204...	3

*Torque: Recommended torque (lbf-ft, N·m) for clamping **r_e: Standard corner radius

SPARE PARTS

Designation	Clamp	Clamp screw	Spring	Spring pin	Shim	Shim screw	Wrench
AVJNR/L**-A	ACP3L-E	ACS-5W	BP-7	SP-2.5	ASV222	CSTB-3.0	T-15F

Double-clamp toolholders – 117.5° approach angle. For negative 35° rhombic insert.

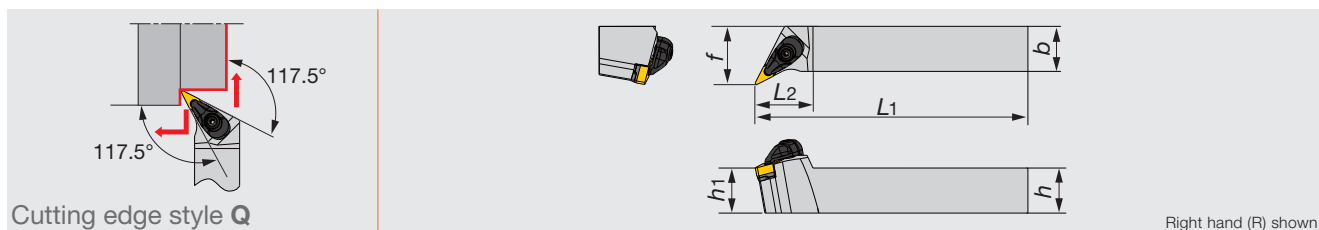

Cutting edge style Q

Right hand (R) shown.

Inch	h	b	L1	L2	h1	f	r _e **	Insert	Torque*
AVQNR/L122.33-A	0.750	0.750	4.500	1.250	0.750	1.000	0.031	VN**2.33**E...	2.2
AVQNR/L162.33-A	1.000	1.000	6.000	1.250	1.000	1.250	0.031	VN**2.33**E...	2.2
Metric	h	b	L1	L2	h1	f	r _e **	Insert	Torque*
AVQNR/L2020K1204-A	20	20	125	32	20	25	0.8	VN**1204...	3
AVQNR/L2525M1204-A	25	25	150	32	25	32	0.8	VN**1204...	3

*Torque: Recommended torque (lbf-ft, N·m) for clamping **r_e: Standard corner radius

SPARE PARTS

Designation	Clamp	Clamp screw	Spring	Spring pin	Shim	Shim screw	Wrench
AVQNR/L**-A	ACP3L-E	ACS-5W	BP-7	SP-2.5	ASV222	CSTB-3.0	T-15F

Reference pages

AVJNR/L-Eco, AVQNR/L-Eco: Inserts → **B093** -



ISO TURN

AVVNN-Eco

Double-clamp toolholders – 72.5° approach angle. For negative 35° rhombic insert.

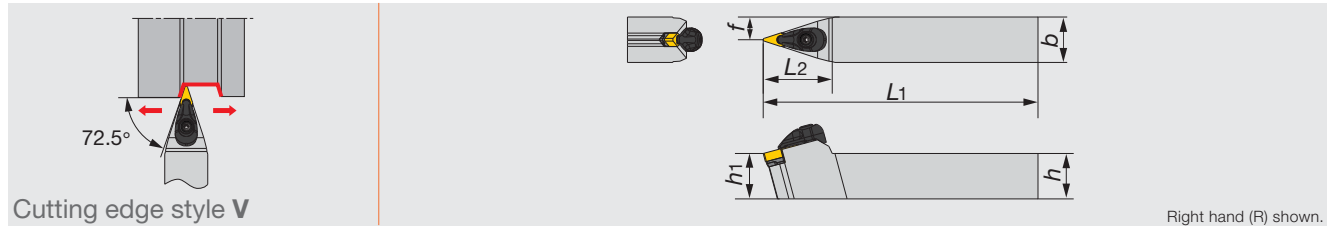

Inch	<i>h</i>	<i>b</i>	<i>L</i> ₁	<i>L</i> ₂	<i>h</i> ₁	<i>f</i>	<i>r</i> _c **	Insert	Torque*
AVVNN122.33-A	0.750	0.750	4.500	1.500	0.750	0.375	0.031	VN**2.33**E...	2.2
AVVNN162.33-A	1.000	1.000	6.000	1.500	1.000	0.500	0.031	VN**2.33**E...	2.2

Metric	<i>h</i>	<i>b</i>	<i>L</i> ₁	<i>L</i> ₂	<i>h</i> ₁	<i>f</i>	<i>r</i> _c **	Insert	Torque*
AVVNN2020K1204-A	20	20	125	38	20	10	0.8	VN**1204...	3
AVVNN2525K1204-A	25	25	150	38	25	13	0.8	VN**1204...	3

*Torque: Recommended torque (lbf-ft, N-m) for clamping ***r*_c: Standard corner radius

SPARE PARTS

Designation	Clamp	Clamp screw	Spring	Spring pin	Shim	Shim screw	Wrench
AVVNN**A	ACP3L-E	ACS-5W	BP-7	SP-2.5	ASV222	CSTB-3.0	T-15F

TURNING

ACLNR/L

Double-clamp toolholder with 95° approach angle, for negative 80° rhombic inserts

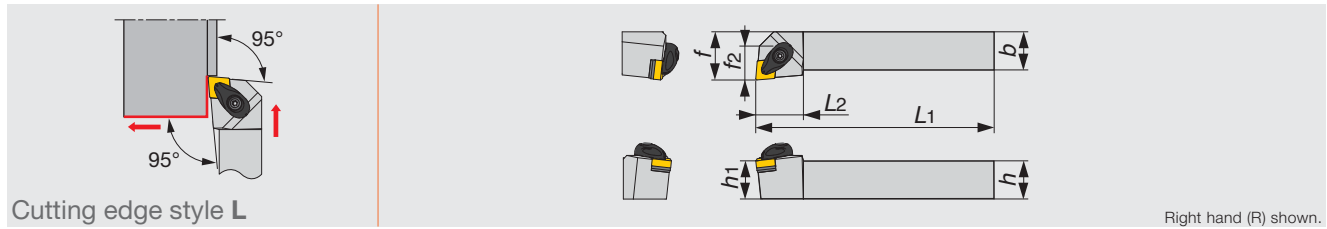

Inch	<i>h</i>	<i>b</i>	<i>L</i> ₁	<i>L</i> ₂	<i>h</i> ₁	<i>f</i>	<i>f</i> ₂	<i>r</i> _c **	Insert	Torque*
ACLNR/L1233-A	0.750	0.750	4.500	0.900	0.750	1.000	0.625	0.031	CN**33...	2.2
ACLNR/L1633-A	1.000	1.000	6.000	1.000	1.000	1.250	0.750	0.031	CN**33...	2.2
ACLNR/L124-A	0.750	0.750	4.500	1.000	0.750	1.000	0.750	0.031	CN**43...	2.2
ACLNR/L164-A	1.000	1.000	6.000	1.250	1.000	1.250	0.875	0.031	CN**43...	2.2
ACLNR/L205-A	1.250	1.250	7.000	1.500	1.250	1.500	1.000	0.047	CN**54...	4.7
ACLNR/L245-A	1.500	1.500	8.000	1.500	1.500	1.750	1.125	0.047	CN**54...	4.7
ACLNR/L206-A	1.250	1.250	7.000	1.500	1.250	1.500	1.000	0.047	CN**64...	4.7
ACLNR/L246-A	1.500	1.500	8.000	1.500	1.500	1.750	1.125	0.047	CN**64...	4.7

Metric	<i>h</i>	<i>b</i>	<i>L</i> ₁	<i>L</i> ₂	<i>h</i> ₁	<i>f</i>	<i>f</i> ₂	<i>r</i> _c **	Insert	Torque*
ACLNR/L2020K12-A	20	20	125	26	20	25	19	0.8	CN**1204...	3
ACLNR/L2525M12-A	25	25	150	30	25	32	21	0.8	CN**1204...	3
ACLNR/L3225P12-A	32	25	170	30	32	32	21	0.8	CN**1204...	3
ACLNR/L2525M16-A	25	25	150	31	25	32	22	1.2	CN**1606...	6.4
ACLNR/L3225P16-A	32	25	170	31	32	32	22	1.2	CN**1606...	6.4
ACLNR/L3232P16-A	32	32	170	31	32	40	22	1.2	CN**1606...	6.4
ACLNR/L3232P19-A	32	32	170	40	32	40	25	1.2	CN**1906...	6.4
ACLNR/L4040S19-A	40	40	250	40	40	50	25	1.2	CN**1906...	6.4

*Torque: Recommended torque (lbf-ft, N-m) for clamping

***r*_c: Standard corner radius

SPARE PARTS

Designation	Clamp	Clamp screw	Spring	Spring pin	Shim	Shim screw	Wrench 1	Wrench 2
ACLNR/L**33-A	ACP3S-E	ACS-5W	BP-7	SP-2.5	ASC322	CSTB-3.5	T-15F	-
ACLNR/L**4-A, ACLNR/L**12-A	ACP4S	ACS-5W	BP-7	SP-2.5	ASC422	CSTB-3.5	T-15F	-
ACLNR/L**5-A, ACLNR/L**16-A	ACP5S	ACS-6W	BP-8.8	SP-2.5	ASC533	CSTB-5	-	KEYV-T20
ACLNR/L**6-A, ACLNR/L**19-A	ACP6S	ACS-6W	BP-8.8	SP-2.5	ASC634	CSTB-5	-	KEYV-T20

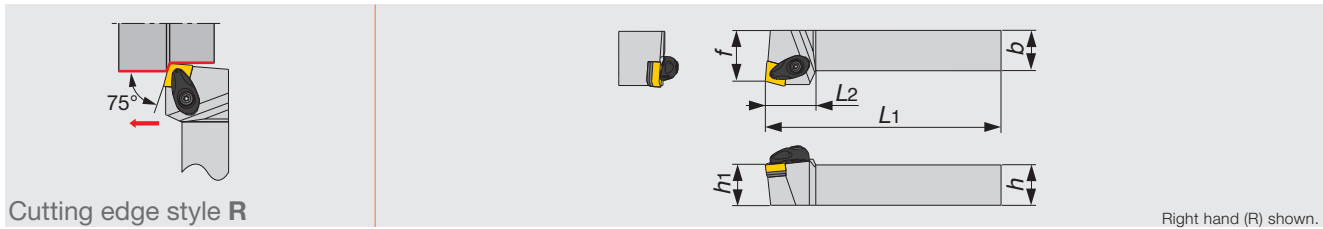

Inch	<i>h</i>	<i>b</i>	<i>L</i> ₁	<i>L</i> ₂	<i>h</i> ₁	<i>f</i>	<i>r</i> _ε **	Insert	Torque*
ACRNR/L164-A	1.000	1.000	6.000	1.25	1.000	1.25	0.032	CN**43...	2.2

*Torque: Recommended torque (lbf-ft, N-m) for clamping
 ***r*_ε: Standard corner radius

SPARE PARTS

Designation	Clamp	Clamp screw	Spring	Spring pin	Shim	Shim screw	Wrench 1
ACRNR/L164-A	ACP4S	ACS-5W	BP-7	SP-2.5	ASC422	CSTB-3.5	T-15F

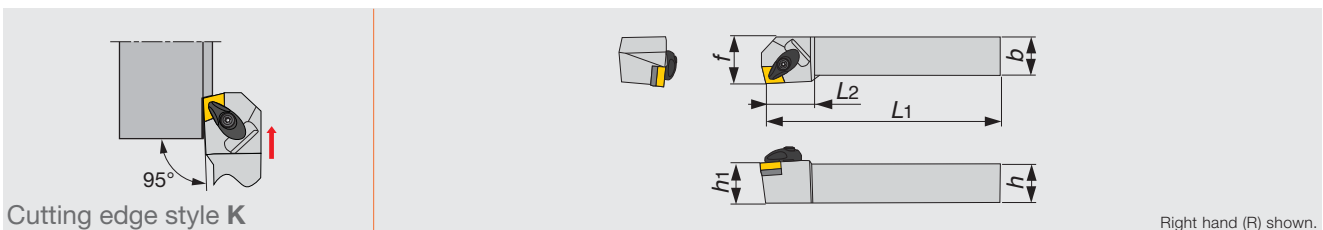

Inch	<i>h</i>	<i>b</i>	<i>L</i> ₁	<i>L</i> ₂	<i>h</i> ₁	<i>f</i>	<i>f</i> ₂	<i>r</i> _ε **	Insert	Torque*
ACKNR/L164-A	1.000	1.000	6.000	1.375	1.000	1.312	0.875	0.032	CN**43...	2.2

*Torque: Recommended torque (lbf-ft, N-m) for clamping
 ***r*_ε: Standard corner radius

SPARE PARTS

Designation	Clamp	Clamp screw	Spring	Spring pin	Shim	Shim screw	Wrench 1
ACKNR/L164-A	ACP4S	ACS-5W	BP-7	SP-2.5	ASC422	CSTB-3.5	T-15F

Reference pages

AVVNN-Eco: Inserts → **B093 -**

ACLNR/L, ACRNR/L, ACKNR/L: Inserts → **B052 -**, CBN → **B165 -**, PCD → **B178**



TURNINGA

AWLNR/L

Double-clamp toolholder with 95° approach angle, for negative trigon inserts

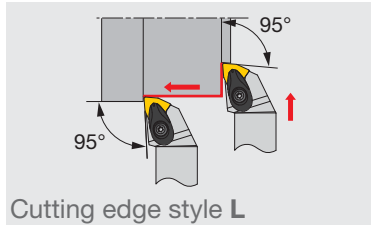

Cutting edge style L

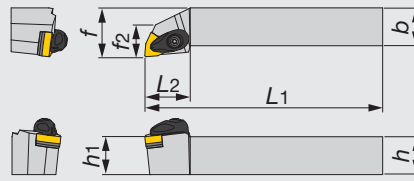

Right hand (R) shown.

Inch	h	b	L1	L2	h1	f	f2	re**	Insert	Torque*
AWLNR/L1233-A	0.750	0.750	4.500	1.125	0.750	1.000	0.625	0.031	WN**33...	2.2
AWLNR/L123-A	0.750	0.750	4.500	1.125	0.750	1.000	0.625	0.031	WN**33...	2.2
AWLNR/L1633-A	1.000	1.000	6.000	1.125	1.000	1.250	0.875	0.031	WN**33...	2.2
AWLNR/L163-A	1.000	1.000	6.000	1.125	1.000	1.250	0.875	0.031	WN**33...	2.2
AWLNR/L124-A	0.750	0.750	4.500	1.250	0.750	1.000	0.764	0.031	WN**43...	2.2
AWLNR/L164-A	1.000	1.000	6.000	1.250	1.000	1.250	0.875	0.031	WN**43...	2.2
AWLNR/L204-A	1.250	1.250	7.000	1.250	1.250	1.500	1.000	0.031	WN**43...	2.2

Metric	h	b	L1	L2	h1	f	f2	re**	Insert	Torque*
AWLNR/L2020K06-A	20	20	125	27	20	25	16	0.8	WN**0604...	3
AWLNR/L2020K08-A	20	20	125	30	20	25	19	0.8	WN**0804...	3
AWLNR/L2525M06-A	25	25	150	27	25	32	23	0.8	WN**0604...	3
AWLNR/L2525M08-A	25	25	150	30	25	32	21	0.8	WN**0804...	3
AWLNR/L3225P08-A	32	25	170	30	32	32	21	0.8	WN**0804...	3

*Torque: Recommended torque (lbf-ft, N-m) for clamping

**re: Standard corner radius

SPARE PARTS

Designation	Clamp	Clamp screw	Spring	Spring pin	Shim	Shim screw	Wrench
AWLNR/L**3-A, 06-A	ACP3S	ACS-5W	BP-7	SP-2.5	ASW322	CSTB-3.5	T-15F
AWLNR/L**4-A, 08-A	ACP4S	ACS-5W	BP-7	SP-2.5	ASW422	CSTB-3.5	T-15F

TURNINGA

ADJNR/L

Double-clamp toolholder with 93° approach angle, for negative 55° rhombic inserts

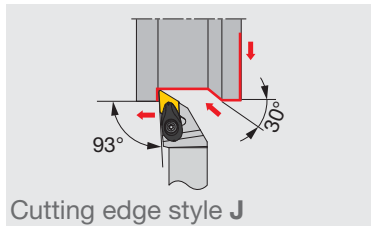

Cutting edge style J

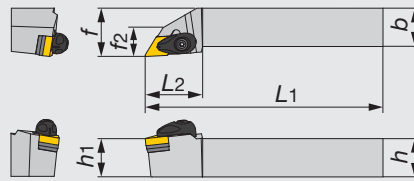

Right hand (R) shown.

Inch	h	b	L1	L2	h1	f	f2	re**	Insert	Torque*
ADJNR/L1233-A	0.750	0.750	4.500	1.250	0.750	1.000	0.625	0.031	DN**33...	2.2
ADJNR/L124-A	0.750	0.750	4.500	1.500	0.750	1.000	0.750	0.031	DN**43...	2.2
ADJNR/L1633-A	1.000	1.000	6.000	1.250	1.000	1.250	0.900	0.031	DN**33...	2.2
ADJNR/L164-A	1.000	1.000	6.000	1.500	1.000	1.250	0.750	0.031	DN**43...	2.2
ADJNR/L204-A	1.250	1.250	7.000	1.500	1.250	1.500	1.000	0.031	DN**43...	2.2

Metric	h	b	L1	L2	h1	f	f2	re**	Insert	Torque*
ADJNR/L2020K15-A	20	20	125	36	20	25	17	0.8	DN**1504...	3
ADJNR/L2020K1506-A	20	20	125	36	20	25	17	0.8	DN**1506...	3
ADJNR/L2525M15-A	25	25	150	36	25	32	18	0.8	DN**1504...	3
ADJNR/L2525M1506-A	25	25	150	36	25	32	18	0.8	DN**1506...	3
ADJNR/L3225P15-A	32	25	170	36	32	32	18	0.8	DN**1504...	3

*Torque: Recommended torque (lbf-ft, N-m) for clamping

**re: Standard corner radius

SPARE PARTS

Designation	Clamp	Clamp screw	Spring	Spring pin	Shim	Shim screw	Wrench
ADJNR/L**3-A, 15-A	ACP4S	ACS-5W	BP-7	SP-2.5	ASD432	CSTB-3.5	T-15F
ADJNR/L**4-A, 1506-A	ACP4S	ACS-5W	BP-7	SP-2.5	ASD423	CSTB-3.5	T-15F

Double-clamp toolholder with 93° approach angle, for negative 35° and 25° rhombic inserts

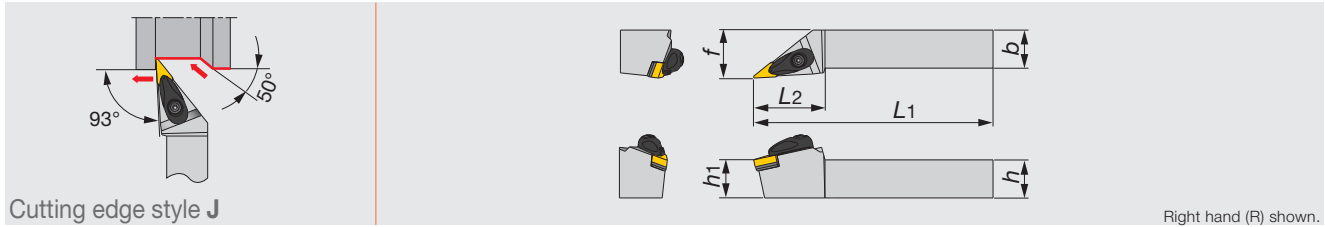

Inch	<i>h</i>	<i>b</i>	<i>L1</i>	<i>L2</i>	<i>h1</i>	<i>f</i>	<i>re**</i>	Insert	Torque*
AVJNR/L123-A	0.750	0.750	4.500	1.750	0.750	1.000	0.031	V/YN**33...	2.2
AVJNR/L163-A	1.000	1.000	6.000	1.870	1.000	1.250	0.031	V/YN**33...	2.2

Metric	<i>h</i>	<i>b</i>	<i>L1</i>	<i>L2</i>	<i>h1</i>	<i>f</i>	<i>re**</i>	Insert	Torque*
AVJNR/L2020K16-A	20	20	125	43	20	25	0.8	V/YN**1604...	3
AVJNR/L2525M16-A	25	25	150	46	25	32	0.8	V/YN**1604...	3

*Torque: Recommended torque (lbf-ft, N-m) for clamping
 ***re*: Standard corner radius

SPARE PARTS							
Designation	Clamp	Clamp screw	Spring	Spring pin	Shim	Shim screw	Wrench
AVJNR/L**3-A, 16-A	ACP3L	ACS-5W	BP-7	SP-2.5	ASV322	CSTB-3.5	T-15F

Double-clamp toolholder with 93° approach angle, for negative triangle inserts

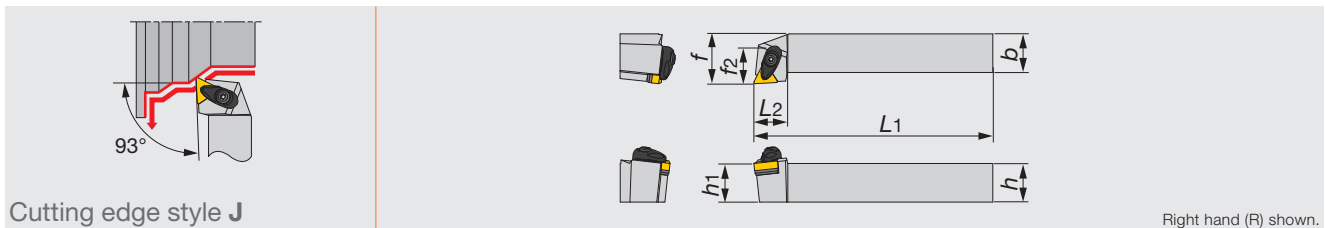

Inch	<i>h</i>	<i>b</i>	<i>L1</i>	<i>L2</i>	<i>h1</i>	<i>f</i>	<i>f2</i>	<i>re**</i>	Insert	Torque*
ATJNR/L123-A	0.750	0.750	4.500	0.875	0.750	1.000	0.875	0.031	TN**33...	2.2
ATJNR/L163-A	1.000	1.000	6.000	0.875	1.000	1.250	1.000	0.031	TN**33...	2.2

Metric	<i>h</i>	<i>b</i>	<i>L1</i>	<i>L2</i>	<i>h1</i>	<i>f</i>	<i>f2</i>	<i>re**</i>	Insert	Torque*
ATJNR/L2020K16-A	20	20	125	22	20	25	23	0.8	TN**1604...	3
ATJNR/L2525M16-A	25	25	150	22	25	32	25	0.8	TN**1604...	3

*Torque: Recommended torque (lbf-ft, N-m) for clamping
 ***re*: Standard corner radius

SPARE PARTS							
Designation	Clamp	Clamp screw	Spring	Spring pin	Shim	Shim screw	Wrench
ATJNR/L**3-A, 16-A	ACP3S	ACS-5W	BP-7	SP-2.5	AST322	CSTB-3.5	T-15F

Reference pages

- AWLNR/L: Inserts → B097 -, CBN → B167
- ADJNR/L: Inserts → B063 -, CBN → B165 -, PCD → B178
- AVJNR/L: Inserts → B093 -, B104, CBN → B167, PCD → B178
- ATJNR/L: Inserts → B082 -, CBN → B166, PCD → B178



TURNINGA

AVVNN

Double-clamp toolholder with 72.5° approach angle, for negative 35° and 25° rhombic inserts

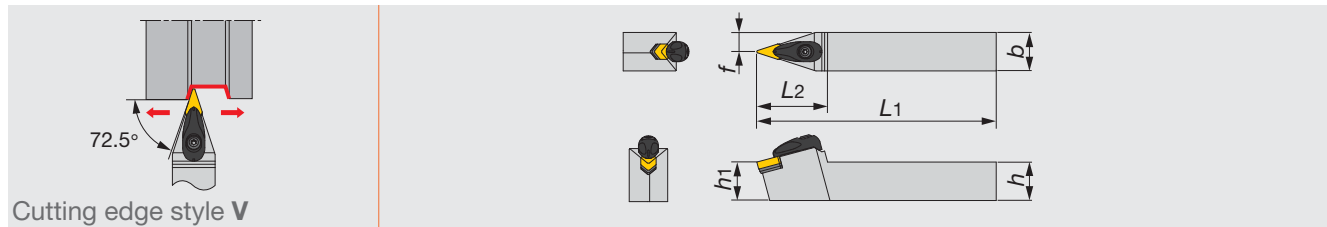

Cutting edge style V

Inch	<i>h</i>	<i>b</i>	<i>L</i> ₁	<i>L</i> ₂	<i>h</i> ₁	<i>f</i>	<i>r_e</i> **	Insert	Torque*
AVVNN123-A	0.750	0.750	4.500	1.870	0.750	0.375	0.031	V/YN**33...	2.2
AVVNN163-A	1.000	1.000	6.000	1.870	1.000	0.500	0.031	V/YN**33...	2.2
Metric	<i>h</i>	<i>b</i>	<i>L</i> ₁	<i>L</i> ₂	<i>h</i> ₁	<i>f</i>	<i>r_e</i> **	Insert	Torque*
AVVNN2020K16-A	20	20	125	46	20	10	0.8	V/YN**1604...	3
AVVNN2525M16-A	25	25	150	46	25	12.5	0.8	V/YN**1604...	3

*Torque: Recommended torque (lbf-ft, N-m) for clamping

***r_e*: Standard corner radius

SPARE PARTS							
Designation	Clamp	Clamp screw	Spring	Spring pin	Shim	Shim screw	Wrench
AVVNN**3-A, 16-A	ACP3L	ACS-5W	BP-7	SP-2.5	ASV322	CSTB-3.5	T-15F

TURNINGA

ADPNN

Double-clamp toolholder with 62.5° approach angle, for negative 55° rhombic inserts

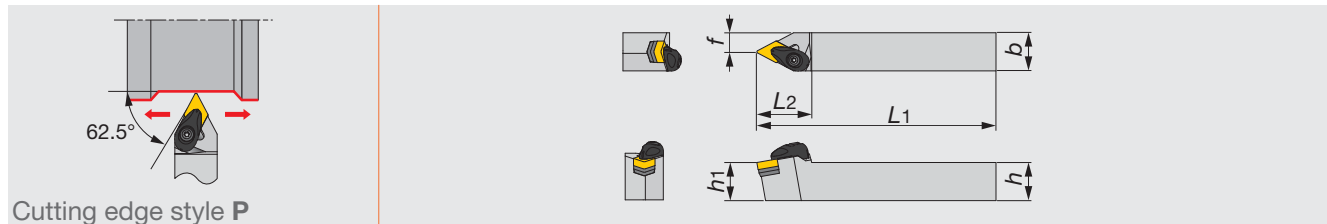

Cutting edge style P

Inch	<i>h</i>	<i>b</i>	<i>L</i> ₁	<i>L</i> ₂	<i>h</i> ₁	<i>f</i>	<i>r_e</i> **	Insert	Torque*
ADPNN124-A	0.750	0.750	4.500	1.500	0.750	0.375	0.031	DN**43...	2.2
ADPNN164-A	1.000	1.000	6.000	1.500	1.000	0.500	0.031	DN**43...	2.2
Metric	<i>h</i>	<i>b</i>	<i>L</i> ₁	<i>L</i> ₂	<i>h</i> ₁	<i>f</i>	<i>r_e</i> **	Insert	Torque*
ADPNN2020K15-A	20	20	125	36	20	7.5	0.8	DN**1504...	3
ADPNN2525M15-A	25	25	150	36	25	12.5	0.8	DN**1504...	3

*Torque: Recommended torque (lbf-ft, N-m) for clamping

***r_e*: Standard corner radius

SPARE PARTS							
Designation	Clamp	Clamp screw	Spring	Spring pin	Shim	Shim screw	Wrench
ADPNN**4-A, 15-A	ACP4S	ACS-5W	BP-7	SP-2.5	ASD432	CSTB-3.5	T-15F

Reference pages

AVVNN: Inserts → B093 -, B104, CBN → B167 -, PCD → B178

ADPNN: Inserts → B063 -, CBN → B165 -, PCD → B178

ATGNR/L: Inserts → B082 -, CBN → B166 -, PCD → B178

ASBNR/L: Inserts → B073 -, CBN → B166 -, PCD → B178

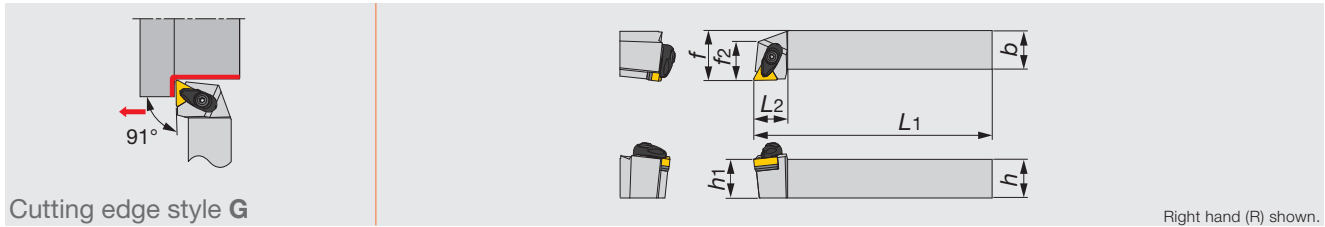

Inch	h	b	L1	L2	h1	f	f2	re**	Insert	Torque*
ATGNR/L123-A	0.750	0.750	4.500	0.875	0.750	1.000	0.875	0.031	TN**33...	2.2
ATGNR/L163-A	1.000	1.000	6.000	0.875	1.000	1.250	1.000	0.031	TN**33...	2.2
ATGNR/L164-A	1.000	1.000	6.000	1.000	1.000	1.250	1.000	0.031	TN**43...	2.2

Metric	h	b	L1	L2	h1	f	f2	re**	Insert	Torque*
ATGNR/L2020K16-A	20	20	125	22	20	25	22	0.8	TN**1604...	3
ATGNR/L2525M16-A	25	25	150	22	25	32	25	0.8	TN**1604...	3
ATGNR/L2525M22-A	25	25	150	26	25	32	26	0.8	TN**2204...	3

*Torque: Recommended torque (lbf-ft, N-m) for clamping
 **re: Standard corner radius

SPARE PARTS	Clamp	Clamp screw	Spring	Spring pin	Shim	Shim screw	Wrench
Designation	ACP3S	ACS-5W	BP-7	SP-2.5	AST322	CSTB-3.5	T-15F
ATGNR/L**3-A, 16-A	ACP3S	ACS-5W	BP-7	SP-2.5	AST322	CSTB-3.5	T-15F
ATGNR/L**4-A, 22-A	ACP4S	ACS-5W	BP-7	SP-2.5	AST422	CSTB-3.5	T-15F

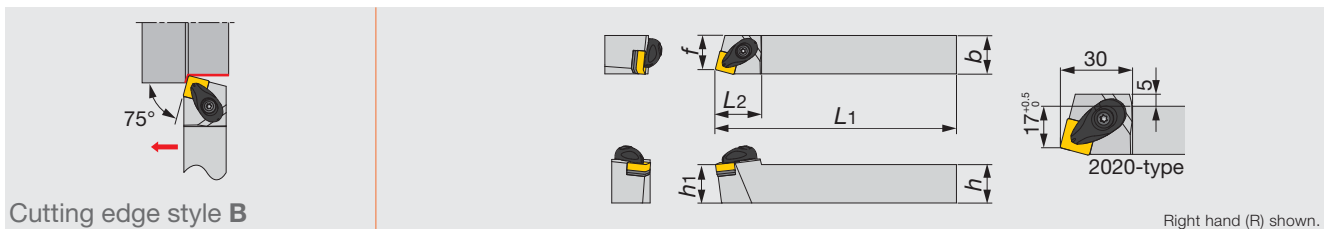

Inch	h	b	L1	L2	h1	f	re**	Insert	Torque*
ASBNR/L124-A	0.750	0.750	4.500	1.180	0.750	0.625	0.031	SN**43...	2.2
ASBNR/L164-A	1.000	1.000	6.000	1.180	1.000	0.875	0.031	SN**43...	2.2
ASBNR/L205-A	1.250	1.250	7.000	1.500	1.250	1.100	0.031	SN**54...	4.7
ASBNR/L245-A	1.500	1.500	8.000	1.500	1.500	1.350	0.031	SN**54...	4.7
ASBNR/L206-A	1.250	1.250	7.000	1.625	1.250	1.100	0.031	SN**64...	4.7
ASBNR/L246-A	1.500	1.500	8.000	1.625	1.500	1.350	0.031	SN**64...	4.7

Metric	h	b	L1	L2	h1	f	re**	Insert	Torque*
ASBNR/L2020K12-A	20	20	125	30	20	17	0.8	SN**1204...	3
ASBNR/L2525M12-A	25	25	150	30	25	22	0.8	SN**1204...	3
ASBNR/L2525M15-A	25	25	150	42.5	25	22	1.2	SN**1506...	6.4
ASBNR/L3232P15-A	32	32	170	42.5	32	27	1.2	SN**1506...	6.4
ASBNR/L3232P19-A	32	32	170	47.5	32	27	1.2	SN**1906...	6.4
ASBNR/L4040S19-A	40	40	250	47.5	40	35	1.2	SN**1906...	6.4

*Torque: Recommended torque (lbf-ft, N-m) for clamping
 **re: Standard corner radius

SPARE PARTS	Clamp	Clamp screw	Spring	Spring pin	Shim	Shim screw	Wrench 1	Wrench 2
Designation	ACP4S	ACS-5W	BP-7	SP-2.5	ASS422	CSTB-3.5	T-15F	-
ASBNR/L**4-A, 12-A	ACP4S	ACS-5W	BP-7	SP-2.5	ASS422	CSTB-3.5	T-15F	-
ASBNR/L**5-A, 15-A	ACP5S	ACS-6W	BP-8.8	SP-2.5	ASS533	CSTB-5	-	KEYV-T20
ASBNR/L**6-A, 19-A	ACP6S	ACS-6W	BP-8.8	SP-2.5	ASS634	CSTB-5	-	KEYV-T20



TURNING A

ASDNN

Double-clamp toolholder with 45° approach angle, for negative square inserts

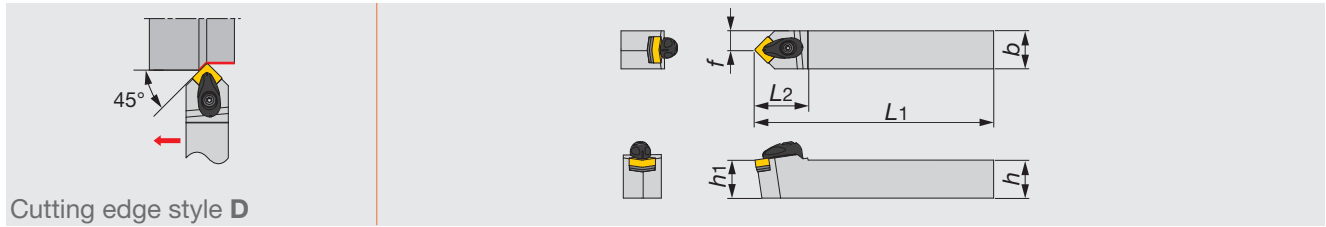

Cutting edge style D

Inch	h	b	L1	L2	h1	f	r _ε **	Insert	Torque*
ASDNN124-A	0.750	0.750	4.500	1.380	0.750	0.375	0.031	SN**43...	2.2
ASDNN164-A	1.000	1.000	6.000	1.380	1.000	0.500	0.031	SN**43...	2.2

Metric	h	b	L1	L2	h1	f	r _ε **	Insert	Torque*
ASDNN2020K12-A	20	20	125	35	20	10	0.8	SN**1204...	3
ASDNN2525M12-A	25	25	150	35	25	12.5	0.8	SN**1204...	3

*Torque: Recommended torque (lbf-ft, N-m) for clamping

**r_ε: Standard corner radius

SPARE PARTS

Designation	Clamp	Clamp screw	Spring	Spring pin	Shim	Shim screw	Wrench
ASDNN**4-A, 12-A	ACP4S	ACS-5W	BP-7	SP-2.5	ASS422	CSTB-3.5	T-15F

TURNING A

ASSNR/L

Double-clamp toolholder with 45° approach angle (S-style), for negative square inserts

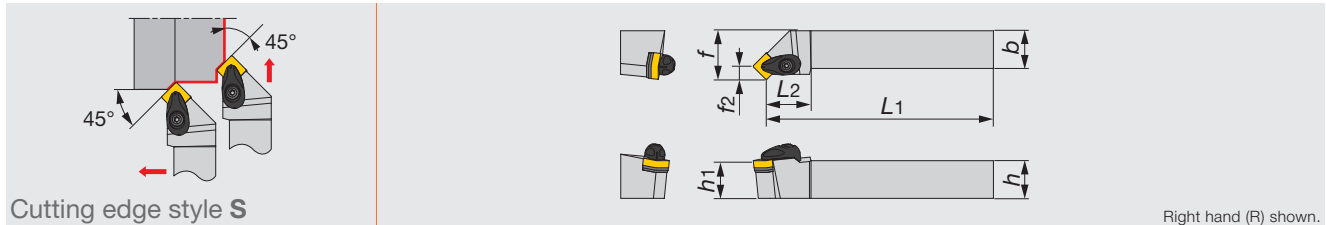

Cutting edge style S

Right hand (R) shown.

Inch	h	b	L1	L2	h1	f	f2	r _ε **	Insert	Torque*
ASSNR/L124-A	0.750	0.750	4.500	1.250	0.750	1.000	0.327	0.031	SN**43...	2.2
ASSNR/L164-A	1.000	1.000	6.000	1.250	1.000	1.250	0.327	0.031	SN**43...	2.2
ASSNR/L205-A	1.250	1.250	7.000	1.500	1.250	1.500	-	0.031	SN**54...	4.7
ASSNR/L245-A	1.500	1.500	8.000	1.500	1.500	1.750	-	0.031	SN**54...	4.7
ASSNR/L206-A	1.250	1.250	7.000	1.500	1.250	1.500	-	0.031	SN**64...	4.7
ASSNR/L246-A	1.500	1.500	8.000	1.500	1.500	1.750	-	0.031	SN**64...	4.7

Metric	h	b	L1	L2	h1	f	f2	r _ε **	Insert	Torque*
ASSNR/L2020K12-A	20	20	125	30	20	25	8.3	0.8	SN**1204...	3
ASSNR/L2525M12-A	25	25	150	30	25	32	8.3	0.8	SN**1204...	3
ASSNR/L2525M15-A	25	25	150	25	25	32	10.3	1.2	SN**1506...	6.4
ASSNR/L3232P15-A	32	32	170	25	32	40	10.3	1.2	SN**1506...	6.4
ASSNR/L3232P19-A	32	32	170	27.5	32	40	12.5	1.2	SN**1906...	6.4
ASSNR/L4040S19-A	40	40	250	27.5	40	50	12.5	1.2	SN**1906...	6.4

*Torque: Recommended torque (lbf-ft, N-m) for clamping

**r_ε: Standard corner radius

SPARE PARTS

Designation	Clamp	Clamp screw	Spring	Spring pin	Shim	Shim screw	Wrench 1	Wrench 2
ASSNR/L**4-A, 12-A	ACP4S	ACS-5W	BP-7	SP-2.5	ASS422	CSTB-3.5	T-15F	-
ASSNR/L**5-A, 15-A	ACP5S	ACS-6W	BP-8.8	SP-2.5	ASS533	CSTB-5	-	KEYV-T20
ASSNR/L**6-A, 19-A	ACP6S	ACS-6W	BP-8.8	SP-2.5	ASS634	CSTB-5	-	KEYV-T20

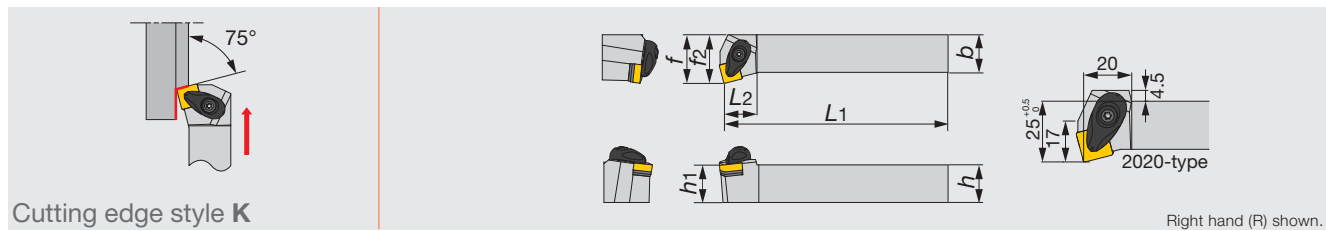

Inch	h	b	L1	L2	h1	f	f2	rε**	Insert	Torque*
ASKNR/L124-A	0.750	0.750	4.500	0.875	0.750	1.000	0.750	0.031	SN**43...	2.2
ASKNR/L164-A	1.000	1.000	6.000	1.000	1.000	1.250	0.875	0.031	SN**43...	2.2
Metric	h	b	L1	L2	h1	f	f2	rε**	Insert	Torque*
ASKNR/L2020K12-A	20	20	125	20	20	25	17	0.8	SN**1204...	3
ASKNR/L2525M12-A	25	25	150	22	25	32	21	0.8	SN**1204...	3

*Torque: Recommended torque (lbf-ft, N-m) for clamping
 **re: Standard corner radius

SPARE PARTS

Designation	Clamp	Clamp screw	Spring	Spring pin	Shim	Shim screw	Wrench
ASKNR/L*4-A, 12-A	ACP4S	ACS-5W	BP-7	SP-2.5	ASS422	CSTB-3.5	T-15F

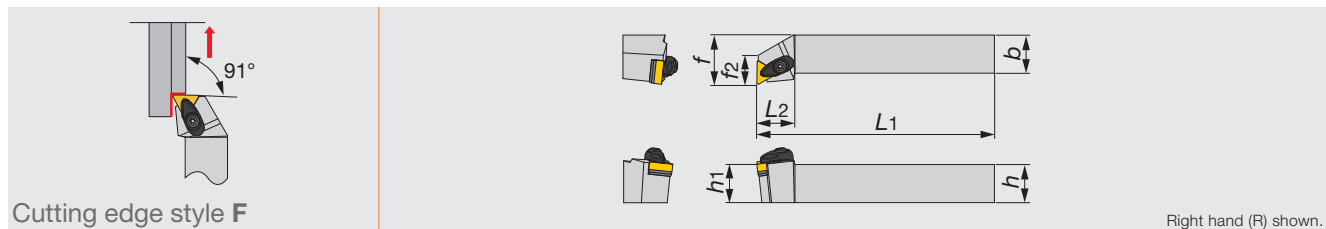

Inch	h	b	L1	L2	h1	f	f2	rε**	Insert	Torque*
ATFNR/L123-A	0.750	0.750	4.500	1.000	0.750	1.000	0.718	0.032	TN**33...	2.2
ATFNR/L163-A	1.000	1.000	6.000	1.000	1.000	1.250	0.750	0.032	TN**33...	2.2
Metric	h	b	L1	L2	h1	f	f2	rε**	Insert	Torque*
ATFNR/L2020K16-A	20	20	125	25	20	25	18	0.8	TN**1604...	3
ATFNR/L2525M16-A	25	25	150	25	25	32	19	0.8	TN**1604...	3
ATFNR/L2525M22-A	25	25	150	29	25	32	23	0.8	TN**2204...	3

*Torque: Recommended torque (lbf-ft, N-m) for clamping
 **re: Standard corner radius

SPARE PARTS

Designation	Clamp	Clamp screw	Spring	Spring pin	Shim	Shim screw	Wrench
ATFNR/L*3-A, 16-A	ACP3S	ACS-5W	BP-7	SP-2.5	AST322	CSTB-3.5	T-15F
ATFNR/L*22-A	ACP4S	ACS-5W	BP-7	SP-2.5	AST422	CSTB-3.5	T-15F

Reference pages

ASDNN, ASSNR/L: Inserts → **B073 -**, CBN → **B166**, PCD → **B178**

ASKNR/L: Inserts → **B073 -**, CBN → **B166**, PCD → **B178**

ATFNR/L: Inserts → **B082 -**, CBN → **B166 -**, PCD → **B178**



TURNINGA

ADQNR/L

Double-clamp toolholder with 107.5° approach angle, for negative 55° rhombic inserts

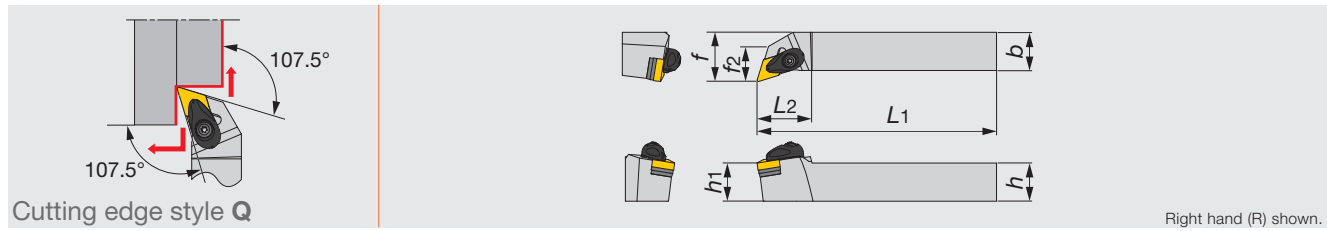

Inch	h	b	L1	L2	h1	f	f2	re**	Insert	Torque*
ADQNR/L124-A	0.750	0.750	4.500	1.250	0.750	1.000	-	0.031	DN**43...	2.2
ADQNR/L164-A	1.000	1.000	6.000	1.500	1.000	1.250	-	0.031	DN**43...	2.2
Metric	h	b	L1	L2	h1	f	f2	re**	Insert	Torque*
ADQNR/L2020K15-A	20	20	125	32	20	25	21	0.8	DN**1504...	3
ADQNR/L2020K1506-A	20	20	125	32	20	25	21	0.8	DN**1506...	3
ADQNR/L2525M15-A	25	25	150	36	25	32	23	0.8	DN**1504...	3
ADQNR/L2525M1506-A	25	25	150	36	25	32	23	0.8	DN**1506...	3

*Torque: Recommended torque (lbf-ft, N-m) for clamping
 **re: Standard corner radius

SPARE PARTS

Designation	Clamp	Clamp screw	Spring	Spring pin	Shim	Shim screw	Wrench
ADQNR/L**4-A, 15-A	ACP4S	ACS-5W	BP-7	SP-2.5	ASD432	CSTB-3.5	T-15F
ADQNR/L**1506-A	ACP4S	ACS-5W	BP-7	SP-2.5	ASD423	CSTB-3.5	T-15F

TURNINGA

ATQNR/L

Double-clamp toolholder with 105° approach angle, for negative triangle inserts

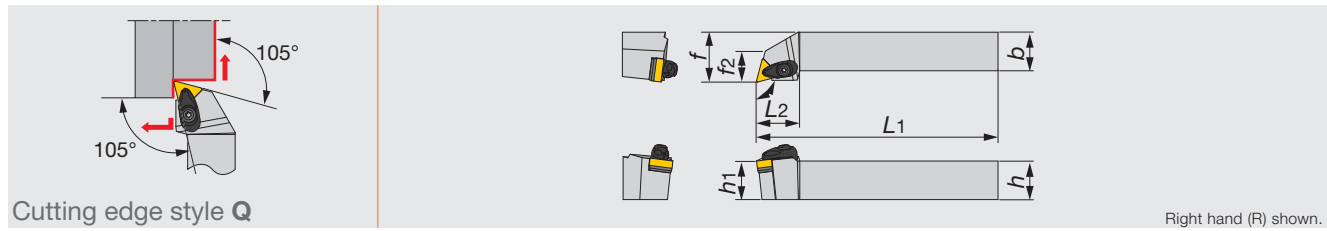

Inch	h	b	L1	L2	h1	f	f2	re**	Insert	Torque*
ATQNR/L123-A	0.750	0.750	4.500	1.125	0.750	1.000	0.700	0.031	TN**33...	2.2
ATQNR/L163-A	1.000	1.000	6.000	1.125	1.000	1.250	0.750	0.031	TN**33...	2.2
Metric	h	b	L1	L2	h1	f	f2	re**	Insert	Torque*
ATQNR/L2020K16-A	20	20	125	28	20	25	18	0.8	TN**1604...	3
ATQNR/L2525M16-A	25	25	150	28	25	32	20	0.8	TN**1604...	3

*Torque: Recommended torque (lbf-ft, N-m) for clamping
 **re: Standard corner radius

SPARE PARTS

Designation	Clamp	Clamp screw	Spring	Spring pin	Shim	Shim screw	Wrench
ATQNR/L**3-A, 16-A	ACP3S	ACS-5W	BP-7	SP-2.5	AST322	CSTB-3.5	T-15F

Reference pages

ADQNR/L: Inserts → **B063** -, CBN → **B165** -, PCD → **B178**ATQNR/L: Inserts → **B082** -, CBN → **B166** -, PCD → **B178**

Double-clamp toolholder with 117.5° approach angle, for negative 35° or 25° rhombic inserts

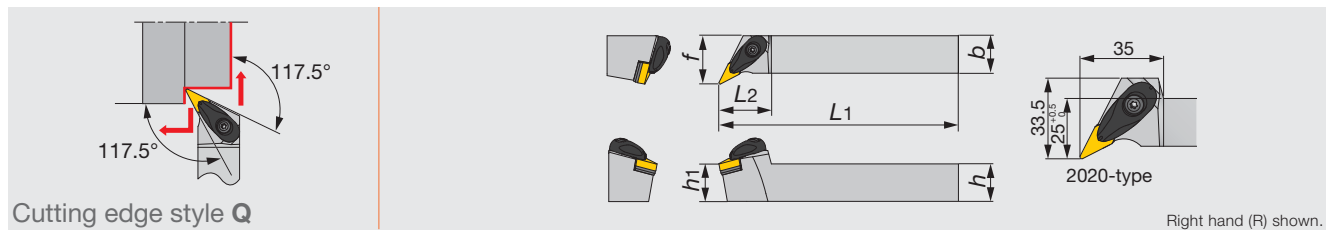

Inch	<i>h</i>	<i>b</i>	<i>L</i> ₁	<i>L</i> ₂	<i>h</i> ₁	<i>f</i>	<i>r</i> _ε **	Insert	Torque*
AVQNR/L123-A	0.750	0.750	4.500	1.380	0.750	1.000	0.031	V/YN**33...	2.2
AVQNR/L163-A	1.000	1.000	6.000	1.380	1.000	1.250	0.031	V/YN**33...	2.2
Metric	<i>h</i>	<i>b</i>	<i>L</i> ₁	<i>L</i> ₂	<i>h</i> ₁	<i>f</i>	<i>r</i> _ε **	Insert	Torque*
AVQNR/L2020K16-A	20	20	125	35	20	25	0.8	V/YN**1604...	3
AVQNR/L2525M16-A	25	25	150	35	25	32	0.8	V/YN**1604...	3

*Torque: Recommended torque (lbf-ft, N-m) for clamping
 ***r*_ε: Standard corner radius

SPARE PARTS

Designation	Clamp	Clamp screw	Spring	Spring pin	Shim	Shim screw	Wrench
AVQNR/L...	ACP3L	ACS-5W	BP-7	SP-2.5	ASV322	CSTB-3.5	T-15F

Double-clamp toolholder with 91° approach angle, for negative round inserts

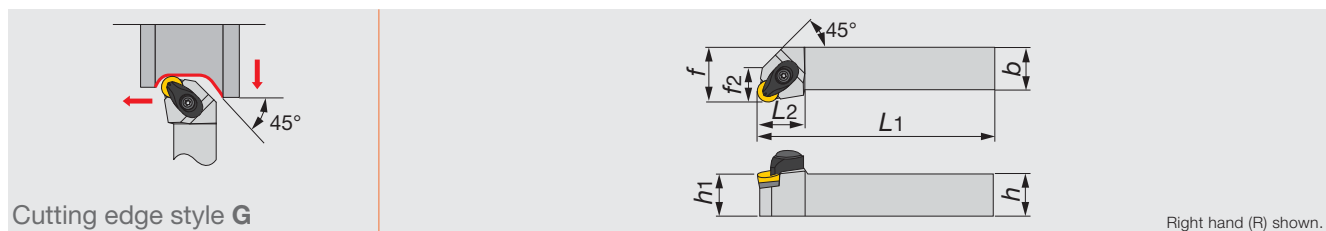

Inch	<i>h</i>	<i>b</i>	<i>L</i> ₁	<i>L</i> ₂	<i>h</i> ₁	<i>f</i>	<i>f</i> ₂	<i>r</i> _ε **	Insert	Torque*
ARGNR/L164-A	1.000	1.000	6.000	1.125	1.000	1.250	0.750	0.250	RN**43...	2.2
Metric	<i>h</i>	<i>b</i>	<i>L</i> ₁	<i>L</i> ₂	<i>h</i> ₁	<i>f</i>	<i>f</i> ₂	<i>r</i> _ε **	Insert	Torque*
ARGNR/L2525M12-A	25	25	150	28	25	32	20	6.35	RN**120400	3

*Torque: Recommended torque (lbf-ft, N-m) for clamping
 ***r*_ε: Standard corner radius

SPARE PARTS

Designation	Clamp	Clamp screw	Spring	Spring pin	Shim	Shim screw	Wrench
ARGNR/L...	ACP4S	ACS-5W	BP-7	SP-2.5	ASR420	CSTB-3.5	T-15F

Reference pages

AVQNR/L: Inserts → **B093-**, **B104**, CBN → **B167 -**, PCD → **B178**

ARGNR/L: Inserts → **B072**



TUNG TURN

PCLNR/L-CHP

Lever lock type toolholder with 95° approach angle, for negative 80° rhombic inserts, with channels for high pressure coolant

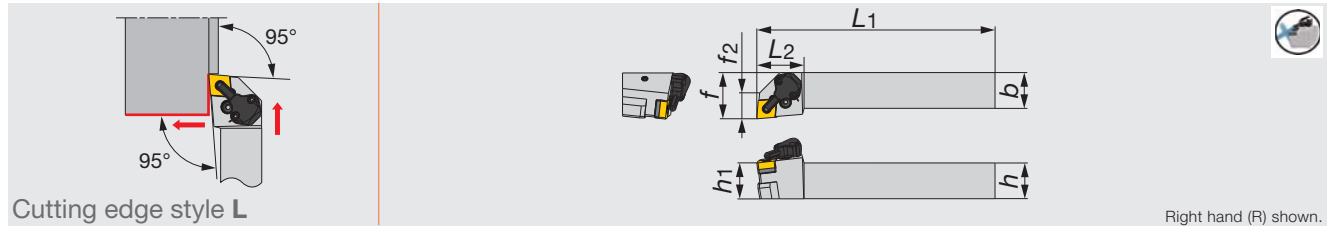





Right hand (R) shown.

Inch	<i>h</i>	<i>b</i>	<i>L1</i>	<i>L2</i>	<i>h1</i>	<i>f</i>	<i>f2</i>	<i>r_e**</i>	Insert	Torque*
PCLNR/L1233-CHP	0.750	0.750	4.500	1.300	0.750	1.250	0.750	0.031	CN**33...	1.5
PCLNR/L124-CHP	0.750	0.750	4.500	1.300	0.750	1.250	0.750	0.031	CN**43...	2.2
PCLNR/L1633-CHP	1.000	1.000	6.000	1.300	1.000	1.250	0.750	0.031	CN**33...	1.5
PCLNR/L164-CHP	1.000	1.000	6.000	1.300	1.000	1.250	0.750	0.031	CN**43...	2.2
Metric	<i>h</i>	<i>b</i>	<i>L1</i>	<i>L2</i>	<i>h1</i>	<i>f</i>	<i>f2</i>	<i>r_e**</i>	Insert	Torque*
PCLNR/L2020K0904-CHP	20	20	125	33	20	32	18	0.8	CN**0904...	2
PCLNR/L2020K12-CHP	20	20	125	33	20	32	18	0.8	CN**1204...	3
PCLNR/L2525M0904-CHP	25	25	150	33	25	32	18	0.8	CN**0904...	2
PCLNR/L2525M12-CHP	25	25	150	33	25	32	18	0.8	CN**1204...	3







*Torque: Recommended torque (lbf-ft, N-m) for clamping

***r_e*: Standard corner radius

SPARE PARTS

Designation	 Shim	 Clamping screw	 Wrench 1	 Spring pin	 Lever
PCLNR/L**0904-CHP, PCLNR/L**33-CHP	LSC317	LCS3	P-2.5	LSP3	LCL33
PCLNR/L**12-CHP, PCLNR/L**4-CHP	LSC42	LCS4	P-3	LSP4	LCL4

SPARE PARTS

Designation	 Coolant unit	 Mounting screw	 Wrench 2	 O-ring	 Coolant screw	 Wrench 3
PCLNR/L**0904-CHP, PCLNR/L**33-CHP	CU-CW-CHP	SRM3	T-8F	OR6.4X0.9N	SRM4X4TL360	P-2
PCLNR/L**12-CHP, PCLNR/L**4-CHP	CU-CW-CHP	SRM3	T-8F	OR6.4X0.9N	SRM4X4TL360	P-2

Reference pages

PCLNR/L-CHP: Inserts → B052 -, CBN → B165 -, PCD → B178

Lever lock type toolholder with 93° approach angle, for negative 55° rhombic inserts, with channels for high pressure coolant

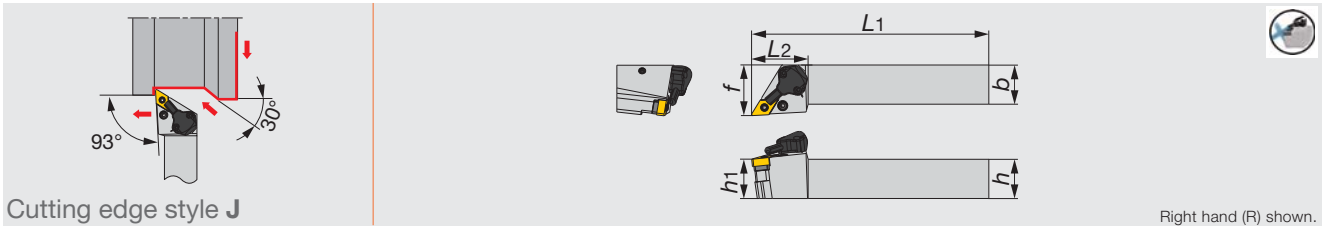

Cutting edge style J

Right hand (R) shown.

Inch	h	b	L1	L2	h1	f	re**	Insert	Torque*
PDJNR/L1233-CHP	0.750	0.750	4.500	1.420	0.750	1.250	0.031	DN**33...	1.5
PDJNR/L124-CHP	0.750	0.750	4.500	1.420	0.750	1.250	0.031	DN**43...	2.2
PDJNR/L1633-CHP	1.000	1.000	6.000	1.420	1.000	1.250	0.031	DN**33...	1.5
PDJNR/L164-CHP	1.000	1.000	6.000	1.420	1.000	1.250	0.031	DN**43...	2.2
Metric	h	b	L1	L2	h1	f	re**	Insert	Torque*
PDJNR/L2020K1104-CHP	20	20	125	36	20	32	0.8	DN**1104...	2
PDJNR/L2020K15-CHP	20	20	125	36	20	32	0.8	DN**1504...	3
PDJNR/L2525M1104-CHP	25	25	150	36	25	32	0.8	DN**1104...	2
PDJNR/L2525M15-CHP	25	25	150	36	25	32	0.8	DN**1504...	3

*Torque: Recommended torque (lbf-ft, N-m) for clamping

**re: Standard corner radius

SPARE PARTS

Designation	Shim	Clamping screw	Wrench 1	Spring pin	Lever
PDJNR/L**1104-CHP, PDJNR/L**33-CHP	ELSD32	LCS3	P-2.5	LSP3	LCL33L
PDJNR/L**15-CHP, PDJNR/L**4-CHP	LSD43A	LCS4	P-3	LSP4	LCL4

SPARE PARTS

Designation	Coolant unit	Mounting screw	Wrench 2	O-ring	Coolant screw	Wrench 3
PDJNR/L**1104-CHP, PDJNR/L**33-CHP	CU-D-CHP	SRM3	T-8F	OR6.4X0.9N	SRM4X4TL360	P-2
PDJNR/L**15-CHP, PDJNR/L**4-CHP	CU-D-CHP	SRM3	T-8F	OR6.4X0.9N	SRM4X4TL360	P-2

Reference pages

PDJNR/L-CHP: Inserts → B063 -, CBN → B165 -, PCD → B178



TUNG TURN

PTGJR/L-CHP

Lever lock type toolholders with 91° approach angle. For negative triangle insert. High-pressure coolant capability.

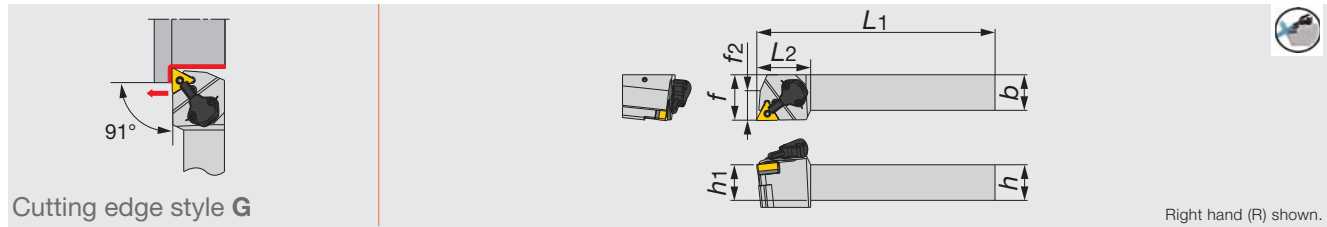

Cutting edge style G

Right hand (R) shown.

Inch	h	b	L1	L2	h1	f	f2	re**	Insert	Torque*
PTGJR/L1223-CHP	0.750	0.750	4.500	1.500	0.750	1.250	0.813	0.031	TN**23...	1.5
PTGJR/L123-CHP	0.750	0.750	4.500	1.500	0.750	1.250	0.813	0.031	TN**33...	1.5
PTGJR/L1623-CHP	1.000	1.000	6.000	1.500	1.000	1.250	0.813	0.031	TN**23...	1.5
PTGJR/L163-CHP	1.000	1.000	6.000	1.500	1.000	1.250	0.813	0.031	TN**33...	1.5

Metric	h	b	L1	L2	h1	f	f2	re**	Insert	Torque*
PTGJR/L2020K1104-CHP	20	20	125	38	20	32	21	0.8	TN**1104...	2
PTGJR/L2020K16-CHP	20	20	125	38	20	32	21	0.8	TN**1604...	2
PTGJR/L2525M1104-CHP	25	25	150	38	25	32	21	0.8	TN**1104...	2
PTGJR/L2525M16-CHP	25	25	150	38	25	32	21	0.8	TN**1604...	2

*Torque: Recommended torque (lb-ft, N-m) for clamping

**re: Standard corner radius

SPARE PARTS

Designation	Shim	Clamping screw	Wrench 1	Spring pin	Lever
PTGJR/L**1104-CHP, PTGJR/L**23-CHP	-	LCS23A	P-2.5	LSP3	LCL23
PTGJR/L**16-CHP, PTGJR/L**3-CHP	LST317	LCS3	P-2.5	LSP3	LCL3

SPARE PARTS

Designation	Coolant unit	Mounting screw	Wrench 2	O-ring	Coolant screw	Wrench 3
PTGJR/L**1104-CHP, PTGJR/L**23-CHP	CU-CW-CHP	SRM3	T-8F	OR6.4X0.9N	SRM4X4TL360	P-2
PTGJR/L**16-CHP, PTGJR/L**3-CHP	CU-CW-CHP	SRM3	T-8F	OR6.4X0.9N	SRM4X4TL360	P-2

Reference pages

PTGJR/L-CHP: Inserts → B082 -, CBN → B166 -, PCD → B178

TUNG T^{URN} T^{JET}

PVJNR/L-CHP

Lever lock type toolholders with 93° approach angle. For negative 35° or 25° rhombic insert.
High-pressure coolant capability.

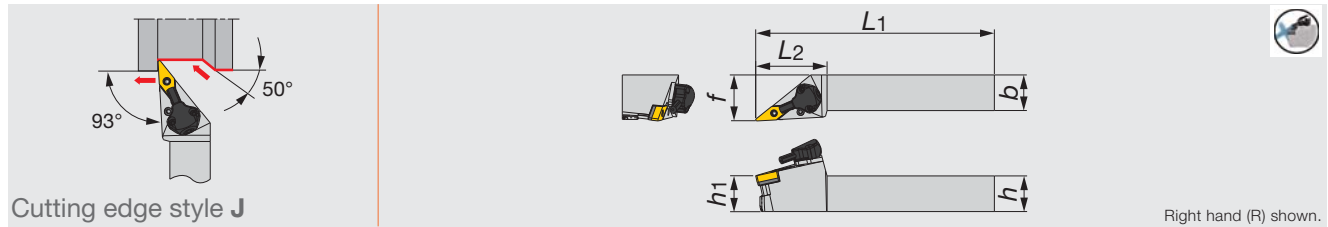

Inch	h	b	L1	L2	h1	f	re**	Insert	Torque*
PVJNR/L122.33-CHP	0.750	0.750	4.500	2.000	0.750	1.250	0.031	VN**2.33**E...	1.5
PVJNR/L162.33-CHP	1.000	1.000	6.000	2.000	1.000	1.250	0.031	VN**2.33**E...	1.5
PVJNR/L123-CHP	0.750	0.750	4.500	1.344	0.750	1.250	0.031	V/YN**33...	1.5
PVJNR/L163-CHP	1.000	1.000	6.000	1.344	1.000	1.250	0.031	V/YN**33...	1.5
Metric	h	b	L1	L2	h1	f	re**	Insert	Torque*
PVJNR/L2020K1204-CHP	20	20	125	50	25	32	0.8	VN**1204...	2
PVJNR/L2525M1204-CHP	25	25	150	50	25	32	0.8	VN**1204...	2
PVJNR/L2020K16-CHP	20	20	125	50	20	32	0.8	V/YN**1604...	2
PVJNR/L2525M16-CHP	25	25	150	50	25	32	0.8	V/YN**1604...	2

*Torque: Recommended torque (lbf-ft, N-m) for clamping **re: Standard corner radius

SPARE PARTS

Designation	Shim	Clamping screw	Wrench 1	Spring pin	Lever
PVJNR/L**1204-CHP PVJNR/L**2.33-CHP	LSV212	LCS3V	P-2.5	LSP3	LCL3V
PVJNR/L**16-CHP PVJNR/L**3-CHP	LSV317	LCS3V	P-2.5	LSP3	LCL3V

SPARE PARTS

Designation	Coolant unit	Mounting screw	Wrench 2	O-ring	Coolant screw	Wrench 3
PVJNR/L**1204-CHP PVJNR/L**2.33-CHP	CU-V-CHP	SRM3	T-8F	OR6.4X0.9N	SRM4X4TL360	P-2
PVJNR/L**16-CHP PVJNR/L**3-CHP	CU-V-CHP	SRM3	T-8F	OR6.4X0.9N	SRM4X4TL360	P-2

TUNG T^{URN} T^{JET}

PVQNR/L-CHP

Lever lock type toolholders with 117.5° approach angle. For negative 35° or 25° rhombic insert.
High-pressure coolant capability.

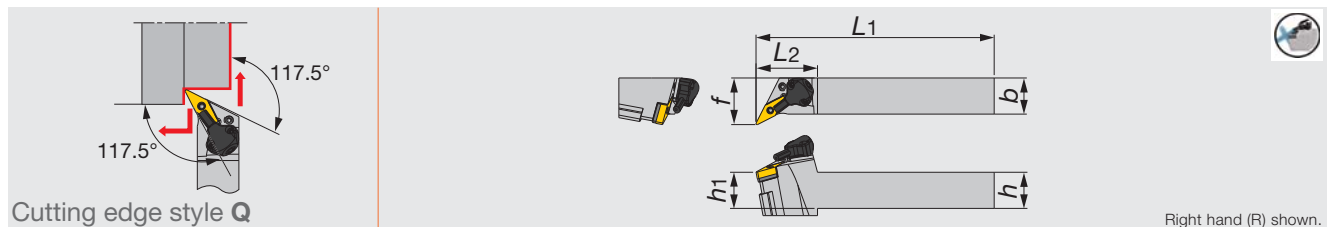

Inch	h	b	L1	L2	h1	f	re**	Insert	Torque*
PVQNR/L123-CHP	0.750	0.750	4.500	1.344	0.750	1.250	0.031	V/YN**33...	1.5
PVQNR/L163-CHP	1.000	1.000	6.000	1.344	1.000	1.250	0.031	V/YN**33...	1.5
Metric	h	b	L1	L2	h1	f	re**	Insert	Torque*
PVQNR/L2020K16-CHP	20	20	125	42.5	20	32	0.8	V/YN**1604...	2
PVQNR/L2525M16-CHP	25	25	150	42.5	25	32	0.8	V/YN**1604...	2

*Torque: Recommended torque (lbf-ft, N-m) for clamping **re: Standard corner radius

SPARE PARTS

Designation	Shim	Clamping screw	Wrench 1	Spring pin	Lever
PVQNR/L**-CHP	LSV317	LCS3V	P-2.5	LSP3	LCL3V

SPARE PARTS

Designation	Coolant unit	Mounting screw	Wrench 2	O-ring	Coolant screw	Wrench 3
PVQNR/L**-CHP	CU-V-CHP	SRM3	T-8F	OR6.4X0.9N	SRM4X4TL360	P-2

Reference pages

PVJNR/L-CHP, PVQNR/L-CHP: Inserts → B093 -, B104, CBN → B167 -, PCD → B178



Ext. Toolholder



TUNGTURN

PWLNR/L-CHP

Lever lock type toolholders with 95° approach angle. For negative 80° trigon insert. High-pressure coolant capability.

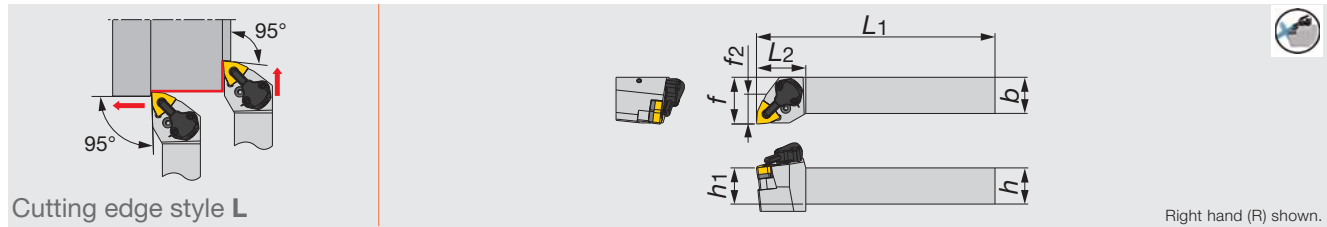

Cutting edge style L

Right hand (R) shown.

Inch	<i>h</i>	<i>b</i>	<i>L</i> ₁	<i>L</i> ₂	<i>h</i> ₁	<i>f</i>	<i>f</i> ₂	<i>r</i> _e **	Insert	Torque*
PWLNR/L1233-CHP	0.750	0.750	4.500	1.969	0.750	1.250	0.781	0.031	WN**33...	1.5
PWLNR/L124-CHP	0.750	0.750	4.500	1.969	0.750	1.250	0.781	0.031	WN**43...	1.5
PWLNR/L1633-CHP	1.000	1.000	6.000	1.969	1.000	1.250	0.781	0.031	WN**33...	1.5
PWLNR/L164-CHP	1.000	1.000	6.000	1.969	1.000	1.250	0.781	0.031	WN**43...	1.5
Metric	<i>h</i>	<i>b</i>	<i>L</i> ₁	<i>L</i> ₂	<i>h</i> ₁	<i>f</i>	<i>f</i> ₂	<i>r</i> _e **	Insert	Torque*
PWLNR/L2020K0604-CHP	20	20	125	34	20	32	20	0.8	WN**0604...	2
PWLNR/L2020K08-CHP	20	20	125	34	20	32	20	0.8	WN**0804...	3
PWLNR/L2525M0604-CHP	25	25	150	34	25	32	20	0.8	WN**0604...	2
PWLNR/L2525M08-CHP	25	25	150	34	25	32	20	0.8	WN**0804...	3

*Torque: Recommended torque (lbf-ft, N-m) for clamping

**re: Standard corner radius

SPARE PARTS

Designation					
PWLNR/L**0604-CHP, PWLNR/L**33-CHP	LSW312	LCS3	P-2.5	LSP3	LCL3
PWLNR/L**08-CHP, PWLNR/L**4-CHP	LSW42	LCS4	P-2.5	LSP4	LCL4

SPARE PARTS

Designation						
PWLNR/L**0604-CHP, PWLNR/L**33-CHP	CU-CW-CHP	SRM3	T-8F	OR6.4X0.9N	SRM4X4TL360	P-2
PWLNR/L**08-CHP, PWLNR/L**4-CHP	CU-CW-CHP	SRM3	T-8F	OR6.4X0.9N	SRM4X4TL360	P-2

Reference pages

PWLNR/L-CHP: Inserts → **B097 -**, CBN → **B167**

Lever lock type toolholder with TungCap connection, for negative inserts, C 80° rhombic with channels for high pressure coolant

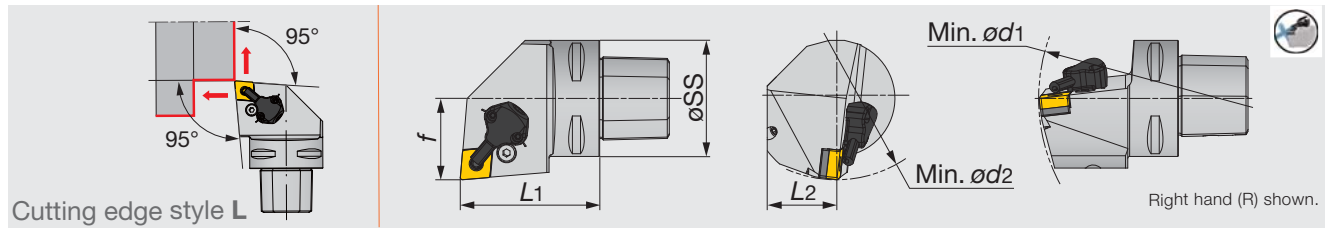

Inch	øSS	L1	L2	f	ød1	ød2	r _ε **	Insert
C4PCLNR/L27050-0904CHP	1.575	1.969	0.984	1.063	5.512	4.331	0.031	CN**33...
C4PCLNR/L27050-12CHP	1.575	1.969	0.984	1.063	5.512	4.331	0.031	CN**43...
C5PCLNR/L35060-12CHP	1.969	2.362	1.260	1.378	6.496	4.331	0.031	CN**43...
C6PCLNR/L45065-0904CHP	2.480	2.559	1.614	1.772	7.480	4.921	0.031	CN**33...
C6PCLNR/L45065-12CHP	2.480	2.559	1.614	1.772	7.480	4.921	0.031	CN**43...
Metric	øSS	L1	L2	f	ød1	ød2	r _ε **	Insert
C4PCLNR/L27050-0904-CHP	40	50	25	27	140	110	0.8	CN**0904...
C4PCLNR/L27050-12-CHP	40	50	25	27	140	110	0.8	CN**1204...
C5PCLNR/L35060-12-CHP	50	60	32	35	165	110	0.8	CN**1204...
C6PCLNR/L45065-0904-CHP	63	65	41	45	190	125	0.8	CN**0904...
C6PCLNR/L45065-12-CHP	63	65	41	45	190	125	0.8	CN**1204...

**re: Standard corner radius

Lever lock type toolholder with TungCap connection, for negative inserts, D 55° rhombic with channels for high pressure coolant

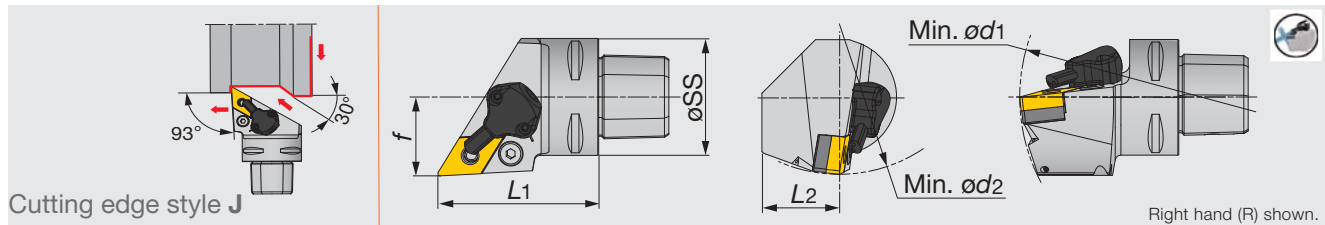

Inch	øSS	L1	L2	f	ød1	ød2	r _ε **	Insert
C4PDJNR/L27050-1104CHP	1.575	1.969	0.984	1.063	5.512	4.331	0.031	DN**33...
C4PDJNR/L27050-15CHP	1.575	1.969	0.984	1.063	5.512	4.331	0.031	DN**43...
C5PDJNR/L35060-15CHP	1.969	2.362	1.260	1.378	6.496	4.331	0.031	DN**43...
C6PDJNR/L45065-1104CHP	2.480	2.559	1.614	1.772	7.480	4.331	0.031	DN**33...
C6PDJNR/L45065-15CHP	2.480	2.559	1.614	1.772	7.480	4.331	0.031	DN**43...
Metric	øSS	L1	L2	f	ød1	ød2	r _ε **	Insert
C4PDJNR/L27050-1104-CHP	40	50	25	27	140	110	0.8	DN**1104...
C4PDJNR/L27050-15-CHP	40	50	25	27	140	110	0.8	DN**1504(06)...
C5PDJNR/L35060-15-CHP	50	60	32	35	165	110	0.8	DN**1504(06)...
C6PDJNR/L45065-1104-CHP	63	65	41	45	190	110	0.8	DN**1104...
C6PDJNR/L45065-15-CHP	63	65	41	45	190	110	0.8	DN**1504(06)...

**re: Standard corner radius

SPARE PARTS FOR P-TYPE

Designation	Shim	Clamping screw	Wrench 1	Spring pin	Lever
C*PCLNR/L**12-CHP	LSC42	LCS4	P-3	LSP4	LCL4
C*PDJNR/L**15-CHP	LSD43A	LCS4	P-3	LSP4	LCL4
C*PCLNR/L**0904-CHP	LSC317	LCS3	P-2.5	LSP3	LCL33
C*PDJNR/L**1104-CHP	ELSD32	LCS3	P-2.5	LSP3	LCL33L

COOLANT SET

Designation	Coolant unit	Mounting screw	Wrench 2	O-ring
C*PCLNR/L**12-CHP	CU-CW-CHP	SRM3	T-8F	OR6.4X0.9N
C*PDJNR/L**15-CHP	CU-D-CHP	SRM3	T-8F	OR6.4X0.9N

Reference pages

C-PCLN-CHP: Inserts → B052 -, CBN → B165 -, PCD → B178

C-PDJN-CHP: Inserts → B063 -, CBN → B165 -, PCD → B178





TUNG T^{URN}JET

C-PWLN-CHP

Lever lock type toolholder with TungCap connection, for negative inserts, W 80° trigon with channels for high pressure coolant

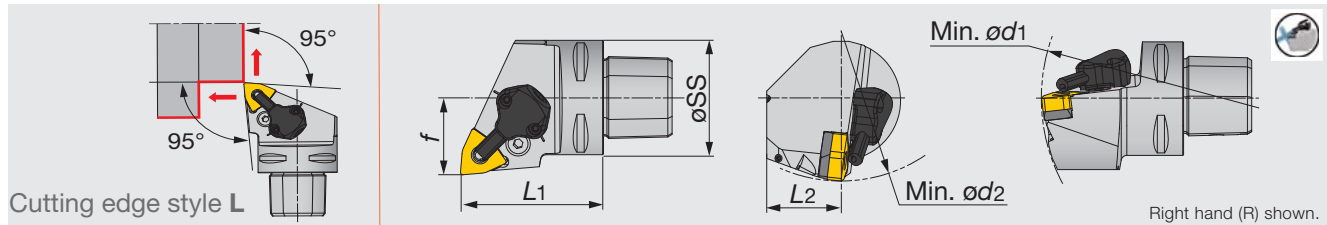

Inch	øSS	L1	L2	f	ød1	ød2	r _E **	Insert
C4PWLNR/L27050-0604CHP	1.575	1.969	0.984	1.063	5.512	4.331	0.031	WN**33...
C4PWLNR/L27050-08CHP	1.575	1.969	0.984	1.063	5.512	4.331	0.031	WN**43...
C6PWLNR/L45065-08CHP	2.480	2.559	1.614	1.772	7.480	4.331	0.031	WN**43...
Metric	øSS	L1	L2	f	ød1	ød2	r _E **	Insert
C4PWLNR/L27050-0604-CHP	40	50	25	27	140	110	0.8	WN**0604...
C4PWLNR/L27050-08-CHP	40	50	25	27	140	110	0.8	WN**0804...
C6PWLNR/L45065-08-CHP	63	65	41	45	190	110	0.8	WN**0804...

**re: Standard corner radius

SPARE PARTS FOR P-TYPE

Designation	Shim	Clamping screw	Wrench 1	Spring pin	Lever
C*PWLNR/L**08-CHP	LSW42BL	LCS4	P-3	LSP4	LCL4
C*PWLNR/L**0604-CHP	LSW312	LCS3	P-2.5	LSP3	LCL3

COOLANT SET

Designation	Coolant unit	Mounting screw	Wrench 2	O-ring
C*PWLNR/L**08-CHP	CU-CW-CHP	SRM3	T-8F	OR6.4X0.9N

TUNG T^{URN}JET

C-PVJNR/L-CHP

Lever lock toolholders with TungCap connection – 93° approach angle. For negative 35° or 25° rhombic insert. High-pressure coolant capability.

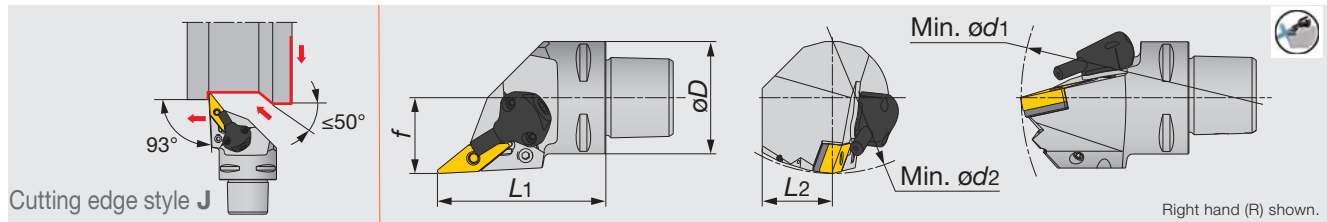

Inch	øD	L1	L2	f	ød1	ød2	r _E **	Insert
C4PVJNR/L27060-1204-CHP	1.575	2.362	0.787	1.063	5.512	3.543	0.031	VN**2.33**E...
C4PVJNR/L27060-16-CHP	1.575	2.362	-	1.063	5.512	4.331	0.031	V/YN**33...
C6PVJNR/L45065-1204-CHP	2.480	2.559	1.240	1.772	7.480	3.189	0.031	VN**2.33**E...
C6PVJNR/L45065-16-CHP	2.480	2.559	-	1.772	7.480	3.189	0.031	V/YN**33...
Metric	øD	L1	L2	f	ød1	ød2	r _E **	Insert
C4PVJNR/L27060-1204-CHP	40	60	20	27	140	90	0.8	VN**1204...
C4PVJNR/L27060-16-CHP	40	60	-	27	140	110	0.8	V/YN**1604...
C6PVJNR/L45065-1204-CHP	63	65	31.5	45	190	81	0.8	VN**1204...
C6PVJNR/L45065-16-CHP	63	65	-	45	190	81	0.8	V/YN**1604...

Applicable for 14 MPa pressure coolant. **re: Standard corner radius

SPARE PARTS

Designation	Shim	Clamping screw	Wrench	Wrench 1	Spring pin	Lever
C*PVJNR/L**1204-CHP	LSV212	LCS3V	P-2.5	P-3	LSP3	LCL3V
C*PVJNR/L**16-CHP	LSV317	LCS3V	P-2.5	-	LSP3	LCL3V

SPARE PARTS

Designation	Coolant unit	Mounting screw	Wrench 2	O-ring
C*PVJNR/L**08-CHP	CU-V-CHP	SRM3	T-8F	OR6.4X0.9N

Reference pages

C-PWLN-CHP: Inserts → **B097 -**, CBN → **B167**

C-PVJNR/L-CHP: Inserts → **B093 -**, **B104**, CBN → **B167 -**, PCD → **B178**

Lever lock toolholder with TungCap connection. For negative 80° rhombic insert. High-pressure coolant capability.

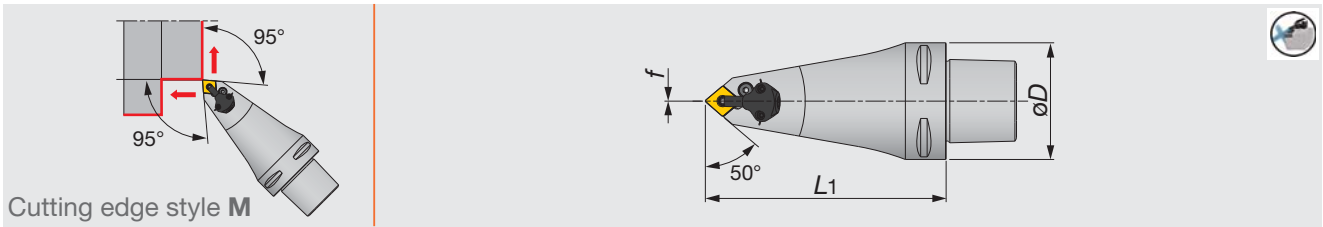

Metric	<i>h</i>	<i>b</i>	<i>L1</i>	<i>L2</i>	Insert
C6PCMNN00130-12-CHP	63	115	0	0.8	CN**1204...

Applicable for 14 MPa pressure coolant
**re: Standard corner radius

For external turning only.

SPARE PARTS

Designation	Shim	Clamping screw	Wrench 1	Spring pin	Lever
C6PCMNN00130-12-CHP	LSC42	LCS4	P-3	LSP4	LCL4

SPARE PARTS

Designation	Coolant unit	Mounting screw	Wrench 2	O-ring
C6PCMNN00130-12-CHP	CU-CW-CHP	SRM3	T-8F	OR6.4X0.9N

Reference pages

C-PCMNN-CHP: Inserts → B052 -, CBN → B165 -, PCD → B178



TUNG T^{URN} JET

C-PDMNL-CHP

Lever lock toolholder with TungCap connection. For negative 55° rhombic insert. High-pressure coolant capability.

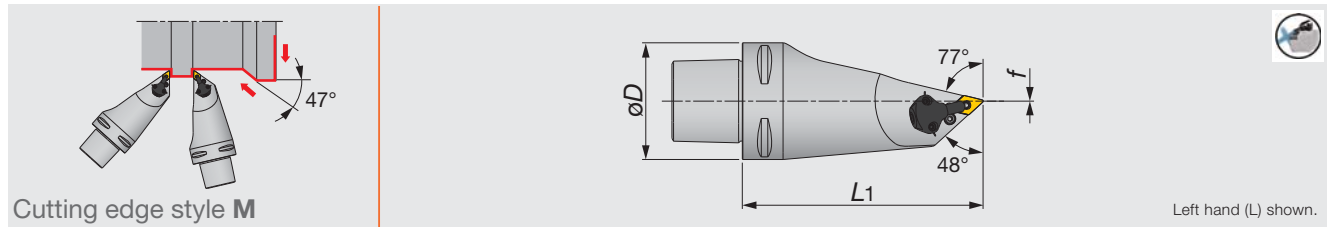





Metric	$\varnothing D$	$L1$	f	$r\epsilon^{**}$	Insert
C6PDMNL00130-1104-CHP	63	130	0	0.8	DN**1104...

Applicable for 14 MPa pressure coolant
**re: Standard corner radius

For external turning only.

SPARE PARTS

Designation					
C6PDMNL00130-1104-CHP	Shim ELSD32	Clamping screw LCS3	Wrench 1 P-2.5	Spring pin LSP3	Lever LCL33L

SPARE PARTS

Designation				
C6PDMNL00130-1104-CHP	Coolant unit CU-D-CHP	Mounting screw SRM3	Wrench 2 T-8F	O-ring OR6.4X0.9N

Reference pages

C-PDMNL-CHP: Inserts → **B063 -**, CBN → **B165 -**, PCD → **B178**

TUNG T^{URN}JET

JSDJ2XR/L-CHP

Screw-on toolholder without offset with 93° approach angle, for DXGU inserts, with channels for high pressure coolant

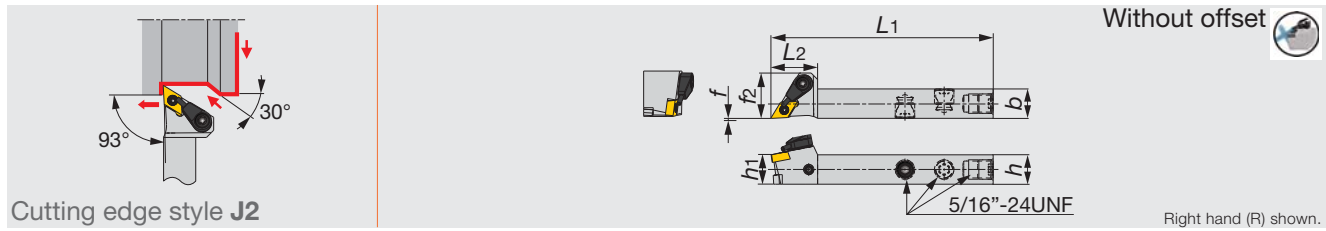

Inch	h	b	L1	L2	h1	f	f2	rε**	Insert	Torque*
JSDJ2XR/L082-CHP	0.500	0.500	3.344	0.750	0.500	0.500	0.730	0.008	DXGU22**/L/R...	0.7
Metric	h	b	L1	L2	h1	f	f2	rε**	Insert	Torque*
JSDJ2XR/L1212F07-CHP	12	12	85	19	12	0	18.5	0.2	DXGU0703**/L/R...	0.9

*Torque: Recommended torque (lbf-ft, N-m) for clamping **re: Standard corner radius
 Note: Right-hand toolholders (R) are used with left-hand inserts (L). Left-hand toolholders (L) are used with right-hand inserts (R).

SPARE PARTS			
Designation	Clamping screw	Coolant unit	Wrench
JSDJ2XR/L*-CHP	SR34-514	S-CU-CHP	T-7F

TUNG T^{URN}JET

JSWL2XR/L-CHP

Screw-on toolholder without offset with 95° approach angle, for WXGU inserts, with channels for high pressure coolant

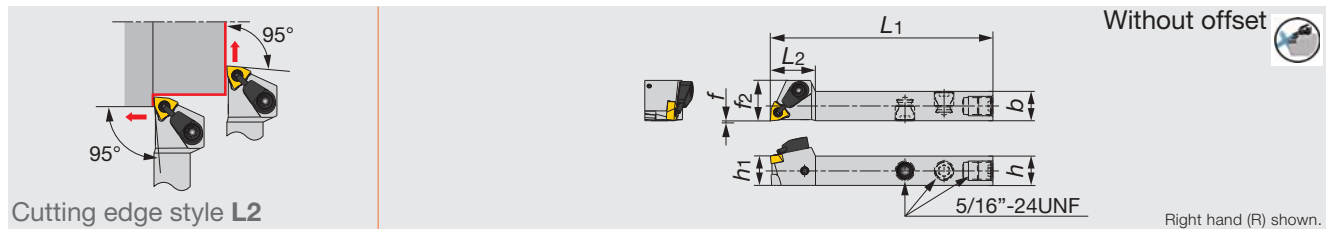

Inch	h	b	L1	L2	h1	f	f2	rε**	Insert	Torque*
JSWL2XR/L082-CHP	0.500	0.500	3.344	0.750	0.500	0.500	0.650	0.008	WXGU22**/L/R...	0.7
Metric	h	b	L1	L2	h1	f	f2	rε**	Insert	Torque*
JSWL2XR/L1212F04-CHP	12	12	85	18	12	0	16.5	0.2	WXGU0403**/L/R...	0.9

*Torque: Recommended torque (lbf-ft, N-m) for clamping **re: Standard corner radius
 Note: Right-hand toolholders (R) are used with left-hand inserts (L). Left-hand toolholders (L) are used with right-hand inserts (R).

SPARE PARTS			
Designation	Clamping screw	Coolant unit	Wrench
JSWL2XR/L*-CHP	SR34-514	S-CU-CHP	T-7F

Reference pages

JSDJ2XR/L-CHP: Inserts → **B122** -

JSWL2XR/L-CHP: Inserts → **B154**



TUNG T^{URN} JET

JSVJ2XR/L-CHP

Screw-on toolholder without offset with 93° approach angle, for VXGU inserts, with coolant nozzle for high pressure

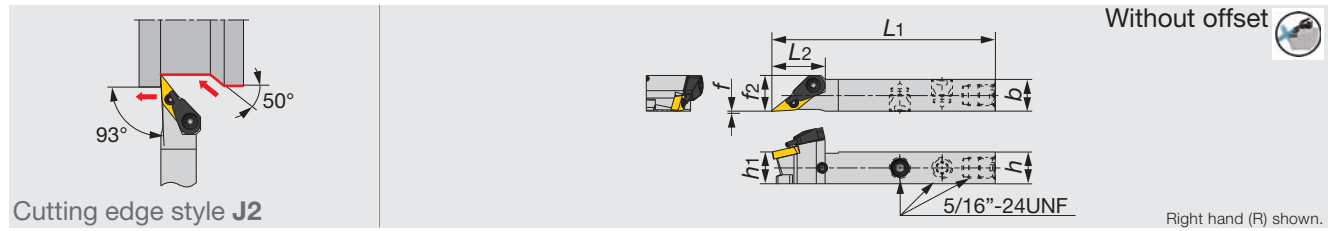

Inch	<i>h</i>	<i>b</i>	<i>L1</i>	<i>L2</i>	<i>h1</i>	<i>f</i>	<i>f2</i>	<i>r_e**</i>	Insert	Torque*
JSVJ2XR/L087-CHP	0.500	0.500	3.344	0.689	0.500	0.500	0.531	0.008	VXGU73.5**/L/R...	0.7
Metric	<i>h</i>	<i>b</i>	<i>L1</i>	<i>L2</i>	<i>h1</i>	<i>f</i>	<i>f2</i>	<i>r_e**</i>	Insert	Torque*
JSVJ2XR/L1212F09-CHP	12	12	85	20	12	0	13.5	0.2	VXGU09T2**/L/R...	0.9

*Torque: Recommended torque (lbf-ft, N-m) for clamping ***r_e*: Standard corner radius
 Note: Right-hand toolholders (R) are used with left-hand inserts (L). Left-hand toolholders (L) are used with right-hand inserts (R).

SPARE PARTS

Designation	Clamping screw	Coolant unit	Wrench
JSVJ2XR/L*-CHP	SR34-508	S-CU-CHP	T-7F

TUNG T^{URN} JET

JSDJ2CR/L-CHP

Screw-on toolholder without offset with 93° approach angle, for positive 55° rhombic inserts, with channels for high pressure coolant

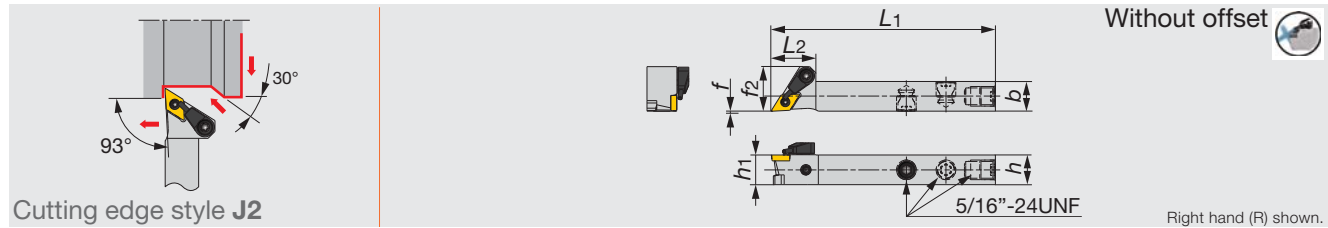

Inch	<i>h</i>	<i>b</i>	<i>L1</i>	<i>L2</i>	<i>h1</i>	<i>f</i>	<i>f2</i>	<i>r_e**</i>	Insert	Torque*
JSDJ2CR/L082-CHP	0.500	0.500	3.344	0.710	0.500	0.500	0.710	0.008	DC**21.5...	0.7
Metric	<i>h</i>	<i>b</i>	<i>L1</i>	<i>L2</i>	<i>h1</i>	<i>f</i>	<i>f2</i>	<i>r_e**</i>	Insert	Torque*
JSDJ2CR/L1212F07-CHP	12	12	85	18	12	0	18	0.2	DC**0702...	0.9
JSDJ2CR/L1212F11-CHP	12	12	85	19	12	0	20.5	0.2	DC**11T3...	0.9

*Torque: Recommended torque (lbf-ft, N-m) for clamping
 ***r_e*: Standard corner radius

SPARE PARTS

Designation	Clamping screw	Coolant unit	Wrench
JSDJ2CR/L082-CHP	CSTB-2.5	S-CU-CHP	T-8F
JSDJ2CR/L1212F07-CHP	CSTB-4SD	S-CU-CHP	T-8F
JSDJ2CR/L1212F11-CHP	CSTB-4SD	S-CU-CHP	T-8F

Reference pages

JSVJ2XR/L-CHP: Inserts → **B152**

JSDJ2CR/L-CHP: Inserts → **B116 -**, CBN → **B170 -**, PCD → **B179**

Screw-on toolholder without offset with 93° approach angle, for positive 35° rhombic inserts, with channels for high pressure coolant

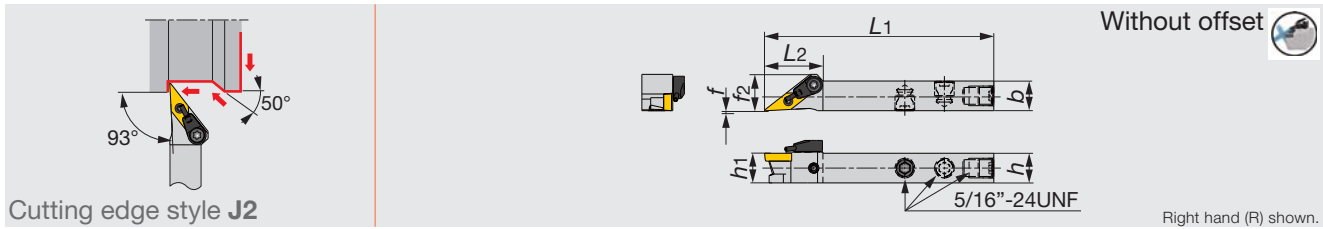

Inch	<i>h</i>	<i>b</i>	<i>L1</i>	<i>L2</i>	<i>h1</i>	<i>f</i>	<i>f2</i>	<i>re**</i>	Insert	Torque*
JSVJ2BR/L082-CHP	0.500	0.500	3.344	0.930	0.500	0.500	0.610	0.008	VB**22...	0.9

Metric	<i>h</i>	<i>b</i>	<i>L1</i>	<i>L2</i>	<i>h1</i>	<i>f</i>	<i>f2</i>	<i>re**</i>	Insert	Torque*
JSVJ2BR/L1212F11-CHP	12	12	85	23.6	12	0	14.7	0.2	VB**1103...	1.2

*Torque: Recommended torque (lb-ft, N-m) for clamping
 **re: Standard corner radius

SPARE PARTS

Designation	Clamping screw	Coolant unit	Wrench
JSVJ2BR/L*-CHP	CSTB-2.5	S-CU-CHP	T-8F

Reference pages

JSVJ2BR/L-CHP: Inserts → B147 -, CBN → B171 -



Connecting hose

Fig. 1

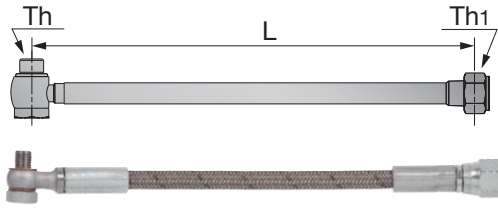
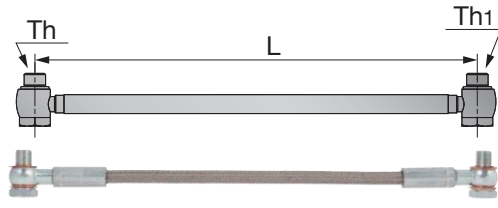
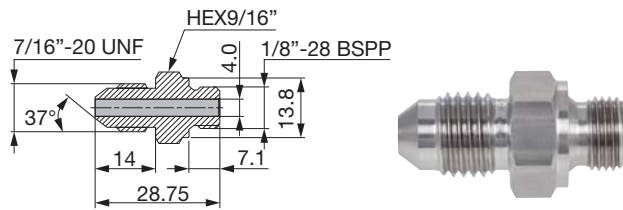

Fig. 2



Metric	L	Th	Th1	Max. pressure (Mpa)	Fig.
CHP-HOSE-G1/8-7/16-200BS	200	G1/8"-28 BSPP	7/16"-20 UNF	26	1
CHP-HOSE-G1/8-7/16-250BS	250	G1/8"-28 BSPP	7/16"-20 UNF	26	1
CHP-HOSE-5/16-7/16-200BS	200	5/16"-24UNF	7/16"-20 UNF	20	1
CHP-HOSE-5/16-G1/8-200BS	200	5/16"-24UNF	G1/8"-28 BSPP	20	1
CHP-HOSE-G1/8-G1/8-200BB	200	G1/8"-28 BSPP	G1/8"-28 BSPP	26	2
CHP-HOSE-G1/8-G1/8-250BB	250	G1/8"-28 BSPP	G1/8"-28 BSPP	26	2

Connector



Metric
CHP-NIPPLE-G1/8-7/16UNF

Seal washer



Metric	øD	ød	W
CHP-COPPER-SEAL1/8	15	10	1
CHP-COPPER-SEAL5/16	11	8	1
CHP-COPPER-SEAL5/16-2.5	11	8	2.5

Connector for small lathe with seal washer

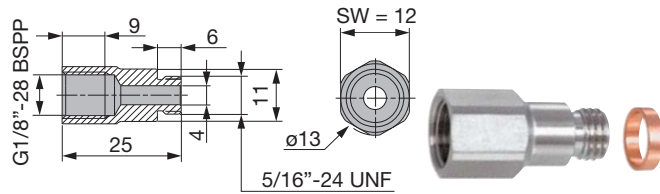

Metric
CHP-CONNECTOR/5/16-G1/8

Y-PRO SERIES

SYJBR/L

Screw-on clamp toolholder with 93° approach angle, for positive 25° rhombic inserts



Ext. Toolholder

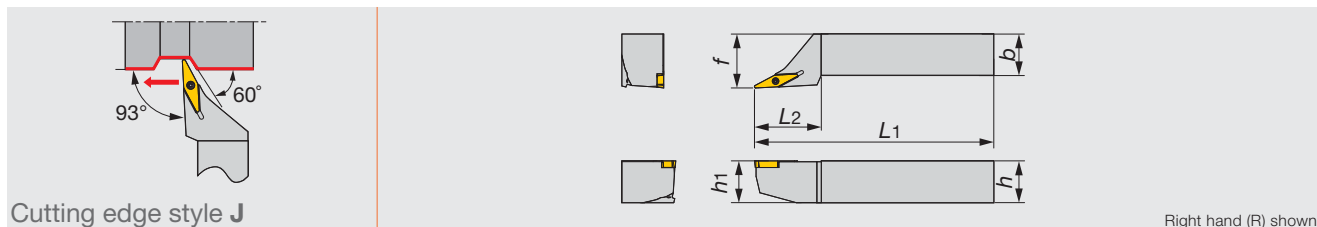

Inch	h	b	L1	L2	h1	f	rε**	Insert
SYJBR/L123	0.750	0.750	4.500	1.350	0.750	1.000	0.031	YWMT16T3...
SYJBR/L163	1.000	1.000	6.000	1.500	1.000	1.250	0.031	YWMT16T3...

Metric	h	b	L1	L2	h1	f	rε**	Insert
SYJBR/L2020K16	20	20	125	35	20	25	0.8	YWMT16T3...
SYJBR/L2525M16	25	25	150	40	25	32	0.8	YWMT16T3...

**re: Standard corner radius

SPARE PARTS



Designation	Clamping screw	Wrench
SYJBR/L...	CSTB-2.5L080	T-8F

Y-PRO SERIES

SYQBR/L

Screw-on clamp toolholder with 122.5° approach angle, for positive 25° rhombic inserts

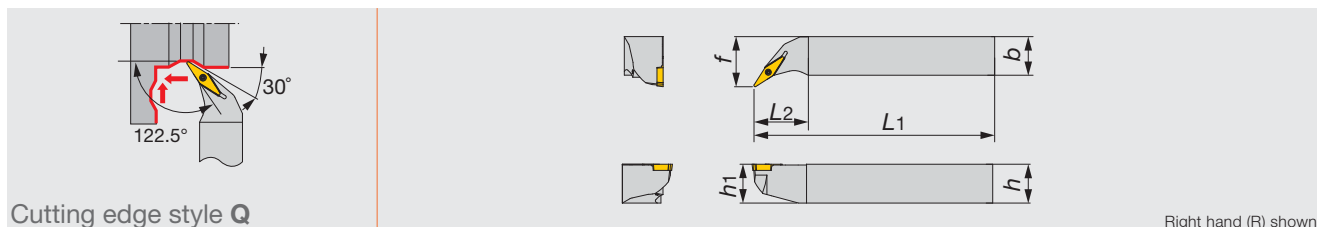

Inch	h	b	L1	L2	h1	f	rε**	Insert
SYQBR/L123	0.750	0.750	4.500	1.350	0.750	1.000	0.031	YWMT16T3...
SYQBR/L163	1.000	1.000	6.000	1.500	1.000	1.250	0.031	YWMT16T3...

Metric	h	b	L1	L2	h1	f	rε**	Insert
SYQBR/L2020K16	20	20	125	35	20	27	0.8	YWMT16T3...
SYQBR/L2525M16	25	25	150	35	25	32	0.8	YWMT16T3...

**re: Standard corner radius

SPARE PARTS



Designation	Clamping screw	Wrench
SYQBR/L...	CSTB-2.5L080	T-8F

Reference pages

SYJBR/L, SYQBR/L: Inserts → **B155**

**Y-PRO SERIES****SYHBR/L**

Screw-on clamp toolholder with 100° approach angle, for positive 25° rhombic inserts

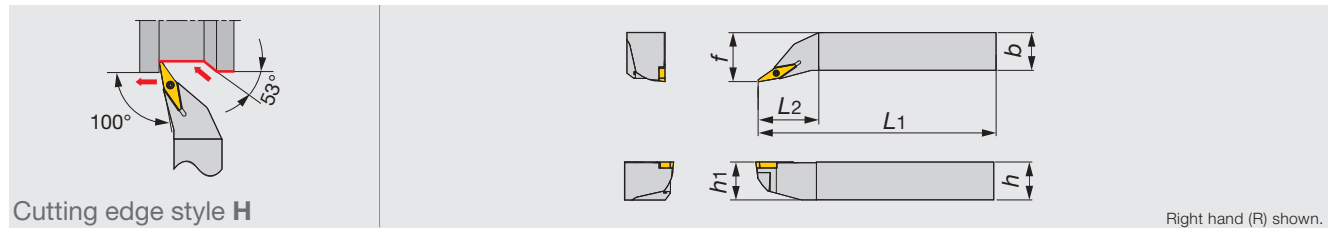

Cutting edge style H

Right hand (R) shown.

Inch	<i>h</i>	<i>b</i>	<i>L</i> ₁	<i>L</i> ₂	<i>h</i> ₁	<i>f</i>	<i>r</i> _ε **	Insert
SYHBR/L123	0.750	0.750	4.500	1.350	0.750	1.000	0.031	YWMT16T3...
SYHBR/L163	1.000	1.000	6.000	1.500	1.000	1.250	0.031	YWMT16T3...
Metric	<i>h</i>	<i>b</i>	<i>L</i> ₁	<i>L</i> ₂	<i>h</i> ₁	<i>f</i>	<i>r</i> _ε **	Insert
SYHBR/L2020K16	20	20	125	35	20	27	0.8	YWMT16T3...
SYHBR/L2525M16	25	25	150	40	25	32	0.8	YWMT16T3...

***r*_ε: Standard corner radius**SPARE PARTS**

Designation	Clamping screw	Wrench
SYHBR/L...	CSTB-2.5L080	T-8F

Y-PRO SERIES**SYIBN**

Screw-on clamp toolholder with 77.5° approach angle, for positive 25° rhombic inserts

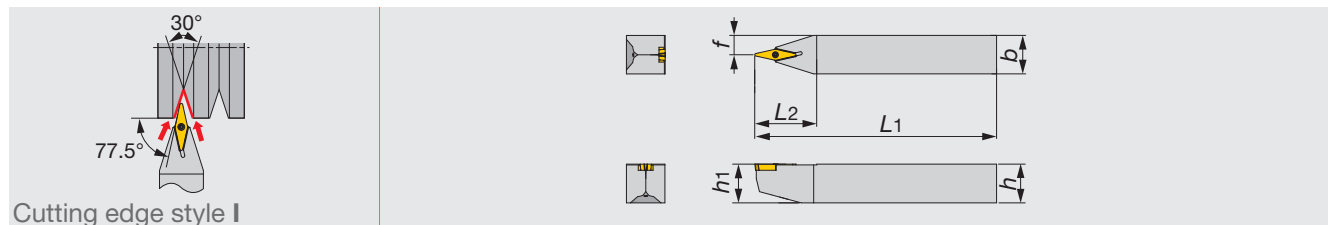

Cutting edge style I

Inch	<i>h</i>	<i>b</i>	<i>L</i> ₁	<i>L</i> ₂	<i>h</i> ₁	<i>f</i>	<i>r</i> _ε **	Insert
SYIBN123	0.750	0.750	4.500	1.250	0.750	0.375	0.031	YWMT16T3...
SYIBN163	1.000	1.000	6.000	1.500	1.000	0.500	0.031	YWMT16T3...
Metric	<i>h</i>	<i>b</i>	<i>L</i> ₁	<i>L</i> ₂	<i>h</i> ₁	<i>f</i>	<i>r</i> _ε **	Insert
SYIBN2020K16	20	20	125	32	20	10	0.8	YWMT16T3...
SYIBN2525M16	25	25	150	40	25	12.5	0.8	YWMT16T3...

***r*_ε: Standard corner radius**SPARE PARTS**

Designation	Clamping screw	Wrench
SYIBN...	CSTB-2.5L080	T-8F

Reference pages

SYHBR/L, SYIBN: Inserts → **B155**

**DCLNR/L**

"One-Double" toolholder with 95° approach angle, for negative 80° rhombic inserts

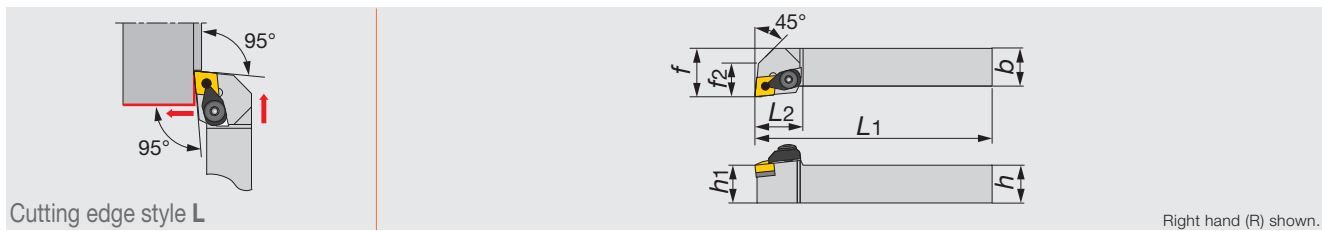

Metric	h	b	L1	L2	h1	f	f2	rε**	Insert
DCLNR/L2020K12	20	20	125	30	20	25	18	0.8	CN**1204...
DCLNR/L2525M12	25	25	150	30	25	32	18	0.8	CN**1204...
DCLNR/L3225P12	32	25	170	30	32	32	18	0.8	CN**1204...

Note: Except for 57-type chipbreaker inserts

**re: Standard corner radius

SPARE PARTS

Designation	Clamp	Lever	Piston	Clamp screw	Shim	Spring	Spring pin	Wrench 1	Wrench 2
DCLNR/L...	DCPM-43	DLCL43	DPIS43	DLCS43	LSC42	BP-10	LSP4	P-3	P-4

DWLNR/L

"One-Double" toolholder with 95° approach angle, for negative trigon inserts

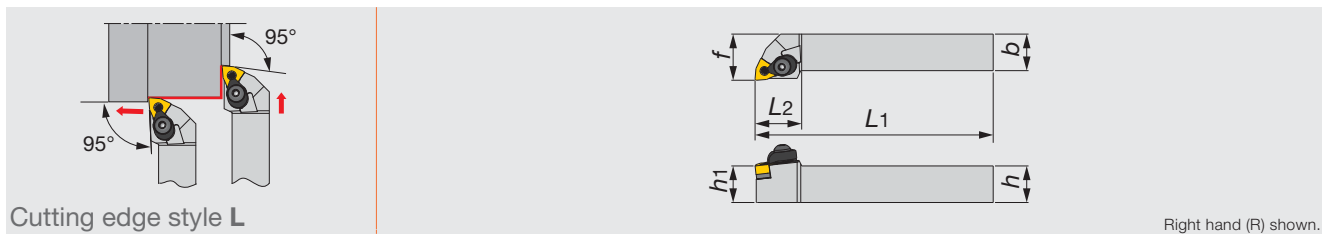

Metric	h	b	L1	L2	h1	f	rε**	Insert
DWLNR/L2020K06	20	20	125	25.5	20	25	0.8	WN**0604...
DWLNR/L2020K08	20	20	125	31	20	25	0.8	WN**0804...
DWLNR/L2525M06	25	25	150	26	25	32	0.8	WN**0604...
DWLNR/L2525M08	25	25	150	31	25	32	0.8	WN**0804...
DWLNR/L3225P08	32	25	170	30	32	32	0.8	WN**0804...

Note: Except for 57-type chipbreaker inserts

**re: Standard corner radius

SPARE PARTS

Designation	Clamp	Lever	Piston	Clamp screw	Shim	Spring	Spring pin	Wrench 1	Wrench 2
DWLNR/L**06	DCPM-33	LCL33	DPIS33	DLCS33	LSW312	BP-9	LSP3	P-2.5	P-3
DWLNR/L**08	DCPM-43	DLCL43	DPIS43	DLCS43	LSW42	BP-10	LSP4	P-3	P-4

Reference pages

DCLNR/L: Inserts → **B052** -, CBN → **B165** -, PCD → **B178**DWLNR/L: Inserts → **B097** -, CBN → **B167**

**DDJNR/L**

"One-Double" toolholder with 93° approach angle, for negative 55° rhombic inserts

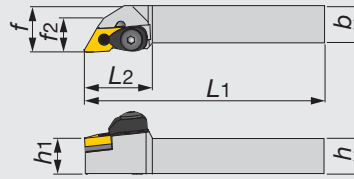
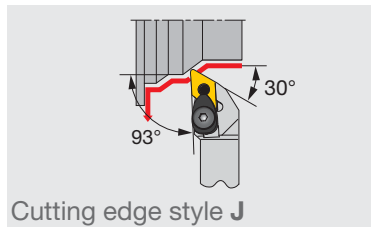

Right hand (R) shown.

Metric	<i>h</i>	<i>b</i>	<i>L</i> ₁	<i>L</i> ₂	<i>h</i> ₁	<i>f</i>	<i>f</i> ₂	<i>r</i> _ε **	Insert
DDJNR/L2020K15	20	20	125	38	20	25	19	0.8	DN**1504...
DDJNR/L2020K1506	20	20	125	38	20	25	19	0.8	DN**1506...
DDJNR/L2525M15	25	25	150	38	25	32	19	0.8	DN**1504...
DDJNR/L2525M1506	25	25	150	38	25	32	19	0.8	DN**1506...
DDJNR/L3225P15	32	25	170	38	32	32	19	0.8	DN**1504...
DDJNR/L3225P1506	32	25	170	38	32	32	19	0.8	DN**1506...

Note: Except for 57-type chipbreaker inserts

***r*_ε: Standard corner radius

SPARE PARTS									
Designation	Clamp	Lever	Piston	Clamp screw	Shim	Spring	Spring pin	Wrench 1	Wrench 2
DDJNR/L**15	DCPM-43	DLCL43	DPIS43	DLCS43	LSD42	BP-10	LSP4	P-3	P-4
DDJNR/L**1506	DCPM-43	DLCL43	DPIS44	DLCS43	LSD42	BP-10	LSP4	P-3	P-4

DTGNR/L

"One-Double" toolholder with 91° approach angle, for negative triangle inserts

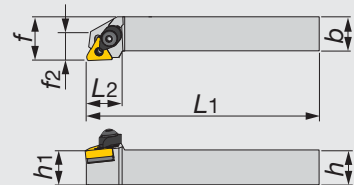
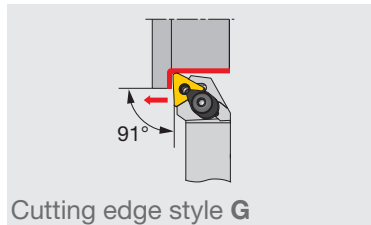

Right hand (R) shown.

Metric	<i>h</i>	<i>b</i>	<i>L</i> ₁	<i>L</i> ₂	<i>h</i> ₁	<i>f</i>	<i>f</i> ₂	<i>r</i> _ε **	Insert
DTGNR/L2020K16	20	20	125	21	20	25	16	0.8	TN**1604...
DTGNR/L2525M16	25	25	150	21	25	32	21	0.8	TN**1604...
DTGNR/L2525M22	25	25	150	28	25	32	25	0.8	TN**2204...

Note: Except for 57-type chipbreaker inserts

***r*_ε: Standard corner radius

SPARE PARTS									
Designation	Clamp	Lever	Piston	Clamp screw	Shim	Spring	Spring pin	Wrench 1	Wrench 2
DTGNR/L**16	DCPM-33	LCL33	DPIS33	DLCS33	LST317	BP-9	LSP3	P-2.5	P-3
DTGNR/L**22	DCPM-43	DLCL43	DPIS43	DLCS43	LST42	BP-10	LSP4	P-3	P-4

Reference pages

DDJNR/L: Inserts → **B063 -**, CBN → **B165 -**, PCD → **B178**DTGNR/L: Inserts → **B082 -**, CBN → **B166 -**, PCD → **B178**

**DSBNR/L**

"One-Double" toolholder with 75° approach angle, for negative square inserts

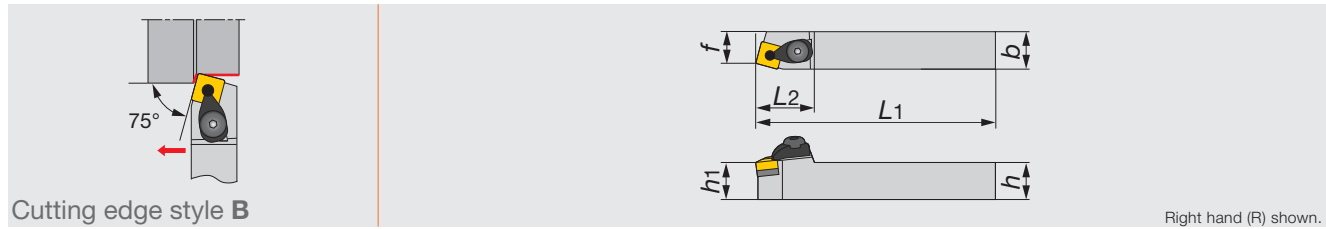

Cutting edge style B

Right hand (R) shown.

Metric	<i>h</i>	<i>b</i>	<i>L</i> ₁	<i>L</i> ₂	<i>h</i> ₁	<i>f</i>	<i>r</i> _ε **	Insert
DSBNR/L2020K12	20	20	125	35	20	17	0.8	SN**1204...
DSBNR/L2525M12	25	25	150	35	25	22	0.8	SN**1204...

Note: Except for 57-type chipbreaker inserts

***r*_ε: Standard corner radius**SPARE PARTS**

Designation	Clamp	Lever	Piston	Clamp screw	Shim	Spring	Spring pin	Wrench 1	Wrench 2
DSBNR/L...	DCPM-43	DLCL43	DPIS43	DLCS43	LSS42	BP-10	LSP4	P-3	P-4

DSDNN

"One-Double" toolholder with 45° approach angle, for negative square inserts

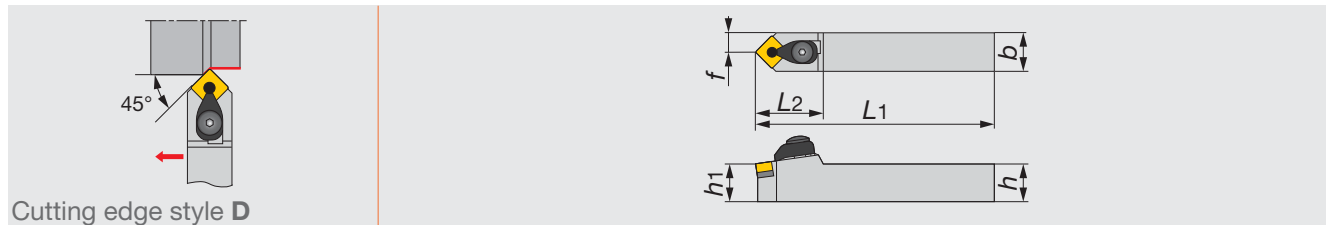

Cutting edge style D

Metric	<i>h</i>	<i>b</i>	<i>L</i> ₁	<i>L</i> ₂	<i>h</i> ₁	<i>f</i>	<i>r</i> _ε **	Insert
DSDNN2020K12	20	20	125	36	20	10	0.8	SN**1204...
DSDNN2525M12	25	25	150	36	25	12.5	0.8	SN**1204...

Note: Except for 57-type chipbreaker inserts

***r*_ε: Standard corner radius**SPARE PARTS**

Designation	Clamp	Lever	Piston	Clamp screw	Shim	Spring	Spring pin	Wrench 1	Wrench 2
DSDNN...	DCPM-43	DLCL43	DPIS43	DLCS43	LSS42	BP-10	LSP4	P-3	P-4

DSSNR/L

"One-Double" toolholder with 45° approach angle (S-style), for negative square inserts

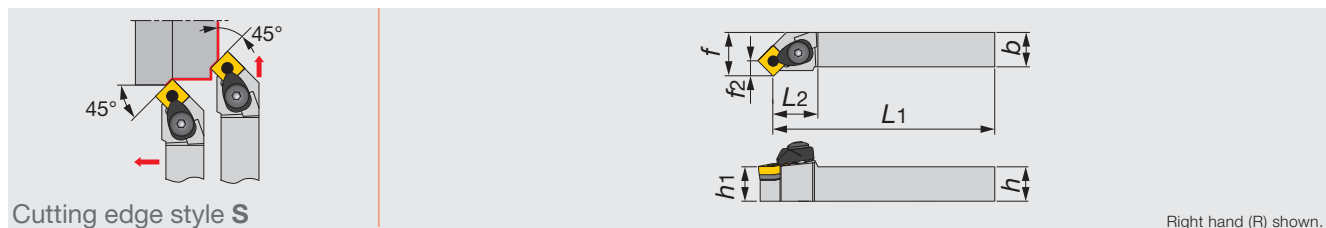

Cutting edge style S

Right hand (R) shown.

Metric	<i>h</i>	<i>b</i>	<i>L</i> ₁	<i>L</i> ₂	<i>h</i> ₁	<i>f</i>	<i>f</i> ₂	<i>r</i> _ε **	Insert
DSSNR/L2020K12	20	20	125	34.3	20	25	8.3	0.8	SN**1204...
DSSNR/L2525M12	25	25	150	34.3	25	32	8.3	0.8	SN**1204...

Note: Except for 57-type chipbreaker inserts

***r*_ε: Standard corner radius**SPARE PARTS**

Designation	Clamp	Lever	Piston	Clamp screw	Shim	Spring	Spring pin	Wrench 1	Wrench 2
DSSNR/L...	DCPM-43	DLCL43	DPIS43	DLCS43	LSS42	BP-10	LSP4	P-3	P-4

Reference pages

DSBNR/L, DSDNN, DSSNR/L: Inserts → **B073** -, CBN → **B166**, PCD → **B178**

**DSKNR/L**

"One-Double" toolholder with 75° approach angle, for negative square inserts

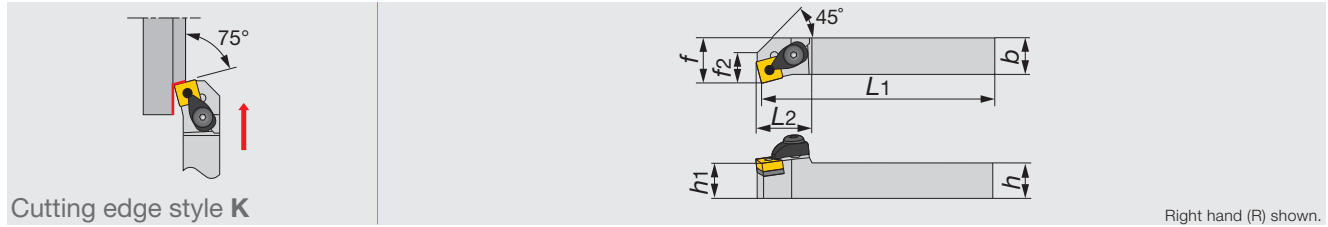

Metric	<i>h</i>	<i>b</i>	<i>L</i> ₁	<i>L</i> ₂	<i>h</i> ₁	<i>f</i>	<i>f</i> ₂	<i>r</i> _c **	Insert
DSKNR/L2020K12	20	20	125	31	20	25	17	0.8	SN**1204...
DSKNR/L2525M12	25	25	150	31	25	32	17	0.8	SN**1204...

Note: Except for 57-type chipbreaker inserts

***r*_c: Standard corner radius**SPARE PARTS**

Designation	Clamp	Lever	Piston	Clamp screw	Shim	Spring	Spring pin	Wrench 1	Wrench 2
DSKNR/L...	DCPM-43	DLCL43	DPIS43	DLCS43	LSS42	BP-10	LSP4	P-3	P-4

DTFNR/L

"One-Double" toolholder for facing with 91° approach angle, negative triangle inserts

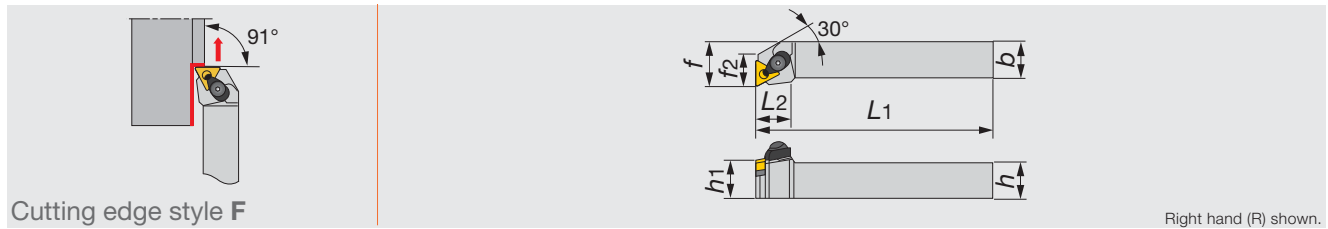

Metric	<i>h</i>	<i>b</i>	<i>L</i> ₁	<i>L</i> ₂	<i>h</i> ₁	<i>f</i>	<i>f</i> ₂	<i>r</i> _c **	Insert
DTFNR/L2020K16	20	20	125	23	20	25	18.5	0.8	TN**1604...
DTFNR/L2525M16	25	25	150	23	25	32	20	0.8	TN**1604...
DTFNR/L2525M22	25	25	150	31	25	32	24	0.8	TN**2204...

Note: Except for 57-type chipbreaker inserts

***r*_c: Standard corner radius**SPARE PARTS**

Designation	Clamp	Lever	Piston	Clamp screw	Shim	Spring	Spring pin	Wrench 1	Wrench 2
DTFNR/L**16	DCPM-33	LCL33	DPIS33	DLCS33	LST317	BP-9	LSP3	P-2.5	P-3
DTFNR/L**22	DCPM-43	DLCL43	DPIS43	DLCS43	LST42	BP-10	LSP4	P-3	P-4

Reference pages

DSKNR/L: Inserts → **B073 -**, CBN → **B166**, PCD → **B178**DTFNR/L: Inserts → **B082 -**, CBN → **B166**, PCD → **B178**

**DDQNR/L**

"One-Double" toolholder with 107.5° approach angle, for negative 55° rhombic inserts

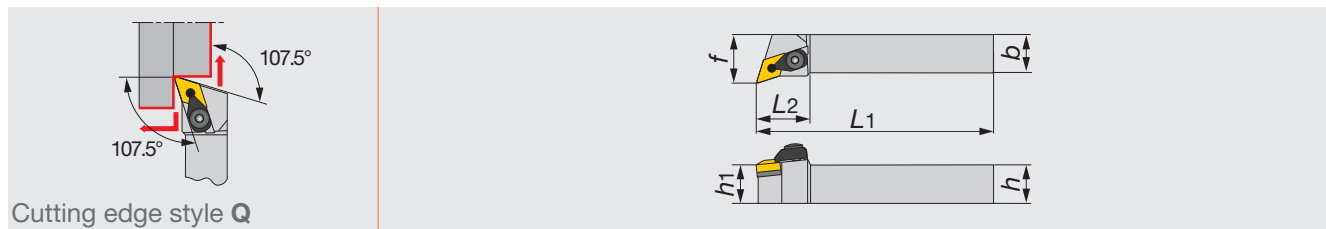

Metric	h	b	L1	L2	h1	f	re**	Insert
DDQNR/L2020K15	20	20	125	35	20	25	0.8	DN**1504...
DDQNR/L2020K1506	20	20	125	35	20	25	0.8	DN**1506...
DDQNR/L2525M15	25	25	150	35	25	32	0.8	DN**1504...
DDQNR/L2525M1506	25	25	150	35	25	32	0.8	DN**1506...
DDQNR/L3225P15	32	25	170	35	32	32	0.8	DN**1504...
DDQNR/L3225P1506	32	25	170	35	32	32	0.8	DN**1506...

Note: Except for 57-type chipbreaker inserts
 **re: Standard corner radius

SPARE PARTS									
Designation	Clamp	Lever	Piston	Clamp screw	Shim	Spring	Spring pin	Wrench 1	Wrench 2
DDQNR/L**15	DCPM-43	DLCL43	DPIS43	DLCS43	LSD42	BP-10	LSP4	P-3	P-4
DDQNR/L**1506	DCPM-43	DLCL43	DPIS44	DLCS43	LSD42	BP-10	LSP4	P-3	P-4

DRGNR/L

"One-Double" toolholder with 91° approach angle, for negative round inserts

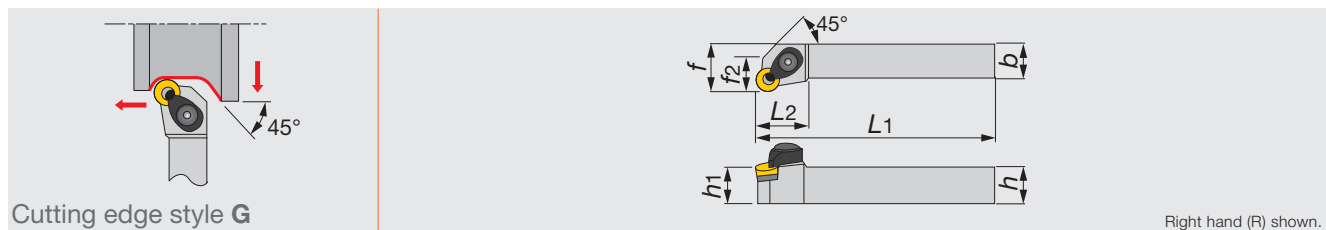

Metric	h	b	L1	L2	h1	f	f2	re**	Insert
DRGNR/L2525M12	25	25	150	28	25	32	18	6.35	RN**120400

**re: Standard corner radius

SPARE PARTS									
Designation	Clamp	Lever	Piston	Clamp screw	Shim	Spring	Spring pin	Wrench 1	Wrench 2
DRGNR/L...	DCPM-43	DLCL43	DPIS43	DLCS43	LSR42	BP-10	LSP4	P-3	P-4

Reference pages

DDQNR/L: Inserts → **B063** -, CBN → **B165** -, PCD → **B178**DRGNR/L: Inserts → **B072**

**PCLNR/L**

Lever lock type toolholder with 95° approach angle, for negative 80° rhombic inserts

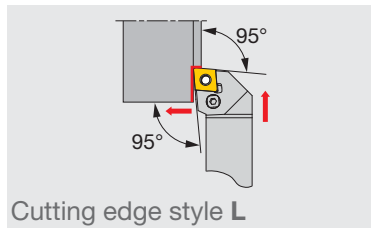

Cutting edge style L

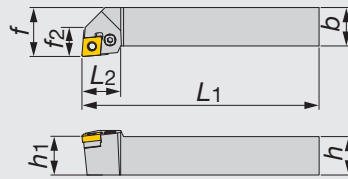

Right hand (R) shown.

Inch	<i>h</i>	<i>b</i>	<i>L</i> ₁	<i>L</i> ₂	<i>h</i> ₁	<i>f</i>	<i>f</i> ₂	<i>r</i> _ε **	Insert
PCLNR/L1233	0.750	0.750	4.500	0.813	0.750	1.000	0.625	0.031	CN*33...
PCLNR/L1633	1.000	1.000	6.000	0.813	1.000	1.250	1.250	0.031	CN*33...

Metric	<i>h</i>	<i>b</i>	<i>L</i> ₁	<i>L</i> ₂	<i>h</i> ₁	<i>f</i>	<i>f</i> ₂	<i>r</i> _ε **	Insert
PCLNR/L1616H09	16	16	100	20	16	20	15	0.8	CN**0903...
PCLNR/L2020K09	20	20	125	20	20	25	15	0.8	CN**0903...
PCLNR/L2525M09	25	25	150	20	25	32	15	0.8	CN**0903...
PCLNR/L1616	16	16	100	26	16	20	–	0.8	CN**1204...
PCLNR/L2020	20	20	125	28	20	25	18	0.8	CN**1204...
PCLNR/L2525M4	25	25	150	28	25	32	18	0.8	CN**1204...
PCLNR/L3225P4	32	25	170	28	32	32	18	0.8	CN**1204...
PCLNR/L3232	32	32	170	40	32	40	25	1.2	CN**1906...
PCLNR/L1616H12E	16	16	100	26	16	20	–	0.8	CN**1204...
PCLNR/L2020K12E	20	20	125	28	20	25	18	0.8	CN**1204...
PCLNR/L2525M12E	25	25	150	28	25	32	18	0.8	CN**1204...
PCLNR/L3225P12E	32	25	170	28	32	32	18	0.8	CN**1204...
PCLNR/L2525M16E	25	25	150	31	25	25	–	1.2	CN**1606...
PCLNR/L3225P16E	32	25	150	31	32	32	–	1.2	CN**1606...
PCLNR/L3232P16E	32	32	170	31	32	40	–	1.2	CN**1606...
PCLNR/L3232P19E	32	32	170	40	32	40	25	1.2	CN**1906...

**re: Standard corner radius

SPARE PARTS

Designation	Shim	Clamping screw	Wrench	Spring pin	Lever
PCLNR/L1233, 1633	LSC317	LCS3	P-2.5	LSP3	LCL33
PCLNR/L1616H09	ELSC32	LCS3	P-2.5	LSP3L	LCL33
PCLNR/L2020K09	ELSC32	LCS3	P-2.5	LSP3L	LCL33
PCLNR/L2525M09	ELSC32	LCS3	P-2.5	LSP3L	LCL33
PCLNR/L1616	LSC42	LCS4CA	P-3	LSP4	LCL4
PCLNR/L2020	LSC42	LCS4	P-3	LSP4	LCL4
PCLNR/L2525M4	LSC42	LCS4	P-3	LSP4	LCL4
PCLNR/L3225P4	LSC42	LCS4	P-3	LSP4	LCL4
PCLNR/L3232	LSC63	LCS6	P-4	LSP6	LCL6
PCLNR/L1616H12E	ELSC42	LCS4CA	P-3	LSP4	LCL4
PCLNR/L2020K12E	ELSC42	LCS4	P-3	LSP4S	LCL43M
PCLNR/L2525M12E	ELSC42	LCS4	P-3	LSP4S	LCL43M
PCLNR/L3225P12E	ELSC42	LCS4	P-3	LSP4S	LCL43M
PCLNR/L2525M16E	ELSC53	LCS5	P-3	LSP6C	LCL5
PCLNR/L3225P16E	ELSC53	LCS5	P-3	LSP6C	LCL5
PCLNR/L3232P16E	ELSC53	LCS5	P-3	LSP6C	LCL5
PCLNR/L3232P19E	ELSC63	LCS6	P-4	LSP6	LCL6

Reference pages

PCLNR/L: Inserts → B052 -, CBN → B165 -, PCD → B178 -



PTL2NR/L

No-offset Lever-lock clamp toolholder with 95° approach angle, for negative 60° triangular inserts

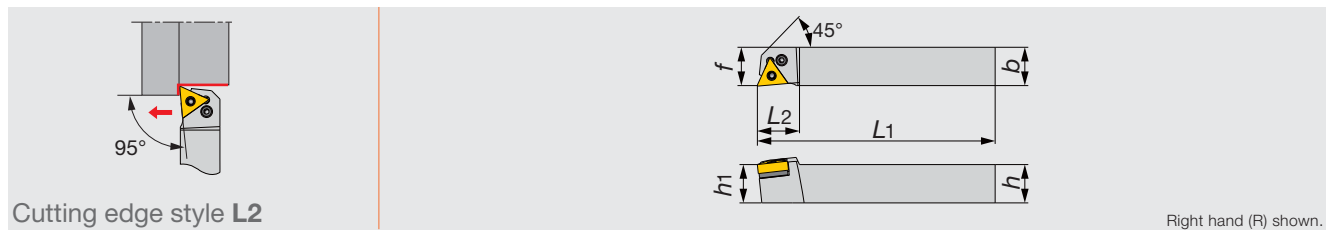

Metric	h	b	L1	L2	h1	f	r _ε **	Insert	Torque*
PTL2NR/L2020H16	20	20	100	22	20	20	0.4	TN**1604...	2

*Torque: Recommended torque (N-m) for clamping
 **re: Standard corner radius

SPARE PARTS

Designation	Shim	Clamping screw	Wrench	Spring pin	Lever
PTL2NR/L...	LST317 D30	LCS3	P-2.5	LSP3	LCL3

PDJNR/L

Lever lock type toolholder with 93° approach angle, for negative 55° rhombic inserts

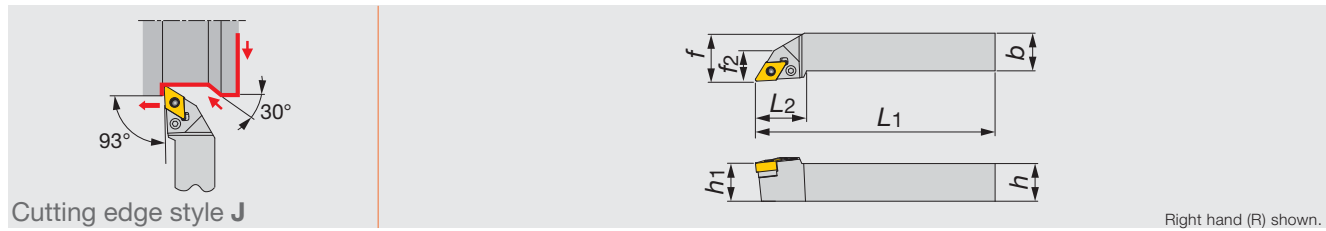

Inch	h	b	L1	L2	h1	f	f2	r _ε **	Insert
PDJNR/L1033	0.625	0.625	4.500	1.250	0.625	0.750	0.625	0.031	DN**33...
PDJNR/L1233	0.750	0.750	4.500	1.250	0.750	1.000	0.625	0.031	DN**33...
PDJNR/L1633	1.000	1.000	6.000	1.250	1.000	1.250	0.750	0.031	DN**33...

Metric	h	b	L1	L2	h1	f	f2	r _ε **	Insert
PDJNR/L1616H11	16	16	100	27	16	20	16	0.8	DN**1104...
PDJNR/L2020K11	20	20	125	27	20	25	16	0.8	DN**1104...
PDJNR/L2020	20	20	125	34	20	25	19	0.8	DN**1504...
PDJNR2020K15E	20	20	125	36	20	25	-	0.8	DN**1506...
PDJNR/L2520	25	20	150	34	25	25	19	0.8	DN**1504...
PDJNR/L2525M11	25	25	150	27	25	32	19	0.8	DN**1104...
PDJNR/L2525	25	25	150	34	25	32	19	0.8	DN**1504...
PDJNR/L2525M15E	25	25	150	36	25	32	-	0.8	DN**1506...
PDJNR/L3225	32	25	170	32	32	32	19	0.8	DN**1504...
PDJNR3225P15E	32	25	170	36	32	34	-	0.8	DN**1506...

**re: Standard corner radius

SPARE PARTS

Designation	Shim	Clamping screw	Wrench	Spring pin	Lever
PDJNR/L21033, 1023, 1633	ELSD32	LCS3	P-2.5	LSP3	LCL33
PDJNR/L1616H11, 2020K11	ELSD32	LCS3	P-2.5	LSP3	LCL33L
PDJNR/L2020	LSD42	LCS4	P-3	LSP4	LCL4
PDJNR2020K15E	ELSD42	ELCS4	P-3	LSP4S	LCL44
PDJNR/L2520	LSD42	LCS4	P-3	LSP4	LCL4
PDJNR/L2525	LSD42	LCS4	P-3	LSP4	LCL4
PDJNR/L2525M15E	ELSD42	ELCS4	P-3	LSP4S	LCL44
PDJNR/L3225	LSD42	LCS4	P-3	LSP4	LCL4
PDJNR3225P15E	ELSD42	ELCS4	P-3	LSP4S	LCL44

Reference pages

PTL2NR/L: Inserts → B082 -, CBN → B166, PCD → B178

PDJNR/L: Inserts → B063 -, CBN → B165 -, PCD → B178

PDPNN

Lever lock type toolholder with 62.5° approach angle, for negative 55° rhombic inserts

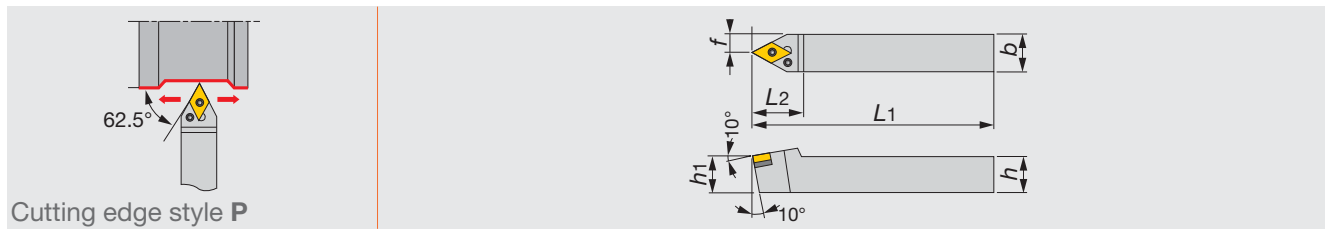

Metric	h	b	L1	L2	h1	f	re**	Insert
PDPNN2525	25	25	150	36	25	12.5	0.8	DN**1504...
PDPNN2525M15E	25	25	150	36	25	12.5	0.8	DN**1506...

**re: Standard corner radius

SPARE PARTS

Designation	Shim	Clamping screw	Wrench	Spring pin	Lever
PDPNN2525	LSD42	LCS4	P-3	LSP4	LCL4
PDPNN2525M15E	ELSD42	ELCS4	P-3	LSP4S	LCL44

PTGNR/L

Lever lock type toolholder with 91° approach angle, for negative triangle inserts

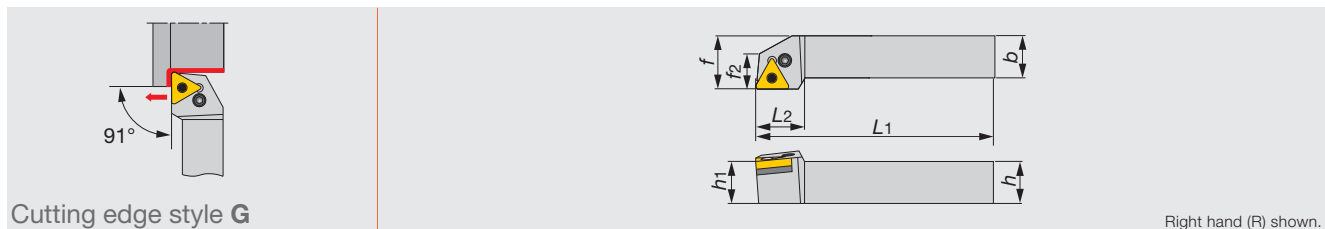

Inch	h	b	L1	L2	h1	f	f2	re**	Insert
PTGNR/L1223	0.750	0.750	4.500	0.750	0.750	1.000	0.625	0.031	TN**23...
PTGNR/L1623	1.000	1.000	6.000	0.750	1.000	1.250	0.875	0.031	TN**23...

Metric	h	b	L1	L2	h1	f	f2	re**	Insert
PTGNR/L1616	16	16	100	22	16	20	16	0.8	TN**1604...
PTGNR/L2020	20	20	125	22	20	25	16	0.8	TN**1604...
PTGNR/L2525M3	25	25	150	22	25	32	21	0.8	TN**1604...
PTGNR/L2525M4	25	25	150	28	25	32	24	0.8	TN**2204...
PTGNR3225P4	32	25	170	28	32	32	24	0.8	TN**2204...

**re: Standard corner radius

SPARE PARTS

Designation	Shim	Clamping screw	Wrench	Spring pin	Lever
PTGNR/L1223, 1623	-	LCS23A	P-2.5	-	LCL3
PTGNR/L1616, 2020	LST317	LCS3	P-2.5	LSP3	LCL3
PTGNR/L2525M3	LST317	LCS3	P-2.5	LSP3	LCL3
PTGNR/L2525M4	LST42	LCS4	P-3	LSP4	LCL4
PTGNR3225P4	LST42	LCS4	P-3	LSP4	LCL4

Reference pages

PDPNN: Inserts → **B063 -**, CBN → **B165 -**, PCD → **B178**

PTGNR/L: Inserts → **B082 -**, CBN → **B166 -**, PCD → **B178**

**PCBNR/L**

Lever lock type toolholder with 75° approach angle, for negative 80° rhombic inserts

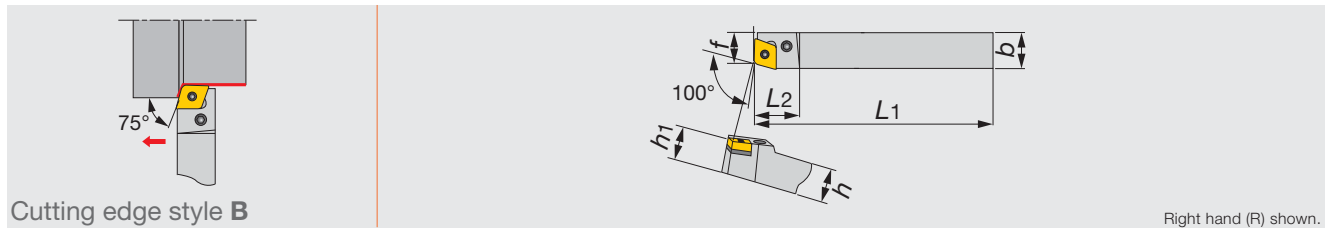

Cutting edge style B

Right hand (R) shown.

Metric	<i>h</i>	<i>b</i>	<i>L</i> ₁	<i>L</i> ₂	<i>h</i> ₁	<i>f</i>	<i>r</i> _ε **	Insert
PCBNR/L2525	25	25	150	28	25	22	0.8	CN**1204...

Note: 100° corners are used

**re: Standard corner radius

SPARE PARTS

Designation	Shim	Clamping screw	Wrench	Spring pin	Lever
PCBNR/L2525	LSC42	LCS4	P-3	LSP4	LCL4

PSBNR/L

Lever lock type toolholder with 75° approach angle, for negative square inserts

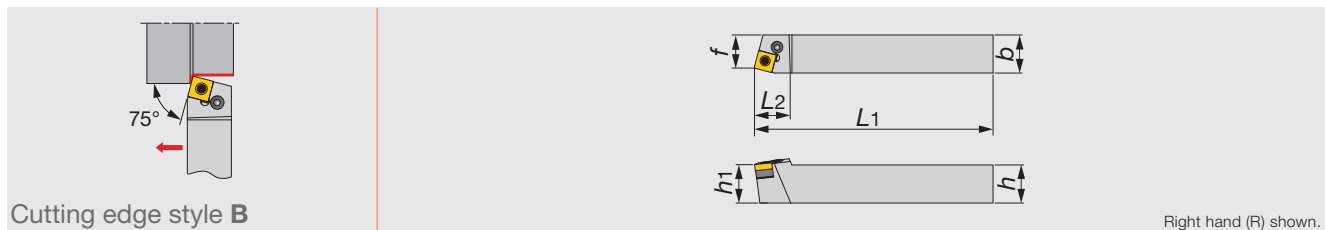

Cutting edge style B

Right hand (R) shown.

Metric	<i>h</i>	<i>b</i>	<i>L</i> ₁	<i>L</i> ₂	<i>h</i> ₁	<i>f</i>	<i>r</i> _ε **	Insert
PSBNR/L1616	16	16	100	22	16	13	0.8	SN**0903...
PSBNR/L2020	20	20	125	28	20	17	0.8	SN**1204...
PSBNR/L2525	25	25	150	24	25	22	0.8	SN**1204...
PSBNR/L3232	32	32	170	40	32	27	1.2	SN**1906...

**re: Standard corner radius

SPARE PARTS

Designation	Shim	Clamping screw	Wrench	Spring pin	Lever
PSBNR/L1616	LSS33	LCS3	P-2.5	LSP3L	LCL3
PSBNR/L2*2*	LSS42	LCS4	P-3	LSP4	LCL4
PSBNR/L3232	LSS63	LCS6	P-4	LSP6	LCL6

Reference pages

PCBNR/L: Inserts → **B052 -**, CBN → **B165 -**, PCD → **B178**PSBNR/L: Inserts → **B073 -**, CBN → **B166**, PCD → **B178**



PSDNN

Lever lock type toolholder with 45° approach angle, for negative square inserts

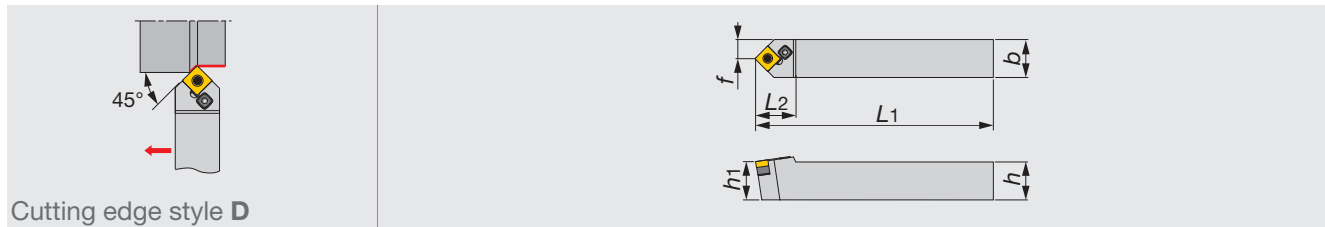

Cutting edge style D

Metric	<i>h</i>	<i>b</i>	<i>L</i> ₁	<i>L</i> ₂	<i>h</i> ₁	<i>f</i>	<i>r</i> _ε **	Insert
PSDNN1616	16	16	100	22	16	8	0.8	SN**0903...
PSDNN2020	20	20	125	30	20	10.3	0.8	SN**1204...
PSDNN2525	25	25	150	30	25	12.8	0.8	SN**1204...

***r*_ε: Standard corner radius

SPARE PARTS

Designation	Shim	Clamping screw	Wrench	Spring pin	Lever
PSDNN1616	LSS33	LCS3	P-2.5	LSP3L	LCL3
PSDNN2020	LSS42	LCS4	P-3	LSP4	LCL4
PSDNN2525	LSS42	LCS4	P-3	LSP4	LCL4

PSSNR/L

Lever lock type toolholder with 45° approach angle (S-style), for negative square inserts

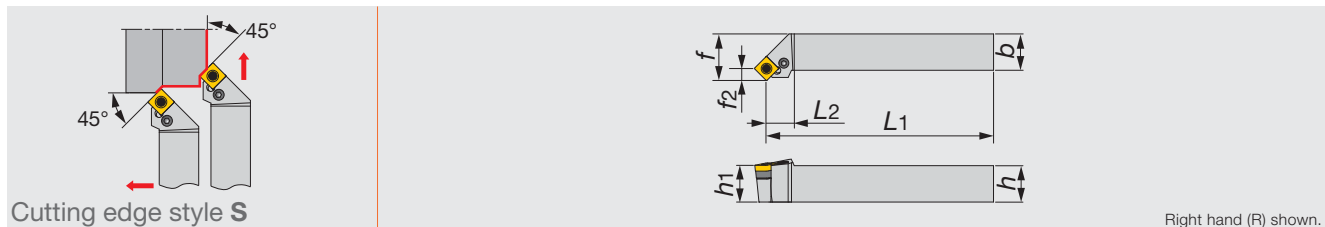

Cutting edge style S

Right hand (R) shown.

Metric	<i>h</i>	<i>b</i>	<i>L</i> ₁	<i>L</i> ₂	<i>h</i> ₁	<i>f</i>	<i>f</i> ₂	<i>r</i> _ε **	Insert
PSSNR/L1616	16	16	94	16	16	20	6.1	0.8	SN**0903...
PSSNR/L2020	20	20	116	21	20	25	8.3	0.8	SN**1204...
PSSNR/L2525	25	25	141	21	25	32	8.3	0.8	SN**1204...
PSSNR/L3225	32	25	161	21	32	32	8.3	0.8	SN**1204...
PSSNR/L3232	32	32	157.5	27.5	32	40	12.5	1.2	SN**1906...

***r*_ε: Standard corner radius

SPARE PARTS

Designation	Shim	Clamping screw	Wrench	Spring pin	Lever
PSSNR/L1616	LSS33	LCS3	P-2.5	LSP3L	LCL3
PSSNR/L2020	LSS42	LCS4	P-3	LSP4	LCL4
PSSNR/L**25	LSS42	LCS4	P-3	LSP4	LCL4
PSSNR/L3232	LSS63	LCS6	P-4	LSP6	LCL6

Reference pages

PSDNN, PSSNR/L: Inserts → B073 -, CBN → B166 -, PCD → B178 -



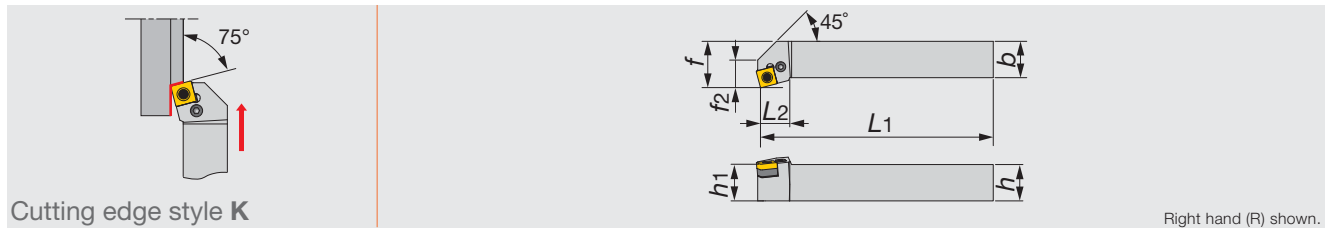

**PSKNR/L**

Lever lock type toolholder with 75° approach angle, for negative square inserts



Metric	<i>h</i>	<i>b</i>	<i>L</i> ₁	<i>L</i> ₂	<i>h</i> ₁	<i>f</i>	<i>f</i> ₂	<i>r</i> _ε **	Insert
PSKNR/L1616	16	16	100	17	16	25	15	0.8	SN**0903...
PSKNR/L2020	20	20	125	22	20	25	17	0.8	SN**1204...
PSKNR/L2525	25	25	150	22	25	32	17	0.8	SN**1204...
PSKNR3232	32	32	170	40	32	40	27	1.2	SN**1906...

**re: Standard corner radius

SPARE PARTS					
Designation	Shim	Clamping screw	Wrench	Spring pin	Lever
PSKNR/L1616	LSS33	LCS3	P-2.5	LSP3L	LCL3
PSKNR/L2*2*	LSS42	LCS4	P-3	LSP4	LCL4
PSKNR3232	LSS63	LCS6	P-4	LSP6	LCL6



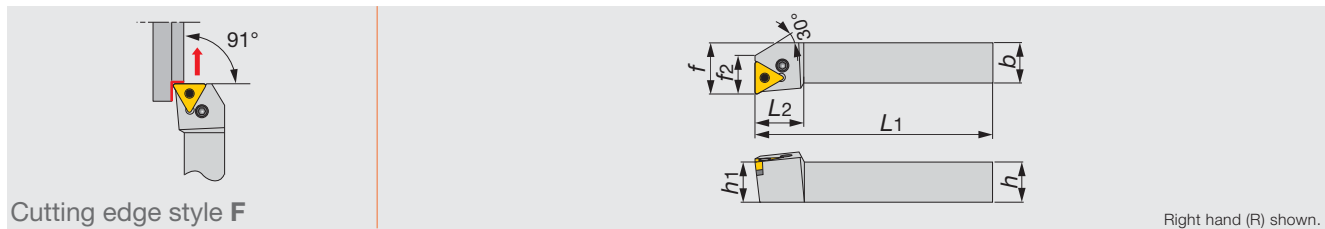

PTFNR/L

Lever lock type toolholder for facing with 91° approach angle, negative triangle inserts



Metric	<i>h</i>	<i>b</i>	<i>L</i> ₁	<i>L</i> ₂	<i>h</i> ₁	<i>f</i>	<i>f</i> ₂	<i>r</i> _ε **	Insert
PTFNR/L1616	16	16	100	22	16	20	16	0.8	TN**1604...
PTFNR/L2020	20	20	125	22	20	25	16	0.8	TN**1604...
PTFNR/L2525M3	25	25	150	22	25	32	20	0.8	TN**1604...
PTFNR/L2525M4	25	25	150	28	25	32	24	0.8	TN**2204...
PTFNR/L3225P4	32	25	170	28	32	32	24	0.8	TN**2204...

**re: Standard corner radius

SPARE PARTS					
Designation	Shim	Clamping screw	Wrench	Spring pin	Lever
PTFNR/L1616, 2020	LST317	LCS3	P-2.5	LSP3	LCL3
PTFNR/L2525M3	LST317	LCS3	P-2.5	LSP3	LCL3
PTFNR/L*25*4	LST42	LCS4	P-3	LSP4	LCL4

Reference pages

PSKNR/L: Inserts → **B073 -**, CBN → **B166**, PCD → **B178**PTFNR/L: Inserts → **B082 -**, CBN → **B166 -**, PCD → **B178**

PCFNR/L

Lever lock type toolholder for facing with 91° approach angle, negative 80° rhombic inserts

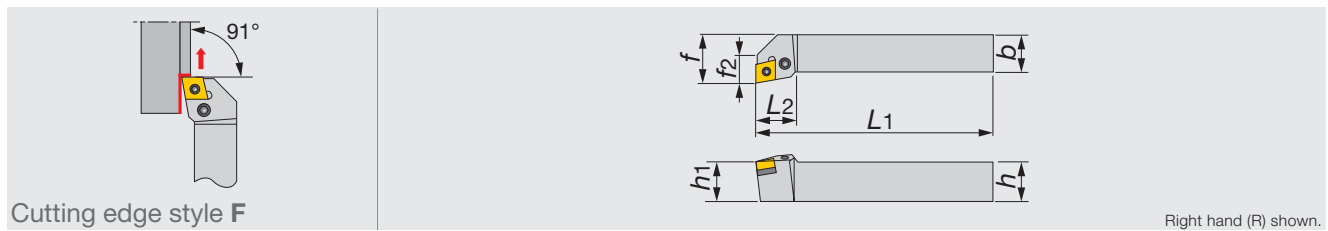

Metric	h	b	L1	L2	h1	f	f2	re**	Insert
PCFNR/L2020	20	20	125	28	20	25	18	0.8	CN**1204...
PCFNR/L2525	25	25	150	28	25	32	18	0.8	CN**1204...

**re: Standard corner radius

SPARE PARTS

Designation	Shim	Clamping screw	Wrench	Spring pin	Lever
PCFNR/L...	LSC42 D30	LCS4	P-3	LSP4	LCL4

PDQNR/L

Lever lock type toolholder with 107.5° approach angle, for negative 55° rhombic inserts

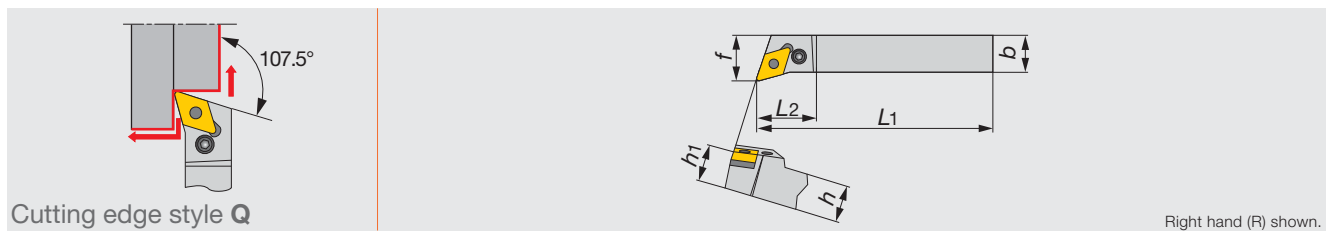

Metric	h	b	L1	L2	h1	f	re**	Insert
PDQNR/L2525	25	25	150	32	25	32	0.8	DN**1504...

**re: Standard corner radius

SPARE PARTS

Designation	Shim	Clamping screw	Wrench	Spring pin	Lever
PDQNR/L...	LSD42 D30	LCS4	P-3	LSP4	LCL4

PRGNR/L

Lever lock type toolholder with 91° approach angle, for negative round inserts

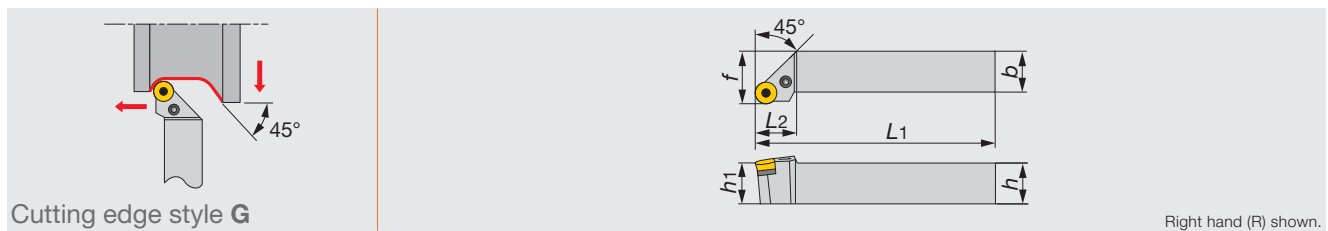

Metric	h	b	L1	L2	h1	f	re**	Insert
PRGNR/L2020	20	20	125	19	20	25	4.76	RNMG090300-61
PRGNR/L2525M4	25	25	150	25	25	32	6.35	RN**120400

**re: Standard corner radius

SPARE PARTS

Designation	Shim	Clamping screw	Wrench	Spring pin	Lever
PRGNR/L2020	LSR32	LCS3	P-2.5	LSP3	LCL3
PRGNR/L2525M4	LSR42	LCS4	P-3	LSP4	LCL4

Reference pages

PCFNR/L: Inserts → **B052 -**, CBN → **B165 -**, PCD → **B178 -**

PDQNR/L: Inserts → **B063 -**, CBN → **B165 -**, PCD → **B178**

PRGNR/L: Inserts → **B072**



PRGCR/L

Lever lock type toolholder with 91° approach angle, for positive round inserts

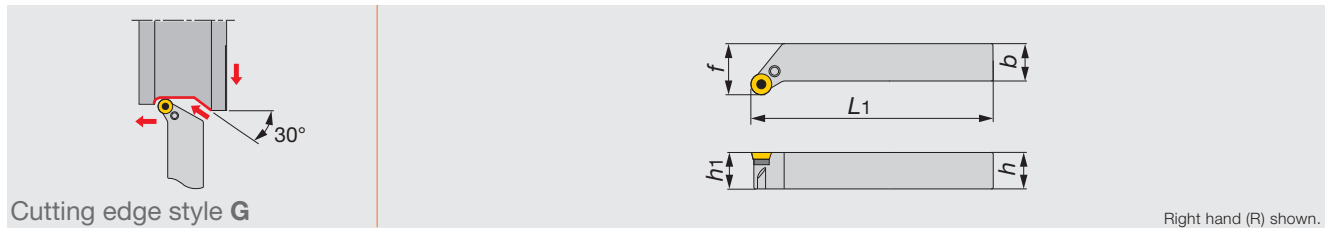

Metric	<i>h</i>	<i>b</i>	<i>L</i> ₁	<i>h</i> ₁	<i>f</i>	Insert
PRGCR/L2020K10	20	20	125	20	25	RCMM1003...
PRGCR/L2525M12	25	25	150	25	32	RCM*1204...
PRGCR/L3225P16	32	25	170	32	32	RCM*1606...
PRGCR/L3232P20	32	32	170	32	40	RCM*2006...

SPARE PARTS

Designation	Shim	Clamping screw	Wrench	Spring pin	Lever
PRGCR/L2020K10	LSR32C	LCS2	P-2	LSP3	LCL3C
PRGCR/L2525M12	LSR42C	LCS3	P-2.5	LSP3	LCL4C
PRGCR/L3225P16	LSR53C	LCS5	P-3	LSP4	LCL5C
PRGCR/L3232P20	LSR63C	LCS5	P-3	LSP6C	LCL6C

PRDCN

Lever lock type toolholder with 45° approach angle, for positive round inserts

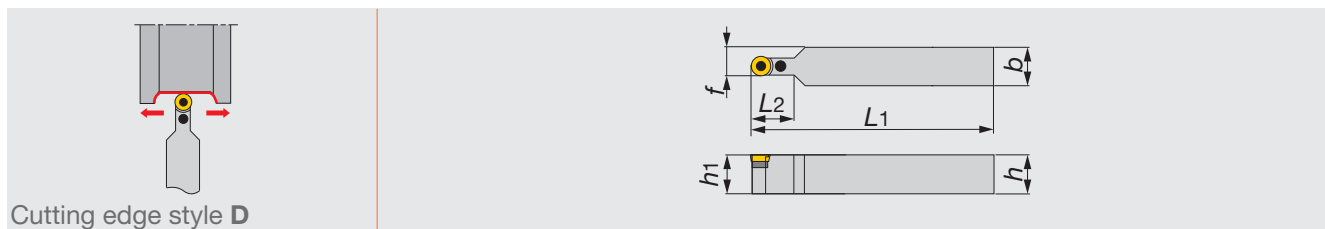

Metric	<i>h</i>	<i>b</i>	<i>L</i> ₁	<i>L</i> ₂	<i>h</i> ₁	<i>f</i>	Insert
PRDCN2020K10	20	20	125	22	20	15	RCMM1003...
PRDCN2525M12	25	25	150	24	25	18.5	RCM*1204...
PRDCN3225P12	32	25	170	24	32	18.5	RCM*1204...
PRDCN3225P16	32	25	170	28	32	20.5	RCM*1606...
PRDCN3232P20	32	32	170	32	32	26	RCM*2006...
PRDCN4040R25	40	40	200	42	40	32.5	RCM*2507...

SPARE PARTS

Designation	Shim	Clamping screw	Wrench	Spring pin	Lever
PRDCN2020K10	LSR32C	LCS2	P-2	LSP3	LCL3C
PRDCN**25*12	LSR42C	LCS3	P-2.5	LSP3	LCL4C
PRDCN3225P16	LSR53C	LCS5	P-3	LSP4	LCL5C
PRDCN3232P20	LSR63C	LCS5	P-3	LSP6C	LCL6C
PRDCN4040R25	LSR84C	LCS8C	P-4	LSP6	LCL8C

Reference pages

PRGCR/L, PRDCN: Inserts → **B126** -

**MCLNR/L**

Multi-clamp toolholder with 95° approach angle, for negative 80° rhombic inserts

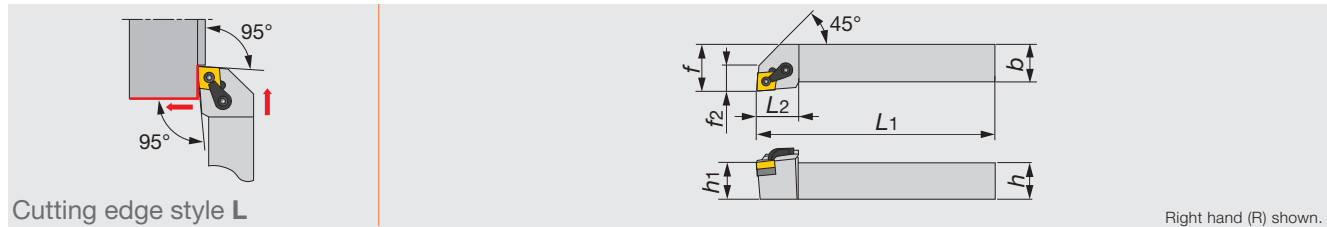

Cutting edge style L

Right hand (R) shown.

Inch	<i>h</i>	<i>b</i>	<i>L</i> ₁	<i>L</i> ₂	<i>h</i> ₁	<i>f</i>	<i>f</i> ₂	<i>r</i> ε**	Insert
MCLNR/L 124B	0.750	0.750	4.500	1.250	0.750	1.000	0.708	0.031	CN**43...
MCLNR/L 164D	1.000	1.000	6.000	1.250	1.000	1.250	0.708	0.031	CN**43...
MCLNR/L 204D	1.250	1.250	6.000	1.250	1.250	1.500	0.708	0.031	CN**43...
MCLNR/L 165D	1.000	1.000	6.000	1.250	1.000	1.250	0.866	0.047	CN**54...
MCLNR/L 205D	1.250	1.250	6.000	1.250	1.250	1.500	0.866	0.047	CN**54...
MCLNR/L 206D	1.250	1.250	6.000	1.250	1.250	1.500	1.180	0.047	CN**64...
MCLNR/L 246D	1.500	1.500	6.000	1.250	1.500	2.000	1.180	0.047	CN**64...
MCLNR/L 866D	1.500	1.000	6.000	1.500	1.500	1.250	1.500	0.063	CN**64...
Metric	<i>h</i>	<i>b</i>	<i>L</i> ₁	<i>L</i> ₂	<i>h</i> ₁	<i>f</i>	<i>f</i> ₂	<i>r</i> ε**	Insert
MCLNR/L2525M12	25	25	150	32	25	32	18	0.8	CN**1204...

**re: Standard corner radius

SPARE PARTS

Designation	Clamp	Pin	Right-left screw	Shim	Wrench 1	Wrench 2
MCLNR/L 124B, 164D, 204D	CK-20	KA54	STC20	ICSN433	P-3	P-2.5F
MCLNR/L 165D, 205D	CK-12	KL58	STC4	ICSN533	P-4	P-3
MCLNR/L 206D, 246D, 866D	CK-12	KL68	STC4	ICSN633	P-4	P-4
MCLNR/L2525M12	MCPM-21	MLP46	MCS625-3	MSC-432	P-3	P-2.5F

MWLNRL

Multi-clamp toolholder with 95° approach angle, for negative trigon inserts

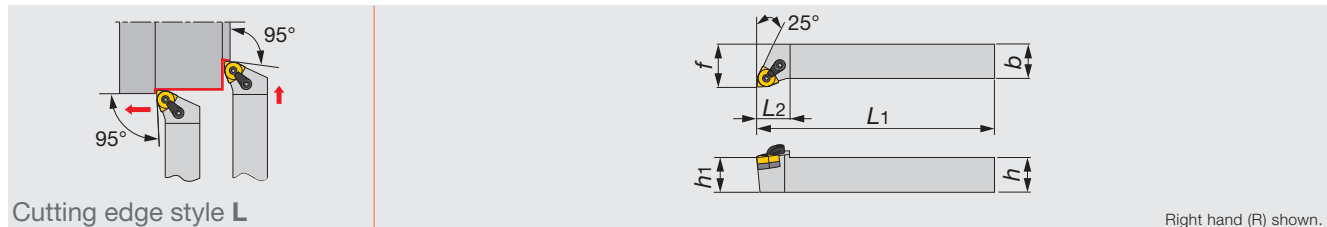

Cutting edge style L

Right hand (R) shown.

Inch	<i>h</i>	<i>b</i>	<i>L</i> ₁	<i>L</i> ₂	<i>h</i> ₁	<i>f</i>	<i>r</i> ε**	Insert
MWLNRL/L 124B	0.750	0.750	4.500	1.130	0.750	1.000	0.031	WN**43...
MWLNRL/L 164D	1.000	1.000	6.000	1.130	1.000	1.250	0.031	WN**43...
MWLNRL/L 205D	1.250	1.250	6.000	1.130	1.250	1.500	0.031	WN**54...
MWLNRL/L 205F	1.250	1.250	8.000	1.500	1.250	1.500	0.047	WN**54...
MWLNRL/L 245X	1.500	1.500	10.00	1.500	1.500	1.750	0.047	WN**54...
Metric	<i>h</i>	<i>b</i>	<i>L</i> ₁	<i>L</i> ₂	<i>h</i> ₁	<i>f</i>	<i>r</i> ε**	Insert
MWLNRL2020K08	20	20	125	25	20	25	0.8	WN**0804...
MWLNRL2525M08	25	25	150	25	25	32	0.8	WN**0804...

**re: Standard corner radius

SPARE PARTS

Designation	Clamp	Pin	Right-left screw	Shim	Wrench
MWLNRL/L 124B	CK-21	KL46	STC-20	P-2.5	P-2.5
MWLNRL/L 164D	CK-21	KL46	STC-4	P-2.5	P-2.5
MWLNRL/L 205D, 245D	CK-9	NL58	XNS-59	P-4	P-4
MWLNRL2020K08, MWLNRL2525M08	MCPM-6	MLP46	MCS520-2.5	MSW-432	P-2.5

Reference pages

MCLNR/L: Inserts → **B052 -**, CBN → **B165 -**, PCD → **B178**MWLNRL: Inserts → **B097 -**, CBN → **B167**



MVJNR/L

Multi-clamp toolholder with 93° approach angle, for negative 35° or 25° rhombic inserts

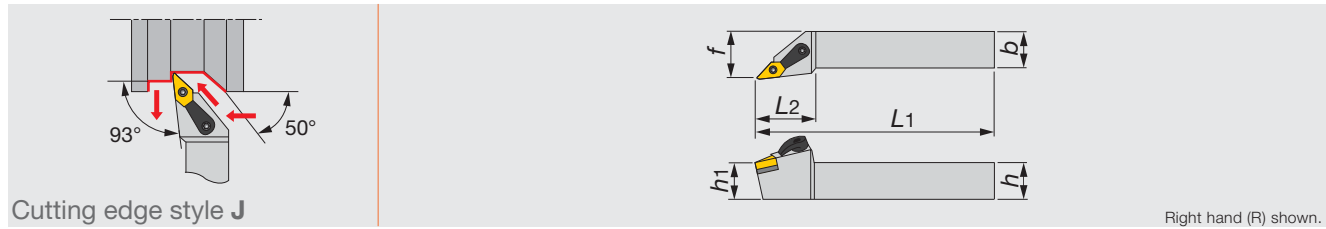

Right hand (R) shown.

Inch	<i>h</i>	<i>b</i>	<i>L</i> ₁	<i>L</i> ₂	<i>h</i> ₁	<i>f</i>	<i>r</i> _ε **	Insert
MVJNR/L 123B	0.750	0.750	4.500	1.500	0.750	1.000	0.031	V/YN**33...
MVJNR/L 163D	1.000	1.000	6.000	1.500	1.000	1.250	0.031	V/YN**33...
MVJNR/L 203D	1.250	1.250	6.000	1.500	1.250	1.500	0.031	V/YN**33...
Metric	<i>h</i>	<i>b</i>	<i>L</i> ₁	<i>L</i> ₂	<i>h</i> ₁	<i>f</i>	<i>r</i> _ε **	Insert
MVJNR/L2020K16	20	20	125	42	20	25	0.8	V/YN**1604...
MVJNR/L2525M16	25	25	150	42	25	32	0.8	V/YN**1604...
MVJNR/L3225P16	32	25	170	42	32	32	0.8	V/YN**1604...
MVJNR/L3232P16	32	32	170	42	32	40	0.8	V/YN**1604...

**re: Standard corner radius

SPARE PARTS

Designation	Clamp	Pin	Right-left screw	Shim	Wrench 1	Wrench 2
MVJNR/L 123B, 163D	CK-43	KL-34L	STC4	IVSN322	P-3	P-2F
MVJNR/L 203D	CK-43	KL-34L	STC4	IVSN322	P-4	P-2F
MVJNR/L**16	MCPM-22	MLP34L	MCS625-3	MSV-322	P-3	P-2F

MDJNR

Multi-clamp toolholder with 93° approach angle, for negative 55° rhombic inserts

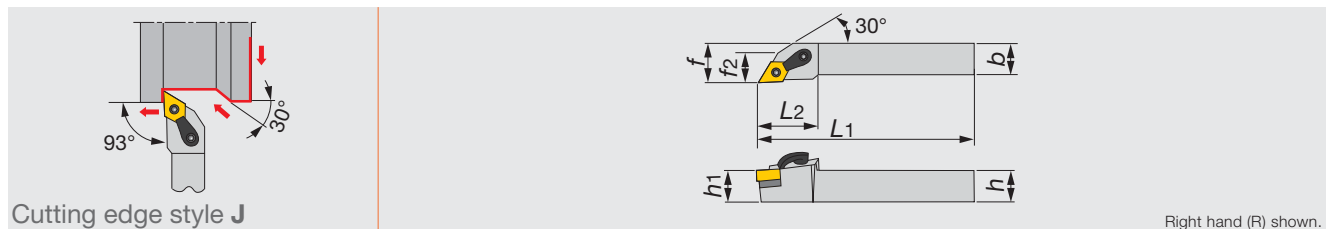

Right hand (R) shown.

Inch	<i>h</i>	<i>b</i>	<i>L</i> ₁	<i>L</i> ₂	<i>h</i> ₁	<i>f</i>	<i>f</i> ₂	<i>r</i> _ε **	Insert
MDJNR/L 124B	0.750	0.750	4.500	1.250	0.750	1.000	0.748	0.031	DN**43...
MDJNR/L 164D	1.000	1.000	6.000	1.250	1.000	1.250	0.748	0.031	DN**43...
MDJNR/L 204D	1.250	1.250	6.000	1.250	1.250	1.500	0.748	0.031	DN**43...
MDJNR/L 165D	1.000	1.000	6.000	1.500	1.000	1.250	0.866	0.047	DN**54...
MDJNR/L 205D	1.250	1.250	6.000	1.500	1.250	1.500	0.936	0.047	DN**54...
MDJNR/L 245D	1.500	1.500	6.000	1.500	1.500	2.000	0.936	0.047	DN**54...
Metric	<i>h</i>	<i>b</i>	<i>L</i> ₁	<i>L</i> ₂	<i>h</i> ₁	<i>f</i>	<i>f</i> ₂	<i>r</i> _ε **	Insert
MDJNR2525M15	25	25	150	38	25	32	19	0.8	DN**15...

**re: Standard corner radius

SPARE PARTS

Designation	Clamp	Pin	Right-left screw	Shim	Wrench 1	Wrench 2
MDJNR/L 124B, 164D, 204D	CK20	KL46L	STC20	IDSN433	P-3	P-2.5F
MDJNR/L 165D, 205D	CK12	KL58	STC4	IDSN533	P-4	P-2.5F
MDJNR2525M15	MCPM-22	MLP46L	MCS625-3	MSD-432	P-3	P-2.5F

Reference pages

MVJNR/L: Inserts → **B093 -**, **B104 -**, CBN → **B167 -**, PCD → **B178**

MDJNR: Inserts → **B063 -**, CBN → **B165 -**, PCD → **B178**

**MTJNR/LS**

Multi-clamp toolholder with 93° approach angle, for negative triangle inserts

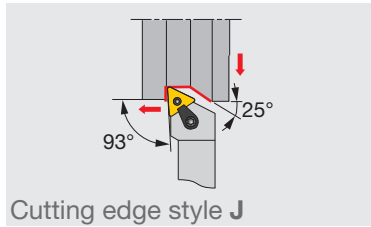

Cutting edge style J

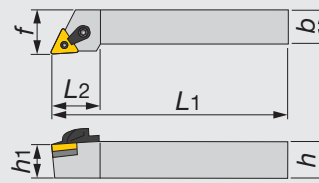

Right hand (R) shown.

Inch	<i>h</i>	<i>b</i>	<i>L</i> ₁	<i>L</i> ₂	<i>h</i> ₁	<i>f</i>	<i>r</i> ε**	Insert
MTJNR/LS 123	0.750	0.750	4.500	1.000	0.750	1.000	0.031	TN**33...
MTJNR/LS 163	1.000	1.000	6.000	1.000	1.000	1.250	0.031	TN**33...
MTJNR/LS 164	1.000	1.000	6.000	1.250	1.000	1.250	0.031	TN**43...
MTJNR/LS 204	1.250	1.250	6.000	1.250	1.250	1.500	0.031	TN**43...
MTJNR/LS 205	1.250	1.250	6.000	1.500	1.250	1.500	0.047	TN**54...

Metric	<i>h</i>	<i>b</i>	<i>L</i> ₁	<i>L</i> ₂	<i>h</i> ₁	<i>f</i>	<i>r</i> ε**	Insert
MTJNR2525M16	25	25	150	28	25	32	0.8	TN**16...

**r_ε: Standard corner radius

Designation	Clamp	Pin	Right-left screw	Shim	Wrench 1	Wrench 2
MTJNR/LS 123, 164	CK-6	KL34L	STC5	ITSN323	P-3	P-2F
MTJNR/LS 164, 204	CK-9	KL46	STC4	ITSN433	P-4	P-2.5F
MTJNR/LS 205	CK-9	KL58	STC4	ITSN534	P-4	P-3
MTJNR2525M16	MCPM-21	MLP34L	MCS625-3	MST-322	P-3	P-2F

MVVNN

Multi-clamp toolholder with 72.5° approach angle, for negative 35° or 25° rhombic inserts

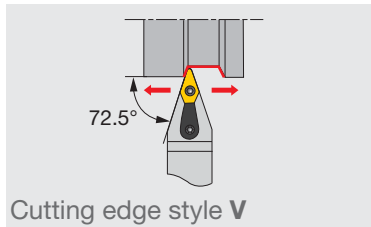

Cutting edge style V

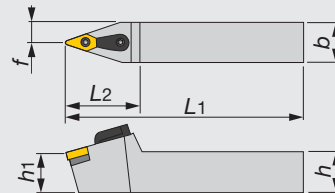

Inch	<i>h</i>	<i>b</i>	<i>L</i> ₁	<i>L</i> ₂	<i>h</i> ₁	<i>f</i>	<i>r</i> ε**	Insert
MVVNN 123B	0.750	0.750	4.000	1.810	0.750	0.375	0.031	VN**33...
MVVNN 163D	1.000	1.000	6.000	1.810	1.000	0.500	0.031	VN**33...

Metric	<i>h</i>	<i>b</i>	<i>L</i> ₁	<i>L</i> ₂	<i>h</i> ₁	<i>f</i>	<i>r</i> ε**	Insert
MVVNN2020K16	20	20	125	48	20	10	0.8	V/YN**1604...
MVVNN2525M16	25	25	150	48	25	12.5	0.8	V/YN**1604...
MVVNN3225P16	32	25	170	48	32	12.5	0.8	V/YN**1604...

**r_ε: Standard corner radius

Designation	Clamp	Pin	Right-left screw	Shim	Wrench 1	Wrench 2
MVVNN 123B, 163D	CK-43	KL34L	STC4	IVSN322	P-3	P-2F
MVVNN**16	MCPM-30	MLP34L	MCS828-4	MSV-322	P-4	P-2F

Reference pages

MTJNR: Inserts → **B082 -**, CBN → **B166 -**, PCD → **B178**MVVNN: Inserts → **B093 -**, **B104**, CBN → **B167 -**, PCD → **B178**



MDPNN

Multi-clamp toolholder with 62.5° approach angle, for negative 55° rhombic inserts

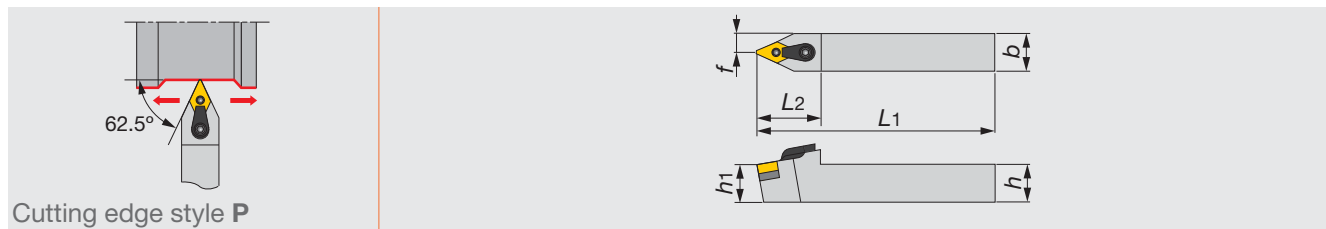

Cutting edge style P

Inch	h	b	L_1	L_2	h_1	f	r_{ϵ}^{**}	Insert
MDPNN164D	1.000	1.000	6.000	1.630	0.500	0.500	0.031	DN**43...

Metric	h	b	L_1	L_2	h_1	f	r_{ϵ}^{**}	Insert
MDPNN2525M15	25	25	150	42	25	12.5	0.8	DN**1504...

**re: Standard corner radius

SPARE PARTS

Designation	Clamp	Pin	Right-left screw	Shim	Wrench 1	Wrench 2
MDPNN164D	CK-20	KL46L	STC-20	INSN433	P-3	P-2.5F
MDPNN2525M15	MCPM-22	MLP46L	MCS625-3	MSD-432	P-3	P-2.5F

MTENNS

Multi-clamp toolholder with 60° approach angle, for negative triangle inserts

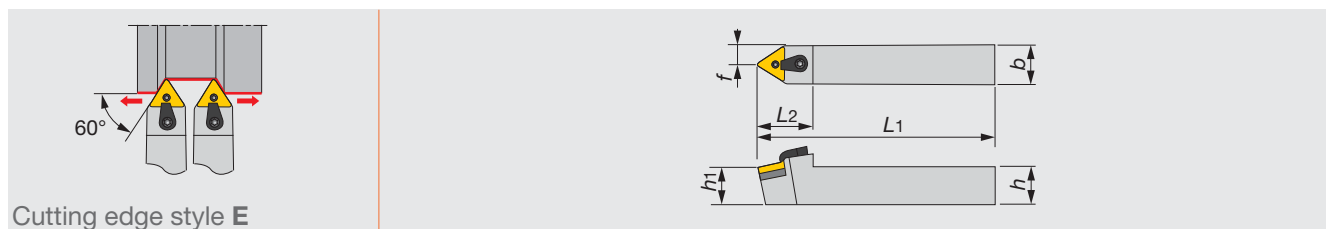

Cutting edge style E

Inch	h	b	L_1	L_2	h_1	f	r_{ϵ}^{**}	Insert
MTENNS 103	0.625	0.625	4.500	1.250	0.625	0.312	0.031	TN**32...
MTENNS 123	0.750	0.750	4.500	1.250	0.750	0.375	0.031	TN**32...
MTENNS 164	1.000	1.000	6.000	1.500	1.000	0.500	0.031	TN**43...
MTENNS 205	1.250	1.250	6.000	1.620	1.250	0.625	0.047	TN**54...

Metric	h	b	L_1	L_2	h_1	f	r_{ϵ}^{**}	Insert
MTENNS2525M16	25	25	150	35	25	12.5	0.8	TN**16...

**re: Standard corner radius

SPARE PARTS

Designation	Clamp	Pin	Right-left screw	Shim	Wrench 1	Wrench 2
MTENNS 103, 123	CK-6	KL34L	STC5	ITSN323	P-3	P-2F
MTENNS 164	CK-9	KL46	STC4	ITSN433	P-4	P-2.5F
MTENNS 205	CK-12	KL58L	STC4	ITSN534	P-4	P-3F
MTENNS2525M16	MCPM-21	MLP34L	MCS625-3	MST-322	P-3	P-2F

Reference pages

MDPNN: Inserts → B063 -, CBN → B165 -, PCD → B178

MTENN: Inserts → B082 -, CBN → B166 -, PCD → B178





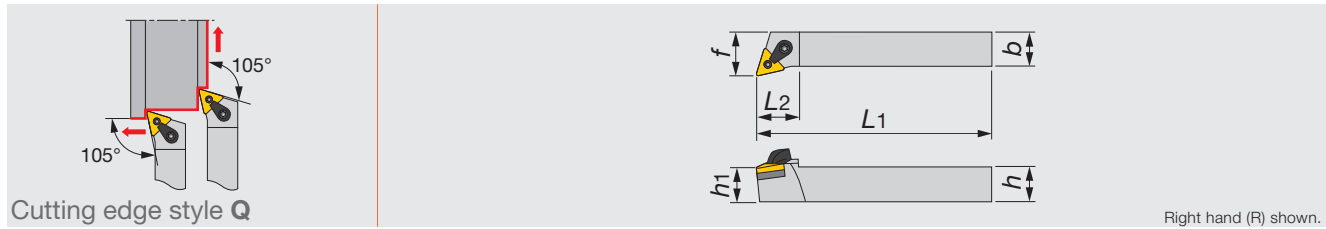

**MTQNR**

Multi-clamp toolholder with 105° approach angle, for negative triangle inserts



Metric	<i>h</i>	<i>b</i>	<i>L1</i>	<i>L2</i>	<i>h1</i>	<i>f</i>	<i>re</i> **	Insert
MTQNR2020K16	20	20	125	26	20	25	0.8	TN**16...
MTQNR2525M16	25	25	150	26	25	32	0.8	TN**16...

**re: Standard corner radius

SPARE PARTS						
Designation	Clamp	Pin	Right-left screw	Shim	Wrench 1	Wrench 2
MTQNR...	MCPM-21	MLP34L	MCS625-3	MST-322	P-3	P-2F





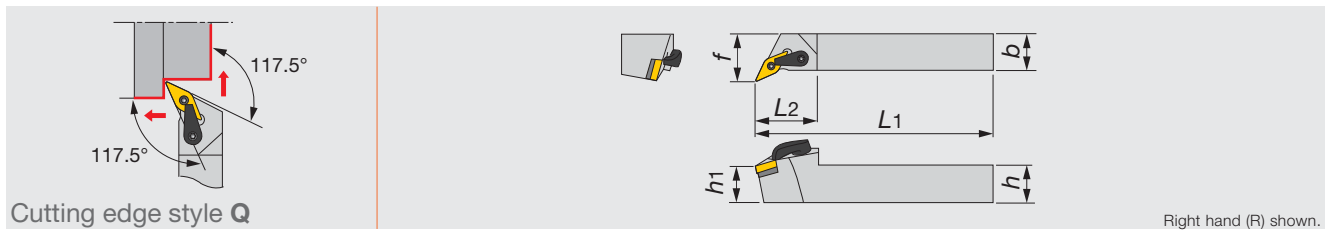

MVQNR/L

Multi-clamp toolholder with 117.5° approach angle, for negative 35° or 25° rhombic inserts



Metric	<i>h</i>	<i>b</i>	<i>L1</i>	<i>L2</i>	<i>h1</i>	<i>f</i>	<i>re</i> **	Insert
MVQNR/L2020K16	20	20	125	40	20	25	0.8	V/YN**1604...
MVQNR/L2525M16	25	25	150	40	25	32	0.8	V/YN**1604...
MVQNR/L3232P16	32	32	170	40	32	40	0.8	V/YN**1604...

**re: Standard corner radius





























SPARE PARTS						
Designation	Clamp	Pin	Right-left screw	Shim	Wrench 1	Wrench 2
MVQNR/L...	MCPM-22	MLP34L	MCS625-3	MSV-322	P-3	P-2F

Reference pages

MTQNR: Inserts → **B082 -**, CBN → **B166 -**, PCD → **B178**MVQNR/L: Inserts → **B93 -**, **B104**, CBN → **B167 -**, PCD → **B178**

Replacement Parts for M-type Toolholders

- When using the inserts shown in the shaded cells, the optional parts shown in the shaded cells are needed. You may purchase them separately.
- 1) Used for 1616H16. • 2) Used for MSDNN. • 3) Used for MDJNR/L • 4) Used for MVVNN

Toolholders Designation		Applicable inserts		Shim	Lock pin	Shim screw	Clamp	Clamping screw	Chipbreaker piece	Lock pin Wrench	Wrench
		Designation	Shape								
MSDNN MSSNR/L	103 123	SN□□32□□		ISSN 322	KL34	–	CK-6	STC5	CBS-4M	P-2.5F	P-3
		SN□□32□□			–	KAS3			CBS-4MN ²⁾		
	124 164	SN□□43□□		ISSN 433	–	KAS4	CK-9	STC4	CBS-4M	P-2.5F	P-3
		SN□□43□□		ISSN 433	KL46	–			CBS-4MN ²⁾		
MTGNR/L MTJNR/L MTENN	103 123 163	TN□□33□□		ITSN 323	KL34L	–	CK-6 ¹⁾	STC5 ¹⁾	CBT-3M	P-2F	P-3
		TN□□33□□			–	KAS3					
		TN□□32□□		ITSN 333	KL34L	–	CK-6 ²⁾	STC5 ²⁾	CBT-3M	P-2F	P-3
		TN□□32□□			–	KAS3					
	164 204	TN□□43□□		ITSN 433	–	KAS4	CK-9	STC4	CBT-3M	(P-2F)	P-3
	2525M22 3225P22 3232P22	TN□□43□□		ITSN 433	KL46	–	CK-9	STC4	CBT-4M	P-2.5F	P-4
		TN□□43□□			–	KAS4					
	205	TN□□54□□		ITSN 534	KL58	KAS5	CK-9	STC4	–	P-3	P-4
	246	TN□□66□□		ITSN 636	KL68L	KAS6	CK-12	STC4	–	P-3	P-4
MCLNR/L	124 164 204	CN□□43□□		ICSN 433	–	KAS4	CK-20	STC20	CBC-4MN	P-2.5F	P-3
		CN□□43□□			KL46L						
	165 205	CN□□54□□		ICSN 533	KL58	–	CK-12	STC4	–	P-3	P-4
	206 246	CN□□64□□		ICSN 633	KL68	–	CK-12	STC4	–	P-4	P-4
MDJNR/L MDPNN	124 164 204	DN□□44□□		IDSN 433	–	–	CK-20	STC20	CBD-4MR/L CBD-4MN	P-2.5F	P-3
		DN□□43□□			IDSN 443						
		DN□□43□□		IDSN 443	–	KAS54					
		DN□□44□□		IDSN 433	–	KAS54	CK-20	STC20 CBD-4MN	CBD-4MR/L ³⁾	P-2.5F	P-3



Ext. Toolholder



Replacement Parts for M-type Toolholders

Toolholders Designation	Applicable inserts		Shim	Lock pin	Shim screw	Clamp	Clamping screw	Chipbreaker piece	Lock pin Wrench	Wrench
	Designation	Shape								
MVJNR/L 123 MNVNN 163 MVQNR/L 203	VN□□33□□		IVSN322	KL34L	KAS3	CK-43 ⁴⁾	STC4 ⁴⁾	—	P-2F	P-3 P-4 ⁴⁾
MRGNR/L 124B 164D	RN□□43□□		IRSN-43	KL46	—	CK-21	STC20 STC4	CBR-4MN	P-2.5F	P-3
	RN□□43□□			—	KAS4					
	RN□□45□□		IRSN-42	—	KAS4	CK-21	STC20 STC4	CBR-4MN	P-2.5F	P-3
MWLNR/L 124 164	WN□□43□□		IWSN-433	KL46	—	CK-21	STC20 STC4	—	P-2.5	P-2.5
	205		WN□□53□□	IWSN-533	NL58	—	CK-9	XNS-59	—	P-4

Note : The shims are made of Tungaloy grade D30, and the chipbreaker pieces are of TX30.

List of Chipbreaker Pieces

In addition to the standard chipbreaker pieces, optional chipbreaker pieces are available separately. Select the proper one that is suitable for your cutting conditions.

Shape	Designation	Inserts	Dimensions (in)		Chipbreaker width when assembled (in)
			A	T	
	CBS-4S	SN□□43□□	0.457	0.098	0.059
	CBS-4M	SN□□45□□	0.417		0.098
	CBS-4L		0.358		0.157
	CBS-4SN	SN□□43□□	0.453	0.098	0.059
	CBS-4MN	SN□□45□□	0.413		0.098
	CBS-4LN		0.354		0.157
	CBT-3S	TN□□33□□	0.476	0.098	0.059
	CBT-3M	TN□□35□□	0.437		0.098
	CBT-3L		0.398		0.138
	CBT-4S	TN□□43□□	0.665	0.098	0.059
	CBT-4M		0.626		0.098
	CBT-4L		0.567		0.138
	CBC-4SN	CN□□43□□	0.453	0.098	0.059
	CBC-4MN	CN□□45□□	0.413		0.098
	CBC-4LN		0.374		0.138
	CBD-4SR/L	DN□□43□□	0.453	0.098	0.059
	CBD-4MR/L	DN□□44□□	0.413		0.098
	CBD-4LR/L		0.374		0.138
	CBD-4SN	DN□□44□□	0.453	0.098	0.059
	CBD-4MN		0.413		0.098
	CBD-4LN		0.374		0.138
	CBR-4SN	RN□□43□□	0.469	0.098	0.059
	CBR-4MN	RN□□44□□	0.429		0.098



ETANR

Pin lock toolholder with 91° approach angle, for negative triangle inserts

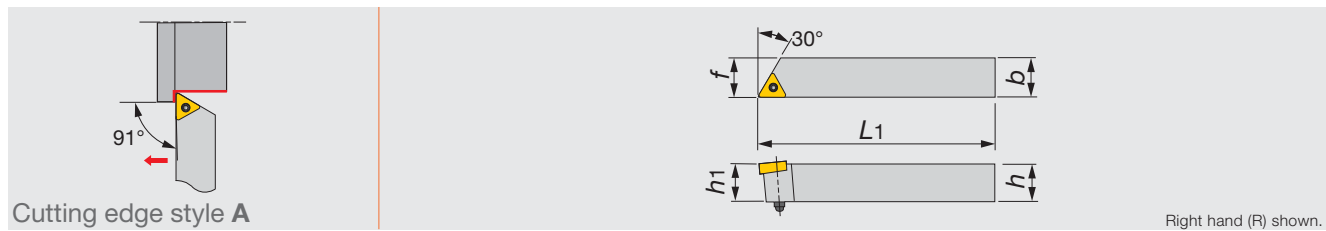

Metric	<i>h</i>	<i>b</i>	<i>L</i> ₁	<i>h</i> ₁	<i>f</i>	<i>r</i> _ε **	Insert
ETANR1616H33	16	16	100	15.5	16	0.8	TN**1604...
ETANR2020K33	20	20	125	19.5	20	0.8	TN**1604...

***r*_ε: Standard corner radius

SPARE PARTS



Designation	E-ring	Pin	Wrench
ETANR1616H33	ER3	P332US	KY40
ETANR2020K33	ER3	P333US	KY40

ETGNR/L

Pin lock toolholder with 91° approach angle, for negative triangle inserts

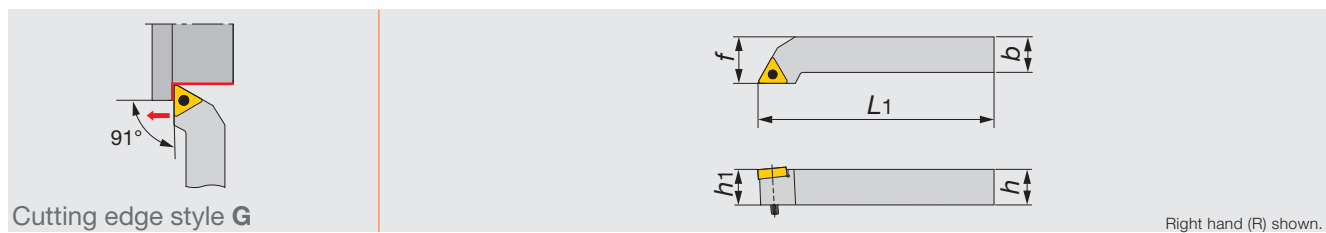

Metric	<i>h</i>	<i>b</i>	<i>L</i> ₁	<i>h</i> ₁	<i>f</i>	<i>r</i> _ε **	Insert
ETGNR/L1212	12	12	80	11.5	16	0.4	TN**1103...
ETGNR/L1616H33	16	16	100	15.5	20	0.8	TN**1604...
ETGNR/L2020K33	20	20	125	19.5	25	0.8	TN**1604...
ETGNR/L2020K33W	20	20	125	19.5	25	0.8	TN**1604...
ETGNR2525M33	25	25	150	24.5	32	0.8	TN**1604...
ETGNR/L2525M33W	25	25	150	24.5	32	0.8	TN**1604...

***r*_ε: Standard corner radius

SPARE PARTS



Designation	E-ring	Pin	Shim	Wrench
ETGNR/L1212	ER2	P221US	-	KY25
ETGNR/L1616H33	ER3	P332US	-	KY40
ETGNR/L2020K33	ER3	P333US	-	KY40
ETGNR/L2020K33W	ER3	P333WS	EST32	KY40
ETGNR2525M33	ER3	P334US	-	KY40
ETGNR/L2525M33W	ER3	P334WS	EST32	KY40

Reference pages

ETANR, ETGNR/L: Inserts → B082 -, CBN → B166 -, PCD → B178

**ETENN**

Pin lock toolholder with 60° approach angle, for negative triangle inserts

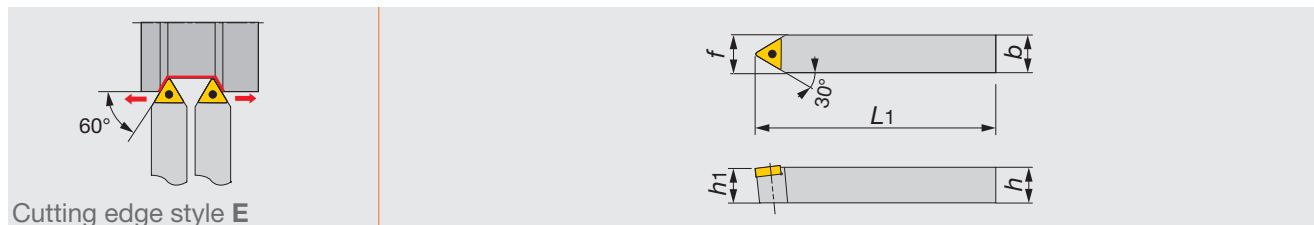

Metric	<i>h</i>	<i>b</i>	<i>L</i> ₁	<i>h</i> ₁	<i>f</i>	<i>r</i> _ε **	Insert
ETENN1212	12	12	80	11.5	6	0.4	TN**1103...
ETENN1616H33	16	16	100	15.5	8	0.8	TN**1604...
ETENN2020K33	20	20	125	19.5	10	0.8	TN**1604...
ETENN2020K33W	20	20	125	19.5	10	0.8	TN**1604...
ETENN2525M33W	25	25	150	24.5	12.5	0.8	TN**1604...

**re: Standard corner radius

SPARE PARTS

Designation	E-ring	Pin	Shim	Wrench
ETENN1212	ER2	P221US	-	KY25
ETENN1616H33	ER3	P332US	-	KY40
ETENN2020K33	ER3	P333US	-	KY40
ETENN2020K33W	ER3	P333WS	EST32	KY40
ETENN2525M33W	ER3	P334WS	EST32	KY40

ESDNR/L

Pin lock toolholder with 45° approach angle, for negative square inserts

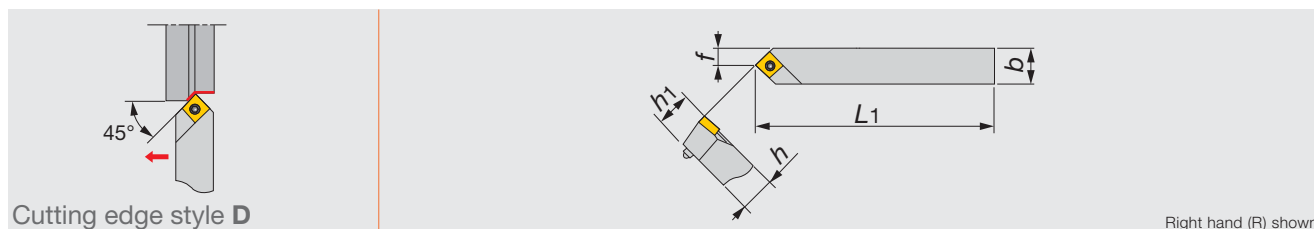

Right hand (R) shown.

Metric	<i>h</i>	<i>b</i>	<i>L</i> ₁	<i>h</i> ₁	<i>f</i>	<i>r</i> _ε **	Insert
ESDNR1212	12	12	80	11.5	6	0.8	SN**0903...
ESDNR1616H32	16	16	100	15.5	8	0.8	SN**0903...

**re: Standard corner radius

SPARE PARTS

Designation	E-ring	Pin	Wrench
ESDNR1212	ER3	P321US	KY40
ESDNR1616H32	ER3	P322US	KY40

Reference pages

ETENN: Inserts → **B082** -, CBN → **B166** -, PCD → **B178**ESDNR/L: Inserts → **B073** -



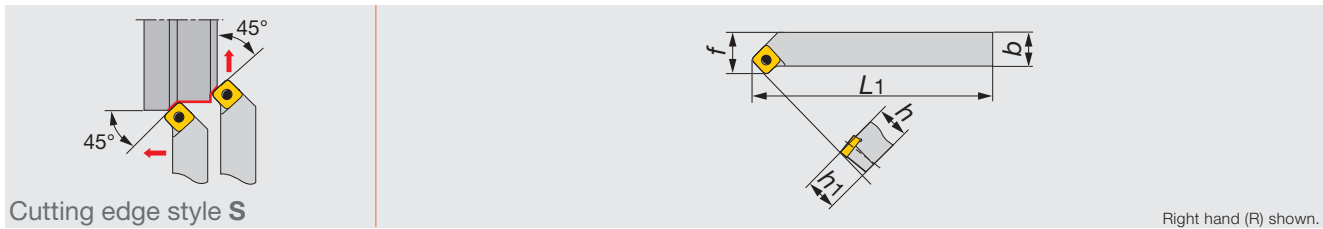

**ESSNR/L**

Pin lock toolholder with 45° approach angle, for negative square inserts



Metric	h	b	L_1	h_1	f	r_{ϵ}^{**}	Insert
ESSNR1616H32	16	16	100	15.5	20	0.8	SN**0903...
ESSNR2020W	20	20	125	19.5	25	0.8	SN**1204...

**re: Standard corner radius

SPARE PARTS				
Designation	E-ring	Pin	Shim	Wrench
ESSNR1616H32	ER3	P322US	-	KY40
ESSNR2020W	ER3	P433W	ESS42	KY40

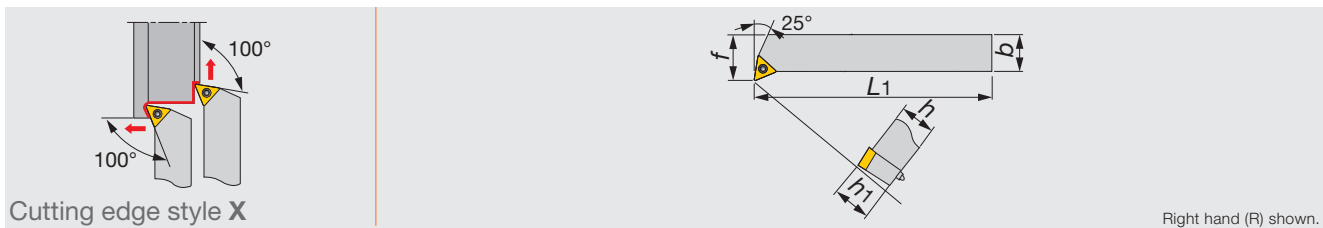

ETXNR/L

Pin lock toolholder with 100° approach angle, for negative triangle inserts



Metric	h	b	L_1	h_1	f	r_{ϵ}^{**}	Insert
ETXNL1616H33	16	16	100	15.5	20	0.8	TN**1604...
ETXNR2020K33	20	20	125	19.5	25	0.8	TN**1604...

**re: Standard corner radius

SPARE PARTS			
Designation	E-ring	Pin	Wrench
ETXNL1616H33	ER3	P332US	KY40
ETXNR2020K33	ER3	P333US	KY40

Reference pages

ESSNR/L: Inserts → **B073 -**, CBN → **B166 -**, PCD → **B178**ETXNR/L: Inserts → **B082 -**, CBN → **B166 -**, PCD → **B178**

CKJNR/L

Clamp-on toolholder with 93° approach angle, for negative 55° parallelogram inserts

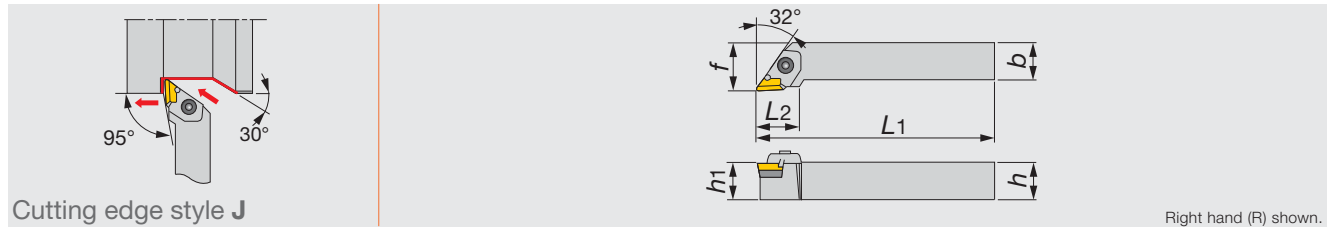

Metric	<i>h</i>	<i>b</i>	<i>L</i> ₁	<i>L</i> ₂	<i>h</i> ₁	<i>f</i>	<i>r</i> _ε **	Insert
CKJNR/L2525	25	25	150	32	25	32	0.8	KNMX1604...

**re: Standard corner radius

SPARE PARTS							
Designation	Clamp	Pin	Clamping screw	Shim screw	Shim	Spring	Wrench
CKJNR/L2525	CPK5R	BP-490	CTS-M6	SM3X0.5X10	CSK54R	SP913	P-4
CKJNL2525	CPK5L	BP-490	CTS-M6	SM3X0.5X10	CSK54L	SP913	P-4

CTGNR/L

Clamp-on toolholder with 91° approach angle, for negative triangle inserts

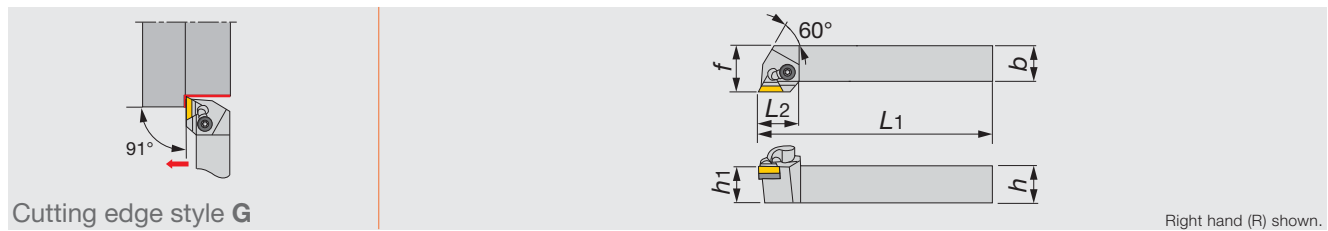

Metric	<i>h</i>	<i>b</i>	<i>L</i> ₁	<i>L</i> ₂	<i>h</i> ₁	<i>f</i>	<i>r</i> _ε **	Insert
CTGNR/L2020	20	20	125	28.5	20	25	0.8	TN**1604...
CTGNR/L2525	25	25	150	28.5	25	32	0.8	TN**1604...

**re: Standard corner radius

SPARE PARTS						
Designation	Chipbreaker piece	Clamp	Clamping screw	Shim screw	Shim	Wrench
CTGNR/L...	NCT-2M	NF-84A	NDS-8A	SM3X0.5X8	NAT-32	P-4

CSBNR/L

Clamp-on toolholder with 75° approach angle, for negative square inserts

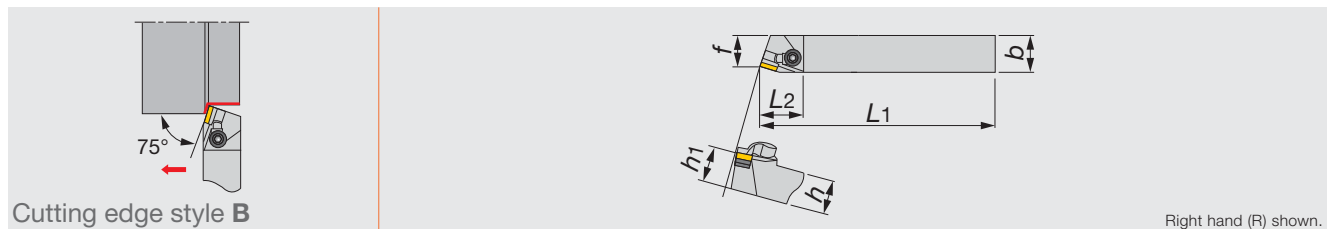

Metric	<i>h</i>	<i>b</i>	<i>L</i> ₁	<i>L</i> ₂	<i>h</i> ₁	<i>f</i>	<i>r</i> _ε **	Insert
CSBNR2020	20	20	125	31	20	17	0.8	SN**1204...
CSBNR/L2525	25	25	150	31	25	22	0.8	SN**1204...

**re: Standard corner radius

SPARE PARTS						
Designation	Chipbreaker piece	Clamp	Clamping screw	Shim screw	Shim	Wrench
CSBNR/L...	NCS-3M	NF-84A	NDS-8A	SM3X0.5X8	NAS-42	P-4

Reference pages

CKJNR/L: Inserts → **B105**

CTGNR/L: Inserts → **B092 -**, CBN → **B175**

CSBNR/L: Inserts → **B081**, CBN → **B175**, PCD → **B178**

**CSDNN**

Clamp-on toolholder with 45° approach angle, for negative square inserts

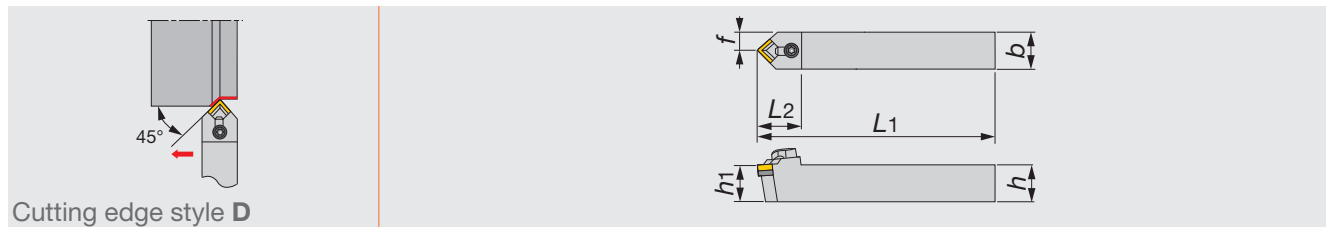

Cutting edge style D

Metric	h	b	L_1	L_2	h_1	f	r_{ϵ}^{**}	Insert
CSDNN2020	20	20	125	32	20	10	0.8	SN**1204...
CSDNN2525	25	25	150	32	25	12.5	0.8	SN**1204...

**re: Standard corner radius

SPARE PARTS

Designation	Chipbreaker piece	Clamp	Clamping screw	Shim screw	Shim	Wrench
CSDNN...	NCS-3MN	NF-84A	NDS-8A	SM3X0.5X8	NAS-42	P-4

CSSNR/L

Clamp-on toolholder with 45° approach angle (S-style), for negative square inserts

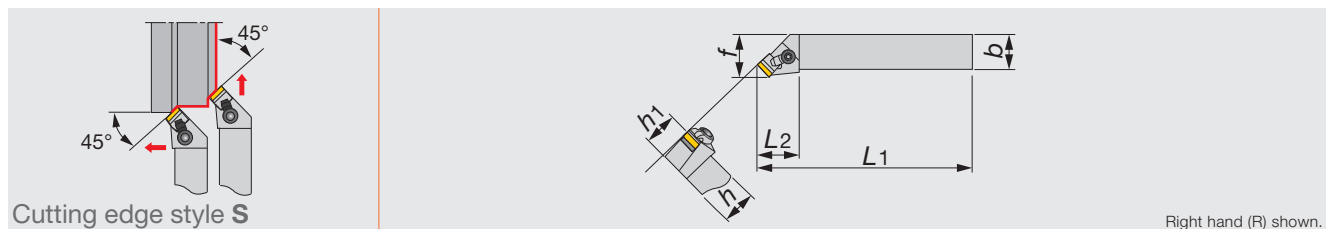

Cutting edge style S

Right hand (R) shown.

Metric	h	b	L_1	L_2	h_1	f	r_{ϵ}^{**}	Insert
CSSNR/L2020	20	20	125	31	20	25	0.8	SN**1204...
CSSNR/L2525	25	25	150	31	25	32	0.8	SN**1204...

**re: Standard corner radius

SPARE PARTS

Designation	Chipbreaker piece	Clamp	Clamping screw	Shim screw	Shim	Wrench
CSSNR/L...	NCS-3M	NF-84A	NDS-8A	SM3X0.5X8	NAS-42	P-4

CSKNR/L

Clamp-on toolholder with 75° approach angle, for negative square inserts

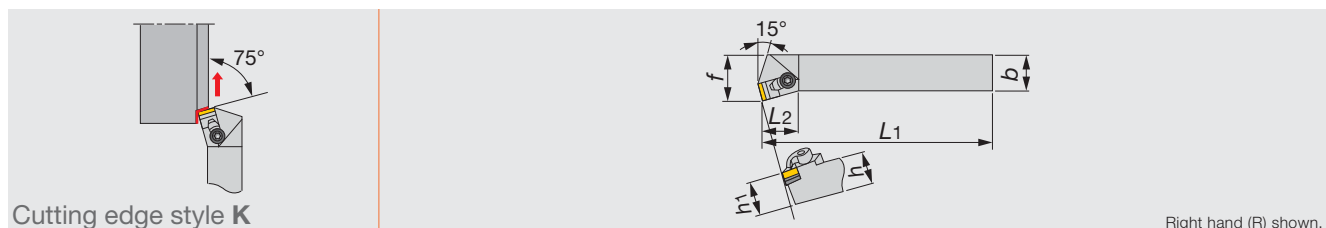

Cutting edge style K

Right hand (R) shown.

Metric	h	b	L_1	L_2	h_1	f	r_{ϵ}^{**}	Insert
CSKNR/L2525	25	25	150	25	25	32	0.8	SN**1204...

**re: Standard corner radius

SPARE PARTS

Designation	Chipbreaker piece	Clamp	Clamping screw	Shim screw	Shim	Wrench
CSKNR/L2525	NCS-3MN	NF-84A	NDS-8A	SM3X0.5X8	NAS-42	P-4

Reference pages

CSDNN, CSSNR/L, CSKNR/L: Inserts → B081, CBN → B175, PCD → B178

CTFNR/L

Clamp-on toolholder for facing with 91° approach angle, negative triangle inserts

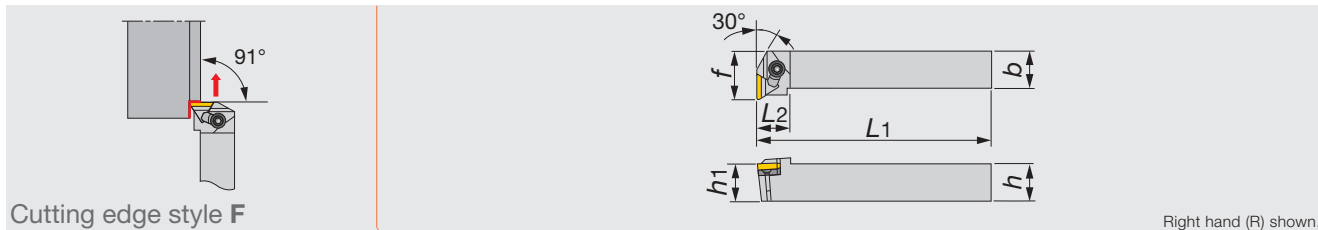

Metric	h	b	L1	L2	h1	f	r _e **	Insert
CTFNR/L2020	20	20	125	22	20	25	0.8	TN**1604...
CTFNR/L2525	25	25	150	22	25	32	0.8	TN**1604...

**re: Standard corner radius

SPARE PARTS

Designation	Chipbreaker piece	Clamp	Clamping screw	Shim screw	Shim	Wrench
CTFNR/L...	NCT-2M	NF-84A	NDS-8A	SM3X0.5X8	NAT-32	P-4

CTGPR/L

Clamp-on toolholder with 90° approach angle, for positive triangle inserts

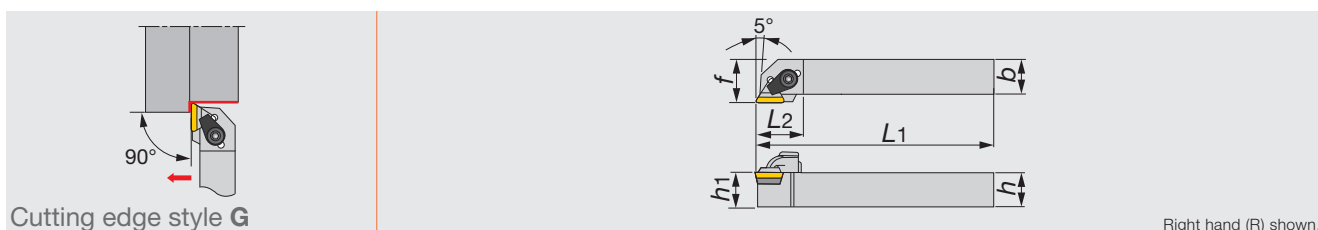

Metric	h	b	L1	L2	h1	f	r _e **	Insert
CTGPR/L1616H3	16	16	100	23	16	20	0.8	TP**1603...
CTGPR/L2020K3	20	20	125	27	20	25	0.8	TP**1603...
CTGPR/L2525M3	25	25	150	27	25	32	0.8	TP**1603...

**re: Standard corner radius

SPARE PARTS

Designation	Chipbreaker piece	Clamp set	Shim screw	Shim	Wrench
CTGPR/L1616H3	CBT-3M	CSG-6L	SM3X0.5X8	PAT-32	P-3
CTGPR/L2*2**3	CBT-3M	CSG-8	SM3X0.5X8	PAT-32	P-4

CSBPR/L

Clamp-on toolholder with 75° approach angle, for positive square inserts

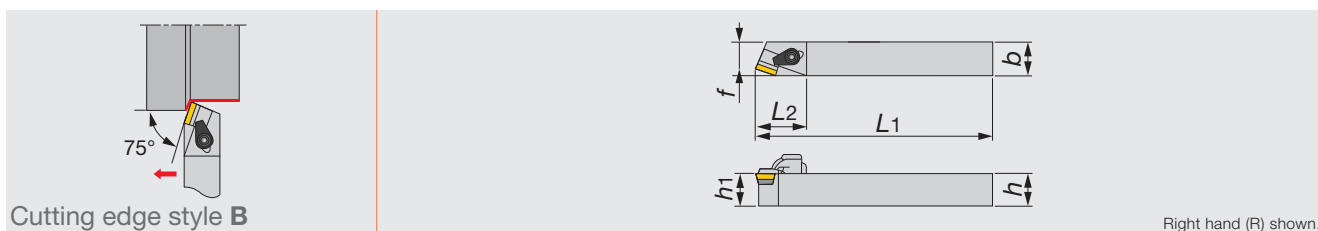

Metric	h	b	L1	L2	h1	f	r _e **	Insert
CSBPR/L1616H3	16	16	100	25	16	13	0.4	SP**0903...
CSBPR/L2020K4	20	20	125	32	20	17	0.8	SP**1203...
CSBPR/L2525M4	25	25	150	32	25	22	0.8	SP**1203...

**re: Standard corner radius

SPARE PARTS

Designation	Chipbreaker piece	Clamp set	Shim screw	Shim	Wrench
CSBPR/L1616H3	CBS-3M	CSG-6L	SM2.5X0.45X8	PAS-32	P-3
CSBPR/L2*2**4	CBS-4M	CSG-8	SM3X0.5X8	PAS-42	P-4

Reference pages

CTFNR/L: Inserts → **B092**, CBN → **B175**

CTGPR/L: Inserts → **B138 -**, CBN → **B172 -**, PCD → **B180**

CSBPR/L: Inserts → **B132**, CBN → **B170 -**, PCD → **B179**



CSDPN

Clamp-on toolholder with 45° approach angle, for positive square inserts

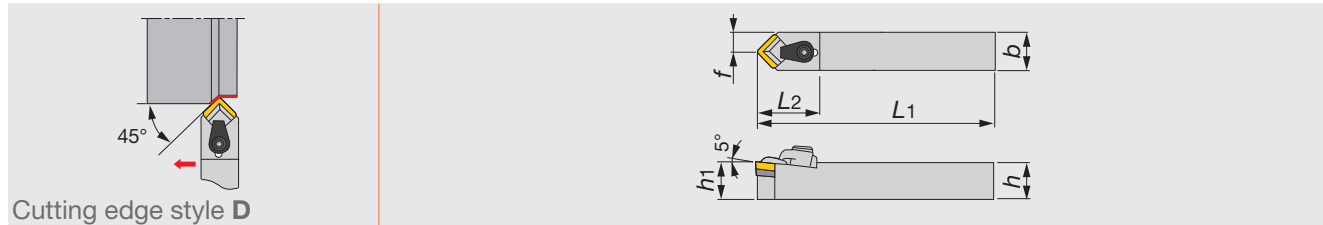

Metric	<i>h</i>	<i>b</i>	<i>L</i> ₁	<i>L</i> ₂	<i>h</i> ₁	<i>f</i>	<i>r</i> _ε **	Insert
CSDPN1616H3	16	16	100	26	16	8	0.8	SP**0903...
CSDPN2020K4	20	20	125	34	20	10	0.8	SP**1203...
CSDPN2525M4	25	25	150	34	25	12.5	0.8	SP**1203...

**re: Standard corner radius

SPARE PARTS

Designation	Chipbreaker piece	Clamp set	Shim screw	Shim	Wrench
CSDPN1616H3	CBS-3MN	CSG-6L	SM2.5X0.45X8	PAS-32	P-3
CSDPN2*2**4	CBS-4MN	CSG-8	SM3X0.5X8	PAS-42	P-4

CSSPR

Clamp-on toolholder with 45° approach angle, for positive square inserts

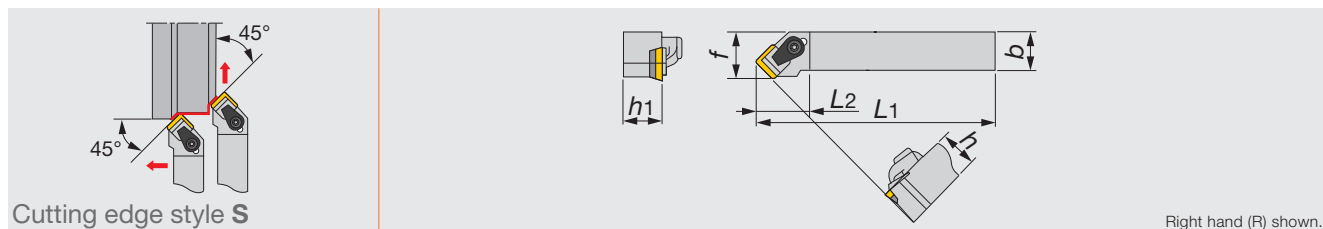

Right hand (R) shown.

Metric	<i>h</i>	<i>b</i>	<i>L</i> ₁	<i>L</i> ₂	<i>h</i> ₁	<i>f</i>	<i>r</i> _ε **	Insert
CSSPR1616H3	16	16	105.5	23	16	20	0.8	SP**0903...
CSSPR2020K4	20	20	133	28	20	25	0.8	SP**1203...
CSSPR2525M4	25	25	158	28	25	32	0.8	SP**1203...

**re: Standard corner radius

SPARE PARTS

Designation	Chipbreaker piece	Clamp set	Shim screw	Shim	Wrench
CSSPR1616H3	CBS-3M	CSG-6L	SM2.5X0.45X8	PAS-32	P-3
CSSPR2*2**4	CBS-4M	CSG-8	SM3X0.5X8	PAS-42	P-4

CTFPR/L

Clamp-on toolholder for facing with 91° approach angle, positive triangle inserts

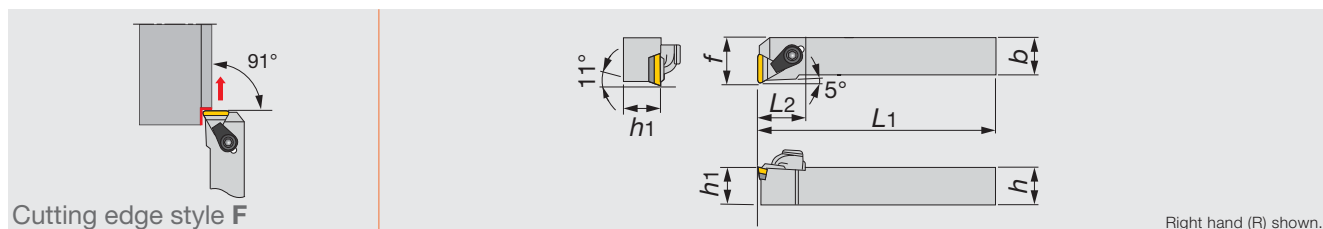

Right hand (R) shown.

Metric	<i>h</i>	<i>b</i>	<i>L</i> ₁	<i>L</i> ₂	<i>h</i> ₁	<i>f</i>	<i>r</i> _ε **	Insert
CTFPR/L1616H3	16	16	100	23	16	20	0.8	TP**1603...
CTFPR/L2020K3	20	20	125	26	20	25	0.8	TP**1603...
CTFPR/L2525M3	25	25	150	26	25	32	0.8	TP**1603...

**re: Standard corner radius

SPARE PARTS

Designation	Chipbreaker piece	Clamp set	Shim screw	Shim	Wrench
CTFPR/L1616H3	CBT-3M	CSG-6L	SM3X0.5X8	PAT-32	P-3
CTFPR/L2*2**3	CBT-3M	CSG-8	SM3X0.5X8	PAT-32	P-4

Reference pages

CSDPN, CSSPR: Inserts → **B132**, CBN → **B170 -**, PCD → **B179**

CTFPR/L: Inserts → **B145 -**, CBN → **B172 -**, PCD → **B180**

**CTCPR/L**

Clamp-on toolholder for facing with 90° approach angle, positive triangle inserts

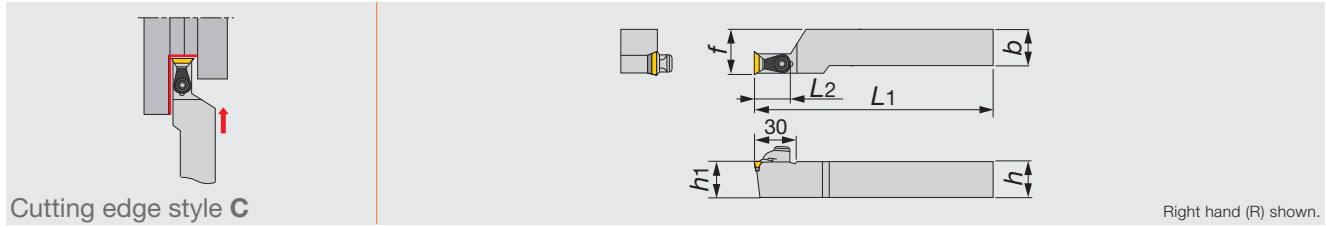

Metric	<i>h</i>	<i>b</i>	<i>L</i> ₁	<i>L</i> ₂	<i>h</i> ₁	<i>f</i>	<i>r</i> _ε **	Insert
CTCPR/L2525M3	25	25	150	32	25	32	0.8	TP**1603...

**re: Standard corner radius

SPARE PARTS

Designation	Chipbreaker piece	Clamp set	Shim screw	Shim	Wrench
CTCPR/L2525M3	CBT-3M	CSW-2	SM3X0.5X8	PAT-32	P-4

WTJNR/L

Wedge-on toolholder with 93° approach angle, for negative triangle inserts

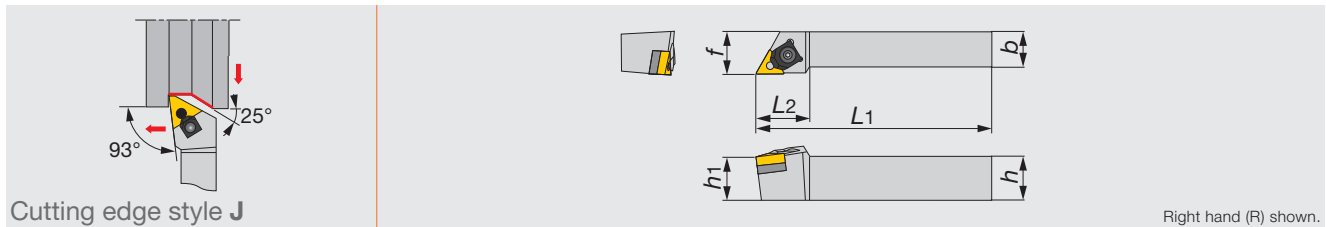

Metric	<i>h</i>	<i>b</i>	<i>L</i> ₁	<i>L</i> ₂	<i>h</i> ₁	<i>f</i>	<i>r</i> _ε **	Insert
WTJNR2020	20	20	125	31	20	25	0.8	TN**1604...
WTJNR/L2525M3	25	25	150	31	25	32	0.8	TN**1604...

**re: Standard corner radius

SPARE PARTS

Designation	Clamp	E-ring	Nut	Pin	Clamping screw	Shim	Wrench
WTJNR2020	WCW3	5103-25	WCN3S	WCP3S	WCS3	WST33	P-3
WTJNR/L2525M3	WCW3	5103-25	WCN3	WCP3S	WCS3	WST33	P-3

HSRNR/L

Retract-pin clamp toolholder with 75° approach angle, for negative square inserts

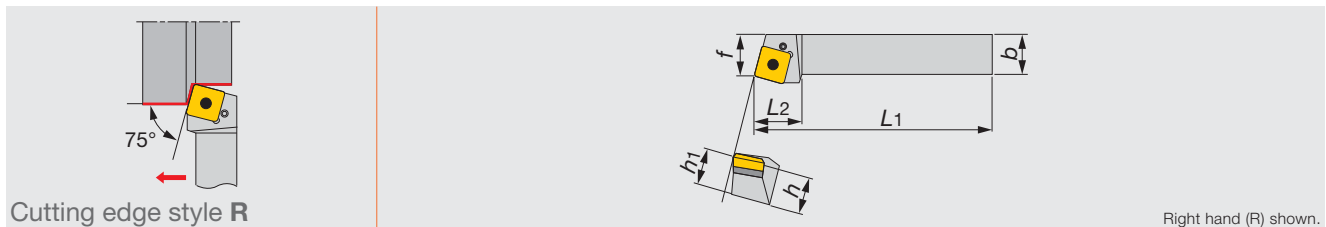

Metric	<i>h</i>	<i>b</i>	<i>L</i> ₁	<i>L</i> ₂	<i>h</i> ₁	<i>f</i>	<i>r</i> _ε **	Insert
HSRNR/L4040R	40	40	200	50	40	43	1.6	SNMM3109...
HSRNR/L5050S	50	50	250	60	50	53	1.6	SNMM3109...

**re: Standard corner radius

SPARE PARTS

Designation	Pin	Clamping screw	Shim	Wrench
HSRNR/L...	SW99	LS-8	NAS-04	P-4

Reference pages

CTCPR/L: Inserts → **B145 -**, CBN → **B172 -**, PCD → **B180**WTJNR/L: Inserts → **B082 -**, CBN → **B166 -**, PCD → **B178**

**SCLCR/L**

Screw-on clamp toolholder with 95° approach angle, for positive 80° rhombic inserts

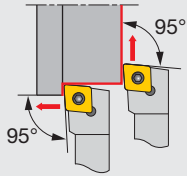

Cutting edge style L

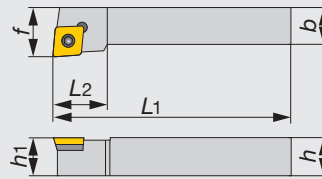

Right hand (R) shown.

Inch	h	b	L1	L2	h1	f	r _e **	Insert
SCLCR/L 103	0.625	0.625	4.000	0.625	0.625	0.750	0.031	CC**32.5...
SCLCR/L 123	0.750	0.750	4.500	0.625	0.750	0.750	0.031	CC**32.5...
SCLCR/L 163	1.000	1.000	6.000	0.625	1.000	0.750	0.031	CC**32.5...
SCLCR/L 124B	0.750	0.750	4.500	0.625	0.750	0.750	0.031	CC**43...
SCLCR/L 164D	1.000	1.000	6.000	0.750	1.000	0.750	0.031	CC**43...

Metric	h	b	L1	L2	h1	f	r _e **	Insert
SCLCR/L1616H09	16	16	100	16	16	20	0.8	CC**09T3...
SCLCR/L2020K12	20	20	125	20	20	25	0.8	CC**1204...

r_e: Standard corner radiusSPARE PARTS**

Designation	Clamping screw	Shim screw	Shim	Wrench 1	Wrench 2
SCLCR/L103, 123, 163 SCLCR/L1616H09	CSTB-3.5L	DTS5-3.5	SSC32	P-3.5	T-15F
SCLCR/L124B, 164D SCLCR/L2020K12	CSTB-4F	DTS6-4	SSC4T3	P-4	T-15F

SDJCR/L

Screw-on clamp toolholder with 93° approach angle, for positive 55° rhombic inserts

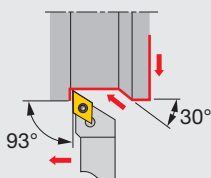

Cutting edge style J

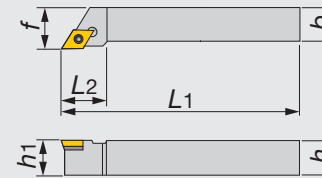

Right hand (R) shown.

Inch	h	b	L1	L2	h1	f	r _e **	Insert
SDJCR/L 062	0.375	0.375	2.500	0.625	0.375	0.500	0.016	DC**21.5...
SDJCR/L 082	0.500	0.500	3.500	0.625	0.500	0.625	0.016	DC**21.5...
SDJCR/L 083	0.500	0.500	3.500	-	0.500	0.625	0.016	DC**32.5...
SDJCR/L 103	0.625	0.625	4.000	-	0.625	0.750	0.031	DC**32.5...
SDJCR/L 123	0.750	0.750	4.500	-	0.750	1.000	0.031	DC**32.5...
SDJCR/L 163	1.000	1.000	6.000	-	1.000	1.250	0.031	DC**32.5...

Metric	h	b	L1	L2	h1	f	r _e **	Insert
SDJCR1616H11	16	16	100	20	16	20	0.8	DC**11T3...
SDJCR/L2020K11	20	20	125	20.5	20	25	0.8	DC**11T3...
SDJCR/L2525M11	25	25	150	21.5	25	32	0.8	DC**11T3...

SPARE PARTS

Designation	Clamping screw	Shim screw	Shim	Wrench 1	Wrench 2
SDJCR/L 062, 082	CSTB-2.5	DTS5-3.5	SSD32	P-3.5	T-15F
SDJCR/L 083, 103, 123, 163 SDJCR/L1616..., 2020..., 2525...	CSTB-3.5L	DTS5-3.5	SSD32	P-3.5	T-15F

Reference pages

SCLCR/L: Inserts → **B106 -**, CBN → **B170 -**, PCD → **B179**SDJCR/L: Inserts → **B116 -**, CBN → **B170 -**, PCD → **B179**

**SVJCR/L**

Screw-on clamp toolholder with 93° approach angle, for positive 35° rhombic inserts

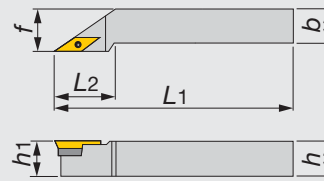
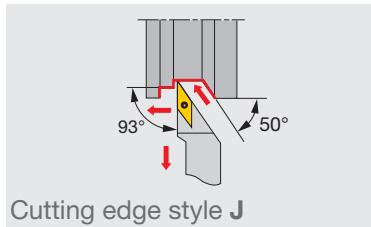

Right hand (R) shown.

Inch	<i>h</i>	<i>b</i>	<i>L</i> ₁	<i>L</i> ₂	<i>h</i> ₁	<i>f</i>	<i>r</i> _ε **	Insert
SVJCR/L103	0.625	0.625	4.500	1.000	0.625	0.725	0.031	VC**33...
SVJCR/L123	0.750	0.750	4.500	1.250	0.750	0.955	0.031	VC**33...
SVJCR/L163	1.000	1.000	6.000	1.500	1.000	1.250	0.031	VC**33...
Metric	<i>h</i>	<i>b</i>	<i>L</i> ₁	<i>L</i> ₂	<i>h</i> ₁	<i>f</i>	<i>r</i> _ε **	Insert
SVJCR/L1616H16	16	16	100	32	16	20	0.8	VC**1604...
SVJCR/L2020K16	20	20	125	32	20	25	0.8	VC**1604...
SVJCR/L2525M16	25	25	150	40	25	32	0.8	VC**1604...

***r*_ε: Standard corner radius**SPARE PARTS**

Designation	Clamping screw	Shim screw	Shim	Wrench 1	Wrench 2
SVJCR/L...	CSTB-3.5L	DTS5-3.5	SSV32	P-3.5	T-15F

SDNCN

Screw-on clamp toolholder with 62.5° approach angle, for positive 55° rhombic inserts

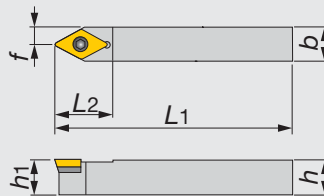
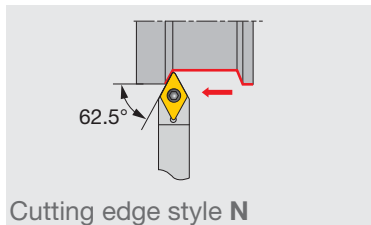

Metric	<i>h</i>	<i>b</i>	<i>L</i> ₁	<i>L</i> ₂	<i>h</i> ₁	<i>f</i>	<i>r</i> _ε **	Insert
SDNCN1616H11	16	16	100	21	16	8	0.8	DC**11T3...
SDNCN2020K11	20	20	125	21	20	10	0.8	DC**11T3...
SDNCN2525M11	25	25	150	21	25	12.5	0.8	DC**11T3...

***r*_ε: Standard corner radius**SPARE PARTS**

Designation	Clamping screw	Shim screw	Shim	Wrench 1	Wrench 2
SDNCN...	CSTB-3.5L	DTS5-3.5	SSD32	P-3.5	T-15F

Reference pages

SVJCR/L: Inserts → **B149** -, CBN → **B171** -, PCD → **B179** -SDNCN: Inserts → **B116** -, CBN → **B170** -, PCD → **B179**



SVVCN

Screw-on clamp toolholder with 72.5° approach angle, for positive 35° rhombic inserts

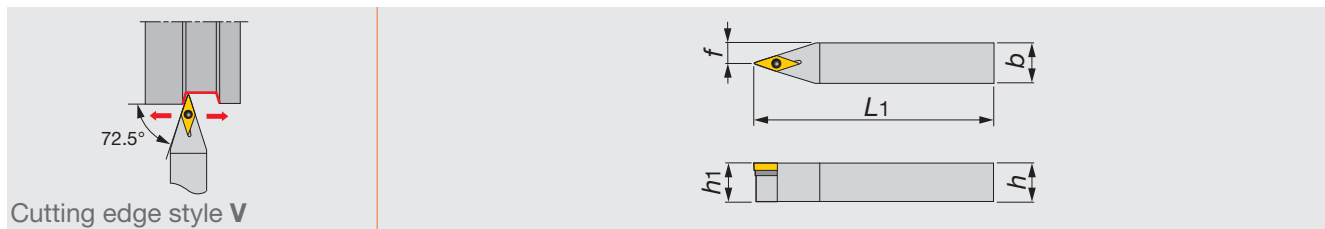

Cutting edge style V

Metric	<i>h</i>	<i>b</i>	<i>L</i> ₁	<i>h</i> ₁	<i>f</i>	<i>r</i> _c **	Insert
SVVCN2020K16	20	20	125	20	10	0.8	VC**1604...
SVVCN2525M16	25	25	150	25	12.5	0.8	VC**1604...

**re: Standard corner radius

SPARE PARTS

Designation	Clamping screw	Shim screw	Shim	Wrench 1	Wrench 2
SVVCN...	CSTB-3.5L	DTS5-3.5	SSV32	P-3.5	T-15F

STACR/L

Screw-on toolholder with 91° approach angle, for positive triangle inserts

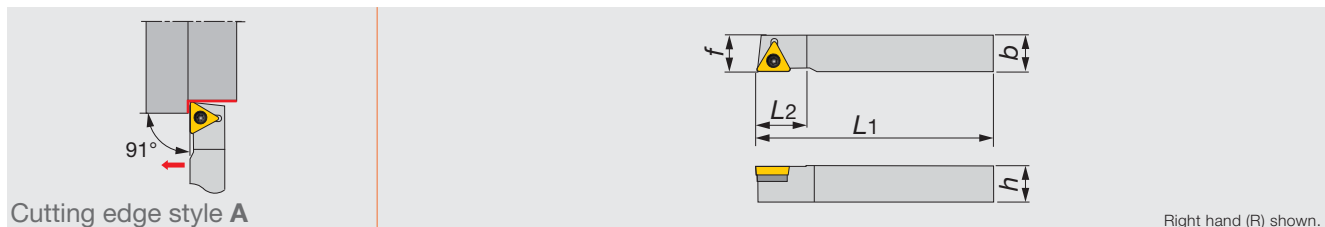

Cutting edge style A

Right hand (R) shown.

Metric	<i>h</i>	<i>b</i>	<i>L</i> ₁	<i>L</i> ₂	<i>h</i> ₁	<i>f</i>	<i>r</i> _c **	Insert
STACR/L1616H16	16	16	100	22.5	16	16	0.8	TC**16T3...

**re: Standard corner radius

SPARE PARTS

Designation	Clamping screw	Shim screw	Shim	Wrench 1	Wrench 2
STACR/L...	CSTB-3.5L	DTS5-3.5	SST32	P-3.5	T-15F

Reference pages

SVVCN: Inserts → B149 -, CBN → B171 -, PCD → B179 -

STACR/L: Inserts → B133 -

**SRACR/L**

Screw-on toolholder with 91° approach angle, for positive round inserts

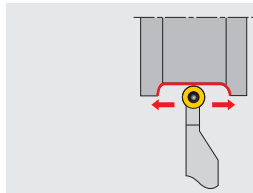

Cutting edge style A

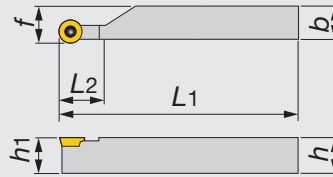

Right hand (R) shown.

Metric	<i>h</i>	<i>b</i>	<i>L</i> ₁	<i>L</i> ₂	<i>h</i> ₁	<i>f</i>	Insert
SRACR1010H05	10	10	100	10	10	10.3	RCMT0502...
SRACR/L1212H05	12	12	100	10	12	12.3	RCMT0502...
SRACR/L1212H06	12	12	100	12	12	12.4	RC* <i>T</i> 0602...
SRACR1616H05	16	16	100	10	16	16.3	RCMT0502...
SRACR/L1616H06	16	16	100	12	16	16.4	RC* <i>T</i> 0602...
SRACR/L1616H08	16	16	100	16	16	16.5	RC* <i>T</i> 0803...
SRACR/L2020K05	20	20	125	10	20	20.3	RCMT0502...
SRACR/L2020K06	20	20	125	12	20	20.4	RC* <i>T</i> 0602...
SRACR/L2020K08	20	20	125	16	20	20.5	RC* <i>T</i> 0803...
SRACR/L2525M05	25	25	150	10	25	25.3	RCMT0502...
SRACR/L2525M06	25	25	150	12	25	25.4	RC* <i>T</i> 0602...
SRACR/L2525M08	25	25	150	16	25	25.5	RC* <i>T</i> 0803...

SPARE PARTS

Designation	Clamping screw	Wrench
SRACR/L1*1*H05	CSTB-2.2R	T-7F
SRACR/L1212H06	CSTB-2.5	T-8F
SRACR1616H05	CSTB-2.2R	T-7F
SRACR/L1616H06	CSTB-2.5	T-8F
SRACR/L1616H08	CSTB-3	T-9F
SRACR/L2020K05	CSTB-2.2R	T-7F
SRACR/L2020K06	CSTB-2.5	T-8F
SRACR/L2020K08	CSTB-3	T-9F
SRACR/L2525M05	CSTB-2.2R	T-7F
SRACR/L2525M06	CSTB-2.5	T-8F
SRACR/L2525M08	CSTB-3	T-9F

Reference pages

SRACR/L: Inserts → **B126** -

**SRGCR/L**

Screw-on toolholder with 91° approach angle, for positive round inserts

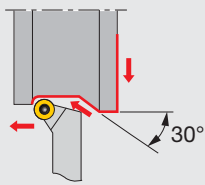

Cutting edge style G

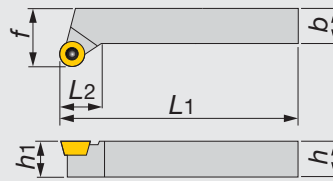

Right hand (R) shown.

Metric	<i>h</i>	<i>b</i>	<i>L</i> ₁	<i>L</i> ₂	<i>h</i> ₁	<i>f</i>	Insert
SRGCR1212H05	12	12	100	9.5	12	16	RCMT0502...
SRGCR/L1212H06	12	12	100	10	12	16	RC*T0602...
SRGCR/L1616H05	16	16	100	9.5	16	20	RCMT0502...
SRGCR/L1616H06	16	16	100	10	16	20	RC*T0602...
SRGCR/L1616H08	16	16	100	11	16	20	RC*T0803...
SRGCR/L2020K05	20	20	125	11.2	20	25	RCMT0502...
SRGCR/L2020K06	20	20	125	12	20	25	RC*T0602...
SRGCR/L2020K08	20	20	125	12.7	20	25	RC*T0803...
SRGCR/L2020K10	20	20	125	14	25	25	RC*T1003...
SRGCR/L2525M05	25	25	150	14.7	25	32	RCMT0502...
SRGCR/L2525M06	25	25	150	15	25	32	RC*T0602...
SRGCR/L2525M08	25	25	150	16.2	25	32	RC*T0803...
SRGCR/L2525M10	25	25	150	17.5	25	32	RC*T1003...

SPARE PARTS

Designation	Clamping screw	Shim screw	Shim	Wrench 1	Wrench 2
SRGCR1212H05	CSTB-2.2R	-	-	-	T-7F
SRGCR/L1212H06	CSTB-2.5	-	-	-	T-8F
SRGCR/L1616H05	CSTB-2.2R	-	-	-	T-7F
SRGCR/L1616H06	CSTB-2.5	-	-	-	T-8F
SRGCR/L1616H08	CSTB-3	-	-	-	T-9F
SRGCR/L2020K05	CSTB-2.2R	-	-	-	T-7F
SRGCR/L2020K06	CSTB-2.5	-	-	-	T-8F
SRGCR/L2020K08	CSTB-3	-	-	-	T-9F
SRGCR/L2020K10	CSTB-3.5L	DTS5-3.5	SSR32	P-3.5	T-15F
SRGCR/L2525M05	CSTB-2.2R	-	-	-	T-7F
SRGCR/L2525M06	CSTB-2.5	-	-	-	T-8F
SRGCR/L2525M08	CSTB-3	-	-	-	T-9F
SRGCR/L2525M10	CSTB-3.5L	DTS5-3.5	SSR32	P-3.5	T-15F

Reference pages

SRGCR/L: Inserts → **B126** -

**SSDC/PN**

Screw-on clamp toolholder with 45° approach angle, for positive square inserts

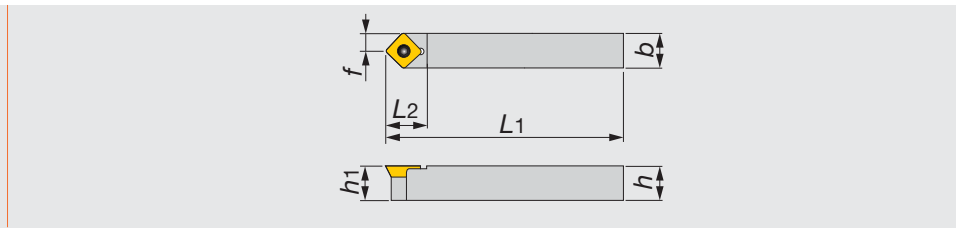
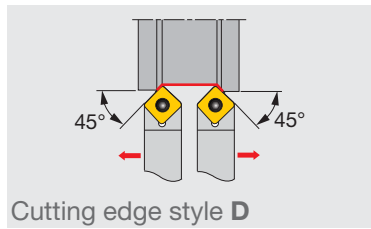

Metric	<i>h</i>	<i>b</i>	<i>L</i> ₁	<i>L</i> ₂	<i>h</i> ₁	<i>f</i>	<i>r</i> _ε **	Insert
SSDCN1010K07	10	10	125	12	10	5	0.4	SC**0702...
SSDPN1010H	10	10	100	12	10	5	0.4	SP*P042...
SSDCN1212K09	12	12	125	15	12	6	0.8	SC**09T3...
SSDPN1212H	12	12	100	12	12	6	0.4	SP*P042...
SSDCN1616H09	16	16	100	15	16	8	0.8	SC**09T3...
SSDPN1616H	16	16	100	14	16	8	0.8	SP*M322...

***r*_ε: Standard corner radius**SPARE PARTS**

Designation	Clamping screw	Shim screw	Shim	Wrench 1	Wrench 2
SSDCN1010K07	CSTB-3	-	-	-	T-9F
SSDPN1010H	CSTA-NO3	-	-	-	T-9F
SSDCN1212K09	CSTB-4	-	-	-	T-15F
SSDPN1212H	CSTA-NO3	-	-	-	T-9F
SSDCN1616H09	CSTB-3.5L	DTS5-3.5	SSS32	P-3.5	T-15F
SSDPN1616H	CSTA-NO5	-	-	-	T-9F

SRDCN

Screw-on toolholder with 45° approach angle, for positive round inserts

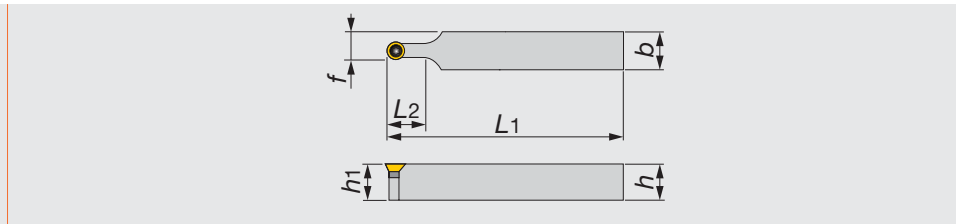
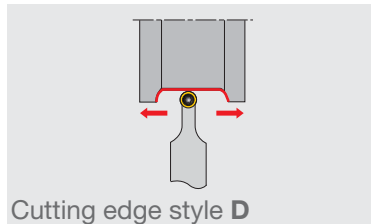

Metric	<i>h</i>	<i>b</i>	<i>L</i> ₁	<i>L</i> ₂	<i>h</i> ₁	<i>f</i>	Insert
SRDCN1212K08	12	12	125	16	12	10	RC*T0803...
SRDCN1212K10	12	12	125	20.3	12	11	RC*T1003...
SRDCN1616M08	16	16	150	16	16	12	RC*T0803...
SRDCN1616M10	16	16	150	20.3	16	13	RC*T1003...
SRDCN2020K06	20	20	125	12	20	13	RC*T0602...
SRDCN2020K08	20	20	125	16	20	14	RC*T0803...
SRDCN2020K10	20	20	125	20.3	25	15	RC*T1003...
SRDCN2525M06	25	25	150	12	25	15.5	RC*T0602...
SRDCN2525M08	25	25	150	16	25	16.5	RC*T0803...
SRDCN2525M10	25	25	150	20.3	25	17.5	RC*T1003...

SPARE PARTS

Designation	Clamping screw	Shim screw	Shim	Wrench 1	Wrench 2
SRDCN**08	CSTB-3	-	-	-	T-9F
SRDCN**10	CSTB-3.5L	DTS5-3.5	SSR32	P-3.5	T-15F
SRDCN2**06	CSTB-2.5	-	-	-	T-8F

Reference pages

SSDC/PN: Inserts → **B129, E094**SRDCN: Inserts → **B126 -**

**SDQCR/L**

Screw-on clamp toolholder with 107.5° approach angle, for positive 55° rhombic inserts

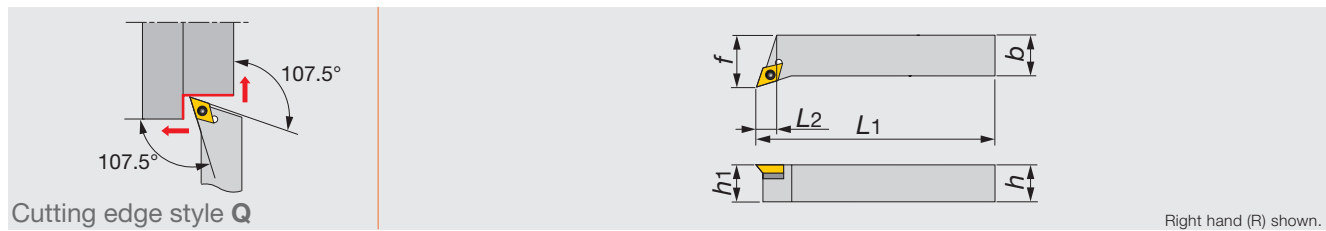

Metric	<i>h</i>	<i>b</i>	<i>L</i> ₁	<i>L</i> ₂	<i>h</i> ₁	<i>f</i>	<i>r</i> _ε **	Insert
SDQCR/L2020K11	20	20	125	20.5	20	25	0.8	DC**11T3...
SDQCR2525M11	25	25	150	21.5	25	32	0.8	DC**11T3...

**re: Standard corner radius

SPARE PARTS

Designation	Clamping screw	Shim screw	Shim	Wrench 1	Wrench 2
SDQCR/L...	CSTB-3.5L	DTS5-3.5	SSD32	P-3.5	T-15F

SVQCR/L

Screw-on clamp toolholder with 117.5° approach angle, for positive 35° rhombic inserts

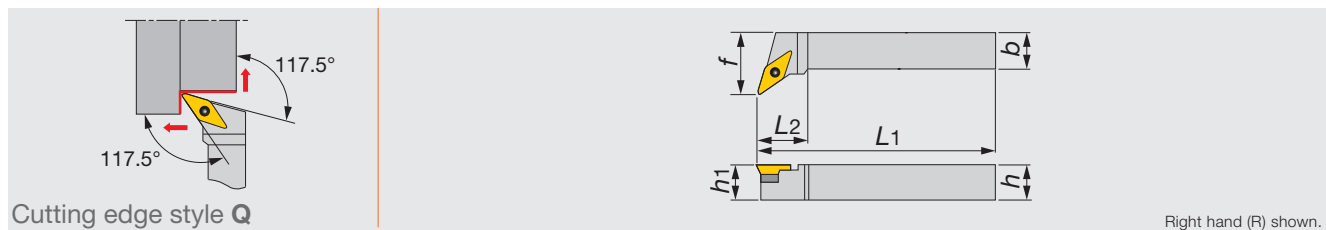

Inch	<i>h</i>	<i>b</i>	<i>L</i> ₁	<i>L</i> ₂	<i>h</i> ₁	<i>f</i>	<i>r</i> _ε **	Insert
SVQCR/L163	1.00	1.00	6.00	1.50	1.00	1.25	0.031	VC**33...

Metric	<i>h</i>	<i>b</i>	<i>L</i> ₁	<i>L</i> ₂	<i>h</i> ₁	<i>f</i>	<i>r</i> _ε **	Insert
SVQCR/L2020K16	20	20	125	35	20	27	0.8	VC**1604...
SVQCR/L2525M16	25	25	150	35	25	32	0.8	VC**1604...

**re: Standard corner radius

SPARE PARTS

Designation	Clamping screw	Shim screw	Shim	Wrench 1	Wrench 2
SVQCR/L...	CSTB-3.5L	DTS5-3.5	SSV32	P-3.5	T-15F

Reference pages

SDQCR/L: Inserts → **B116 -**, CBN → **B170 -**, PCD → **B179**SVQCR/L: Inserts → **B149 -**, CBN → **B171 -**, PCD → **B179 -**

SVHCR/L

Screw-on clamp toolholder with 107.5° approach angle, for positive 35° rhombic inserts

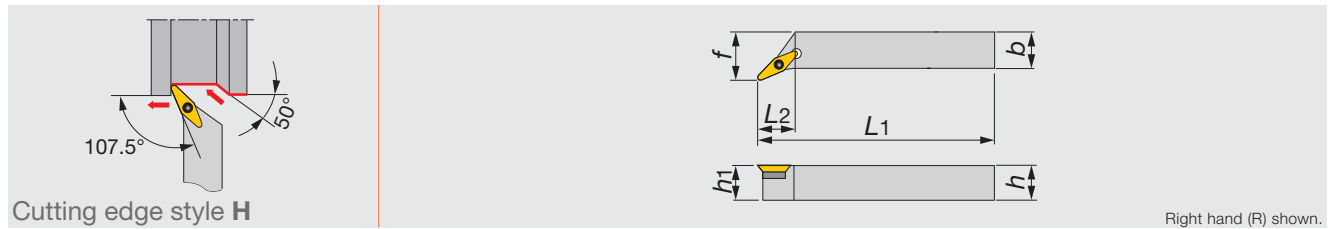

Metric	h	b	L1	L2	h1	f	r _ε **	Insert
SVHCR/L2525M22	25	25	150	33.8	25	32	0.8	VCG*2205...

**re: Standard corner radius

SPARE PARTS

Designation	Clamping screw	Shim screw	Shim	Wrench 1	Wrench 2
SVHCR/L2525M22	CSTB-4.5L110P	DTS6-4.5	SSV42	P-4.5	T-15F

TRACN

Taper-lock toolholder with 91° approach angle, for RT type tapered round inserts

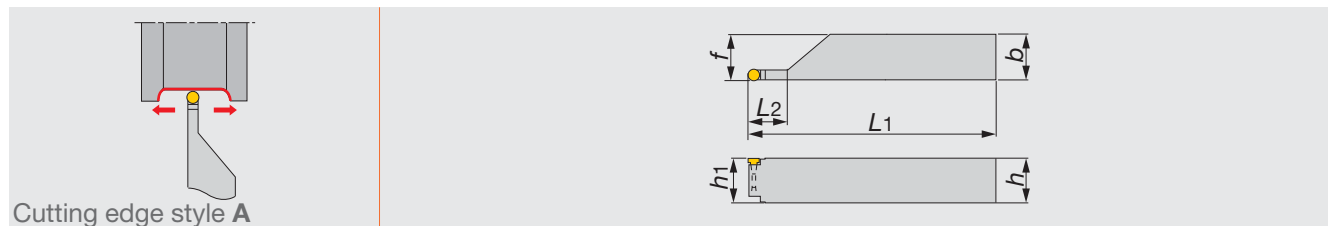

Metric	h	b	L1	L2	h1	f	Insert
TRACN2020K05	20	20	125	20	20	20.3	RT05
TRACN2020K06	20	20	125	22	20	20.4	RT06
TRACN2525M05	25	25	150	20	25	25.3	RT05
TRACN2525M06	25	25	150	22	25	25.4	RT06
TRACN2525M08	25	25	150	25	25	25.5	RT08

TRDCN

Taper-lock toolholder with 45° approach angle, for RT type tapered round inserts

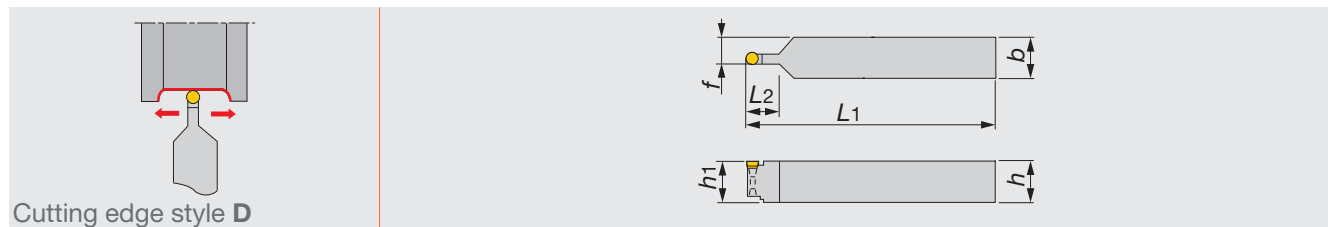

Metric	h	b	L1	L2	h1	f	Insert
TRDCN2020K05	20	20	125	20	20	12.5	RT05
TRDCN2525M05	25	25	150	20	25	15	RT05
TRDCN2525M06	25	25	150	22	25	15.5	RT06

Reference pages

SVHCR/L: Inserts → **B150**

TRACN, TRDCN: Inserts → **B127**

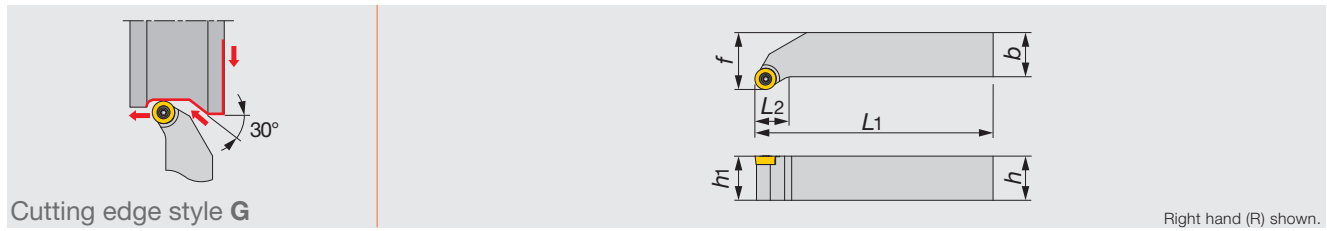

Cutting edge style G

Right hand (R) shown.

Inch	<i>h</i>	<i>b</i>	<i>L</i> ₁	<i>L</i> ₂	<i>h</i> ₁	<i>f</i>	Insert	Torque*
SRGCR/L164-6F	1.00	1.00	6.00	0.69	1.00	1.25	RCMT1204M0-6RS/-6RM	2.21
Metric	<i>h</i>	<i>b</i>	<i>L</i> ₁	<i>L</i> ₂	<i>h</i> ₁	<i>f</i>	Insert	Torque*
SRGCR/L2525M12-6F	25	25	150	18.6	25	32	RCMT1204M0-6RS/-6RM	3

*Torque: Recommended torque (lbf-ft, N-m) for clamping

SPARE PARTS

Designation	Clamping screw	Lubricant	Wrench
SRGCR/L164-6F, SRGCR/L2525M12-6F	CSTB-4	M-1000	T-15F

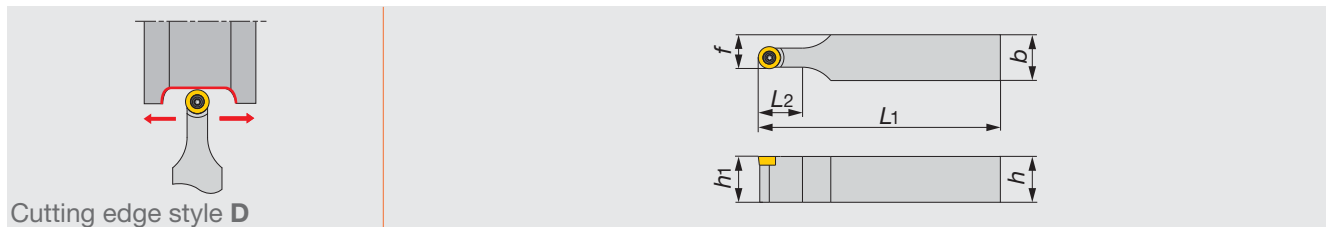

Cutting edge style D

Inch	<i>h</i>	<i>b</i>	<i>L</i> ₁	<i>L</i> ₂	<i>h</i> ₁	<i>f</i>	Insert	Torque*
SRDCN164-6F	1.00	1.00	6.00	0.95	1.00	0.74	RCMT1204M0-6RS/-6RM	2.21
Metric	<i>h</i>	<i>b</i>	<i>L</i> ₁	<i>L</i> ₂	<i>h</i> ₁	<i>f</i>	Insert	Torque*
SRDCN2525M12-6F	25	25	150	24.1	25	18.5	RCMT1204M0-6RS/-6RM	3

*Torque: Recommended torque (lbf-ft, N-m) for clamping

SPARE PARTS

Designation	Clamping screw	Lubricant	Wrench
SRDCN164-6F, SRDCN2525M12-6F	CSTB-4	M-1000	T-15F

Reference pages

SRGCR/L, SRDCN: Inserts → B270, Standard cutting conditions → B270

**INSERT****RCMT**

6RS



6RM

Designation	Coated		Cermet	ϕd (in)	s (in)	ϕd_1 (in)
	T9115	T9125	NS9530			
RCMT1204M0-6RS	●	●	●	0.472	0.187	0.203
RCMT1204M0-6RM	●	●	●	0.472	0.187	0.203

● : Line up

STANDARD CUTTING CONDITIONS

ISO	Workpiece material	Chip-breaker	Grade	Cutting speed V_c (sfm)	Depth of cut a_p (in)	Feed f (ipr)
P	Steels 1045, etc.	6RS	T9115	492 - 984	0.020 - 0.079	0.020 - 0.039
		6RS	T9125	394 - 820	0.020 - 0.079	0.020 - 0.039
		6RS	NS9530	492 - 820	0.020 - 0.079	0.020 - 0.039
		6RM	T9115	492 - 984	0.039 - 0.118	0.020 - 0.039
		6RM	T9125	394 - 820	0.039 - 0.118	0.020 - 0.039
		6RM	NS9530	492 - 820	0.039 - 0.118	0.020 - 0.039

DIMPLEFX

CCLNR/L-RD

Double clamp toolholder for ceramic insert with dimple, 95° approach angle, for negative 80° rhombic inserts



Ext. Toolholder

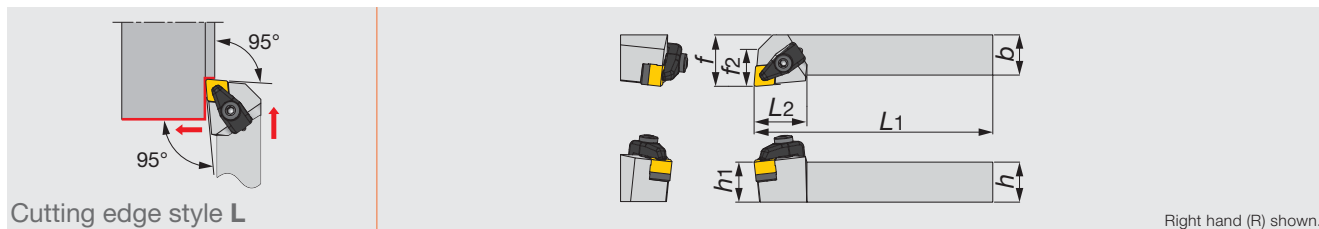

Inch	h	b	L_1	L_2	h_1	f	f_2	r_{e}^{**}	Insert	Torque*
CCLNR/L16M45-RD	1.000	1.000	6.000	1.300	1.000	1.250	0.910	0.047	CNGD45...	3.0

*Torque: Recommended torque (lbf-ft) for clamping
 **re: Standard corner radius

SPARE PARTS							
Designation	Clamp	Clamp screw	Shim	Shim screw	Spring	Wrench 1	Wrench 2
CCLNR/L*-RD	CCP4-A	CCS4-A	CC44-A	BH5-10-A	BP-5-A	P-3	P-4

DIMPLEFX

CDJNR/L-RD

Double clamp toolholder for ceramic insert with dimple, 93° approach angle, for negative 55° rhombic inserts

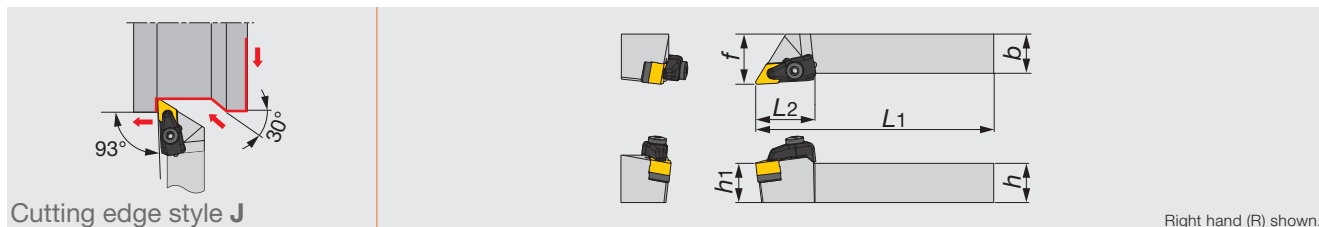

Inch	h	b	L_1	L_2	h_1	f	r_{e}^{**}	Insert	Torque*
CDJNR/L16M45-RD	1.000	1.000	6.000	1.500	1.000	1.250	0.047	DNGD45...	3.0

*Torque: Recommended torque (lbf-ft) for clamping
 **re: Standard corner radius

SPARE PARTS							
Designation	Clamp	Clamp screw	Shim	Shim screw	Spring	Wrench 1	Wrench 2
CDJNR/L*-RD	CCP4-A	CCS4-A	CD44-A	BH5-10-A	BP-5-A	P-3	P-4

Reference pages

CCLNR/L-RD: Inserts → **B062**, Standard cutting conditions → **B274**

CDJNR/L-RD: Inserts → **B071**, Standard cutting conditions → **B274**



DIMPLEFX

CDNNN-RD

Double clamp toolholder for ceramic insert with dimple, 63° approach angle, for negative 55° rhombic inserts

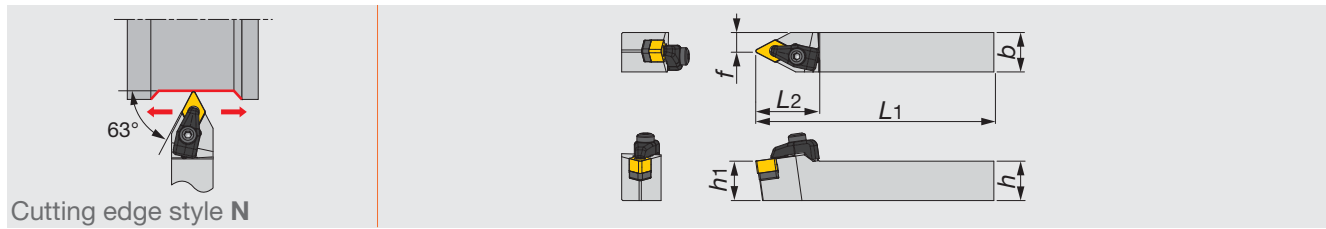

Cutting edge style N

Inch	h	b	L1	L2	h1	f	re**	Insert	Torque*
CDNNN16M45-RD	1.000	1.000	6.000	1.580	1.000	0.500	0.047	DNGD45...	3.0

*Torque: Recommended torque (lbf-ft) for clamping

**re: Standard corner radius

SPARE PARTS

Designation	Clamp	Clamp screw	Shim	Shim screw	Spring	Wrench 1	Wrench 2
CDNNN16M45-RD	CCP4-A	CCS4-A	CD44-A	BH5-10-A	BP-5-A	P-3	P-4

DIMPLEFX

CVVNN-RD

Double clamp toolholder for ceramic insert with dimple, 72.5° approach angle, for negative 35° rhombic inserts

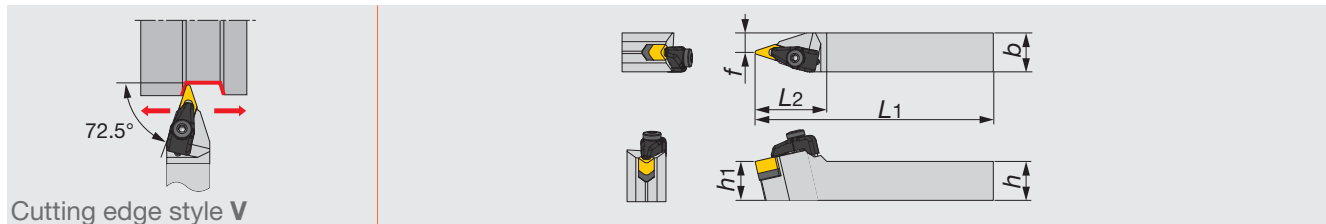

Cutting edge style V

Inch	h	b	L1	L2	h1	f	re**	Insert	Torque*
CVVNN16M35-RD	1.000	1.000	6.000	1.810	1.000	0.500	0.047	VNGD35...	3.0

*Torque: Recommended torque (lbf-ft) for clamping

**re: Standard corner radius

SPARE PARTS

Designation	Clamp	Clamp screw	Shim	Shim screw	Spring	Wrench 1	Wrench 2
CVVNN16M35-RD	CCP4-A	CCS4-A	CV34-A	BH-4-10-A	BP-5-A	P-3	P-4

Reference pages

CDNNN-RD: Inserts → **B071**, Standard cutting conditions → **B274**

CVVNN-RD: Inserts → **B096**, Standard cutting conditions → **B274**

DIMPLEFX

CSSNR/L-RD

Double clamp toolholder for ceramic insert with dimple, 45° approach angle, for negative square inserts

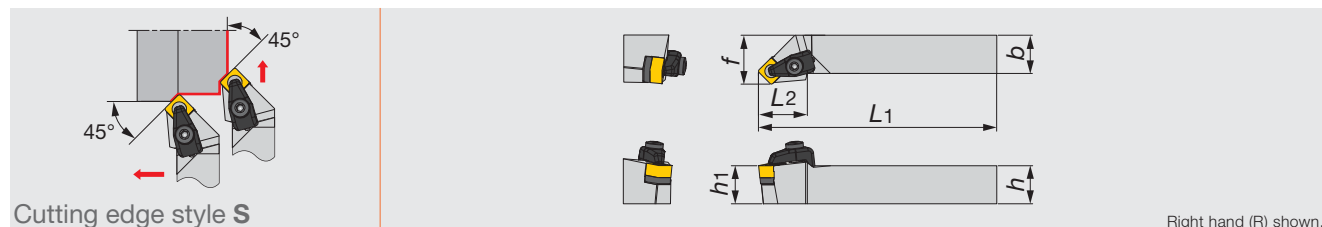

Inch	<i>h</i>	<i>b</i>	<i>L</i> ₁	<i>L</i> ₂	<i>h</i> ₁	<i>f</i>	<i>r</i> _ε **	Insert	Torque*
CSSNR/L16M45-RD	1.000	1.000	6.000	1.260	1.000	1.250	0.047	SNGD45...	3.0

*Torque: Recommended torque (lbf-ft) for clamping

**re: Standard corner radius

SPARE PARTS							
Designation	Clamp	Clamp screw	Shim	Shim screw	Spring	Wrench 1	Wrench 2
CSSNR/L16M45-RD	CCP4-A	CCS4-A	CS44-A	BH5-10-A	BP-5-A	P-3	P-4

DIMPLEFX

CHSNR-RD

Double clamp toolholder for ceramic insert with dimple, 45° approach angle, for negative hexagonal inserts

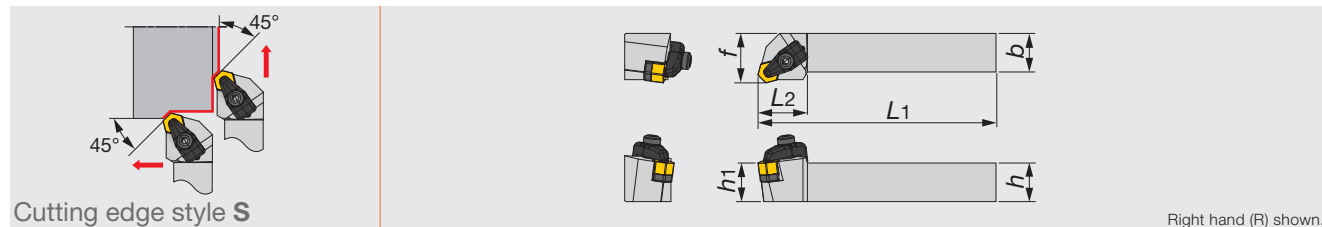

Inch	<i>h</i>	<i>b</i>	<i>L</i> ₁	<i>L</i> ₂	<i>h</i> ₁	<i>f</i>	<i>r</i> _ε **	Insert	Torque*
CHSNR16M45-RD	1.000	1.000	6.000	1.260	1.000	1.250	0.047	HNGD45...	3.0

*Torque: Recommended torque (lbf-ft) for clamping

**re: Standard corner radius

SPARE PARTS							
Designation	Clamp	Clamp screw	Shim	Shim screw	Spring	Wrench 1	Wrench 2
CHSNR16M45-RD	CCP4-A	CCS4-A	CH44-A	BH-40050-A	BP-5-A	P-3	P-4

Reference pages





CSSNR/L-RD: Inserts → **B081**, Standard cutting conditions → **B274**

CHSNR-RD: Inserts → **B105**, Standard cutting conditions → **B274**



Parts for C-type



Toolholders Designation	Applicable Insert Designation		Clamp	Clamp screw	Shim	Shim screw	Spring	Wrench	
CCLNR16M45-RD	CNGD45		CCP4-A	BH5-10-A	CC44-A	CCS4-A	BP-5-A	P4, P3	
CCLNL16M45-RD					CD44-A				
CDJNR16M45-RD	DNGD45				CD44-A				
CDJNL16M45-RD					CS44-A				
CDNNN16M45-RD					CV34-A				
CSSNR16M45-RD	SNGD45				BH-4-10-A				CV34-A
CSSNL16M45-RD					BH-40050-A				CH44-A
CVVNN16M35-RD	VNGD35								
CHSNR16M45-RD	HNGD45								

STANDARD CUTTING CONDITIONS

ISO	Workpiece material	Grade	Cutting speed Vc (sfm)	Depth of cut ap (in)	Feed f (ipr)
K	Grey cast irons	FX105	2300 (1000 - 3300)	0.040 (0.002 - 0.120)	0.012 (0.002 - 0.024)
	Ductile cast irons	FX105	650 (330 - 1000)	0.040 (0.002 - 0.120)	0.008 (0.002 - 0.016)

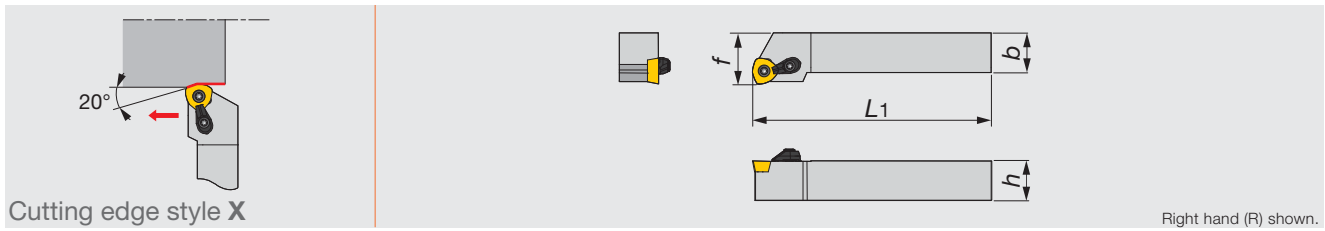

Inch	h	b	L1	f	Insert
XWXPR/L16-09	1.000	1.000	6.000	1.250	WPMT090725ZPR/L-ML
XWXPR/L20-09	1.250	1.250	7.000	1.500	WPMT090725ZPR/L-ML
XWXPR/L24-09	1.500	1.500	7.000	2.000	WPMT090725ZPR/L-ML

Note: Care should be taken not to confuse the hand of inserts to be used.

SPARE PARTS			
Designation	Clamp set	Clamping screw	Wrench
XWXPR/L...	CSY-20	CSPB-5	IP-20T

INSERT

WPMT09-ML



Material	Steel	Stainless	Cast iron	Non-ferrous	Superalloys	Hard materials
P	●●●*	●●	●●			
M		●●	●●			
K	●●	●●				
N						
S		●●				
H						

- : Continuous cutting
- : Light interrupted cutting
- * : Heavy interrupted cutting

Application	Chipbreaker	Designation	Corner radius	Coated																
				T9115	T9125	AH120														
Heavy		WPMT090725ZPR-ML	0.098	●	●	●														
		WPMT090725ZPL-ML	0.098	●	●	●														

● : Line up

STANDARD CUTTING CONDITIONS

ISO	Workpiece material	Grade	Chipbreaker	Cutting speed: Vc (sfm)	Depth of cut: ap (in)	Feed: f (ipr)
P	Mild and low carbon steels 400SS, 1025, etc. < 180 HB	T9125	ML	500 (330 - 830)	0.060 (0.020 - 0.100)	0.060 (0.020 - 0.100)
	Carbon and alloy steels 1049, 4142, etc. < 300HB	T9115	ML	500 (330 - 830)	0.060 (0.020 - 0.100)	0.060 (0.020 - 0.100)
M	Stainless steels 304, 316, etc. < 250 HB	T9125	ML	500 (330 - 830)	0.060 (0.020 - 0.100)	0.060 (0.020 - 0.100)
K	Gray and ductile cast irons No35B, 60-40-18, etc.	AH120	ML	500 (330 - 830)	0.060 (0.020 - 0.100)	0.060 (0.020 - 0.100)

Note: When the side cutting edge is used for facing, the maximum feed is limited to within 0.039 ipr.





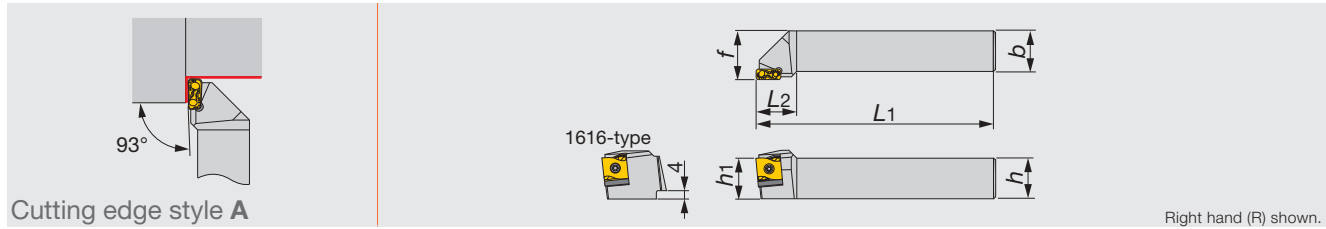



Screw-on clamp toolholder for roughing operation with 93° approach angle, for negative tangential inserts



Inch	<i>h</i>	<i>b</i>	<i>L1</i>	<i>L2</i>	<i>h1</i>	<i>f</i>	Insert
TLANR/L10-12	0.625	0.625	4.000	0.790	0.625	0.750	LNMX1204**R/L...
TLANR/L12-12	0.750	0.750	4.500	0.790	0.750	1.000	LNMX1204**R/L...
TLANR/L12-16	0.750	0.750	4.500	1.000	0.750	1.000	LNMX1606**R/L...
TLANR/L16-12	1.000	1.000	6.000	0.790	1.000	1.250	LNMX1204**R/L...
TLANR/L16-16	1.000	1.000	6.000	1.000	1.000	1.180	LNMX1606**R/L...
TLANR/L20-16	1.250	1.250	6.000	1.380	1.250	1.460	LNMX1606**R/L...
TLANR/L20-24	1.250	1.250	6.000	1.380	1.250	1.500	LNMX2410**R/L...
TLANR/L24-16	1.500	1.500	7.000	1.380	1.500	1.700	LNMX1606**R/L...
TLANR/L24-24	1.500	1.500	7.000	1.380	1.500	1.700	LNMX2410**R/L...
TLANR/L32-24	2.000	2.000	8.000	1.380	2.000	2.275	LNMX2410**R/L...

SPARE PARTS

Designation	 Clamping screw	 Shim screw	 Shim	 Spring	 Wrench 1	 Wrench 2
TLANR**-12	CSTB-3.5L115-S	CSTF-2L055-S	TSL12R	-	KEYV-T10	T-6F-S
TLANL**-12	CSTB-3.5L115-S	CSTF-2L055-S	TSL12L	-	KEYV-T10	T-6F-S
TLANR**-16	CSTB-4L115-S	-	TSL16R	PSP-16	KEYV-T15	-
TLANL**-16	CSTB-4L115-S	-	TSL16L	PSP-16	KEYV-T15	-
TLANR**-24	CSTB-5L163-S	-	TSL24R	PSP-16	KEYV-T20	-
TLANL**-24	CSTB-5L163-S	-	TSL24L	PSP-16	KEYV-T20	-

Reference pages

TLANR/L: Inserts → **B278**, Standard cutting conditions → **B279**

Screw-on clamp toolholder for roughing operation with 75° approach angle, for negative tangential inserts

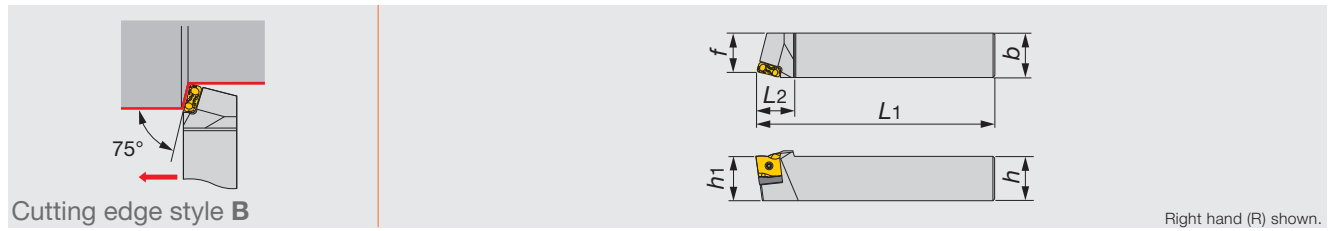

Inch	h	b	L1	L2	h1	f	Insert
TLBNR/L24-24	1.500	1.500	8.000	1.380	1.500	1.380	LNMX2410**R/L...

SPARE PARTS				
Designation	Clamping screw	Shim	Spring pin	Wrench
TLBNR24-24	CSTB-5L163-S	TSL24R	PSP-16	KEYV-T20
TLBNL24-24	CSTB-5L163-S	TSL24L	PSP-16	KEYV-T20

Screw-on clamp toolholder for roughing operation with 93° approach angle, for negative tangential inserts

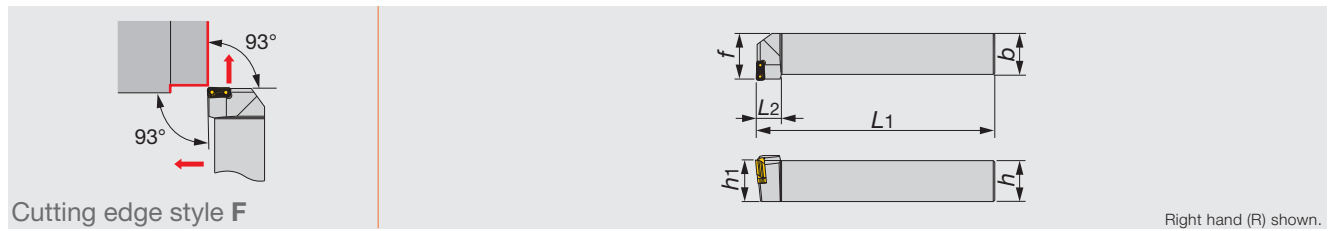

Inch	h	b	L1	L2	h1	f	Insert
TLFNR/L16-16	1.000	1.000	6.000	0.780	1.000	1.000	LNMX1606**L/R...
TLFNR/L20-16	1.250	1.300	6.000	0.780	1.250	1.000	LNMX1606**L/R...

Note: The right hand insert (R) is used for the left hand toolholders (TLFNL** type), and the left hand insert (L) is used for the right hand toolholders (TLFNR** type).

SPARE PARTS				
Designation	Clamping screw	Shim	Spring pin	Wrench
TLFNR16-16	CSTB-4L115-S	TSL16L	PSP-16	KEYV-T15
TLFNL16-16	CSTB-4L115-S	TSL16R	PSP-16	KEYV-T15
TLFNR20-16	CSTB-4L115-S	TSL16L	PSP-16	KEYV-T15
TLFNL20-16	CSTB-4L115-S	TSL16R	PSP-16	KEYV-T15

Reference pages

TLBNR/L, TLFNR/L: Inserts → B278, Standard cutting conditions → B279



TURANTEC

S-TLANR/L

Screw-on clamp toolholder for roughing operation with 91° approach angle, for negative tangential inserts

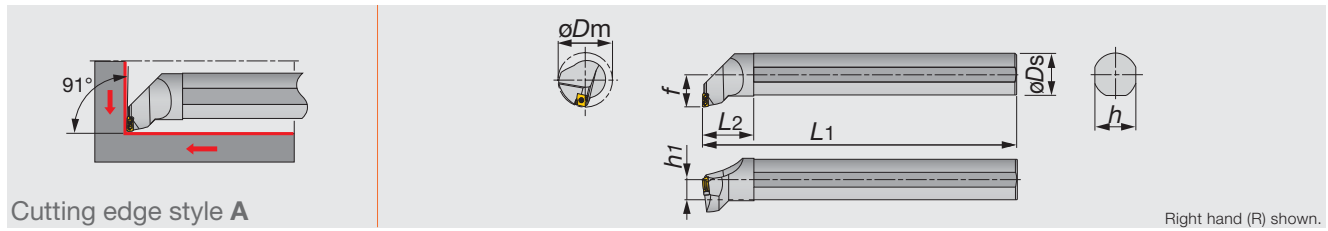

Inch	Material	ϕD_m	ϕD_s	f	L_1	L_2	h	h_1	Insert
S16-TLANR/L12-D34	Steel	2.090	1.000	0.670	12.000	1.500	0.920	0.460	LNMX1204**L/R...
S20-TLANR/L12-D34	Steel	2.090	1.250	0.870	14.000	1.750	1.140	0.570	LNMX1204**L/R...
S24-TLANR/L12-D34	Steel	2.090	1.500	1.060	16.000	2.000	1.340	0.670	LNMX1204**L/R...
S32-TLANR/L16-D54	Steel	3.350	2.000	1.460	16.000	2.360	1.810	0.905	LNMX1606**L/R...

Note: The right hand insert (R) is used for the left hand toolholders (TLANL** type), and the left hand insert (L) is used for the right hand toolholders (TLANR** type).

SPARE PARTS						
Designation	Clamping screw	Shim screw	Shim	Spring pin	Wrench 1	Wrench 2
S*-TLANR/L12-D34	CSTB-3.5L115-S	CSTF-2L055-S	TSL12L/RI	-	KEYV-T10	T-6F-S
S32-TLANR16-D54	CSTB-4L115-S	-	TSL16LI	PSP-16	KEYV-T15	-
S32-TLANL16-D54	CSTB-4L115-S	-	TSL16RI	PSP-16	KEYV-T15	-

INSERT

LNMX12/16/24

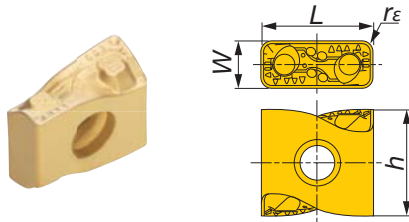

Designation	r_ϵ	Coated						W	L	h
		T9115		T9125		AH725				
		R	L	R	L	R	L			
LNMX120408R/L-TDR	0.031	●	●	●	●			0.189	0.473	0.457
LNMX120412R/L-TDR	0.047	●	●	●	●			0.189	0.473	0.457
LNMX160608R/L-TDR	0.031	●	●	●	●			0.252	0.638	0.532
LNMX160612R/L-TDR	0.047	●	●	●	●			0.252	0.638	0.532
LNMX160616R/L-TDR	0.063	●	●	●	●			0.252	0.638	0.532
LNMX241016R/L-TDR	0.063	●	●	●	●			0.370	0.945	0.807
LNMX241024R/L-TDR	0.094	●	●	●	●			0.370	0.945	0.807
LNMX160608R/L-MDR	0.031	●	●			●	●	0.252	0.638	0.532
LNMX160612R/L-MDR	0.047	●	●			●	●	0.252	0.638	0.532
LNMX160608R/L-TWR	0.031	●	●	●	●			0.252	0.638	0.532
LNMX160612R/L-TWR	0.047	●	●	●	●			0.252	0.638	0.532

● : Line up

Reference pages

Standard cutting conditions → **B279**

STANDARD CUTTING CONDITIONS

LNMX1204

* Values in red shows the condition for facing

ISO	Workpiece material	Chip-breaker	Grade	Cutting speed Vc (sfm)	Depth of cut: ap (in)		Feed: f (ipr)	
					r _E : 0.031	r _E : 0.047	r _E : 0.031	r _E : 0.047
P	Steels 1045, 4130, etc.	TDR	T9115	390 - 820	0.020 - 0.195 0.020 - 0.086	0.031 - 0.195 0.031 - 0.086	0.006 - 0.024	0.010 - .031
		TDR	T9125	260 - 590	0.020 - 0.195 0.020 - 0.086	0.031 - 0.195 0.031 - 0.086	0.006 - 0.024	0.010 - .031
M	Stainless steels 304, 316, etc.	TDR	T9115	330 - 590	0.020 - 0.195 0.020 - .086	0.031 - 0.195 0.031 - 0.086	0.006 - 0.024	0.010 - .031
		TDR	T9125	260 - 590	0.020 - 0.195 0.020 - 0.086	0.031 - 0.195 0.031 - 0.086	0.006 - 0.024	0.010 - .031

LNMX1606

ISO	Workpiece material	Chip-breaker	Grade	Cutting speed Vc (sfm)	Depth of cut: ap (in)			Feed: f (ipr)		
					r _E : 0.031	r _E : 0.047	r _E : 0.063	r _E : 0.031	r _E : 0.047	r _E : 0.063
P	Steels 1045, 4130, etc.	TDR	T9115	390 - 820	0.020 - 0.197 0.020 - .126	0.031 - 0.236 .031 - .126	0.039 - 0.315 0.039 - 0.126	0.006 - 0.024	0.010 - 0.031	0.012 - 0.039
		TDR	T9125	260 - 590	0.020 - 0.197 0.020 - .126	0.031 - 0.236 .031 - .126	0.039 - 0.315 0.039 - 0.126	0.006 - 0.024	0.010 - 0.031	0.012 - 0.039
		TWR	T9115	390 - 820	0.020 - 0.197 0.020 - 0.126	0.031 - 0.236 0.031 - 0.126	-	0.006 - 0.024	0.010 - 0.031	-
		TWR	T9125	260 - 590	0.020 - 0.197 0.020 - 0.126	0.031 - 0.236 0.031 - 0.126	-	0.006 - 0.024	0.010 - 0.031	-
M	Stainless steels 304, 316, etc.	TDR	T9115	330 - 590	0.020 - 0.197 0.020 - 0.126	0.031 - 0.236 0.031 - 0.126	0.039 - 0.315 0.039 - 0.126	0.006 - 0.024	0.010 - 0.031	0.012 - 0.039
		TDR	T9125	260 - 590	0.020 - 0.197 0.020 - 0.126	0.031 - 0.236 0.031 - 0.126	0.039 - 0.315 0.039 - 0.126	0.006 - 0.024	0.010 - 0.031	0.012 - 0.039
		MDR	T9115	330 - 490	0.059 - 0.236 0.020 - 0.126	0.059 - 0.276 0.031 - 0.126	-	0.004 - 0.020	0.006 - 0.028	-
		MDR	AH725	160 - 490	0.059 - 0.236 0.020 - 0.126	0.059 - 0.276 0.031 - 0.126	-	0.004 - 0.020	0.006 - 0.028	-
		TWR	T9115	330 - 590	0.020 - 0.197 0.020 - 0.126	0.031 - 0.236 0.031 - 0.126	-	0.006 - 0.024	0.010 - 0.031	-
		TWR	T9125	260 - 590	0.020 - 0.197 0.020 - 0.126	0.031 - 0.236 0.031 - 0.126	-	0.006 - 0.024	0.010 - 0.031	-

LNMX2410

ISO	Workpiece material	Chip-breaker	Grade	Cutting speed Vc (sfm)	Depth of cut: ap (in)		Feed: f (ipr)	
					r _E : 0.063	r _E : 0.094	r _E : 0.063	r _E : 0.094
P	Steels 1045, 4130, etc.	TDR	T9115	390 - 820	0.156 - 0.585 0.039 - 0.176	0.195 - 0.585 0.039 - 0.176	0.012 - 0.039	0.012 - 0.043
		TDR	T9125	260 - 490	0.156 - 0.585 0.039 - 0.176	0.195 - 0.585 0.039 - 0.176	0.012 - 0.039	0.012 - 0.043
M	Stainless steels 304, 316, etc.	TDR	T9115	330 - 590	0.156 - 0.585 0.039 - 0.176	0.195 - 0.585 0.039 - 0.176	0.012 - 0.039	0.012 - 0.043
		TDR	T9125	260 - 490	0.156 - 0.585 0.039 - 0.176	0.195 - 0.585 0.039 - 0.176	0.012 - 0.039	0.012 - 0.043



Ext. Toolholder

TurnLine - Internal Toolholder

			Inch	Metric
	MINIFORCE Economical double-sided inserts with excellent sharpness  Shank ϕ 0.375 - 1.000"	<u>B288</u>	<input checked="" type="checkbox"/>	<input type="checkbox"/>
	ISO Eco Small-sized "Eco" insert series for maximized profits  Shank ϕ 1.000 - 1.250" (ϕ 16 - 32 mm)	<u>B294</u>	<input checked="" type="checkbox"/>	<input checked="" type="checkbox"/>
	STREAMJETBAR Highly rigid toolholders providing good chip evacuation  Shank ϕ 0.157 - 1.000" (ϕ 4 - 50 mm)	<u>B299</u>	<input checked="" type="checkbox"/>	<input checked="" type="checkbox"/>
	TURNINGA Highly rigid clamping system with excellent repeatability  Shank ϕ 1.000 - 2.000"	<u>B326</u>	<input checked="" type="checkbox"/>	<input type="checkbox"/>
	Y-PRO SERIES Inserts with 25° corner angle for profiling  Shank ϕ 0.500 - 0.625" (ϕ 12 - 16 mm)	<u>B329</u>	<input checked="" type="checkbox"/>	<input checked="" type="checkbox"/>
	ISO-Turn Internal Toolholders for general internal turning 	<u>B330</u>	<input type="checkbox"/>	<input checked="" type="checkbox"/>

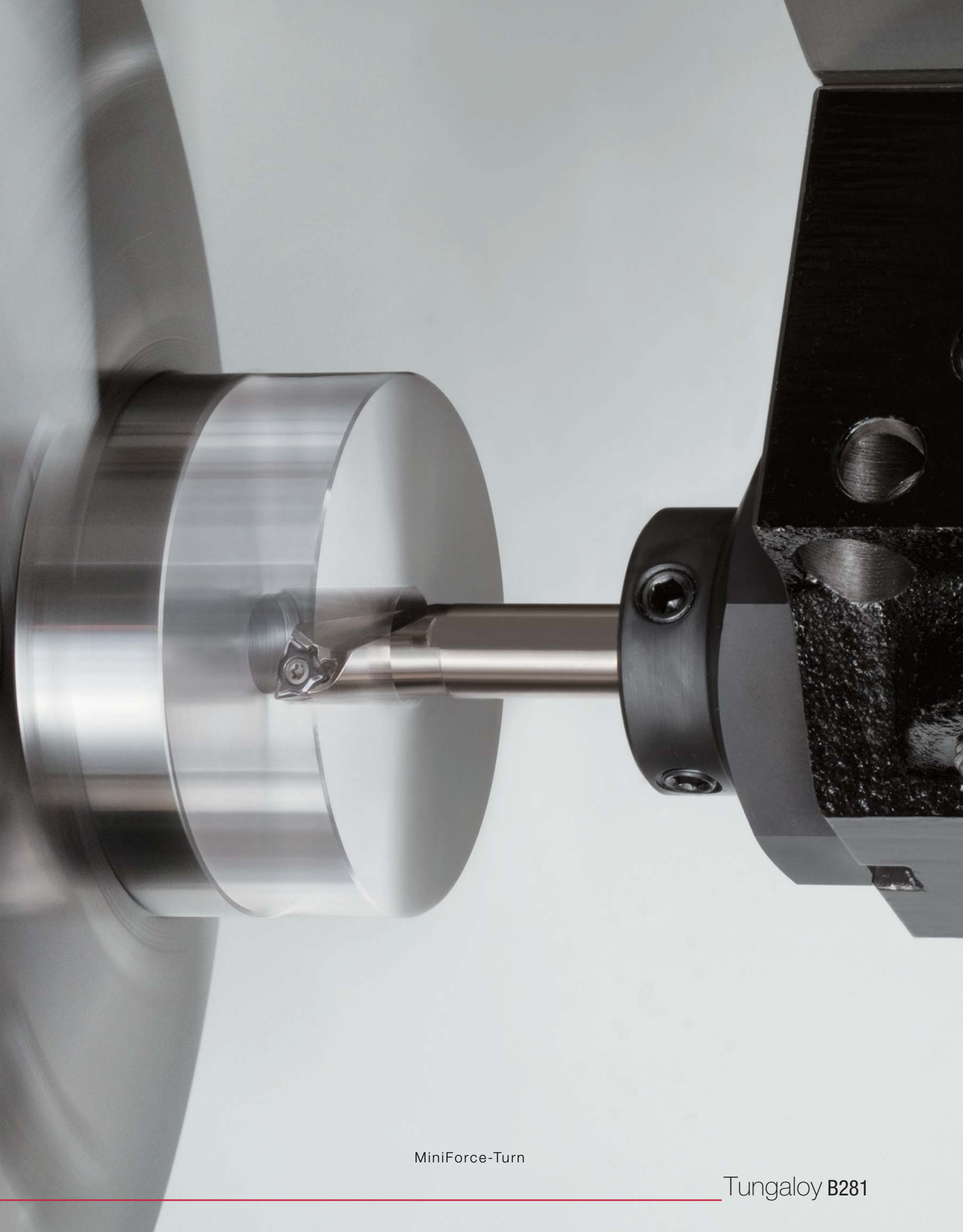







MiniForce-Turn

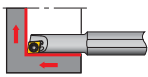
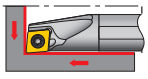
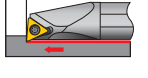

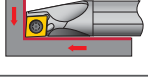
Tungaloy B281

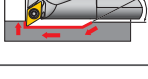
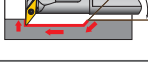
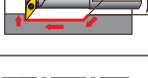
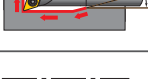
Internal Toolholder - Quick Guide

Positive type Inch

Style	StreamJet-Bar Description & Application	ISO Insert	Y-Pro	Shank Type	Shank Ø	Min. bore diameter (in)					See page
						0	0.375	0.750	1.125	1.500	
	SEXPR/L Boring & internal facing Insert type: EP□□	✓		Steel Carbide	ø0.157 - ø0.313 ø0.157 - ø0.313	ø0.250					B302
	SCLCR/L Boring & internal facing Insert type: CC□□	✓		Steel Carbide	ø0.375 - ø1.000 ø0.375 - ø1.000	ø0.500	ø1.280		ø1.250		B299 B301
	STUPR/L Boring Insert type: TP□□	✓		Steel Carbide	ø0.313 - ø1.000 ø0.313 - ø0.625	ø0.438	ø1.250		ø0.875		B310
	STFPR/L Blind hole boring Insert type: TP□□	✓		Carbide	ø0.375 - ø0.750	ø0.500	ø1.000				B309
	SCLPR/L Boring & internal facing Insert type: CP□□	✓		Steel Carbide	ø0.375 - ø0.625 ø0.375 - ø0.625	ø0.500	ø0.875		ø0.875		B303
	STFCR/L Blind hole boring Insert type: TC□□	✓		Carbide	ø0.375 - ø0.750	ø0.430	ø0.930				B308
	SDUCR/L Boring & internal profiling Insert type: DC□□	✓		Steel Carbide	ø0.375 - ø0.750 ø0.375 - ø0.750	ø0.625	ø1.000		ø1.000		B313
	SVUCR/L Boring & internal profiling Insert type: VC□□	✓		Steel	ø0.625 - ø0.750	ø0.875		ø1.000			B315
	SVUBR/L Boring & internal profiling Insert type: VB□□	✓		Steel	ø0.750			ø1.000			B314
	SDQCR/L Boring & internal profiling Insert type: DC□□	✓		Steel	ø0.375 - ø0.625	ø0.625	ø0.875				B316
	SVQCR/L Boring & internal profiling Insert type: VC□□	✓		Steel	ø0.500 - ø0.625	ø0.688		ø1.000			B318
	SVQBR/L Boring & internal profiling Insert type: VB□□	✓		Steel	ø0.625			ø1.000			B317

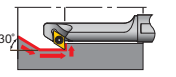
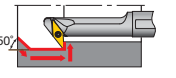
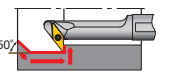
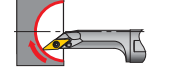
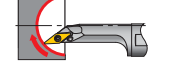
Int. Toolholder

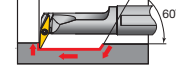



Style	StreamJet-Bar Description & Application	ISO Insert	Y-Pro	Shank Type	Shank Ø	Min. bore diameter (in)					See page
						0	0.375	0.750	1.125	1.500	
	SDZCR/L Internal retracting Insert type: DC□□	✓		Steel	ø0.625					ø0.875	B319
	SVZCR/L Internal retracting Insert type: VC□□	✓		Steel	ø0.500 - ø0.750		ø0.750			ø1.000	B320
	SVZBR/L Internal retracting Insert type: VB□□	✓		Steel	ø0.750					ø1.000	B320
	SVJCR/L Internal sphere cutting Insert type: VC□□	✓		Steel	ø0.625					ø1.000	B306
	SVJBR/L Internal sphere cutting Insert type: VB□□	✓		Steel	ø0.625					ø1.000	B306
	SYQBR/L Internal undercut & profiling Insert type: YW□□	✓		Steel Carbide	ø0.500 - ø0.625 ø0.500 - ø0.625	ø0.750		ø0.875		ø0.875	B329
	SYUBR/L Boring & internal profiling Insert type: YW□□	✓		Steel Carbide	ø0.625 ø0.500 - ø0.625					ø1.000 ø0.875 ø1.000	B329

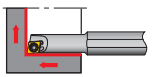

Int. Toolholder

Internal Toolholder - Quick Guide

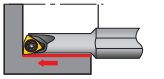
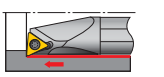
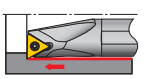
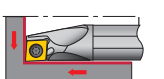
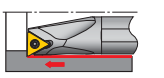
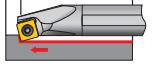
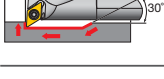
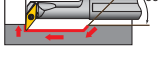
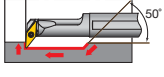
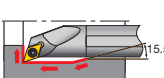
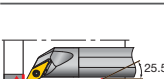
Positive type Metric

Style	StreamJet-Bar Description & Application	ISO Insert	Y-Pro	Shank Type	Shank Ø	Min. bore diameter (mm)					See page	
						0	10	20	30	40		50
	SEXPR/L Boring & internal facing Insert type: EP□□	✓		Steel	Ø4 - Ø8	Ø4.5	Ø7					B302 B305
	SCLCR/L Boring & internal facing Insert type: CC□□	✓		Steel	Ø4 - Ø25	Ø5	Ø27					B300 B330
				Carbide	Ø4 - Ø25	Ø5	Ø27					
				Reinforced	Ø12 - Ø25		Ø16	Ø32				
	SWUBR/L Boring Insert type: WB□□	✓		Steel	Ø5 - Ø8	Ø6	Ø8					B312
				Carbide	Ø5 - Ø8	Ø6	Ø8					
	STUPR/L Boring Insert type: TP□□	✓		Steel	Ø7 - Ø32	Ø8	Ø34					B311 B331
				Carbide	Ø7 - Ø25	Ø8	Ø27					
				Reinforced	Ø12 - Ø25	Ø14	Ø31					
	STFPR/L Blind hole boring Insert type: TP□□	✓		Steel	Ø8 - Ø25	Ø10	Ø27					B309
				Carbide	Ø8 - Ø20	Ø10	Ø22					
	SCLPR/L Boring & internal facing Insert type: CP□□	✓		Steel	Ø8 - Ø25	Ø10	Ø27					B304 B330
				Carbide	Ø8 - Ø16	Ø10	Ø20					
				Reinforced	Ø12 - Ø25	Ø14	Ø32					
	STFCR/L Blind hole boring Insert type: TC□□	✓		Steel	Ø10 - Ø16	Ø12	Ø18					B308
				Carbide	Ø10 - Ø16	Ø12	Ø18					
	SSKPR Through boring Insert type: SP□□	✓		Steel	Ø16 - Ø25		Ø20	Ø31				B307
	SDUCR/L Boring & internal profiling Insert type: DC□□	✓		Steel	Ø10 - Ø25	Ø13	Ø32					B313
				Carbide	Ø10 - Ø20	Ø13	Ø27					
	SVUCR/L Boring & internal profiling Insert type: VC□□	✓		Steel	Ø12 - Ø25	Ø16	Ø32					B322
				Carbide	Ø12 - Ø25	Ø18	Ø32					
				Reinforced	Ø25		Ø32					
	SVUBR/L Boring & internal profiling Insert type: VB□□	✓		Steel	Ø16 - Ø25		Ø20	Ø32				B332
				Carbide	Ø16 - Ø25		Ø24.5	Ø34				
				Reinforced	Ø20		Ø25					
	SDQCR/L Boring & internal profiling Insert type: DC□□	✓		Steel	Ø10 - Ø25	Ø13	Ø30					B316 B333
				Carbide	Ø10 - Ø20	Ø13	Ø25					
				Reinforced	Ø16 - Ø25	Ø20	Ø32					
	SVQCR/L Boring & internal profiling Insert type: VC□□	✓		Steel	Ø10 - Ø16	Ø13.5	Ø21.5					B318 B334
				Carbide	Ø10 - Ø16	Ø13.5	Ø21.5					
				Reinforced	Ø25		Ø32					
	SVQBR/L Boring & internal profiling Insert type: VB□□	✓		Steel	Ø12 - Ø25	Ø17	Ø30.5					B334
				Carbide	Ø12 - Ø25	Ø17	Ø30.5					
				Reinforced	Ø20	Ø25						

Int. Toolholder



Int. Toolholder

Style	StreamJet-Bar Description & Application	ISO Insert	Y-Pro	Shank Type	Shank Ø	Min. bore diameter (mm)						See page
						0	10	20	30	40	50	
	SDZCR/L Internal retracting Insert type: DC□□	✓		Steel	Ø12 - Ø25	Ø14					Ø25	B319
				Carbide	Ø12 - Ø16			Ø18			Ø22	
	SVZCR/L Internal retracting Insert type: VC□□	✓		Steel	Ø12			Ø16				B320
	SVZBR/L Internal retracting Insert type: VB□□	✓		Steel	Ø16 - Ø32			Ø20			Ø40	B320
	SEZPR/L Internal retracting Insert type: EP□□	✓		Steel	Ø4 - Ø5	Ø5.5		Ø6.5				B321
				Carbide	Ø4 - Ø5	Ø5.5		Ø6.5				
	SVJCR/L Internal sphere cutting Insert type: VC□□	✓		Steel	Ø12 - Ø16			Ø16			Ø20	B306
	SVJBR/L Internal sphere cutting Insert type: VB□□	✓		Steel	Ø20 - Ø25			Ø25			Ø30	B306
	SYQBR/L Internal undercut & profiling Insert type: YW□□	✓		Steel	Ø12 - Ø16			Ø17			Ø21.5	B329
				Carbide	Ø12 - Ø16			Ø17			Ø21.5	
	SYUBR/L Boring & internal profiling Insert type: YW□□	✓		Steel	Ø16			Ø20				B329
				Carbide	Ø12 - Ø16			Ø20			Ø24.5	

Clamp-on

Metric

Style	Description & Application	ISO insert	Shank Type	Shank Ø	Min. bore diameter (mm)						See page	
					0	10	20	30	40	50		
	CTFPR/L Blind hole boring Insert type: TP□□ (Without hole)	✓		Steel	Ø12 - Ø32			Ø16			Ø40	B335
				Carbide	Ø12 - Ø16			Ø16			Ø20	
	CSKPR/L Through boring Insert type: SP□□ (Without hole)	✓		Steel	Ø16 - Ø25			Ø20			Ø32	B335

Internal Toolholder - Quick Guide

MiniForce-Turn - Double-sided insert with positive cutting edges

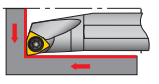
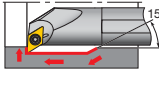
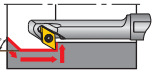
Inch	Style	MiniForce-Turn Description & Application	MiniForce-Turn	Shank Type	Shank Ø	Min. bore diameter (in)					See page
						0	0.375	0.750	1.125	1.500	
		SWLXR/L Boring & facing Insert type: WXGU	✓	Steel	ø0.375 - ø1.000	ø0.500				ø1.250	B288
				Carbide	ø0.375 - ø1.000	ø0.500				ø1.250	
		SDXXR/L Internal profiling Insert type: DXGU	✓	Steel	ø0.375 - ø1.000	ø0.625				ø1.250	B288
				Carbide	ø0.375 - ø1.000	ø0.625				ø1.250	
		SDZXR/L Internal retracting Insert type: DXGU	✓	Steel	ø0.500 - ø0.750	ø0.625		ø0.875			B289

Int. Toolholder

Negative type

Double-clamp

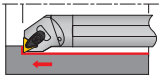
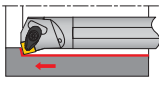
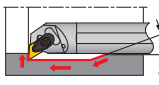
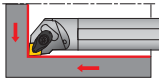
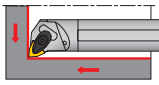
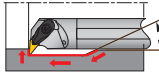
Inch	Style	Turning A Description & Application	ISO insert	ISO-EcoTurn	Shank Type	Shank Ø	Min. bore diameter (in)					See page
							0.750	1.125	1.500	2.000	2.500	
		ATFNR/L Boring Insert type: TN□□	✓		Steel	ø1.000-ø1.250	ø1.250			ø1.560		B327
		ASKNR/L Boring Insert type: SN□□	✓		Steel	ø1.000-ø1.250	ø1.250			ø1.560		B327
		ADUNR/L Boring & internal profiling Insert type: DN□□	✓	✓	Steel	ø1.000-ø1.500	ø1.250			ø2.000		B296 B328
		ACLNR/L Boring & internal facing Insert type: CN□□, GN□□	✓	✓	Steel	ø1.000-ø2.000	ø1.250			ø2.500		B294 B326
		AWLNR/L Boring & internal facing Insert type: WN□□	✓	✓	Steel	ø1.000-ø2.000	ø1.250			ø2.500		B295 B326
		AVUNR/L Boring & internal profiling Insert type: VN□□	✓		Steel	ø1.250-ø1.500		ø1.560		ø2.000		B328

Lever-lock

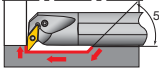
Inch	Style	StreamJet-Bar Description & Application	ISO insert	ISO-EcoTurn	Shank Type	Shank Ø	Min. bore diameter (in)					See page
							0.750	1.125	1.500	2.000	2.500	
		PVUNR/L Boring & internal profiling Insert type: VN□□	✓	✓	Steel	ø1.250-ø1.650	ø1.000			ø1.250		B298

Lever-lock

Metric	Style	StreamJet-Bar Description & Application	ISO insert	ISO-EcoTurn	Shank Type	Shank Ø	Min. bore diameter (mm)						See page
							20	30	40	50	60	70	
		PTUNR/L Boring Insert type: TN□□	✓	✓	Steel	Ø16 - Ø32	Ø20		Ø40				B297 B324 B339 B340
							Reinforced	Ø16 - Ø50	Ø20			Ø63	
		PTFNR/L Boring Insert type: TN□□	✓	✓	Steel	Ø25 - Ø50	Ø32				Ø63		B296 B323 B338
		PSKNR/L Through boring Insert type: SN□□	✓		Steel	Ø32 - Ø50		Ø40			Ø63		B322 B337
		PDUNR/L Internal profiling Insert type: DN□□	✓	✓	Steel	Ø20 - Ø50	Ø25				Ø63		B297 B324 B338 B339 B347
							Reinforced	Ø32 - Ø50		Ø40		Ø63	
		PCLNR/L Boring & internal facing Insert type: CN□□, GN□□	✓	✓	Steel	Ø16 - Ø50	Ø20				Ø63		B294 B321 B336 B347
							Reinforced	Ø16 - Ø50	Ø20			Ø63	
		PWLNR/L Boring & facing Insert type: WN□□	✓	✓	Steel	Ø16 - Ø40	Ø20				Ø50		B295 B322 B337
		PVUNR/L Boring & internal profiling Insert type: VN□□	✓	✓	Steel	Ø25 - Ø40	Ø32				Ø50		B298 B325
		PDZNR/L Internal retracting Insert type: DN□□	✓		Steel	Ø32 - Ø50			Ø40		Ø63		B325 B340



Int. Toolholder

Multi-clamp

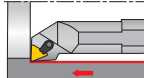
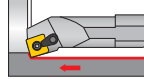
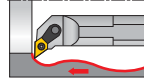
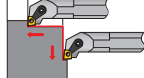
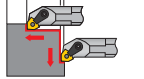
Metric	Style	Description & Application	ISO insert	Shank Type	Shank Ø	Min. bore diameter (mm)						See page	
						20	30	40	50	60	70		
		MTFNR/L Boring Insert type: TN□□	✓		Steel	Ø25	Ø32						B342
		MSKNR/L Through boring Insert type: SN□□	✓		Steel	Ø25	Ø32						B342
		MDUNR/L Boring & internal profiling Insert type: DN□□	✓		Steel	Ø25	Ø32						B343
		MCLNR/L Boring & internal facing Insert type: CN□□, GN□□	✓		Steel	Ø25	Ø32						B341
		MWLNR/L Boring & internal facing Insert type: WN□□	✓		Steel	Ø25 - Ø50	Ø32				Ø70		B341

MINIFORCE

A/E-SWLXR/L

For trigon insert with 6 edges

Int. Toolholder

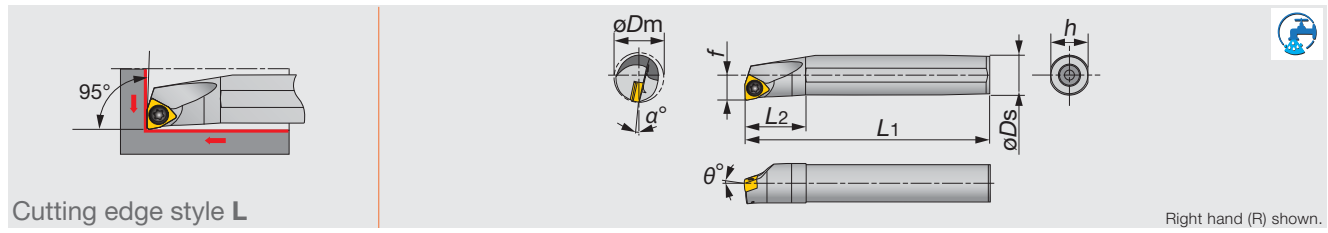

Inch	Material	øDm	øDs	f	L1	L2	h	θ°	α°	rε**	Insert	Torque*
A06-SWLXR/L2-D08	STEEL	0.500	0.375	0.281	5.000	0.750	0.350	-10	-14	0.016	WXGU22**L/R...	0.66
A08-SWLXR/L2-D11	STEEL	0.688	0.500	0.406	5.000	1.000	0.475	-10	-10	0.016	WXGU22**L/R...	0.66
A10-SWLXR/L2-D14	STEEL	0.875	0.625	0.531	7.000	1.250	0.600	-10	-8	0.016	WXGU22**L/R...	0.66
A12-SWLXR/L2-D16	STEEL	1.000	0.750	0.593	7.000	1.438	0.725	-10	-7	0.016	WXGU22**L/R...	0.66
A16-SWLXR/L2-D20	STEEL	1.250	1.000	0.625	7.000	1.438	0.938	-10	-7	0.016	WXGU22**L/R...	0.66
E06-SWLXR/L2-D08	CARBIDE	0.500	0.375	0.281	5.000	1.000	0.350	-10	-14	0.016	WXGU22**L/R...	0.66
E08-SWLXR/L2-D11	CARBIDE	0.688	0.500	0.406	5.000	1.063	0.475	-10	-10	0.016	WXGU22**L/R...	0.66
E10-SWLXR/L2-D14	CARBIDE	0.875	0.625	0.531	7.000	1.250	0.600	-10	-8	0.016	WXGU22**L/R...	0.66
E12-SWLXR/L2-D16	CARBIDE	1.000	0.750	0.593	7.000	1.438	0.725	-10	-7	0.016	WXGU22**L/R...	0.66
E16-SWLXR/L2-D20	CARBIDE	1.250	1.000	0.625	10.000	1.812	0.938	-10	-7	0.016	WXGU22**L/R...	0.66

*Torque: Recommended torque (lbf-ft) for clamping **rε: Standard corner radius
 Note: Right hand toolholders (R) are used with left hand inserts (L) Left hand toolholders (L) are used with right hand inserts (R)

SPARE PARTS

Designation	Clamping screw	Wrench
A/E**-SWLXR/L...	SR34-514	T-7F

MINIFORCE

A/E-SDXXR/L

For 55° rhombic insert with 4 edges

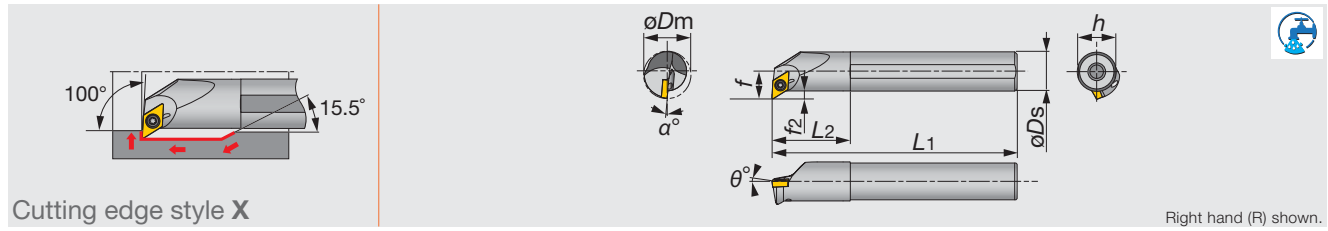

Inch	Material	øDm	øDs	f	L1	L2	h	f2	θ°	α°	rε**	Insert	Torque*
A06-SDXXR/L2-D10	STEEL	0.625	0.375	0.406	5.000	0.750	0.350	0.213	-14	-12	0.016	DXGU22**L/R...	0.66
A08-SDXXR/L2-D11	STEEL	0.688	0.500	0.406	5.000	1.000	0.475	0.151	-13.5	-11	0.016	DXGU22**L/R...	0.66
A10-SDXXR/L2-D14	STEEL	0.875	0.625	0.531	7.000	1.250	0.600	0.213	-13	-9	0.016	DXGU22**L/R...	0.66
A12-SDXXR/L2-D16	STEEL	1.000	0.750	0.593	7.000	1.438	0.725	0.213	-13	-8	0.016	DXGU22**L/R...	0.66
A16-SDXXR/L2-D20	STEEL	1.250	1.000	0.625	7.000	1.438	0.938	0.120	-13	-8	0.016	DXGU22**L/R...	0.66
E06-SDXXR/L2-D10	CARBIDE	0.625	0.375	0.406	5.000	1.000	0.350	0.213	-14	-12	0.016	DXGU22**L/R...	0.66
E08-SDXXR/L2-D11	CARBIDE	0.688	0.500	0.406	5.000	1.063	0.475	0.151	-13.5	-11	0.016	DXGU22**L/R...	0.66
E10-SDXXR/L2-D14	CARBIDE	0.875	0.625	0.531	7.000	1.250	0.600	0.213	-13	-9	0.016	DXGU22**L/R...	0.66
E12-SDXXR/L2-D16	CARBIDE	1.000	0.750	0.593	7.000	1.438	0.725	0.213	-13	-8	0.016	DXGU22**L/R...	0.66
E16-SDXXR2-D20	CARBIDE	1.250	1.000	0.625	10.000	1.812	0.938	0.120	-13	-8	0.016	DXGU22**L/R...	0.66

*Torque: Recommended torque (lbf-ft) for clamping **rε: Standard corner radius
 Note: Right hand toolholders (R) are used with left hand inserts (L) Left hand toolholders (L) are used with right hand inserts (R)

SPARE PARTS

Designation	Clamping screw	Wrench
A/E**-SDXXR/L...	SR34-514	T-7F

Reference pages

A/E-SWLXR/L: Inserts → **B290**, Standard cutting conditions → **B293**

A/E-SDXXR/L: Inserts → **B291** -, Standard cutting conditions → **B293**

MINIFORCE A-SDZXR/L

For 55° rhombic insert with 4 edges

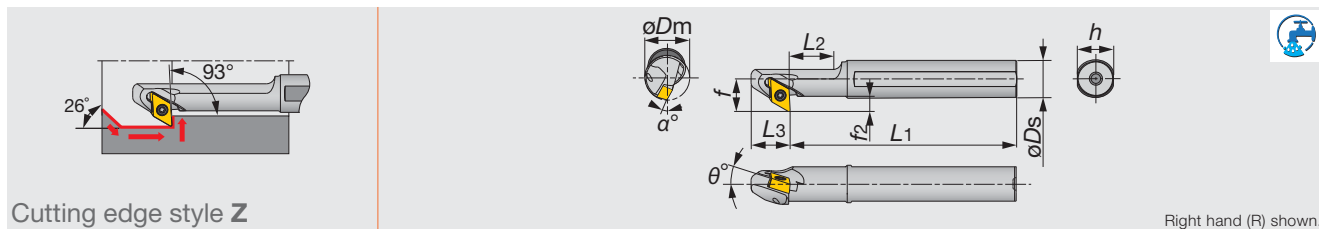

Cutting edge style Z

Right hand (R) shown.

Inch	Material	$\varnothing D_m$	$\varnothing D_s$	f	L_1	L_2	L_3	h	f_2	θ°	α°	r_ϵ^{**}	Insert	Torque*
A08-SDZXR/L2-D10	STEEL	0.625	0.500	0.438	5.000	1.125	0.500	0.475	0.188	-10	-14	0.016	DXGU22**R/L...	0.66
A10-SDZXR/L2-D11	STEEL	0.688	0.625	0.500	7.000	1.250	0.500	0.600	0.188	-10	-12.5	0.016	DXGU22**R/L...	0.66
A12-SDZXR/L2-D14	STEEL	0.875	0.750	0.563	7.000	1.375	0.500	0.725	0.188	-10	-10.5	0.016	DXGU22**R/L...	0.66

*Torque: Recommended torque (lbf-ft) for clamping ** r_ϵ : Standard corner radius

Note: Right hand toolholders (R) are used with right hand inserts (R) Left hand toolholders (L) are used with left hand inserts (L)

SPARE PARTS



Designation	Clamping screw	Wrench
A**-SDZXR/L...	SR34-514	T-7F



Int. Toolholder

Reference pages

A/E-SDZXR/L: Inserts → **B291** -, Standard cutting conditions → **B293**

- : Continuous cutting
- ◐ : Light interrupted cutting
- ✱ : Heavy interrupted cutting

INSERT

POSITIVE TYPE DOUBLE-SIDED



**Trigon, 80°
with hole**

	P	M	K	N	S	H
Steel	●	●	●	●	●	●
Stainless	●	●	●	●	●	●
Cast iron	●	●	●	●	●	●
Non-ferrous	●	●	●	●	●	●
Superalloys	●	●	●	●	●	●
Hard materials	●	●	●	●	●	●



Int. Toolholder

Application	Chipbreaker	Designation		Corner radius	Coated		Coated cermet	Cermet	Uncoated
		Inch	Metric		AH725	SH725	GT9530	NS9530	KS05F
Finishing to medium cutting (Sharp edge)		JTS	WXGU 220 MFR-JTS	WXGU040301MFR-JTS	<0.004**	●			
			WXGU 220 MFL-JTS	WXGU040301MFL-JTS	<0.004**	●			
			WXGU 220.5 MFR-JTS	WXGU040302MFR-JTS	<0.008**	●			
			WXGU 220.5 MFL-JTS	WXGU040302MFL-JTS	<0.008**	●			
Finishing to medium cutting		JTS	WXGU 220 MR-JTS	WXGU040301MR-JTS	<0.004**	●			
			WXGU 220 ML-JTS	WXGU040301ML-JTS	<0.004**	●			
			WXGU 220.5 MR-JTS	WXGU040302MR-JTS	<0.008**	●			
			WXGU 220.5 ML-JTS	WXGU040302ML-JTS	<0.008**	●			
Finishing (Low cutting force) (Sharp edge)		JSS	WXGU 220 MFR-JSS	WXGU040301MFR-JSS	<0.004**	●			
			WXGU 220 MFL-JSS	WXGU040301MFL-JSS	<0.004**	●			
			WXGU 220.5 MFR-JSS	WXGU040302MFR-JSS	<0.008**	●			
			WXGU 220.5 MFL-JSS	WXGU040302MFL-JSS	<0.008**	●			
Finishing (Low cutting force)		JSS	WXGU 220 MR-JSS	WXGU040301MR-JSS	<0.004**	●			
			WXGU 220 ML-JSS	WXGU040301ML-JSS	<0.004**	●			
			WXGU 220.5 MR-JSS	WXGU040302MR-JSS	<0.008**	●			
			WXGU 220.5 ML-JSS	WXGU040302ML-JSS	<0.008**	●			
Finishing to medium cutting		TS	WXGU 220.5 R TS	WXGU040302R-TS	0.008"	●	●	●	●
			WXGU 220.5 L TS	WXGU040302L-TS	0.008"	●	●	●	●
			WXGU 221 R TS	WXGU040304R-TS	0.016"	●	●	●	●
			WXGU 221 L TS	WXGU040304L-TS	0.016"	●	●	●	●
			WXGU 222 R TS	WXGU040308R-TS	0.031"	●	●	●	●
			WXGU 222 L TS	WXGU040308L-TS	0.031"	●	●	●	●
Finishing (Wiper)		TSW	WXGU 221 R TSW	WXGU040304R-TSW	0.016"	●	●	●	
			WXGU 221 L TSW	WXGU040304L-TSW	0.016"	●	●	●	
			WXGU 222 R TSW	WXGU040308R-TSW	0.031"	●	●	●	
			WXGU 222 L TSW	WXGU040308L-TSW	0.031"	●	●	●	
Finishing (Low cutting force)		SS	WXGU 220.5 R SS	WXGU040302R-SS	0.008"	●	●	●	●
			WXGU 220.5 L SS	WXGU040302L-SS	0.008"	●	●	●	●
			WXGU 221 R SS	WXGU040304R-SS	0.016"	●	●	●	●
			WXGU 221 L SS	WXGU040304L-SS	0.016"	●	●	●	●

* Corner radius has minus tolerance.

● : Line up





INSERT

POSITIVE TYPE DOUBLE-SIDED

**Rhombic, 55°
with hole**

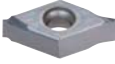
● : Continuous cutting
● : Light interrupted cutting
※ : Heavy interrupted cutting

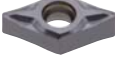
	P	M	K	N	S	H
Steel	●●●	●●●	●			
Stainless	●●●	●●●				
Cast iron	●		●			
Non-ferrous				●●●		
Superalloys					●	
Hard materials						●

Application	Chipbreaker	Designation		Corner radius	Coated																										
		Inch	Metric		AH725	SH725																									
Finishing (Sharp edge)		JRP	DXGU 220-MFRE-JRP	DXGU070301MFRE-JRP	<0.004**	●	●																								
			DXGU 220-MFLE-JRP	DXGU070301MFLE-JRP	<0.004**	●	●																								
			DXGU 220.5-MFRE-JRP	DXGU070302MFRE-JRP	<0.008**	●	●																								
			DXGU 220.5-MFLE-JRP	DXGU070302MFLE-JRP	<0.008**	●	●																								
Finishing to medium cutting (Sharp edge)		JTS	DXGU 220-MFR-JTS	DXGU070301MFR-JTS	<0.004**	●	●																								
			DXGU 220-MFL-JTS	DXGU070301MFL-JTS	<0.004**	●	●																								
			DXGU 220.5-MFR-JTS	DXGU070302MFR-JTS	<0.008**	●	●																								
			DXGU 220.5-MFL-JTS	DXGU070302MFL-JTS	<0.008**	●	●																								
Finishing to medium cutting		JTS	DXGU 220-MR-JTS	DXGU070301MR-JTS	<0.004**	●	●																								
			DXGU 220-ML-JTS	DXGU070301ML-JTS	<0.004**	●	●																								
			DXGU 220.5-MR-JTS	DXGU070302MR-JTS	<0.008**	●	●																								
			DXGU 220.5-ML-JTS	DXGU070302ML-JTS	<0.008**	●	●																								
Finishing (Low cutting force) (Sharp edge)		JSS	DXGU 220-MFR-JSS	DXGU070301MFR-JSS	<0.004**	●	●																								
			DXGU 220-MFL-JSS	DXGU070301MFL-JSS	<0.004**	●	●																								
			DXGU 220.5-MFR-JSS	DXGU070302MFR-JSS	<0.008**	●	●																								
			DXGU 220.5-MFL-JSS	DXGU070302MFL-JSS	<0.008**	●	●																								

* Corner radius has minus tolerance.

● : Line up



Int. Toolholder



- : Continuous cutting
- ◐ : Light interrupted cutting
- * : Heavy interrupted cutting

POSITIVE TYPE DOUBLE-SIDED

 **Rhombic, 55°
with hole**

	P Steel	M Stainless	K Cast iron	N Non-ferrous	S Superalloys	H Hard materials													
●	●		●																
◐	◐		◐																
●			●				●												
●			●				●												
●			●				●												
●			●				●												

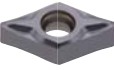
Int. Toolholder

Application	Chipbreaker	Designation		Corner radius	Coated	Coated cermet	Cermet	Uncoated													
		Inch	Metric		AH725	GT9530	NS9530	KS05F													
Finishing (Low cutting force)		JSS	DXGU 220 MR-JSS	DXGU070301MR-JSS	<0.004**	●															
			DXGU 220 ML-JSS	DXGU070301ML-JSS	<0.004**	●															
			DXGU 220.5 MR-JSS	DXGU070302MR-JSS	<0.008**	●															
			DXGU 220.5 ML-JSS	DXGU070302ML-JSS	<0.008**	●															
Finishing to medium cutting		TS	DXGU 220.5 TS	DXGU070302R-TS	0.008"	●	●	●	●												
			DXGU 220.5 TS	DXGU070302L-TS	0.008"	●	●	●	●												
			DXGU 221 TS	DXGU070304R-TS	0.016"	●	●	●	●												
			DXGU 221 TS	DXGU070304L-TS	0.016"	●	●	●	●												
			DXGU 222 TS	DXGU070308R-TS	0.031"	●	●	●	●												
			DXGU 222 TS	DXGU070308L-TS	0.031"	●	●	●	●												
Finishing (Low cutting force)		SS	DXGU 220.5 SS	DXGU070302R-SS	0.008"	●	●	●	●												
			DXGU 220.5 SS	DXGU070302L-SS	0.008"	●	●	●	●												
			DXGU 221 SS	DXGU070304R-SS	0.016"	●	●	●	●												
			DXGU 221 SS	DXGU070304L-SS	0.016"	●	●	●	●												

* Corner radius has minus tolerance.

POSITIVE TYPE DOUBLE-SIDED

 **Rhombic, 35°
with hole**

	P Steel	M Stainless	K Cast iron	N Non-ferrous	S Superalloys	H Hard materials													
●	●																		
●	●																		

Application	Chipbreaker	Designation		Corner radius	Coated																
		Inch	Metric		SH725																
Finishing (Sharp edge)		JRP	VXGU 73.50 MFRE-JRP	VXGU09T201MFRE-JRP	<0.004**	●															
			VXGU 73.50 MFLE-JRP	VXGU09T201MFLE-JRP	<0.004**	●															
			VXGU 73.50.5 MFRE-JRP	VXGU09T202MFRE-JRP	<0.008**	●															
			VXGU 73.50.5 MFLE-JRP	VXGU09T202MFLE-JRP	<0.008**	●															

* Corner radius has minus tolerance.

● : Line up

STANDARD CUTTING CONDITIONS
FOR INTERNAL TURNING

ISO	Workpiece material	Grade			Cutting speed Vc (sfm)	Depth of cut ap (in)	Feed f (ipr)
		First Choice	For surface finish	For wear resistance (High speed)			
P	Low carbon steel (1025, etc.)	AH725	-	-	164 - 591	0.012 - 0.080	0.003 - 0.012
		-	NS9530	-	262 - 820	0.012 - 0.080	0.003 - 0.012
		-	-	GT9530	262 - 984	0.012 - 0.080	0.003 - 0.012
	Carbon steel (1045, 1055, etc.)	AH725	-	-	164 - 591	0.012 - 0.080	0.003 - 0.012
		-	NS9530	-	262 - 820	0.012 - 0.080	0.003 - 0.012
		-	-	GT9530	262 - 984	0.012 - 0.080	0.003 - 0.012
	Low alloy steel (4140, etc.)	AH725	-	-	164 - 591	0.012 - 0.080	0.003 - 0.012
		-	NS9530	-	262 - 820	0.012 - 0.080	0.003 - 0.012
		-	-	GT9530	262 - 984	0.012 - 0.080	0.003 - 0.012
	Alloy steel (5120, etc.)	AH725	-	-	164 - 591	0.012 - 0.080	0.003 - 0.012
		-	NS9530	-	262 - 820	0.012 - 0.080	0.003 - 0.012
		-	-	GT9530	262 - 984	0.012 - 0.080	0.003 - 0.012
M	Stainless steel (Austenitic) (304, etc.)	AH725	-	-	164 - 492	0.012 - 0.080	0.003 - 0.012
	Stainless steel (Martensitic and ferritic) (430, etc.)	AH725	-	-	164 - 492	0.012 - 0.080	0.003 - 0.012
	Stainless steel (Precipitation hardening) (174, etc.)	AH725	-	-	164 - 492	0.012 - 0.080	0.003 - 0.012
K	Grey cast iron (No.250B, etc.)	AH725	-	-	164 - 591	0.012 - 0.080	0.003 - 0.012
		-	NS9530	-	262 - 820	0.012 - 0.080	0.003 - 0.012
		-	-	GT9530	262 - 984	0.012 - 0.080	0.003 - 0.012
	Ductile cast iron (80-55-60, etc.)	AH725	-	-	164 - 394	0.012 - 0.080	0.003 - 0.012
		-	NS9530	-	262 - 492	0.012 - 0.080	0.003 - 0.012
		-	-	GT9530	262 - 591	0.012 - 0.080	0.003 - 0.012
N	Non ferrous Metal (Aluminum alloy, etc.)	KS05F	-	-	328 - 984	0.012 - 0.080	0.003 - 0.012
	Non ferrous Metal (Cu Alloy, etc.)	KS05F	-	-	328 - 984	0.012 - 0.080	0.003 - 0.012



Int. Toolholder

ISO ETURN

A-ACLNR/L-Eco

Double-clamp boring bar, for negative 80° rhombic inserts

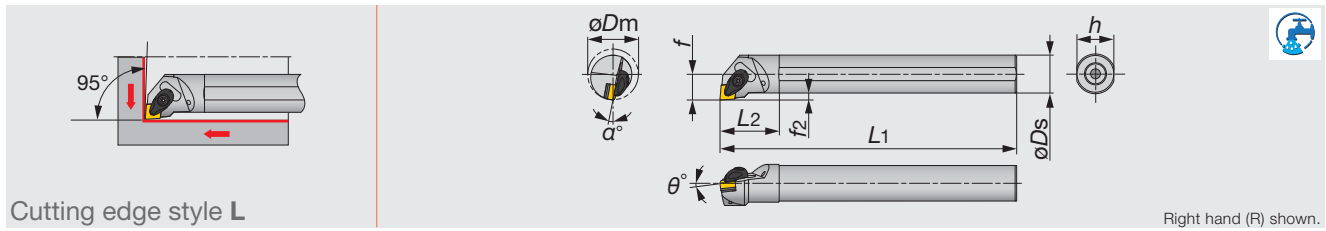

Cutting edge style L

Right hand (R) shown.

Inch	Material	ϕD_m	ϕD_s	f	L_1	L_2	h	f_2	θ°	α°	r_{ϵ}^{**}	Insert	Torque*
A16-ACLNR/L33-D20	STEEL	1.25	1.00	0.672	12	1.750	0.906	0.172	-6	-13	0.031	CN**33...	2.2
A20-ACLNR/L33-D25	STEEL	1.56	1.25	0.859	14	1.938	1.188	0.234	-6	-10	0.031	CN**33...	2.2

*Torque: Recommended torque (lbf-ft) for clamping

**re: Standard corner radius

SPARE PARTS

Designation	Clamp	Clamp screw	Spring	Spring pin	Shim	Shim screw	Wrench
A**-ACLNR/L33...	ACP3S-E	ACS-5W	BP-7	SP-2.5	ASC322	CSTB-3.5	T-15F

ISO ETURN

A-PCLNR/L-Eco

Lever clamp boring bars, for negative 80° rhombic inserts

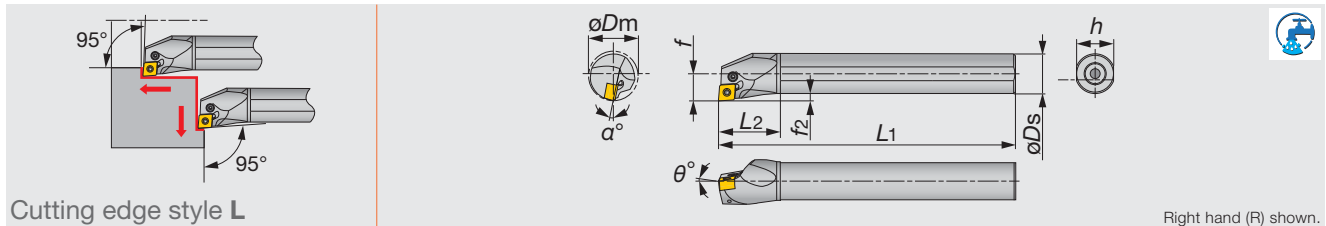

Cutting edge style L

Right hand (R) shown.

Metric	Material	ϕD_m	ϕD_s	f	L_1	L_2	h	f_2	θ°	α°	r_{ϵ}^{**}	Insert	Torque*
A16M-PCLNR/L0904-D200	STEEL	20	16	11	150	32	15	3	-6	-16	0.8	CN**0904...	1.7
A20Q-PCLNR/L0904-D250	STEEL	25	20	13	180	36	18	3	-6	-12	0.8	CN**0904...	1.7

*Torque: Recommended torque (N-m) for clamping

**re: Standard corner radius

SPARE PARTS

Designation	Clamping screw	Wrench	Lever	Oil supply attachment (Optional parts)	Screw for oil hole (Optional parts)
A16M-PCLNR/L0904-D200	LCS33	P-2F	LCL33N	-	(SSH3M3-4)
A20Q-PCLNR/L0904-D250	LCS33	P-2F	LCL33N	(EA20)	(SSH3M3-4)

Reference pages

A-ACLNR/L-Eco, A-PCLNR/L-Eco: Inserts → B052 -

ISO^ETURN

A-AWLN/L-Eco

Double-clamp boring bars, for negative trigon inserts

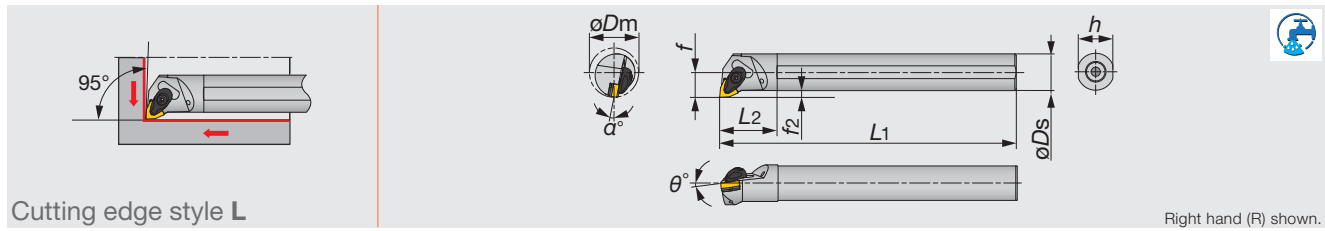

Inch	Material	ϕD_m	ϕD_s	f	L_1	L_2	h	f_2	θ°	α°	r_{ϵ}^{**}	Insert	Torque*
A16-AWLN/L33-D20	STEEL	1.25	1.00	0.672	12	1.750	0.906	0.172	-6	-13	0.031	WN**33...	2.2
A20-AWLN/L33-D25	STEEL	1.56	1.25	0.859	14	1.938	1.188	0.234	-6	-10	0.031	WN**33...	2.2

*Torque: Recommended torque (lbf-ft) for clamping

**re: Standard corner radius

SPARE PARTS

Designation	Clamp	Clamp screw	Spring	Spring pin	Shim	Shim screw	Wrench
A**-AWLN/L33...	ACP3S-E	ACS-5W	BP-7	SP-2.5	ASW322	CSTB-3.5	T-15F

ISO^ETURN

A-PWLN/L-Eco

Lever clamp boring bars, for negative trigon inserts

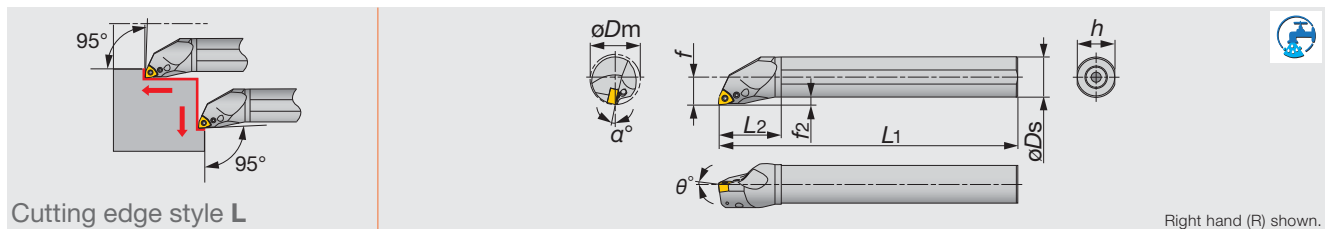

Metric	Material	ϕD_m	ϕD_s	f	L_1	L_2	h	f_2	θ°	α°	r_{ϵ}^{**}	Insert	Torque*
A16M-PWLN/L0604-D200	STEEL	20	16	11	150	32	15	3	-8	-17	0.8	WN**0604...	1.7
A20Q-PWLN/L0604-D250	STEEL	25	20	13	180	36	18	3	-6	-14	0.8	WN**0604...	1.7

*Torque: Recommended torque (N-m) for clamping

**re: Standard corner radius

SPARE PARTS

Designation	Clamping screw	Wrench	Lever	Oil supply attachment (Optional parts)	Screw for oil hole (Optional parts)
A16M-PWLN/L0604-D200	LCS33	P-2F	LCL33N	-	(SSHM3-4)
A20Q-PWLN/L0604-D250	LCS33	P-2F	LCL33N	(EA-20)	(SSHM3-4)

Reference pages

A-AWLN/L-Eco, A-PWLN/L-Eco: Inserts → B097 -

Int. Toolholder

ISO^ETURN

A-PTFNR/L-Eco

Lever clamp boring bars, for negative triangle inserts

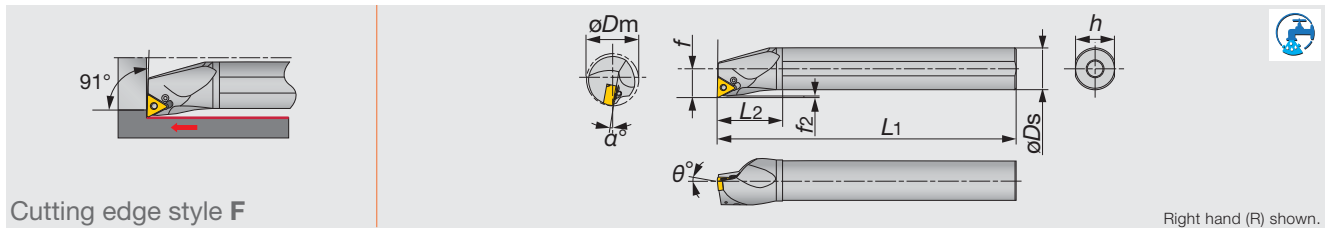

Cutting edge style F

Right hand (R) shown.

Metric	Material	ϕD_m	ϕD_s	f	L_1	L_2	h	f_2	θ°	α°	$r_{e^{**}}$	Insert	Torque*
A25R-PTFNR/L1104-D320	STEEL	32	25	17	200	45	23	1.31	-6	-12	0.8	TN**1104...	2
A32S-PTFNR/L1104-D400	STEEL	40	32	22	250	50	30	1.25	-6	-10	0.8	TN**1104...	2

*Torque: Recommended torque (N-m) for clamping

** r_e : Standard corner radius

SPARE PARTS

Designation	Clamping screw	Wrench	Lever	Oil supply attachment (Optional parts)	Screw for oil hole (Optional parts)
A25R-PTFNR/L...	LCS23A	P-2.5	LCL23	(EA-25)	(SSH4-5)
A32S-PTFNR/L...	LCS23A	P-2.5	LCL23	(EA-32)	(SSH4-5)

Int. Toolholder

ISO^ETURN

A-ADUNR/L-Eco

Double-clamp boring bars, for negative 55° rhombic inserts

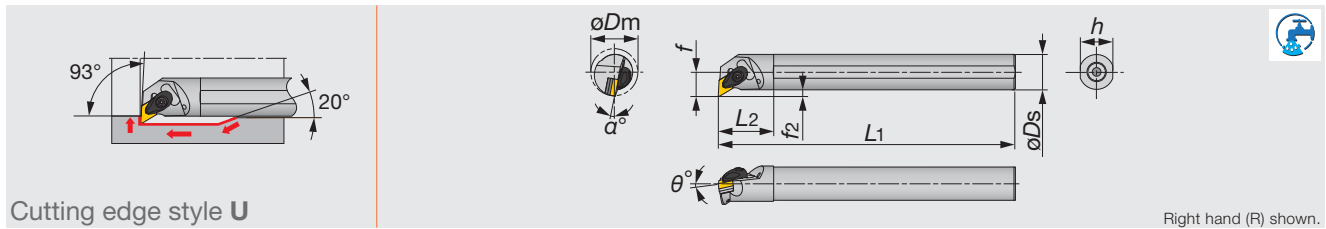

Cutting edge style U

Right hand (R) shown.

Inch	Material	ϕD_m	ϕD_s	f	L_1	L_2	h	f_2	θ°	α°	$r_{e^{**}}$	Insert	Torque*
A16-ADUNR/L33-D20	STEEL	1.25	1.00	0.672	12	1.750	0.906	0.172	-6	-13	0.031	DN**33...	2.2
A20-ADUNR/L33-D25	STEEL	1.56	1.25	0.859	14	1.938	1.188	0.234	-6	-11	0.031	DN**33...	2.2

*Torque: Recommended torque (lb-ft) for clamping

** r_e : Standard corner radius

SPARE PARTS

Designation	Clamp	Clamp screw	Spring	Spring pin	Shim	Shim screw	Wrench
A**-ADUNR/L...	ACP3S-E	ACS-5W	BP-7	SP-2.5	ASD322	CSTB-3.5	T-15F

Reference pages

A-PTFNR/L-Eco: Inserts → **B082** -

A-ADUNR/L-Eco: Inserts → **B063** -

ISO ETURN

A-PDUNR/L-Eco

Lever clamp boring bars, for negative 55° rhombic inserts

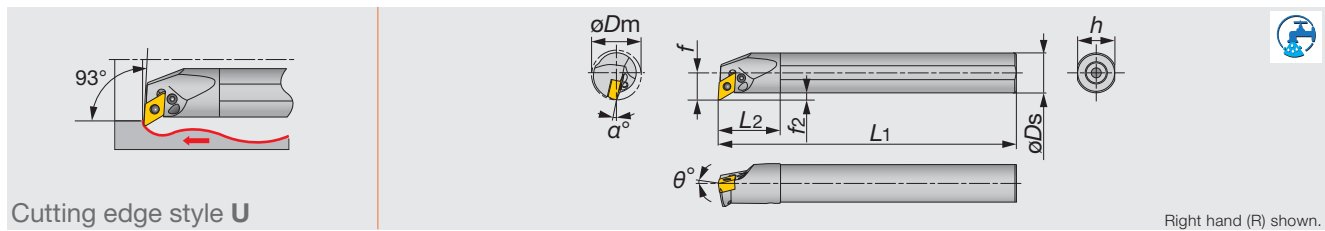

Cutting edge style U

Right hand (R) shown.

Metric	Material	ϕD_m	ϕD_s	f	L_1	L_2	h	f_2	θ°	α°	r_{ϵ}^{**}	Insert	Torque*
A20Q-PDUNR/L1104-D250	STEEL	25	20	13	180	36	18	3	-6	-14	0.8	DN**1104...	1.7

*Torque: Recommended torque (N-m) for clamping ** r_{ϵ} : Standard corner radius

When using a right or left hand insert, the right hand insert (R) is used for the left hand toolholders (PDUNL ** type), and the left hand insert (L) is used for the right hand toolholders (PDUNR ** type).

SPARE PARTS

Designation	Clamping screw	Wrench	Lever	Oil supply attachment (Optional parts)	Screw for oil hole (Optional parts)
A20Q-PDUNR/L1104-D250	LCS22A	P-2F	LCL33NL	(EA-20)	(SSHM2.5-3)

ISO ETURN

A-PTUNR/L-Eco

Lever clamp boring bars, for negative triangle inserts

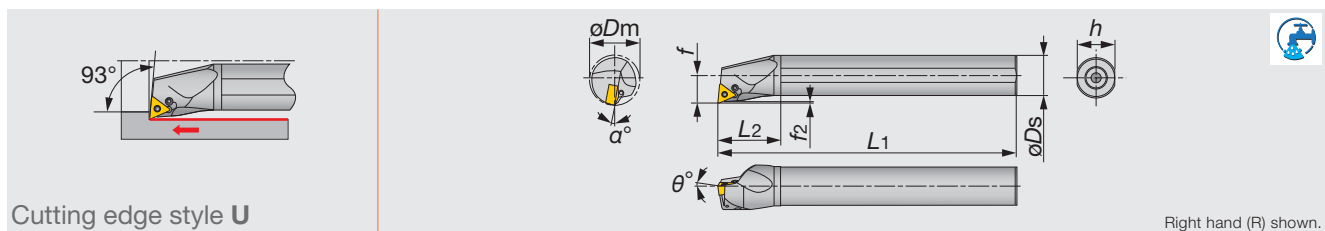

Cutting edge style U

Right hand (R) shown.

Metric	Material	ϕD_m	ϕD_s	f	L_1	L_2	h	f_2	θ°	α°	r_{ϵ}^{**}	Insert	Torque*
A25R-PTUNR/L1104-D320	STEEL	32	25	17	200	45	23	1.22	-6	-12	0.8	TN**1104...	2
A32S-PTUNR/L1104-D400	STEEL	40	32	22	250	50	30	1.16	-6	-10	0.8	TN**1104...	2

*Torque: Recommended torque (N-m) for clamping ** r_{ϵ} : Standard corner radius

SPARE PARTS

Designation	Clamping screw	Wrench	Lever	Oil supply attachment (Optional parts)	Screw for oil hole (Optional parts)
A25R-PTUNR/L1104-D320	LCS23A	P-2.5	LCL23	(EA-25)	(SSHM4-5)
A32S-PTUNR/L1104-D400	LCS23A	P-2.5	LCL23	(EA-32)	(SSHM4-5)

Reference pages

A-PDUNR/L-Eco: Inserts → **B063** -

A-PTUNR/L-Eco: Inserts → **B082** -

Lever lock type boring bars. For negative 35° rhombic insert.

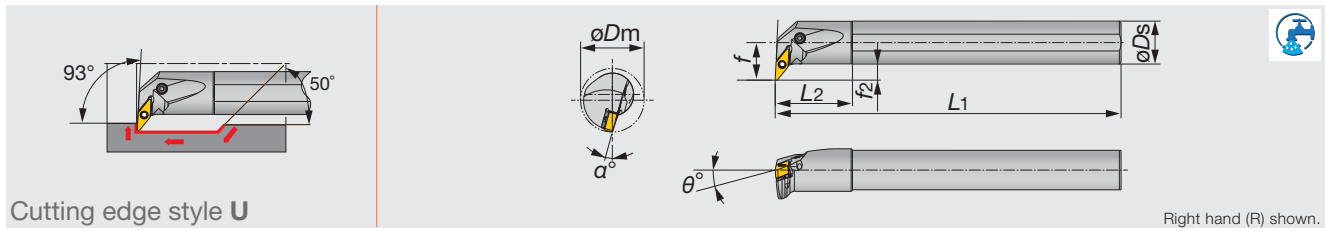

Int. Toolholder

Inch	Material	øD _m	øD _s	f	L ₁	L ₂	h	f ₂	θ°	α°	r _c **	Insert	Torque*
A16-PVUNR/L2.33-D20	STEEL	1.250	1.000	0.672	12.000	1.750	0.906	0.197	-6	-13	0.031	VN**2.33**E...	2.2
A16-PVUNR/L2.33-D24	STEEL	1.500	1.000	0.859	12.000	1.750	0.906	0.315	-6	-10	0.031	VN**2.33**E...	2.2
A20-PVUNR/L2.33-D26	STEEL	1.650	1.250	0.859	14.000	2.000	1.188	0.217	-6	-10	0.031	VN**2.33**E...	2.2

*Torque: Recommended torque (lb-ft) for clamping **r_c: Standard corner radius

Metric	Material	øD _m	øD _s	f	L ₁	L ₂	h	f ₂	θ°	α°	r _c **	Insert	Torque*
A25R-PVUNR/L1204-D320	STEEL	32	25	18	200	45	23	5.0	-5	-15	0.8	VN**1204...	3
A25R-PVUNR/L1204-D370	STEEL	37	25	22	200	45	23	8.0	-4	-15	0.8	VN**1204...	3
A32S-PVUNR/L1204-D400	STEEL	40	32	22	250	50	30	5.5	-6	-12	0.8	VN**1204...	3

*Torque: Recommended torque (N·m) for clamping **r_c: Standard corner radius

SPARE PARTS

Designation	Clamping screw	Wrench	Lever	Shim	Spring pin	Oil supply attachment	Coolant screw
A16-PVUNR/L2.33-D20							
A16-PVUNR/L2.33-D24	LCS3V	P-2.5	LCL3V	LSV212	LSP3	EA-25	SSHM4-5
A25R-PVUNR/L1204-D320							
A25R-PVUNR/L1204-D370							
A20-PVUNR/L2.33-D26	LCS3V	P-2.5	LCL3V	LSV212	LSP3	EA-32	SSHM4-5
A32S-PVUNR/L1204-D400							

Reference pages

A-PVUNR/L-Eco: Inserts → **B093** -

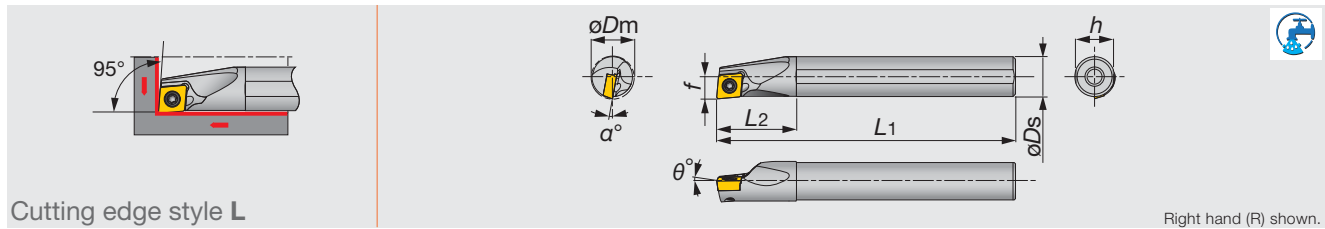

Cutting edge style L

Right hand (R) shown.

Inch	Material	ϕD_m	ϕD_s	f	L_1	L_2	h	θ°	α°	r_{ϵ}^{**}	Insert	Torque*
A06-SCLCR/L2-D08	STEEL	0.500	0.375	0.281	5.00	0.750	0.350	0	-9	0.016	CC**21.5...	0.9
A08-SCLCR/L2-D11	STEEL	0.687	0.500	0.406	5.00	1.000	0.475	0	-6	0.016	CC**21.5...	0.9
A10-SCLCR/L3-D14	STEEL	0.875	0.625	0.531	7.00	1.250	0.600	0	-7	0.016	CC**32.5...	2.2
A12-SCLCR/L3-D16	STEEL	1.000	0.750	0.594	7.00	1.438	0.725	0	-5	0.031	CC**32.5...	2.2
A16-SCLCR/L3-D20	STEEL	1.250	1.000	0.687	7.00	1.750	0.975	0	-4	0.031	CC**32.5...	2.2
E06-SCLCR/L2-D08	CARBIDE	0.500	0.375	0.281	5.00	0.750	0.350	0	-9	0.016	CC**21.5...	0.9
E08-SCLCR/L2-D11	CARBIDE	0.688	0.500	0.406	5.00	1.000	0.475	0	-6	0.016	CC**21.5...	0.9
E10-SCLCR/L2-D14	CARBIDE	0.875	0.625	0.531	7.00	1.250	0.600	0	-7	0.016	CC**21.5...	0.9
E10-SCLCR/L3-D14	CARBIDE	0.875	0.625	0.531	7.00	1.250	0.600	0	-7	0.016	CC**32.5...	2.2
E12-SCLCR/L3-D16	CARBIDE	1.000	0.750	0.594	7.00	1.438	0.725	0	-5	0.031	CC**32.5...	2.2
E16-SCLCR/L3-D20	CARBIDE	1.250	1.000	0.687	10.00	1.750	0.975	0	-4	0.031	CC**32.5...	2.2

*Torque: Recommended torque (lb-ft) for clamping ** r_{ϵ} : Standard corner radius

Note: When using a right or left hand insert, the right hand insert (R) is used for the left hand toolholders (SCLCL** type), and the left hand insert (L) is used for the right hand toolholders (SCLCR** type).

SPARE PARTS



Designation	Clamping screw	Wrench
A**-SCLCR/L2-D...	CSTB-2.5S	T-8F
A**-SCLCR/L3-D...	CSTB-4S	T-15F
E06-SCLCR/L2-D08	CSTB-2.5S	T-8F
E**-SCLCR/L2-D...	CSTB-2.5B	T-8F
E**-SCLCR/L3-D...	CSTB-4S	T-15F

Reference pages

A/E-SCLCR/L: Inserts → B106 -, CBN → B170 -, PCD → B179

Metric	Material	øDm	øDs	f	L1	L2	h	θ°	α°	re**	Insert	Torque*
A04F-SCLCR/L03-D050	STEEL	5	4	2.5	80	8	3.8	0	-15	0.2	CC**03X1...	0.6
A05F-SCLCR/L03-D060	STEEL	6	5	3	80	9	4.8	0	-13	0.2	CC**03X1...	0.6
A06G-SCLCR/L04-D070	STEEL	7	6	3.5	90	11	5.75	0	-13	0.2	CC**04T1...	0.6
A07G-SCLCR/L04-D080	STEEL	8	7	4	90	12	6.75	0	-11	0.2	CC**04T1...	0.6
A08H-SCLCR/L06-D100	STEEL	10	8	5.5	100	16	7.5	0	-13	0.4	CC**0602...	1.2
A10F-SCLCR06-D120	STEEL	12	10	6	80	20	9	0	-10	0.4	CC**0602...	1.2
A10K-SCLCR/L06-D120	STEEL	12	10	6	125	20	9	0	-10	0.4	CC**0602...	1.2
A12H-SCLCR06-D140	STEEL	14	12	7	100	24	11	0	-8	0.4	CC**0602...	1.2
A12M-SCLCR/L06-D140	STEEL	14	12	7	150	24	11	0	-8	0.4	CC**0602...	1.2
A12H-SCLCR06-D160	STEEL	16	12	9	100	24	11	0	-7	0.4	CC**0602...	1.2
A12M-SCLCR/L06-D160	STEEL	16	12	9	150	24	11	0	-7	0.4	CC**0602...	1.2
A16K-SCLCR09-D180	STEEL	18	16	9	125	32	15	0	-9	0.8	CC**09T3...	3
A16Q-SCLCR/L09-D180	STEEL	18	16	9	180	32	15	0	-10	0.8	CC**09T3...	3
A16K-SCLCR09-D200	STEEL	20	16	11	125	32	15	0	-9	0.8	CC**09T3...	3
A16Q-SCLCR/L09-D200	STEEL	20	16	11	180	32	15	0	-9	0.8	CC**09T3...	3
A20R-SCLCR/L09-D220	STEEL	22	20	11	200	32	18	0	-8	0.8	CC**09T3...	3
A25S-SCLCR/L09-D270	STEEL	27	25	13.5	250	45	23	0	-6	0.8	CC**09T3...	3
E04G-SCLCR/L03-D050	CARBIDE	5	4	2.5	90	9	3.8	0	-15	0.2	CC**03X1...	0.6
E05G-SCLCR/L03-D060	CARBIDE	6	5	3	90	10	4.8	0	-13	0.2	CC**03X1...	0.6
E06H-SCLCR/L04-D070	CARBIDE	7	6	3.5	100	12	5.75	0	-13	0.2	CC**04T1...	0.6
E07H-SCLCR/L04-D080	CARBIDE	8	7	4	100	14	6.75	0	-11	0.2	CC**04T1...	0.6
E08G-SCLCR06-D100	CARBIDE	10	8	5.5	90	22	7.5	0	-13	0.4	CC**0602...	1.2
E08K-SCLCR/L06-D100	CARBIDE	10	8	5.5	125	22	7.5	0	-13	0.4	CC**0602...	1.2
E10F-SCLCR06-D120	CARBIDE	12	10	6	80	25	9	0	-10	0.4	CC**0602...	1.2
E10H-SCLCR06-D120	CARBIDE	12	10	6	100	25	9	0	-10	0.4	CC**0602...	1.2
E10M-SCLCR/L06-D120	CARBIDE	12	10	6	150	25	9	0	-10	0.4	CC**0602...	1.2
E12G-SCLCR06-D140	CARBIDE	14	12	7	90	27	11	0	-8	0.4	CC**0602...	1.2
E12J-SCLCR06-D140	CARBIDE	14	12	7	110	27	11	0	-8	0.4	CC**0602...	1.2
E12Q-SCLCR/L06-D140	CARBIDE	14	12	7	180	27	11	0	-8	0.4	CC**0602...	1.2
E12G-SCLCR06-D160	CARBIDE	16	12	9	90	27	11	0	-7	0.4	CC**0602...	1.2
E12J-SCLCR06-D160	CARBIDE	16	12	9	110	27	11	0	-7	0.4	CC**0602...	1.2
E12Q-SCLCR/L06-D160	CARBIDE	16	12	9	180	27	11	0	-7	0.4	CC**0602...	1.2
E16H-SCLCR09-D180	CARBIDE	18	16	9	100	32	15	0	-10	0.8	CC**09T3...	3
E16L-SCLCR09-D180	CARBIDE	18	16	9	130	32	15	0	-10	0.8	CC**09T3...	3
E16R-SCLCR/L09-D180	CARBIDE	18	16	9	200	32	15	0	-10	0.8	CC**09T3...	3
E16H-SCLCR09-D200	CARBIDE	20	16	11	100	32	15	0	-9	0.8	CC**09T3...	3
E16L-SCLCR09-D200	CARBIDE	20	16	11	130	32	15	0	-9	0.8	CC**09T3...	3
E16R-SCLCR/L09-D200	CARBIDE	20	16	11	200	32	15	0	-9	0.8	CC**09T3...	3
E20S-SCLCR09-D220	CARBIDE	22	20	11	250	36	18	0	-8	0.8	CC**09T3...	3
E25T-SCLCR09-D270	CARBIDE	27	25	13.5	300	45	23	0	-6	0.8	CC**09T3...	3

*Torque: Recommended torque (N-m) for clamping **r_c: Standard corner radius

Note: When using a right or left hand insert, the right hand insert (R) is used for the left hand toolholders (SCLCL** type), and the left hand insert (L) is used for the right hand toolholders (SCLCR** type).

SPARE PARTS



Designation	Clamping screw	Wrench
A**-SCLCR/L03-D...	CSTA-1.6	T-6F
A**-SCLCR/L04-D...	CSTB-2	T-6F
A**-SCLCR/L06-D...	CSTB-2.5S	T-8F
A**-SCLCR/L09-D...	CSTB-4S	T-15F
E**-SCLCR/L03-D...	CSTA-1.6	T-6F
E**-SCLCR/L04-D...	CSTB-2	T-6F
E**-SCLCR/L06-D...	CSTB-2.5S	T-8F
E16*-SCLCR/L09-D...	CSTB-4L060	T-15F
E2**-SCLCR/L09-D...	CSTB-4S	T-15F

Reference pages

A/E-SCLCR/L: Inserts → B106 -, CBN → B170 -, PCD → B179

S/A/C/E-SCLCR/L

Screw-on boring bars, for positive 80° rhombic inserts

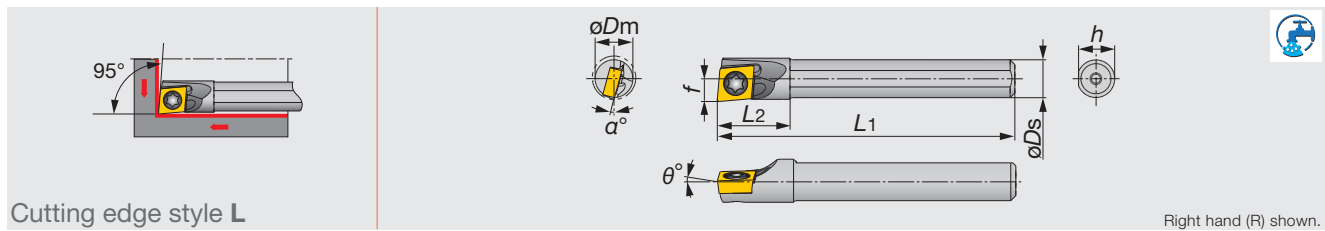

Cutting edge style L

Right hand (R) shown.

Inch	Material	$\varnothing D_m$	$\varnothing D_s$	f	L_1	L_2	h	θ°	α°	Insert
S06-SCLCR/L2	STEEL	0.500	0.375	0.250	5.00	0.980	0.335	0	12	CC**21.5...
S08-SCLCR/L2	STEEL	0.625	0.500	0.313	6.00	0.980	0.461	0	10	CC**21.5...
S10-SCLCR/L3	STEEL	0.813	0.625	0.406	7.00	1.180	0.547	0	10	CC**32.5...
S12-SCLCR/L3	STEEL	1.000	0.750	0.500	8.00	1.380	0.670	0	8	CC**32.5...
A05-SCLCR/L2	STEEL WITH HOLE	0.375	0.312	0.219	4.50	-	0.280	0	15	CC**21.5...
A06-SCLCR/L2	STEEL WITH HOLE	0.437	0.375	0.250	4.75	-	0.350	0	15	CC**21.5...
A08-SCLCR/L2	STEEL WITH HOLE	0.562	0.500	0.313	5.00	-	0.475	0	15	CC**21.5...
A08-SCLCR/L3	STEEL WITH HOLE	0.562	0.500	0.313	5.00	-	0.475	0	15	CC**32.5...
A10-SCLCR/L2	STEEL WITH HOLE	0.718	0.625	0.406	7.00	-	0.600	0	12	CC**21.5...
A10-SCLCR/L3	STEEL WITH HOLE	0.718	0.625	0.406	7.00	-	0.600	0	12	CC**32.5...
A12-SCLCR/L3	STEEL WITH HOLE	0.875	0.750	0.500	7.00	-	0.725	0	8	CC**32.5...
A16-SCLCR/L3	STEEL WITH HOLE	1.280	1.000	0.640	7.00	-	0.975	0	4	CC**32.5...
C06-SCLCR/L2	CARBIDE	0.470	0.375	0.245	5.00	-	0.350	0	15	CC**21.5...
C08-SCLCR/L2	CARBIDE	0.592	0.500	0.308	5.00	-	0.475	0	15	CC**21.5...
C10-SCLCR/L2	CARBIDE	0.760	0.625	0.401	7.00	-	0.600	0	12	CC**21.5...
C10-SCLCR/L3	CARBIDE	0.760	0.625	0.401	7.00	-	0.600	0	12	CC**32.5...
C12-SCLCR/L3	CARBIDE	0.920	0.750	0.495	7.00	-	0.725	0	8	CC**32.5...
C16-SCLCR/L3	CARBIDE	1.280	1.000	0.640	7.00	-	-	0	-	CC**32.5...
E06-SCLCR/L2	CARBIDE W/HOLE	0.470	0.375	0.245	5.00	-	0.350	0	15	CC**21.5...
E08-SCLCR/L2	CARBIDE W/HOLE	0.592	0.500	0.308	5.00	-	0.475	0	15	CC**21.5...
E10-SCLCR/L2	CARBIDE W/HOLE	0.760	0.625	0.401	7.00	-	0.600	0	12	CC**21.5...
E10-SCLCR/L3	CARBIDE W/HOLE	0.760	0.625	0.401	7.00	-	0.600	0	12	CC**32.5...
E12-SCLCR/L3	CARBIDE W/HOLE	0.920	0.750	0.495	7.00	-	0.725	0	8	CC**32.5...
E16-SCLCR/L3	CARBIDE W/HOLE	1.250	1.000	0.687	7.00	-	0.975	0	4	CC**32.5...

SPARE PARTS



Designation	Clamping screw	Wrench
S**-SCLCR/L2	CSTB-2.5	T-8F
S**-SCLCR/L3	CSTB-4S	T-15F
A0*-SCLCR/L2	CSTB-2.5	T-8F
A08-SCLCR/L3	CSTB-4S	T-15F
A10-SCLCR/L2	CSTB-2.5	T-8F
A1*-SCLCR/L3	CSTB-4S	T-15F
C**-SCLCR/L2	CSTB-2.5	T-8F
C**-SCLCR/L3	CSTB-4S	T-15F
E**-SCLCR/L2	CSTB-2.5	T-8F
E**-SCLCR/L3	CSTB-4S	T-15F

Reference pages

S/A/C/E-SCLCR/L: Inserts → B106 -, CBN → B170 -, PCD → B179

Int. Toolholder

STREAMJETBAR

A/E-SEXPR/L

Screw-on boring bars, for positive 75° rhombic inserts

Int. Toolholder

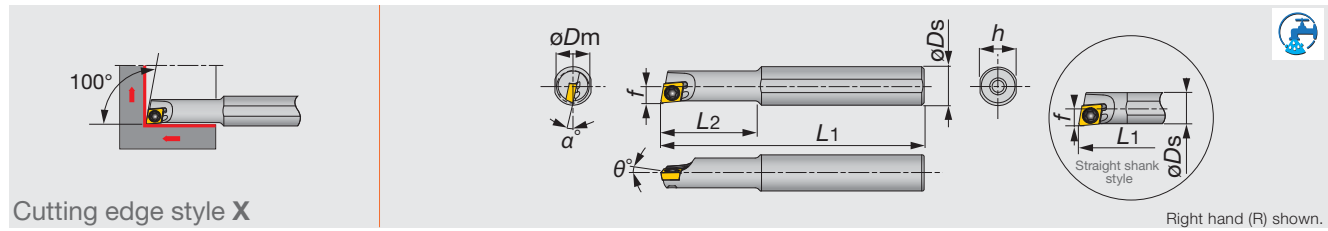

Cutting edge style X

Right hand (R) shown.

Inch	Material	øD _m	øD _s	f	L ₁	L ₂	h	θ°	α°	r _e **	Insert	Torque*
A05-SEXPR/L04-D04	STEEL	0.250	0.313	0.125	5.000	0.812	0.287	0	-12	0.016	EPGT52...	0.44
E05-SEXPR04-D04	CARBIDE	0.250	0.313	0.125	5.000	1.562	0.287	0	-12	0.016	EPGT52...	0.44
Metric	Material	øD _m	øD _s	f	L ₁	L ₂	h	θ°	α°	r _e **	Insert	Torque*
A04F-SEXPR/L03-D045	STEEL	4.5	4	2.3	80	8	3.8	0	-15	0.2	EP**03X1...	0.6
A04F-SEXPR/L03-D050	STEEL	5	4	2.5	80	8	3.8	0	-13	0.2	EP**03X1...	0.6
A05F-SEXPR/L04-D055	STEEL	5.5	5	2.75	80	9	4.8	0	-12	0.4	EP**0401...	0.6
A06G-SEXPR/L04-D070	STEEL	7	6	3.6	90	11	5.75	0	-12	0.4	EP**0401...	0.6
A08H-SEXPR/L04-D055	STEEL	5.5	8	2.75	100	16	7.5	0	-12	0.4	EP**0401...	0.6
A08H-SEXPR/L04-D070	STEEL	7	8	3.6	100	20	7.5	0	-12	0.4	EP**0401...	0.6
E04G-SEXPR/L03-D045	CARBIDE	4.5	4	2.3	90	9	3.8	0	-15	0.2	EP**03X1...	0.6
E04G-SEXPR/L03-D050	CARBIDE	5	4	2.5	90	9	3.8	0	-13	0.2	EP**03X1...	0.6
E05G-SEXPR/L04-D055	CARBIDE	5.5	5	2.75	90	10	4.8	0	-12	0.4	EP**0401...	0.6
E06H-SEXPR/L04-D070	CARBIDE	7	6	3.6	100	12	5.75	0	-12	0.4	EP**0401...	0.6
E08K-SEXPR/L04-D055	CARBIDE	5.5	8	2.75	125	28	7.5	0	-12	0.4	EP**0401...	0.6
E08K-SEXPR/L04-D070	CARBIDE	7	8	3.6	125	40	7.5	0	-12	0.4	EP**0401...	0.6

*Torque: Recommended torque (lbf-ft, N-m) for clamping **r_e: Standard corner radius

Note: When using a right or left hand insert, the right hand insert (R) is used for the left hand toolholders (SEXPL** type), and the left hand insert (L) is used for the right hand toolholders (SEXPR** type).

SPARE PARTS



Designation	Clamping screw	Wrench
A**-SEXPR/L03-D...	CSTA-1.6	T-6F
A**-SEXPR/L04-D...	CSTB-2	T-6F
E**-SEXPR/L03-D...	CSTA-1.6	T-6F
E**-SEXPR/L04-D...	CSTB-2	T-6F

Reference pages

A/E-SEXPR/L: Inserts → B124 -, CBN → B173, PCD → B180

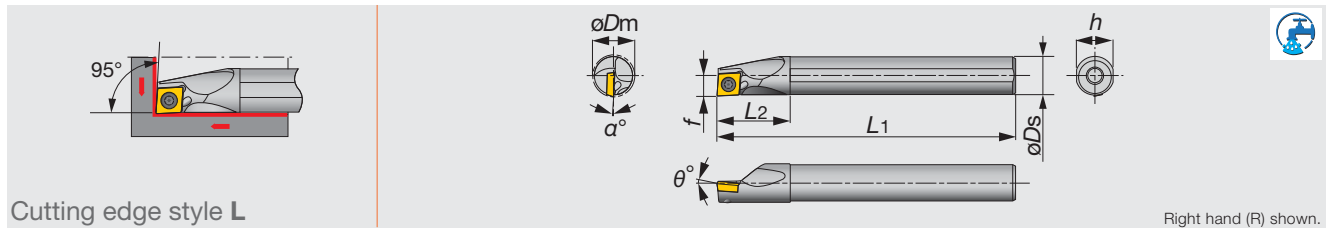

Cutting edge style L

Right hand (R) shown.

Inch	Material	ϕD_m	ϕD_s	f	L_1	L_2	h	θ°	α°	r_{ϵ}^{**}	Insert	Torque*
A06-SCLPR/L2-D08	STEEL	0.500	0.375	0.281	5.00	0.750	0.350	5	-5	0.016	CP**21.5...	0.9
A08-SCLPR/L2-D11	STEEL	0.687	0.500	0.406	5.00	1.000	0.475	5	-2	0.016	CP**21.5...	0.9
A10-SCLPR/L3-D14	STEEL	0.875	0.625	0.531	7.00	1.250	0.600	5	-2	0.016	CP**32.5...	2.2
E06-SCLPR/L2-D08	CARBIDE	0.500	0.375	0.281	5.00	0.750	0.350	0	-9	0.016	CP**21.5...	0.9
E08-SCLPR/L2-D11	CARBIDE	0.688	0.500	0.406	5.00	1.000	0.475	0	-6	0.016	CP**21.5...	0.9
E10-SCLPR/L3-D14	CARBIDE	0.875	0.625	0.531	7.00	1.250	0.600	0	-7	0.032	CP**32.5...	2.2

*Torque: Recommended torque (lb-ft) for clamping ** r_{ϵ} : Standard corner radius

Note: When using a right or left hand insert, the right hand insert (R) is used for the left hand toolholders (SCLPL** type), and the left hand insert (L) is used for the right hand toolholders (SCLPR** type).

SPARE PARTS



Designation	Clamping screw	Wrench
A06-SCLPR/L2-D08	CSTB-2.5L042	T-8F
A08-SCLPR/L2-D11	CSTB-2.5S	T-8F
A10-SCLPR/L3-D14	CSTB-4L070	T-15F
E06-SCLPR/L2-D08	CSTB-2.5S	T-8F
E08-SCLPR/L2-D11	CSTB-2.5B	T-8F
E10-SCLPR/L3-D14	CSTB-4S	T-15F

Int. Toolholder

Int. Toolholder

Metric	Material	øDm	øDs	f	L1	L2	h	θ°	α°	re**	Insert	Torque*
A08H-SCLPR/L06-D100	STEEL	10	8	5.5	100	16	7.5	5	-8	0.4	CP**0602...	1.2
A10K-SCLPR/L06-D120	STEEL	12	10	6	125	20	9	5	-5	0.4	CP**0602...	1.2
A10K-SCLPR/L08-D120	STEEL	12	10	6	125	20	9	5	-5	0.4	CP**0802...	1.4
A12M-SCLPR/L06-D140	STEEL	14	12	7	150	24	11	5	-4	0.4	CP**0602...	1.2
A12M-SCLPR/L08-D140	STEEL	14	12	7	150	24	11	5	-4	0.4	CP**0802...	1.4
A12M-SCLPR/L08-D160	STEEL	16	12	9	150	24	11	5	-3	0.4	CP**0802...	1.4
A16Q-SCLPR/L09-D180	STEEL	18	16	9	180	32	15	5	-3.5	0.8	CP**0903...	3
A16Q-SCLPR/L09-D200	STEEL	20	16	11	180	32	15	5	-3	0.8	CP**0903...	3
A20R-SCLPR/L09-D220	STEEL	22	20	11	200	36	18	5	-2	0.8	CP**0903...	3
A25S-SCLPR/L09-D270	STEEL	27	25	13.5	250	45	23	5	-1	0.8	CP**0903...	3
E08K-SCLPR/L06-D100	CARBIDE	10	8	5.5	125	22	7.5	5	-8	0.4	CP**0602...	1.2
E10M-SCLPR/L06-D120	CARBIDE	12	10	6	150	25	9	5	-5	0.4	CP**0602...	1.2
E10H-SCLPR08-D120	CARBIDE	12	10	6	100	25	9	5	-5	0.4	CP**0802...	1.4
E10M-SCLPR/L08-D120	CARBIDE	12	10	6	150	25	9	5	-5	0.4	CP**0802...	1.4
E12Q-SCLPR/L06-D140	CARBIDE	14	12	7	180	27	11	5	-4	0.4	CP**0602...	1.2
E12G-SCLPR08-D140	CARBIDE	14	12	7	90	27	11	5	-4	0.4	CP**0802...	1.4
E12J-SCLPR08-D140	CARBIDE	14	12	7	110	27	11	5	-4	0.4	CP**0802...	1.4
E12Q-SCLPR/L08-D140	CARBIDE	14	12	7	180	27	11	5	-4	0.4	CP**0802...	1.4
E12G-SCLPR08-D160	CARBIDE	16	12	9	90	27	11	5	-3	0.4	CP**0802...	1.4
E12J-SCLPR08-D160	CARBIDE	16	12	9	110	27	11	5	-3	0.4	CP**0802...	1.4
E12Q-SCLPR/L08-D160	CARBIDE	16	12	9	180	27	11	5	-3	0.4	CP**0802...	1.4
E16H-SCLPR09-D180	CARBIDE	18	16	9	100	32	15	5	-3.5	0.8	CP**0903...	3
E16L-SCLPR09-D180	CARBIDE	18	16	9	130	32	15	5	-3.5	0.8	CP**0903...	3
E16R-SCLPL09-D180	CARBIDE	18	16	9	200	32	15	5	-3.5	0.8	CP**0903...	3
E16H-SCLPR09-D200	CARBIDE	20	16	11	100	32	15	5	-3	0.8	CP**0903...	3
E16L-SCLPR09-D200	CARBIDE	20	16	11	130	32	15	5	-3	0.8	CP**0903...	3
E16R-SCLPL09-D200	CARBIDE	20	16	11	200	32	15	5	-3	0.8	CP**0903...	3

*Torque: Recommended torque (N-m) for clamping **re: Standard corner radius

Note: When using a right or left hand insert, the right hand insert (R) is used for the left hand toolholders (SCLPL** type), and the left hand insert (L) is used for the right hand toolholders (SCLPR** type).

SPARE PARTS



Designation	Clamping screw	Wrench
A**-SCLPR/L06-D...	CSTB-2.5S	T-8F
A10K-SCLPR/L08-D120	CSTB-3L042	T-9F
A12M-SCLPR/L08-D...	CSTB-3L050	T-9F
A**-SCLPR/L09-D...	CSTB-4L060	T-15F
E**-SCLPR/L06-D...	CSTB-2.5S	T-8F
E10*-SCLPR/L08-D...	CSTB-3L042	T-9F
E12*-SCLPR/L08-D...	CSTB-3L050	T-9F
E16*-SCLPR/L09-D...	CSTB-4L060	T-15F

Reference pages

A/E-SCLPR/L: Inserts → **B113** -

J-SERIES

JS-SEXPR/L

Screw-on boring bar, for positive 75° rhombic inserts

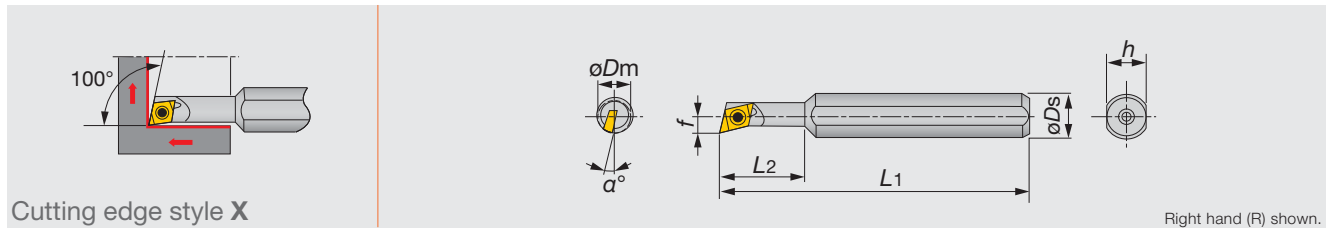

Cutting edge style X

Right hand (R) shown.

Metric	Material	ϕD_m	ϕD_s	f	L_1	L_2	h	α°	r_ϵ^{**}	Insert	Torque*
JS08H-SEXPR045	STEEL	5.5	8	2.7	100	16	7	12	0.4	EP**0401...	0.6
JS08H-SEXPR047	STEEL	7	8	3.6	100	20	7	12	0.4	EP**0401...	0.6

*Torque: Recommended torque (N-m) for clamping ** r_ϵ : Standard corner radius

Note: When using a right or left hand insert, the right hand insert (R) is used for the left hand toolholders (SEXPL** type), and the left hand insert (L) is used for the right hand toolholders (SEXPR** type).

SPARE PARTS



Designation	Clamping screw	Wrench
JS08H-SEXPR04...	CSTB-2	T-6F



Int. Toolholder

Reference pages

JS-SEXPR/L: Inserts → B124, CBN → B173, PCD → B180

STREAMJETBAR

A-SVJBR/L

Screw-on boring bars, for positive 35° rhombic inserts

Int. Toolholder

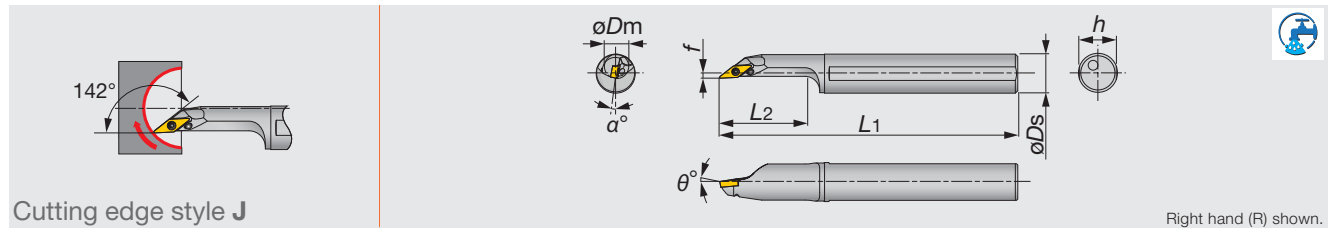

Cutting edge style J

Right hand (R) shown.

Inch	Material	ϕD_m	ϕD_s	f	L_1	L_2	h	θ°	α°	r_{ϵ}^{**}	Insert	Torque*
A10-SVJBR2-D16	STEEL	1.000	0.625	0.156	7.000	1.250	0.600	-5	-6	0.016	VB**22...	0.89
Metric	Material	ϕD_m	ϕD_s	f	L_1	L_2	h	θ°	α°	r_{ϵ}^{**}	Insert	Torque*
A20R-SVJBR/L11-D250	STEEL	25	20	2	200	40	18	-5	-5	0.4	VB**1103...	1.2
A25S-SVJBR/L11-D300	STEEL	30	25	3.5	250	50	23	-5	-5	0.4	VB**1103...	1.2

*Torque: Recommended torque (lbf-ft, N-m) for clamping ** r_{ϵ} : Standard corner radius

Note: When using a right or left hand insert, the right hand insert (R) is used for the left hand toolholders (SVJBL** type), and the left hand insert (L) is used for the right hand toolholders (SVJBR** type).

SPARE PARTS

Designation	Clamping screw	Wrench
A**-SVJB**-D...	CSTB-2.5	T-8F

STREAMJETBAR

A-SVJCR/L

Screw-on boring bars, for positive 35° rhombic inserts

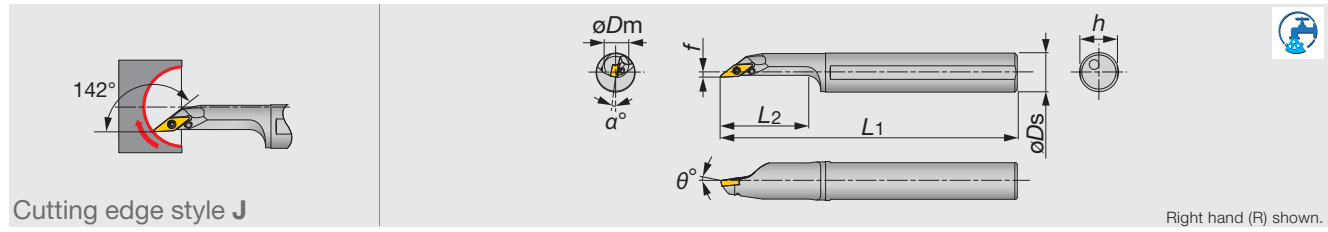

Cutting edge style J

Right hand (R) shown.

Inch	Material	ϕD_m	ϕD_s	f	L_1	L_2	h	θ°	α°	r_{ϵ}^{**}	Insert	Torque*
A10-SVJCR2-D16	STEEL	1.000	0.625	0.156	7.000	1.750	0.600	-5	-6	0.016	VC**22..	0.89
Metric	Material	ϕD_m	ϕD_s	f	L_1	L_2	h	θ°	α°	r_{ϵ}^{**}	Insert	Torque*
A12M-SVJCR/L08-D160	STEEL	16	12	2	150	28	11	-5	-5	0.4	VC**0802...	0.6
A16Q-SVJCR/L08-D200	STEEL	20	16	2	180	35	15	-5	-5	0.4	VC**0802...	0.6

*Torque: Recommended torque (lbf-ft, N-m) for clamping ** r_{ϵ} : Standard corner radius

Note: When using a right or left hand insert, the right hand insert (R) is used for the left hand toolholders (SVJCL** type), and the left hand insert (L) is used for the right hand toolholders (SVJCR** type).

SPARE PARTS

Designation	Clamping screw	Wrench
A10-SVJCR2-D16	CSTB-2.5	T-8F
A**-SVJC*08-D...	CSTB-2L	T-6F

Reference pages

A-SVJBR/L: Inserts → B147 -, CBN → B171 -

A-SVJCR/L: Inserts → B149 -

A-SSKPR

Screw-on boring bars, for positive square inserts

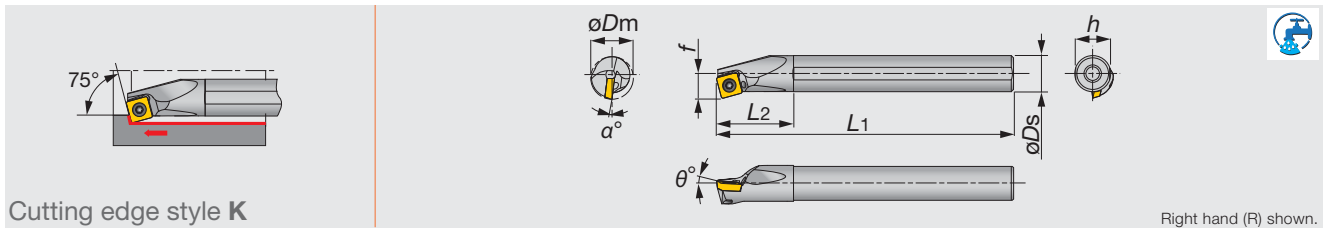

Cutting edge style K

Right hand (R) shown.

Metric	Material	ϕD_m	ϕD_s	f	L_1	L_2	h	θ°	α°	r_ϵ^{**}	Insert	Torque*
A16Q-SSKPR09-D200	STEEL	20	16	11	180	32	15	5	-6	0.8	SP**0903...	3
A20R-SSKPR09-D240	STEEL	24	20	13	200	36	18	5	-2	0.8	SP**0903...	3
A25S-SSKPR12-D310	STEEL	31	25	17	250	45	23	5	-2	0.8	SP**1204...	6

*Torque: Recommended torque (N-m) for clamping ** r_ϵ : Standard corner radius

Note: When using a right or left hand insert, the right hand insert (R) is used for the left hand toolholders (SSKPL** type), and the left hand insert (L) is used for the right hand toolholders (SSKPR** type).

SPARE PARTS



Designation	Clamping screw	Wrench
A**-SSKPR09-D2*0	CSTB-4L060	T-15F
A25S-SSKPR12-D310	CSTB-5S	T-20F

Int. Toolholder

Reference pages

A-SSKPR: Inserts → B130 -, CBN → B170

STREAMJETBAR

A/E-STFCR/L

Screw-on boring bars, for positive triangle inserts

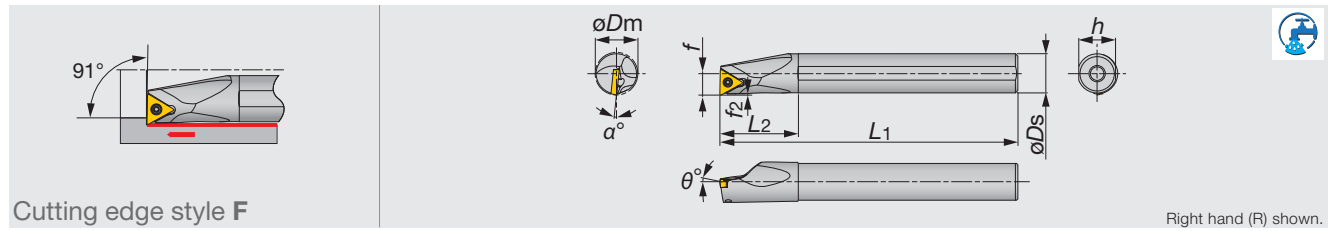

Cutting edge style F

Right hand (R) shown.

Inch	Material	ϕD_m	ϕD_s	f	L_1	L_2	h	f_2	θ°	α°	$r_{e^{**}}$	Insert	Torque*
E06-STFCR/L2-D08	CARBIDE	0.500	0.375	0.281	5.000	1.000	0.350	-	0	-9	0.016	TC**21.5...	0.89
E08-STFCR2-D11	CARBIDE	0.688	0.500	0.406	5.000	1.062	0.475	-	0	-6	0.016	TC**21.5...	0.89
E10-STFCR2-D14	CARBIDE	0.875	0.625	0.531	7.000	1.250	0.600	-	0	-5	0.016	TC**21.5...	0.89
E12-STFCR3-D16	CARBIDE	1.000	0.750	0.594	7.000	1.438	0.750	-	0	-5	0.032	TC**32.5...	2.2

Metric	Material	ϕD_m	ϕD_s	f	L_1	L_2	h	f_2	θ°	α°	$r_{e^{**}}$	Insert	Torque*
A10K-STFCR/L1103-D120	STEEL	12	10	6.5	125	20	9	0.6	0	-13	0.4	TC**1103...	1.2
A12M-STFCR/L1103-D140	STEEL	14	12	7	150	24	11	0.5	0	-10	0.4	TC**1103...	1.2
A16Q-STFCR/L1103-D180	STEEL	18	16	9	180	32	15	0.5	0	-7	0.4	TC**1103...	1.2
E10M-STFCR/L1103-D120	CARBIDE	12	10	6.5	150	25	9	0.7	0	-13	0.4	TC**1103...	1.2
E12Q-STFCR/L1103-D140	CARBIDE	14	12	7	180	27	11	0.5	0	-10	0.4	TC**1103...	1.2
E16R-STFCR/L1103-D180	CARBIDE	18	16	9	200	32	15	0.5	0	-7	0.4	TC**1103...	1.2

*Torque: Recommended torque (lbf-ft, N-m) for clamping **re: Standard corner radius

Note: When using a right or left hand insert, the right hand insert (R) is used for the left hand toolholders (STFCL** type), and the left hand insert (L) is used for the right hand toolholders (STFCR** type).

SPARE PARTS

Designation	Clamping screw	Wrench
E**-STFCR/L2-D...	CSTB-2.5	T-8F
E12-STFCR3-D16	CSTB-4S	T15-F
A**-STFCR/L1103-D...	CSTB-2.5	T-8F
E**-STFCR/L1103-D...	CSTB-2.5	T-8F

A-STFCR/L

Screw-on boring bars, for positive triangle inserts

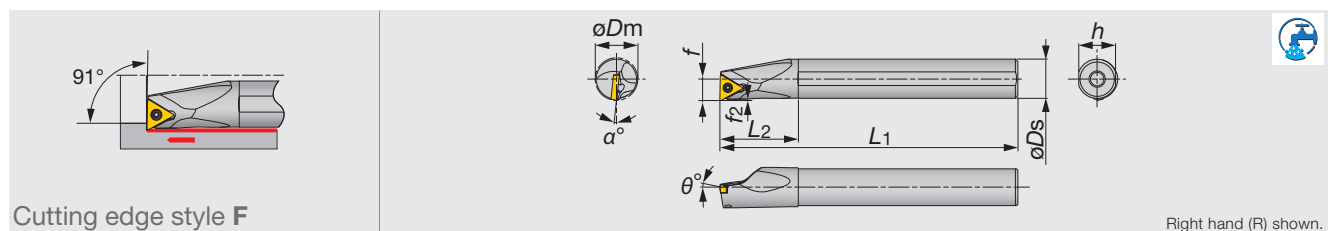

Cutting edge style F

Right hand (R) shown.

Inch	Material	ϕD_m	ϕD_s	f	L_1	L_2	h	f_2	θ°	α°	$r_{e^{**}}$	Insert	Torque*
A06-STFCR/L2	STEEL	0.430	0.375	0.256	6.000	0.625	0.340	-	0	11	0.016	TC**21.5...	0.89
A08-STFCR/L2	STEEL	0.600	0.500	0.312	8.000	0.748	0.460	-	0	9	0.016	TC**21.5...	0.89
A10-STFCR/L2	STEEL	0.770	0.625	0.400	10.000	1.250	0.575	-	0	7	0.016	TC**21.5...	0.89
A12-STFCR/L3	STEEL	0.930	0.750	0.500	10.000	1.870	0.700	-	0	6	0.032	TC**32.5...	2.2

*Torque: Recommended torque (lbf-ft) for clamping **re: Standard corner radius

Note: When using a right or left hand insert, the right hand insert (R) is used for the left hand toolholders (STFCL** type), and the left hand insert (L) is used for the right hand toolholders (STFCR** type).

SPARE PARTS

Designation	Clamping screw	Wrench
A**-STFCR/L2	CSTB-2.5	T-8F
A12-STFCR/L3	CSTB-4S	T15-F

Reference pages

A/E-STFCR/L: Inserts → B133 -, PCD → B179

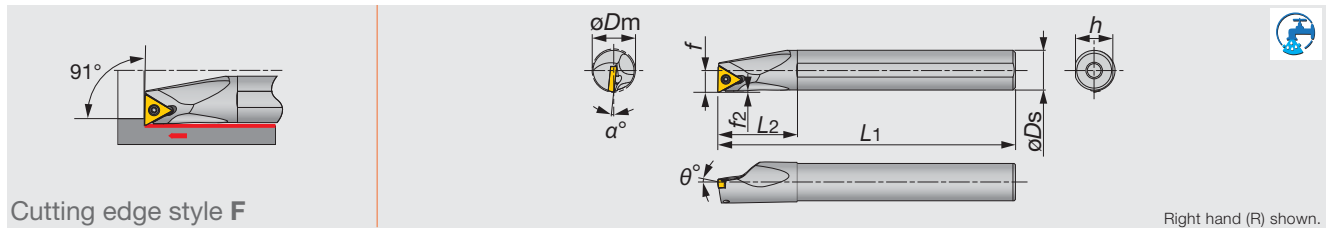

Cutting edge style F

Right hand (R) shown.

Inch	Material	ϕD_m	ϕD_s	f	L_1	L_2	h	f_2	θ°	α°	r_e^{**}	Insert	Torque*
E06-STFPR2-D08	CARBIDE	0.500	0.375	0.281	5.000	1.000	0.350	-	0	-5	0.016	TP**21.5...	0.89
E08-STFPR2-D11	CARBIDE	0.688	0.500	0.406	5.000	1.062	0.475	-	0	-3	0.016	TP**21.5...	0.89
E10-STFPR2-D14	CARBIDE	0.875	0.625	0.531	7.000	1.250	0.605	-	0	-2	0.016	TP**21.5...	0.89
E12-STFPR/L3-D16	CARBIDE	1.000	0.750	0.594	7.000	1.438	0.725	-	0	-2	0.032	TP**32.5...	2.2

Metric	Material	ϕD_m	ϕD_s	f	L_1	L_2	h	f_2	θ°	α°	r_e^{**}	Insert	Torque*
A08H-STFPR/L09-D100	STEEL	10	8	5.5	100	16	7.5	0.7	5	-8	0.4	TP**0902...	0.9
A10K-STFPR/L1102-D120	STEEL	12	10	6.5	125	20	9	0.7	5	-6	0.4	TP**1102...	1.2
A12M-STFPR/L1102-D140	STEEL	14	12	7.0	150	24	11	0.6	5	-4	0.4	TP**1102...	1.2
A16Q-STFPR/L13-D180	STEEL	18	16	9	180	32	15	0.7	5	-2	0.4	TP**1303...	1.4
A20R-STFPR13-D220	STEEL	22	20	11	200	36	18	0.8	5	-2	0.4	TP**1303...	1.4
A25S-STFPR16-D270	STEEL	27	25	13.5	250	45	23	0.6	5	-1	0.4	TP**16T3...	3
E08K-STFPR/L09-D100	CARBIDE	10	8	5.5	125	22	7.5	0.7	5	-8	0.4	TP**0902...	0.9
E10M-STFPR/L1102-D120	CARBIDE	12	10	6.5	150	25	9	0.7	5	-6	0.4	TP**1102...	1.2
E12Q-STFPR/L1102-D140	CARBIDE	14	12	7	180	27	11	0.6	5	-4	0.4	TP**1102...	1.2
E16R-STFPR13-D180	CARBIDE	18	16	9	200	32	15	0.7	5	-2	0.4	TP**1303...	1.4
E20S-STFPR13-D220	CARBIDE	22	20	11	250	36	18	0.8	5	-2	0.4	TP**1303...	1.4

*Torque: Recommended torque (lbf-ft, N-m) for clamping **re: Standard corner radius

Note: When using a right or left hand insert, the right hand insert (R) is used for the left hand toolholders (STFPL ** type), and the left hand insert (L) is used for the right hand toolholders (STFPR ** type).

(1) Inserts of TPGH, TPGM and TPGA are not applicable.

SPARE PARTS



Designation	Clamping screw	Wrench
E06-STFPR2-D08	CSTB-2.5B	T-8F
E08/10-STFPR2-D...	CSTB-2.5	T-8F
E12-STFPR/L3-D16	CSTB-4S	T15-F
A08H-STFPR/L09-D100	CSTB-2.2S	T-7F
A10K-STFPR/L1102-D120	CSTB-2.5B	T-8F
A12M-STFPR/L1102-D140	CSTB-2.5	T-8F
A16Q-STFPR/L13-D180	CSTB-3S	T-9F
A20R-STFPR13-D220	CSTB-3	T-9F
A25S-STFPR16-D270	CSTB-4M	T-15F
E08K-STFPR/L09-D100	CSTB-2.2S	T-7F
E10M-STFPR/L1102-D120	CSTB-2.5B	T-8F
E12Q-STFPR/L1102-D140	CSTB-2.5	T-8F
E16R-STFPR13-D180	CSTB-3S	T-9F
E20S-STFPR13-D220	CSTB-3	T-9F

Reference pages

A/E-STFPR/L: Inserts → B138 -, CBN → B170 -, PCD → B180

STREAMJETBAR

A/E-STUPR/L

Screw-on boring bars, for positive triangle inserts

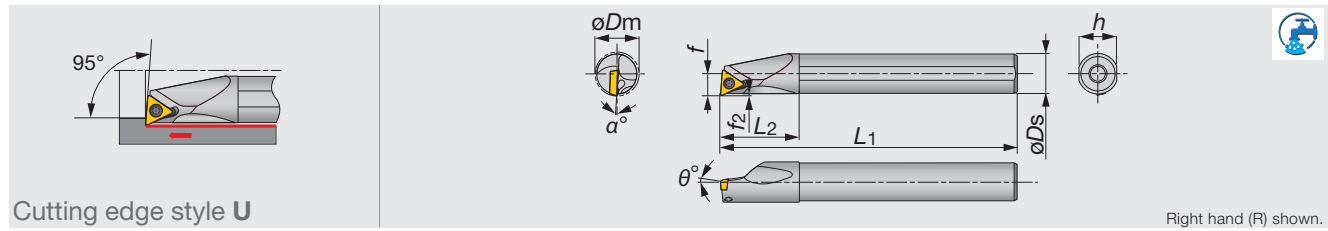

Cutting edge style U

Right hand (R) shown.

Int. Toolholder

Inch	Material	ϕD_m	ϕD_s	f	L_1	L_2	h	f_2	θ°	α°	$r_{e^{**}}$	Insert	Torque*
A05-STUPR/L7-D07	STEEL	0.438	0.313	0.250	5.00	0.625	2.880	-	5	-7	0.016	TP**73...	0.66
A06-STUPR/L2-D08	STEEL	0.500	0.375	0.281	5.00	0.750	0.350	-	5	-5	0.016	TP**21.5...	0.89
A08-STUPR/L2-D11	STEEL	0.688	0.500	0.406	5.00	1.000	0.475	-	5	-3	0.016	TP**21.5...	0.89
A10-STUPR/L2-D14	STEEL	0.875	0.625	0.531	7.00	1.250	0.600	-	5	-2	0.016	TP**21.5...	1.0
A10-STUPR/L2.5-D14	STEEL	0.875	0.625	0.531	7.00	1.250	0.600	-	5	-2	0.016	TP**22...	1.0
A12-STUPR/L3-D16	STEEL	1.000	0.750	0.594	7.00	1.437	0.725	-	5	-2	0.032	TP**32.5...	1.0
A16-STUPR/L3-D20	STEEL	1.250	1.000	0.688	7.00	1.750	0.975	-	5	0	0.032	TP**32.5...	2.2
E05-STUPR7-D07	CARBIDE	0.438	0.313	0.250	5.00	0.625	2.880	-	5	-7	0.016	TP**73...	0.66
E06-STUPR2-D08	CARBIDE	0.500	0.375	0.281	5.00	0.750	0.350	-	5	-5	0.016	TP**21.5...	0.89
E08-STUPR2-D11	CARBIDE	0.688	0.500	0.406	5.00	1.000	0.475	-	5	-3	0.016	TP**21.5...	0.89
E10-STUPR2.5-D14	CARBIDE	0.875	0.625	0.531	7.00	1.250	0.600	-	5	-2	0.016	TP**22...	1.0

*Torque: Recommended torque (lbf-ft) for clamping ** r_e : Standard corner radius

Note: When using a right or left hand insert, the right hand insert (R) is used for the left hand toolholders (STUPL ** type), and the left hand insert (L) is used for the right hand toolholders (STUPR ** type).

SPARE PARTS



Designation	Clamping screw	Wrench
A05-STUPR/L7-D07	CSTB-2.2S	T-7F
A06-STUPR/L2-D08	CSTB-2.5S	T-8F
A08-STUPR/L2-D11	CSTB-2.5B	T-8F
A10-STUPR/L2-D14	CSTB-2.5	T-8F
A10-STUPR/L2.5-D14	CSTB-2.5	T-8F
A12-STUPR/L3-D16	CSTB-4M	T-15F
A16-STUPR/L3-D20	CSTB-4M	T-15F
E05-STUPR7-D07	CSTB-2.2S	T-7F
E06-STUPR2-D08	CSTB-2.5S	T-8F
E08-STUPR2-D11	CSTB-2.5B	T-8F
E10-STUPR2.5-D14	CSTB-3	T-9F

Reference pages

A/E-STUPR/L: Inserts → B138 -, CBN → B170 -, PCD → B180



Metric	Material	øDm	øDs	f	L1	L2	h	f2	θ°	α°	re**	Insert	Torque*
A07G-STUPR/L07-D080	STEEL	8	7	4	90	12	6.75	0.4	5	-10	0.4	TP**0701...	0.9
A08H-STUPR/L07-D080	STEEL	8	8	4	100	19.5	7.5	0.5	5	-10	0.4	TP**0701...	0.9
A08H-STUPR/L09-D100	STEEL	10	8	5.5	100	16	7.5	0.6	5	-8	0.4	TP**0902...(1)	0.9
A10F-STUPR1102-D120	STEEL	12	10	6.5	80	20	9	1.4	5	-6	0.4	TP**1102...(1)	1.2
A10K-STUPR/L1102-D120	STEEL	12	10	6.5	125	20	9	0.7	5	-6	0.4	TP**1102...(1)	1.2
A10K-STUPR/L1103-D120	STEEL	12	10	6.5	125	20	9	0.6	5	-10	0.4	TP**1103...(1)	1.4
A12H-STUPR1102-D140	STEEL	14	12	7	100	24	11	0.9	5	-4	0.4	TP**1102...(1)	1.2
A12M-STUPR/L1102-D140	STEEL	14	12	7	150	24	11	0.7	5	-4	0.4	TP**1102...(1)	1.2
A12M-STUPR/L1103-D140	STEEL	14	12	7	150	24	11	0.6	5	-6	0.4	TP**1103...(1)	1.4
A12H-STUPR1102-D160	STEEL	16	12	9	100	24	11	0.6	5	-3	0.4	TP**1102...(1)	1.2
A12M-STUPR/L1102-D160	STEEL	16	12	9	150	24	11	0.6	5	-3	0.4	TP**1102...(1)	1.2
A16K-STUPR13-D180	STEEL	18	16	9	125	32	15	0.9	5	-3	0.4	TP**1303...(1)	1.4
A16Q-STUPR/L1103-D180	STEEL	18	16	9	180	32	15	0.8	5	-4	0.4	TP**1103...(1)	1.4
A16Q-STUPR/L13-D180	STEEL	18	16	9	180	32	15	0.6	5	-3	0.4	TP**1303...(1)	1.4
A16K-STUPR13-D200	STEEL	20	16	11	125	32	15	0.6	5	-3	0.4	TP**1303...(1)	1.4
A16Q-STUPR/L13-D200	STEEL	20	16	11	180	32	15	0.6	5	-3	0.4	TP**1303...(1)	1.4
A20R-STUPR/L1103-D220	STEEL	22	20	11	200	36	18	0.7	5	-2	0.4	TP**1103...(1)	1.4
A20R-STUPR/L13-D220	STEEL	22	20	11	200	36	18	0.7	5	-2	0.4	TP**1303...(1)	1.4
A25S-STUPR/L16-D270	STEEL	27	25	13.5	250	45	23	0.5	5	-1	0.8	TP**16T3...(1)	3
A32T-STUPR/L16-D340	STEEL	34	32	17	300	50	30	0.7	5	0	0.8	TP**16T3...	3
E07H-STUPR/L07-D080	CARBIDE	8	7	4	100	14	6.75	0.3	5	-10	0.4	TP**0701...	0.9
E08G-STUPR07-D080	CARBIDE	8	8	4	90	44.5	7.5	0.5	5	-10	0.4	TP**0701...	0.9
E08K-STUPR/L07-D080	CARBIDE	8	8	4	125	44.5	7.5	0.5	5	-10	0.4	TP**0701...	0.9
E08G-STUPR09-D100	CARBIDE	10	8	5.5	90	22	7	0.6	5	-8	0.4	TP**0902...(1)	0.9
E08K-STUPR/L09-D100	CARBIDE	10	8	5.5	125	22	7	0.6	5	-8	0.4	TP**0902...(1)	0.9
E10F-STUPR1102-D120	CARBIDE	12	10	6.5	80	25	9	0.5	5	-6	0.4	TP**1102...(1)	1.2
E10H-STUPR1102-D120	CARBIDE	12	10	6.5	100	25	9	0.6	5	-6	0.4	TP**1102...(1)	1.2
E10M-STUPR/L1102-D120	CARBIDE	12	10	6.5	150	25	9	0.6	5	-6	0.4	TP**1102...(1)	1.2
E10M-STUPR/L1103-D120	CARBIDE	12	10	6.5	150	25	9	0.7	5	-10	0.4	TP**1103...(1)	1.4
E12G-STUPR1102-D140	CARBIDE	14	12	7	90	27	11	0.9	5	-4	0.4	TP**1102...(1)	1.2
E12J-STUPR1102-D140	CARBIDE	14	12	7	110	27	11	0.6	5	-4	0.4	TP**1102...(1)	1.2
E12Q-STUPR/L1102-D140	CARBIDE	14	12	7	180	27	11	0.6	5	-4	0.4	TP**1102...(1)	1.2
E12Q-STUPR/L1103-D140	CARBIDE	14	12	7	180	27	11	0.7	5	-6	0.4	TP**1103...(1)	1.4
E12G-STUPR1102-D160	CARBIDE	16	12	9	90	27	11	0.6	5	-3	0.4	TP**1102...(1)	1.2
E12J-STUPR1102-D160	CARBIDE	16	12	9	110	27	11	0.6	5	-3	0.4	TP**1102...(1)	1.2
E12Q-STUPR/L1102-D160	CARBIDE	16	12	9	180	27	11	0.6	5	-3	0.4	TP**1102...(1)	1.2
E16H-STUPR13-D180	CARBIDE	18	16	9	100	32	15	0.9	5	-3	0.4	TP**1303...(1)	1.4
E16R-STUPR/L1103-D180	CARBIDE	18	16	9	200	32	15	0.8	5	-3	0.4	TP**1103...(1)	1.4
E16L-STUPR13-D180	CARBIDE	18	16	9	130	32	15	0.6	5	-3	0.4	TP**1303...(1)	1.4
E16R-STUPR/L13-D180	CARBIDE	18	16	9	200	32	15	0.6	5	-3	0.4	TP**1303...(1)	1.4
E16H-STUPR13-D200	CARBIDE	20	16	11	100	32	15	0.6	5	-3	0.4	TP**1303...(1)	1.4
E16L-STUPR13-D200	CARBIDE	20	16	11	130	32	15	0.6	5	-3	0.4	TP**1303...(1)	1.4
E16R-STUPL13-D200	CARBIDE	20	16	11	200	32	15	0.6	5	-3	0.4	TP**1303...(1)	1.4
E20S-STUPR1103-D220	CARBIDE	22	20	11	250	36	18	0.7	5	-2	0.4	TP**1103...(1)	1.4
E20S-STUPR13-D220	CARBIDE	22	20	11	250	36	18	0.6	5	-2	0.4	TP**1303...(1)	1.4
E25T-STUPR16-D270	CARBIDE	27	25	13.5	300	45	23	0.5	5	-1	0.8	TP**16T3...	3

*Torque: Recommended torque (N·m) for clamping **re: Standard corner radius

Note: When using a right or left hand insert, the right hand insert (R) is used for the left hand toolholders (STUPL ** type), and the left hand insert (L) is used for the right hand toolholders (STUPR ** type).

(1) Inserts of TPGH, TPGM and TPGA are not applicable.

SPARE PARTS

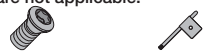

Designation	Clamping screw	Wrench
A07/08-STUPR/L07/09-D...	CSTB-2.2L038	T-7F
A10*-STUPR/L1102-D120	CSTB-2.5S	T-8F
A12*-STUPR/L1102-D...	CSTB-2.5B	T-8F
A12M-STUPR/L1103-D140	CSTB-3L050	T-9F
A16*-STUPR/L13-D...	CSTB-3S	T-9F
A20R-STUPR/L13-D220	CSTB-3	T-9F
A*-STUPR/L16-D...	CSTB-4M	T-15F
E07/08-STUPR/L07/09-D...	CSTB-2.2L038	T-7F
E10*-STUPR/L1102-D120	CSTB-2.5S	T-8F
E12*-STUPR/L1102-D...	CSTB-2.5B	T-8F
E*-STUPR/L1103-D...	CSTB-3L050	T-9F
E16*-STUPR/L13-D...	CSTB-3S	T-9F
E20S-STUPR13-D220	CSTB-3	T-9F
E25T-STUPR16-D270	CSTB-4M	T-15F

Reference pages

A/E-STUPR/L: Inserts → **B138 -**, CBN → **B170 -**, PCD → **B180**

Int. Toolholder

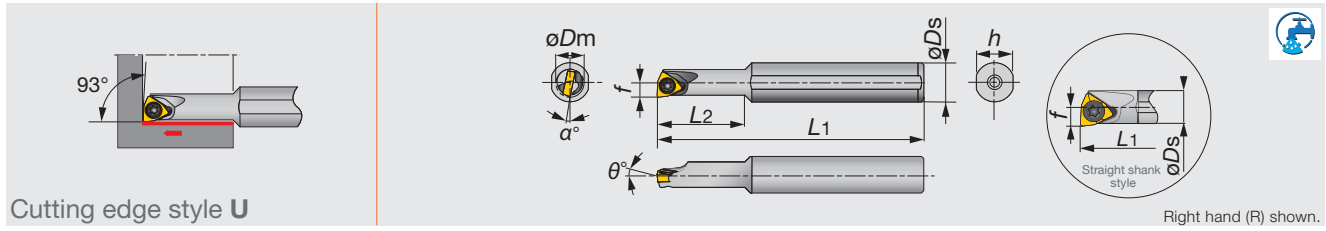

Metric	Material	ϕD_m	ϕD_s	f	L_1	L_2	h	θ°	α°	r_{ϵ}^{**}	Insert	Torque*
A05F-SWUBR/L03-D060	STEEL	6	5	3	80	9	4.8	0	-13	0.4	WB**0301...	0.6
A06G-SWUBR/L03-D070	STEEL	7	6	3.5	90	11	5.75	0	-12	0.4	WB**0301...	0.6
A07G-SWUBR/L03-D080	STEEL	8	7	4	90	12	6.75	0	-11	0.4	WB**0301...	0.6
A08H-SWUBR03-D060	STEEL	6	8	3.1	100	18	7.5	0	-12	0.4	WB**0301...	0.6
A08H-SWUBR03-D070	STEEL	7	8	3.6	100	20	7.5	0	-12	0.4	WB**0301...	0.6
E05G-SWUBR/L03-D060	CARBIDE	6	5	3	90	10	4.8	0	-13	0.4	WB**0301...	0.6
E06H-SWUBR/L03-D070	CARBIDE	7	6	3.5	100	12	5.75	0	-12	0.4	WB**0301...	0.6
E07H-SWUBR/L03-D080	CARBIDE	8	7	4	100	14	6.75	0	-11	0.4	WB**0301...	0.6
E08K-SWUBR03-D060	CARBIDE	6	8	3.1	125	30	7.5	0	-12	0.4	WB**0301...	0.6
E08K-SWUBR03-D070	CARBIDE	7	8	3.6	125	40	7.5	0	-12	0.4	WB**0301...	0.6

*Torque: Recommended torque (N-m) for clamping ** r_{ϵ} : Standard corner radius
 Note: When using a right or left hand insert, the right hand insert (R) is used for the left hand toolholders (SWUBL** type), and the left hand insert (L) is used for the right hand toolholders (SWUBR** type).

SPARE PARTS

Designation	Clamping screw	Wrench
A/E**-SWUBR/L...	CSTB-2	T-6F

Reference pages

A/E-SWUBR/L: Inserts → B153

STREAMJETBAR

A/E-SDUCR/L

Screw-on boring bars, for positive 55° rhombic inserts

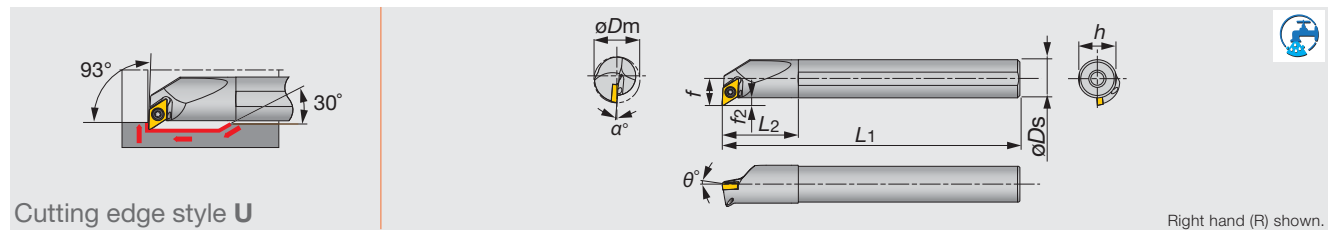

Cutting edge style U

Right hand (R) shown.

Inch	Material	ϕD_m	ϕD_s	f	L_1	L_2	h	f_2	θ°	α°	r_{ϵ}^{**}	Insert	Torque*
A06-SDUCR2-D10	STEEL	0.625	0.375	0.406	5.000	0.750	0.350	0.218	0	-8	0.016	DC**21.5...	0.89
A08-SDUCR/L2-D11	STEEL	0.688	0.500	0.406	5.000	1.000	0.475	0.156	0	-6	0.016	DC**21.5...	0.89
A10-SDUCR2-D14	STEEL	0.875	0.625	0.531	7.000	1.250	0.600	0.218	0	-4	0.016	DC**21.5...	0.89
A12-SDUCR/L3-D16	STEEL	1.000	0.750	0.594	10.000	1.500	0.700	0.218	0	-2	0.032	DC**32.5...	2.2
E06-SDUCR2-D10	CARBIDE	0.625	0.375	0.406	5.000	1.000	0.375	0.218	0	-7	0.016	DC**21.5...	0.89
E08-SDUCR2-D11	CARBIDE	0.688	0.500	0.406	5.000	1.062	0.475	0.156	0	-6	0.016	DC**21.5...	0.89
E10-SDUCR2-D14	CARBIDE	0.875	0.625	0.531	7.000	1.250	0.600	0.218	0	-4	0.016	DC**21.5...	0.89
E12-SDUCR/L3-D16	CARBIDE	1.000	0.750	0.594	7.000	1.438	0.750	0.218	0	-5	0.032	DC**32.5...	2.2

Metric	Material	ϕD_m	ϕD_s	f	L_1	L_2	h	f_2	θ°	α°	r_{ϵ}^{**}	Insert	Torque*
A10K-SDUCR/L07-D130	STEEL	13	10	7	125	20	9	2	0	-10	0.4	DC**0702...	1.2
A12M-SDUCR/L07-D160	STEEL	16	12	9.3	150	24	11	3.3	0	-6	0.4	DC**0702...	1.2
A16Q-SDUCR/L07-D200	STEEL	20	16	11.3	180	32	15	3.3	0	-5	0.4	DC**0702...	1.2
A20R-SDUCR/L11-D270	STEEL	27	20	16.1	200	36	18	6.1	0	-5	0.8	DC**11T3...	3
A25S-SDUCR/L11-D320	STEEL	32	25	18.6	250	45	23	6.1	0	-4	0.8	DC**11T3...	3
E10H-SDUCR07-D130	CARBIDE	13	10	7	100	25	9	1.9	5	-3.5	0.4	DC**0702...	1.2
E10M-SDUCR/L07-D130	CARBIDE	13	10	7	150	25	9	2	0	-10	0.4	DC**0702...	1.2
E12J-SDUCR07-D160	CARBIDE	16	12	9.3	110	27	11	3.2	0	-6	0.4	DC**0702...	1.2
E12Q-SDUCR/L07-D160	CARBIDE	16	12	9.3	180	27	11	3.3	0	-6	0.4	DC**0702...	1.2
E16L-SDUCR07-D200	CARBIDE	20	16	11.3	130	32	15	3.2	0	-5	0.4	DC**0702...	1.2
E16R-SDUCR/L07-D200	CARBIDE	20	16	11.3	200	32	15	3.3	0	-5	0.4	DC**0702...	1.2
E20S-SDUCR11-D270	CARBIDE	27	20	16.1	250	36	18	6.1	0	-5	0.8	DC**11T3...	3

*Torque: Recommended torque (lbf-ft, N-m) for clamping ** r_{ϵ} : Standard corner radius

Note: When using a right or left hand insert, the right hand insert (R) is used for the left hand toolholders (SDUCL** type), and the left hand insert (L) is used for the right hand toolholders (SDUCR** type).

SPARE PARTS



Designation	Clamping screw	Wrench
A06-SDUCR2-D10	CSTB-2.5	T-8F
A08-SDUCR/L2-D11	CSTB-2.5B	T-8F
A10-SDUCR2-D14	CSTB-2.5	T-8F
A12-SDUCR/L3-D16	CSTB-3.5	T-15F
E06-SDUCR2-D10	CSTB-2.5	T-8F
E08-SDUCR2-D11	CSTB-2.5B	T-8F
E10-SDUCR2-D14	CSTB-2.5	T-8F
E12-SDUCR/L3-D16	CSTB-4S	T15-F
A1**-SDUCR/L07-D1*0	CSTB-2.5S	T-8F
A16Q-SDUCR/L07-D200	CSTB-2.5	T-8F
A2**-SDUCR/L11-D**0	CSTB-4S	T-15F
E1**-SDUCR/L07-D1*0	CSTB-2.5S	T-8F
E16*-SDUCR/L07-D200	CSTB-2.5	T-8F
E20S-SDUCR11-D270	CSTB-4S	T-15F

Reference pages

A/E-SDUCR/L: Inserts → B116 -, CBN → B170 -, PCD → B179

STREAMJETBAR

A/E-SVUBR/L

Screw-on boring bars, for positive 35° rhombic inserts

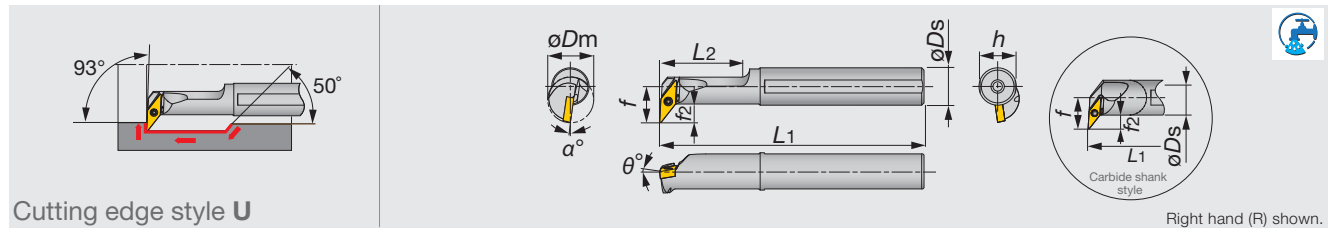

Cutting edge style U

Right hand (R) shown.

Inch	Material	øDm	øDs	f	L1	L2	h	f2	θ°	α°	re**	Insert	Torque*
A12-SVUBR2-D16	STEEL	1.000	0.750	0.594	10.000	1.425	0.725	0.218	-0	-6	0.016	VB**22...	0.89
Metric	Material	øDm	øDs	f	L1	L2	h	f2	θ°	α°	re**	Insert	Torque*
A16Q-SVUBR/L11-D200	STEEL	20	16	15.5	180	35	15	8	0	-8	0.4	VB**1103...	1.2
A20R-SVUBR/L11-D250	STEEL	25	20	17.5	200	40	19	8	0	-7	0.4	VB**1103...	1.2
A25S-SVUBR/L16-D320	STEEL	32	25	20.5	250	50	23	8.5	0	-6	0.8	VB**1604...	3
E16R-SVUBR/L11-D245	CARBIDE	24.5	16	16	200	-	15	8	0	-8	0.4	VB**1103...	1.2
E20S-SVUBR/L11-D285	CARBIDE	28.5	20	18	250	-	19	8	0	-7	0.4	VB**1103...	1.2
E25T-SVUBR/L16-D340	CARBIDE	34	25	21	300	-	23	8.5	0	-6	0.8	VB**1604...	3

*Torque: Recommended torque (lbf-ft, N-m) for clamping **re: Standard corner radius

Note: When using a right or left hand insert, the right hand insert (R) is used for the left hand toolholders (SVUBL** type), and the left hand insert (L) is used for the right hand toolholders (SVUBR** type).

SPARE PARTS



Designation	Clamping screw	Wrench
A12-SVUBR2-D16	CSTB-2.5	T-8F
A**-SVUBR/L11-D2*0	CSTB-2.5	T-8F
A25S-SVUBR/L16-D320	CSTB-3.5	T-15F
E**-SVUBR/L11-D2*5	CSTB-2.5	T-8F
E25T-SVUBR/L16-D340	CSTB-3.5	T-15F

Reference pages

A/E-SVUBR/L: Inserts → B147 -, CBN → B171 -

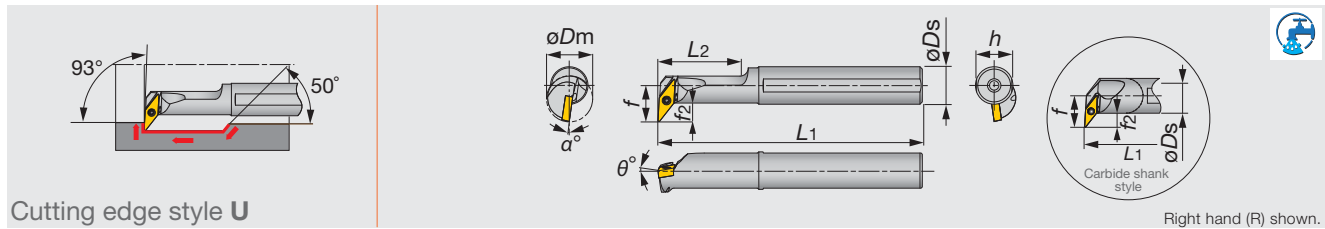

Cutting edge style U

Right hand (R) shown.

Inch	Material	ϕD_m	ϕD_s	f	L_1	L_2	h	f_2	θ°	α°	r_e^{**}	Insert	Torque*
A10-SVUCR6-D14	STEEL	0.875	0.625	0.531	7.000	1.250	0.600	0.218	0	-5	0.016	VC**63...	0.44
A12-SVUCR2-D16	STEEL	1.000	0.750	0.594	10.000	1.420	0.725	0.218	0	-5	0.016	VC**22...	1.0

Metric	Material	ϕD_m	ϕD_s	f	L_1	L_2	h	f_2	θ°	α°	r_e^{**}	Insert	Torque*
A12M-SVUCR/L08-D160	STEEL	16	12	11	150	30	11	5.5	0	-8	0.4	VC**0802...	0.6
A25S-SVUCR/L16-D320	STEEL	32	25	19	250	45	23	6.5	0	-5	0.8	VC**1604...	3
E12Q-SVUCR/L08-D180	CARBIDE	18	12	11.5	180	-	11	5.5	0	-8	0.4	VC**0802...	0.6
E25T-SVUCR/L16-D320	CARBIDE	32	25	19	300	-	23	6.5	0	-5	0.8	VC**1604...	3

*Torque: Recommended torque (N-m) for clamping ** r_e : Standard corner radius

Note: When using a right or left hand insert, the right hand insert (R) is used for the left hand toolholders (SVUCL** type), and the left hand insert (L) is used for the right hand toolholders (SVUCR** type).

SPARE PARTS



Designation	Clamping screw	Wrench
A10-SVUCR6-D14	CSTB-2L	T-6F
A12-SVUCR2-D16	CSTB-2.5	T-8F
A12M-SVUCR/L08-D160	CSTB-2L	T-6F
A25S-SVUCR/L16-D320	CSTB-3.5	T-15F
E12Q-SVUCR/L08-D180	CSTB-2L	T-6F
E25T-SVUCR/L16-D320	CSTB-3.5	T-15F

STREAMJETBAR

A/E-SDQCR/L

Screw-on boring bars, for positive 55° rhombic inserts

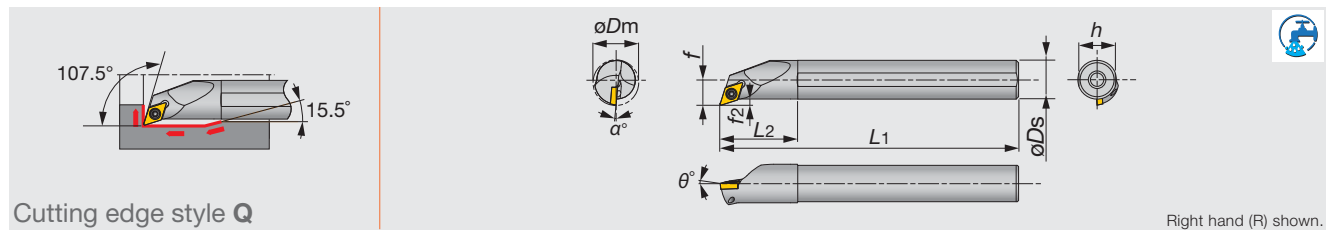

Cutting edge style Q

Right hand (R) shown.

Inch	Material	ϕD_m	ϕD_s	f	L_1	L_2	h	f_2	θ°	α°	$r_{e^{**}}$	Insert	Torque*
A06-SDQCR2-D10	STEEL	0.625	0.375	0.406	5.000	0.750	0.350	-	0	-7	0.016	DC**21.5...	0.89
A08-SDQCR2-D11	STEEL	0.688	0.500	0.406	5.000	1.000	0.475	-	0	-6	0.016	DC**21.5...	0.89
A10-SDQCR2-D14	STEEL	0.875	0.625	0.531	7.000	1.250	0.600	-	0	-4	0.016	DC**21.5...	0.89

Metric	Material	ϕD_m	ϕD_s	f	L_1	L_2	h	f_2	θ°	α°	$r_{e^{**}}$	Insert	Torque*
A10K-SDQCR/L07-D130	STEEL	13	10	7.6	125	20	9	2.6	0	-8	0.4	DC**0702...	1.2
A12M-SDQCR/L07-D160	STEEL	16	12	8.6	150	24	11	2.6	0	-6	0.4	DC**0702...	1.2
A16Q-SDQCR/L07-D200	STEEL	20	16	10.6	180	32	15	2.6	0	-5	0.4	DC**0702...	1.2
A20R-SDQCR/L11-D250	STEEL	25	20	13.7	200	36	18	3.7	0	-7	0.8	DC**11T3...	3
A25S-SDQCR/L11-D300	STEEL	30	25	16.2	250	45	23	3.7	0	-4	0.8	DC**11T3...	3
E10H-SDQCR07-D130	CARBIDE	13	10	7.6	100	25	9	2.5	0	-8	0.4	DC**0702...	1.2
E10M-SDQCR/L07-D130	CARBIDE	13	10	7.6	150	25	9	2.6	0	-8	0.4	DC**0702...	1.2
E12J-SDQCR07-D160	CARBIDE	16	12	8.6	110	27	11	2.5	0	-6	0.4	DC**0702...	1.2
E12Q-SDQCR/L07-D160	CARBIDE	16	12	8.6	180	27	11	2.6	0	-6	0.4	DC**0702...	1.2
E16L-SDQCR07-D200	CARBIDE	20	16	10.6	130	32	15	2.5	0	-5	0.4	DC**0702...	1.2
E16R-SDQCR/L07-D200	CARBIDE	20	16	10.6	200	32	15	2.6	0	-5	0.4	DC**0702...	1.2
E20S-SDQCR/L11-D250	CARBIDE	25	20	13.7	250	36	18	3.7	0	-7	0.8	DC**11T3...	3

*Torque: Recommended torque (lbf-ft, N-m) for clamping **re: Standard corner radius

Note: When using a right or left hand insert, the right hand insert (R) is used for the left hand toolholders (SDQCL** type), and the left hand insert (L) is used for the right hand toolholders (SDQCR** type).

SPARE PARTS



Designation	Clamping screw	Wrench
A**-SDQCR2-D...	CSTB-2.5B	T-8F
A1**-SDQCR/L07-D**0	CSTB-2.5S	T-8F
A2**-SDQCR/L11-D**0	CSTB-4S	T-15F
E1**-SDQCR/L07-D**0	CSTB-2.5S	T-8F
E20S-SDQCR/L11-D250	CSTB-4S	T-15F

Reference pages

A/E-SDQCR/L: Inserts → B116 -, CBN → B170 -, PCD → B179

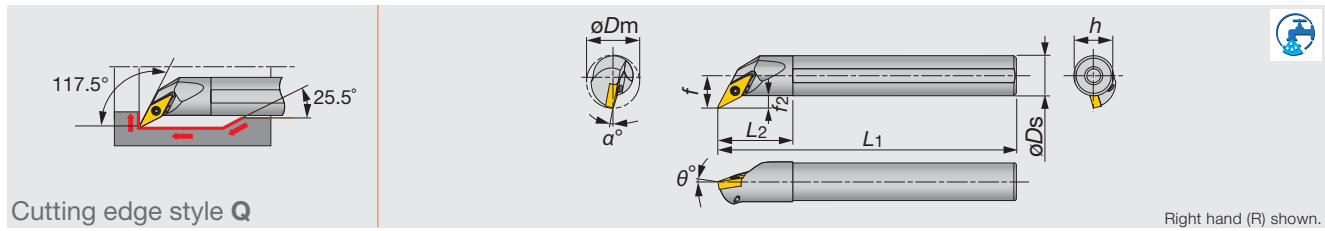

Inch	Material	øDm	øDs	f	L1	L2	h	f2	θ°	α°	rε**	Insert	Torque*
A10-SVQBR2-D16	STEEL	1.000	0.625	0.500	7.000	1.250	0.600	0.188	-5	-6	0.016	VB**22...	0.89
Metric	Material	øDm	øDs	f	L1	L2	h	f2	θ°	α°	rε**	Insert	Torque*
A12M-SVQBR/L11-D170	STEEL	17	12	10.5	150	24	11	4.5	-5	-10	0.4	VB**1103...	1.2
A16Q-SVQBR/L11-D215	STEEL	21.5	16	13	180	30	15	5	-5	-8	0.4	VB**1103...	1.2
A20R-SVQBR/L11-D255	STEEL	25.5	20	15	200	36	18	5	-5	-6	0.4	VB**1103...	1.2
A25S-SVQBR/L16-D305	STEEL	30.5	25	17.5	250	45	23	5	-5	-8	0.8	VB**1604...	3
E12Q-SVQBR/L11-D170	CARBIDE	17	12	10.5	180	27	11	4.5	-5	-10	0.4	VB**1103...	1.2
E16R-SVQBR/L11-D215	CARBIDE	21.5	16	13	200	32	15	5	-5	-8	0.4	VB**1103...	1.2
E20S-SVQBR/L11-D255	CARBIDE	25.5	20	15	250	36	18	5	-5	-6	0.4	VB**1103...	1.2
E25T-SVQBR/L16-D305	CARBIDE	30.5	25	17.5	300	45	23	5	-5	-8	0.8	VB**1604...	3

*Torque: Recommended torque (lbf-ft, N-m) for clamping **rε: Standard corner radius

Note: When using a right or left hand insert, the right hand insert (R) is used for the left hand toolholders (SVQBL type), and the left hand insert (L) is used for the right hand toolholders (SVQBR type).

SPARE PARTS



Designation	Clamping screw	Wrench
A10-SVQBR2-D16	CSTB-2.5	T-8F
A**-SVQBR/L11-D...	CSTB-2.5	T-8F
A25S-SVQBR/L16-D305	CSTB-3.5	T-15F
E**-SVQBR/L11-D...	CSTB-2.5	T-8F
E25T-SVQBR/L16-D305	CSTB-3.5	T-15F

Reference pages

A/E-SVQBR/L: Inserts → B147 -, CBN → B171 -



Int. Toolholder

STREAMJETBAR

A/E-SVQCR/L

Screw-on boring bars, for positive 35° rhombic inserts

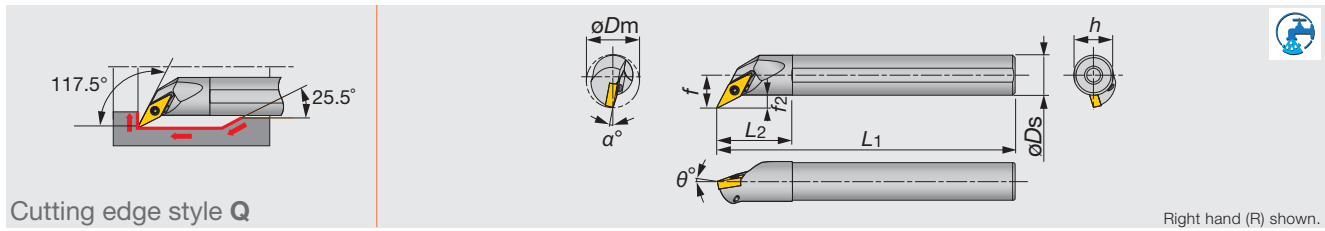

Cutting edge style Q

Right hand (R) shown.

Inch	Material	ϕD_m	ϕD_s	f	L_1	L_2	h	f_2	θ°	α°	r_{ϵ}^{**}	Insert	Torque*
A08-SVQCR6-D11	STEEL	0.688	0.500	0.375	5.000	1.000	0.475	0.125	-5	-6	0.016	VC**63...	0.44
A10-SVQCR2-D16	STEEL	1.000	0.625	0.500	10.000	1.250	0.600	0.188	-5	-4	0.016	VC**22...	0.89

Metric	Material	ϕD_m	ϕD_s	f	L_1	L_2	h	f_2	θ°	α°	r_{ϵ}^{**}	Insert	Torque*
A10K-SVQCR/L08-D135	STEEL	13.5	10	8	125	20	9	3	-5	-8	0.4	VC**0802...	0.6
A16Q-SVQCR/L11-D215	STEEL	21.5	16	13	180	30	15	4.9	-5	-8	0.4	VC**1103...	1.2
E10M-SVQCR/L08-D135	CARBIDE	13.5	10	8	150	25	9	3	-5	-8	0.4	VC**0802...	0.6
E16R-SVQCR/L11-D215	CARBIDE	21.5	16	13	200	32	15	4.9	-5	-8	0.4	VC**1103...	1.2

*Torque: Recommended torque (lbf-ft, N-m) for clamping **r ϵ : Standard corner radius

Note: When using a right or left hand insert, the right hand insert (R) is used for the left hand toolholders (SVQCL ** type), and the left hand insert (L) is used for the right hand toolholders (SVQCR ** type).

SPARE PARTS



Designation	Clamping screw	Wrench
A08-SVQCR6-D11	CSTB-2L	T-6F
A10-SVQCR2-D16	CSTB-2.5	T-8F
A10K-SVQCR/L08-D135	CSTB-2L	T-6F
A16Q-SVQCR/L11-D215	CSTB-2.5	T-8F
E10M-SVQCR/L08-D135	CSTB-2L	T-6F
E16R-SVQCR/L11-D215	CSTB-2.5	T-8F

Reference pages

A/E-SVQCR/L: Inserts → B149 -

STREAMJETBAR

A/E-SDZCR/L

Screw-on boring bars, for positive 55° rhombic inserts

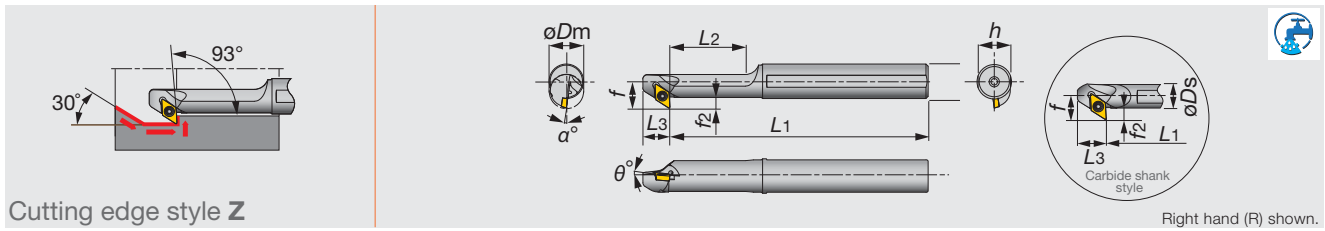

Cutting edge style Z

Right hand (R) shown.

Inch	Material	ϕD_m	ϕD_s	f	L_1	L_2	L_3	h	f_2	θ°	α°	r_{ϵ}^{**}	Insert	Torque*
A10-SDZCR2-D14	STEEL	0.875	0.625	0.531	7.000	1.250	-	0.600	0.218	-	-	0.016	DC**21.5...	0.89
Metric	Material	ϕD_m	ϕD_s	f	L_1	L_2	L_3	h	f_2	θ°	α°	r_{ϵ}^{**}	Insert	Torque*
A12M-SDZCR/L07-D140	STEEL	14	12	10.5	150	30	12.5	11	4.5	0	-9	0.4	DC**0702...	1.2
A16Q-SDZCR/L07-D160	STEEL	16	16	12.5	180	35	12.5	15	4.5	0	-8	0.4	DC**0702...	1.2
A20R-SDZCR/L11-D200	STEEL	20	20	15.5	200	40	15.0	18	5.5	0	-8	0.8	DC**11T3...	3
A25S-SDZCR/L11-D250	STEEL	25	25	18	250	50	15	23	5.5	0	-6	0.8	DC**11T3...	3
E12Q-SDZCR/L07-D180	CARBIDE	18	12	10.5	180	-	12.5	11	4.5	0	-8	0.4	DC**0702...	1.2
E16R-SDZCR/L07-D220	CARBIDE	22	16	12.5	200	-	12.5	15	4.5	0	-6	0.4	DC**0702...	1.2

*Torque: Recommended torque (lbf-ft, N-m) for clamping **re: Standard corner radius

Note: When using a right or left hand insert, the right hand insert (R) is used for the right hand toolholders (SDZCR ** type), and the left hand insert (L) is used for the left hand toolholders (SDZCL ** type).

SPARE PARTS



Designation	Clamping screw	Wrench
A10-SDZCR2-D14	CSTB-2.5	T-8F
A1**-SDZCR/L07-D1*0	CSTB-2.5	T-8F
A2**-SDZCR/L11-D2*0	CSTB-4S	T-15F
E1**-SDZCR/L07-D**0	CSTB-2.5	T-8F

Int. Toolholder

Reference pages

A/E-SDZCR/L: Inserts → B116 -, CBN → B170 -, PCD → B179

STREAMJETBAR

A-SVZBR/L

Screw-on boring bars, for positive 35° rhombic inserts

Int. Toolholder

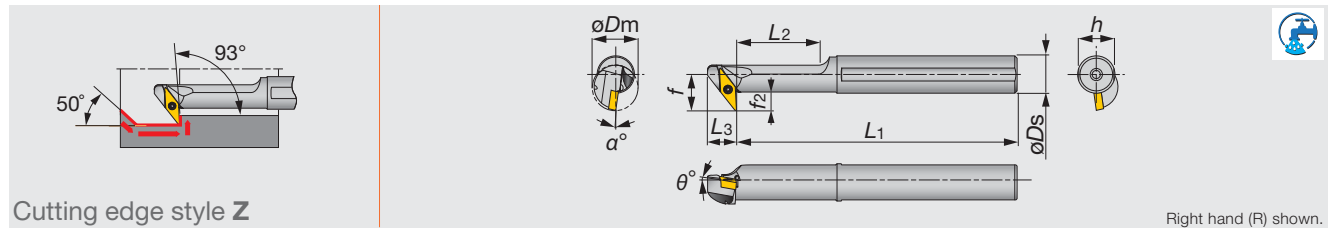

Cutting edge style Z

Right hand (R) shown.

Inch	Material	ϕD_m	ϕD_s	f	L_1	L_2	L_3	h	f_2	θ°	α°	r_{ϵ}^{**}	Insert	Torque*
A12-SVZBR2-D16	STEEL	1.000	0.750	0.594	10.000	1.430	-	0.725	0.218	0	-5	0.016	VB**22...	0.89
Metric	Material	ϕD_m	ϕD_s	f	L_1	L_2	L_3	h	f_2	θ°	α°	r_{ϵ}^{**}	Insert	Torque*
A16Q-SVZBR/L11-D200	STEEL	20	16	15.5	180	35	12.5	15	8	0	-8	0.4	VB**1103...	1.2
A20R-SVZBR/L11-D250	STEEL	25	20	17.5	200	40	12.5	18	8	0	-7	0.4	VB**1103...	1.2
A25S-SVZBR/L16-D320	STEEL	32	25	24	250	50	17.5	23	12	0	-6	0.8	VB**1604...	3
A32T-SVZBR/L16-D400	STEEL	40	32	27.5	300	72	17.5	30	12	0	-5	0.8	VB**1604...	3

*Torque: Recommended torque (lbf-ft, N-m) for clamping **re: Standard corner radius

Note: When using a right or left hand insert, the right hand insert (R) is used for the right hand toolholders (SVZBR type), and the left hand insert (L) is used for the left hand toolholders (SVZBL type).

SPARE PARTS

Designation	Clamping screw	Wrench
A12-SVZBR2-D16	CSTB-2.5	T-8F
A**-SVZBR/L11-D**	CSTB-2.5	T-8F
A25S-SVZBR/L16-D320	CSTB-3.5	T-15F
A32T-SVZBR/L16-D400	CSTB-3.5L	T-15F

STREAMJETBAR

A-SVZCR/L

Screw-on boring bars, for positive 35° rhombic inserts

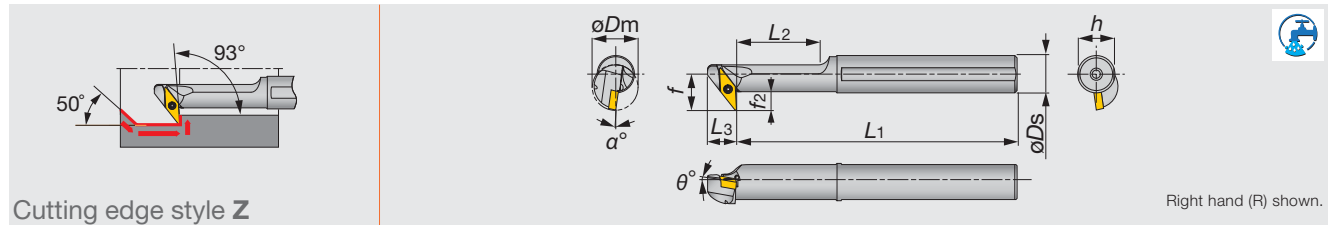

Cutting edge style Z

Right hand (R) shown.

Inch	Material	ϕD_m	ϕD_s	f	L_1	L_2	L_3	h	f_2	θ°	α°	r_{ϵ}^{**}	Insert	Torque*
A08-SVZCR6-D12	STEEL	0.750	0.500	0.438	5.000	1.000	-	0.475	0.188	0	-6	0.016	VC**63...	0.44
A12-SVZCR2-D16	STEEL	1.000	0.750	0.593	10.000	1.425	-	0.725	0.218	0	-7	0.016	VC**22...	0.89
Metric	Material	ϕD_m	ϕD_s	f	L_1	L_2	L_3	h	f_2	θ°	α°	r_{ϵ}^{**}	Insert	Torque*
A12M-SVZCR/L08-D160	STEEL	16	12	11	150	30	10	11	5.5	0	-8	0.4	VC**0802...	0.6

*Torque: Recommended torque (lbf-ft, N-m) for clamping **re: Standard corner radius

Note: When using a right or left hand insert, the right hand insert (R) is used for the right hand toolholders (SVZCR ** type), and the left hand insert (L) is used for the left hand toolholders (SVZCL ** type).

SPARE PARTS

Designation	Clamping screw	Wrench
A08-SVZCR6-D12	CSTB-2L	T-6F
A12-SVZCR2-D16	CSTB-2.5	T-8F
A12M-SVZCR/L08-D160	CSTB-2L	T-6F

Reference pages

A-SVZBR/L: Inserts → B147 -, CBN → B171 -

A-SVZCR/L: Inserts → B149 -

STREAMJETBAR

A/E-SEZPR/L

Screw-on boring bars, for positive 75° rhombic inserts

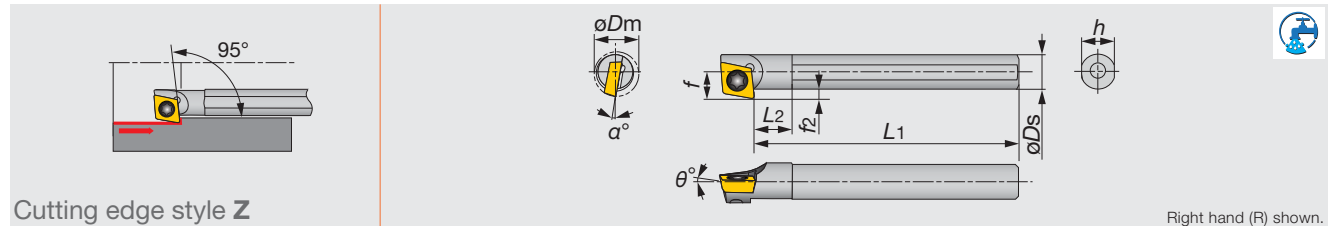

Cutting edge style Z

Right hand (R) shown.

Metric	Material	ϕD_m	ϕD_s	f	L_1	L_2	h	f_2	θ°	α°	r_c^{**}	Insert	Torque*
A04F-SEZPR/L03-D055	STEEL	5.5	4	3.2	80	4	3.8	1.2	0	-8	0.2	EP**03X1...	0.6
A05F-SEZPR/L03-D065	STEEL	6.5	5	3.7	80	5	4.8	1.2	0	-6	0.2	EP**03X1...	0.6
E04G-SEZPR/L03-D055	CARBIDE	5.5	4	3.2	90	5	3.8	1.2	0	-8	0.2	EP**03X1...	0.6
E05G-SEZPR/L03-D065	CARBIDE	6.5	5	3.7	90	6	4.8	1.2	0	-6	0.2	EP**03X1...	0.6

*Torque: Recommended torque (N-m) for clamping ** r_c : Standard corner radius

Note: When using a right or left hand insert, the right hand insert (R) is used for the right hand toolholders (SEZPR ** type), and the left hand insert (L) is used for the left hand toolholders (SEZPL ** type).

SPARE PARTS



Designation	Clamping screw	Wrench
A**-SEZPR/L03-D...	CSTA-1.6	T-6F
E**-SEZPR/L03-D...	CSTA-1.6	T-6F

STREAMJETBAR

A-PCLNR/L

Lever-lock boring bars, for negative 80° rhombic inserts

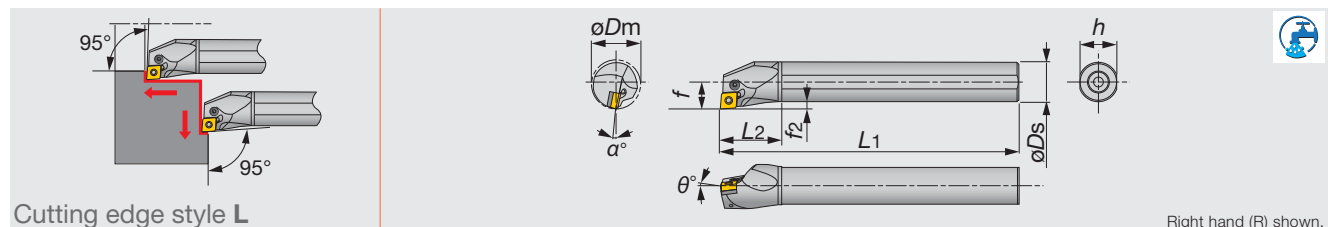

Cutting edge style L

Right hand (R) shown.

Metric	Material	ϕD_m	ϕD_s	f	L_1	L_2	h	f_2	θ°	α°	r_c^{**}	Insert	Torque*
A16M-PCLNR/L09-D200	STEEL	20	16	11	150	32	15	3	-6	-14	0.8	CN**0903...	1.7
A20Q-PCLNR/L09-D250	STEEL	25	20	13	180	36	18	3	-6	-12	0.8	CN**0903...	1.7
A25R-PCLNR/L09-D320	STEEL	32	25	17	200	45	23	4.5	-6	-11	0.8	CN**0903...	1.7
A25R-PCLNR/L12-D320	STEEL	32	25	17	200	45	23	4.5	-6	-13	0.8	CN**1204...	2.7
A32S-PCLNR/L12-D400	STEEL	40	32	22	250	50	30	6	-6	-11	0.8	CN**1204...	4.8
A40T-PCLNR/L12-D500	STEEL	50	40	27	300	60	37	7	-6	-10	0.8	CN**1204...	4.8
A50U-PCLNR/L12-D630	STEEL	63	50	35	350	65	47	10	-6	-8	0.8	CN**1204...	4.8

*Torque: Recommended torque (N-m) for clamping ** r_c : Standard corner radius

Note: When using a right or left hand insert, the right hand insert (R) is used for the left hand toolholders (PCLNL ** type), and the left hand insert (L) is used for the right hand toolholders (PCLNR ** type).

SPARE PARTS



Designation	Shim	Clamping screw 1	Clamping screw 2	Wrench 1	Wrench 2	Spring	Lever	Oil supply attachment (Optional parts)	Screw for oil hole (Optional parts)
A**-PCLNR/L09-D**0	-	LCS22A	-	P-2F	-	-	LCL32N	(EA-25)	(SSHM5-6)
A25R-PCLNR/L12-D320	-	LCS43	-	-	P-2.5	-	LCL43N	(EA-32)	(SSHM5-6)
A32S-PCLNR12-D400	LSC42BR	-	LCS4	-	P-3	LSP4	LCL4	(EA-32)	(SSHM5-6)
A32S-PCLNL12-D400	LSC42BL	-	LCS4	-	P-3	LSP4	LCL4	-	(SSHM5-6)
A40T-PCLNR12-D500	LSC42BR	-	LCS4	-	P-3	LSP4	LCL4	-	(SSHM6-6)
A40T-PCLNL12-D500	LSC42BL	-	LCS4	-	P-3	LSP4	LCL4	-	(SSHM6-6)
A50U-PCLNR12-D630	LSC42BR	-	LCS4	-	P-3	LSP4	LCL4	-	(SSHM6-6)
A50U-PCLNL12-D630	LSC42BL	-	LCS4	-	P-3	LSP4	LCL4	-	(SSHM6-6)

Reference pages

A/E-SEZPR/L: Inserts → **B124 -**, CBN → **B173**

A-PCLNR/L: Inserts → **B052 -**, CBN → **B165 -**, PCD → **B178**

Int. Toolholder

STREAMJETBAR

A-PWLN/L

Lever-lock boring bars, for negative trigon inserts

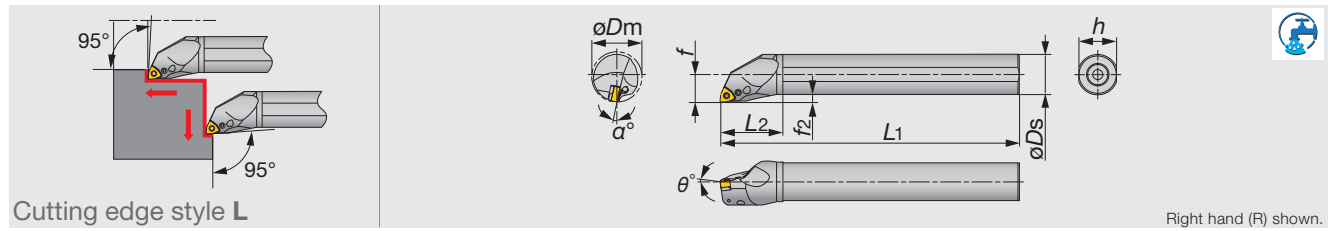

Cutting edge style L

Right hand (R) shown.

Metric	Material	ϕD_m	ϕD_s	f	L_1	L_2	h	f_2	θ°	α°	$r_{e^{**}}$	Insert	Torque*
A16M-PWLN/L06-D200	STEEL	20	16	11	150	32	15	3	-8	-17	0.8	WN**0604...	1.7
A20Q-PWLN/L06-D250	STEEL	25	20	13	180	36	18	3	-6	-14	0.8	WN**0604...	1.7
A25R-PWLN/L06-D320	STEEL	32	25	17	200	45	23	4.5	-6	-12	0.8	WN**0604...	2.7
A32S-PWLN/L06-D400	STEEL	40	32	22	250	50	30	6	-6	-11	0.8	WN**0604...	2.7
A25R-PWLN/L08-D320	STEEL	32	25	17	200	45	23	4.5	-6	-13	0.8	WN**0804...	2.7
A32S-PWLN/L08-D400	STEEL	40	32	22	250	50	30	6	-6	-11	0.8	WN**0804...	4.8
A40T-PWLN/L08-D500	STEEL	50	40	27	300	60	37	7	-6	-10	0.8	WN**0804...	4.8

*Torque: Recommended torque (N-m) for clamping

** r_e : Standard corner radius

SPARE PARTS

Designation	Shim	Clamping screw 1	Clamping screw 2	Wrench 1	Wrench 2	Spring	Lever	Oil supply attachment (Optional parts)	Screw for oil hole (Optional parts)
A16M-PWLN/L06-D200	-	LCS33	-	P-2F	-	-	LCL33N	-	(SSHM3-4)
A20Q-PWLN/L06-D250	-	LCS33	-	P-2F	-	-	LCL33N	(EA-20)	(SSHM3-4)
A25R-PWLN/L06-D320	LSW312BR/L	-	LCS3B	-	P-2.5	LSP3	LCL3	(EA-25)	(SSHM4-5)
A32S-PWLN/L06-D400	LSW312BR/L	-	LCS3	-	P-2.5	LSP3	LCL3	(EA-32)	(SSHM4-5)
A25R-PWLN/L08-D320	-	LCS43	-	-	P-2.5	-	LCL43N	(EA-25)	(SSHM4-5)
A32S-PWLN/L08-D400	LSW42BR/L	-	LCS4	-	P-3	LSP4	LCL4	(EA-32)	(SSHM4-5)
A40T-PWLN/L08-D500	LSW42BR/L	-	LCS4	-	P-3	LSP4	LCL4	-	(SSHM4-5)

STREAMJETBAR

A-PSKNR/L

Lever-lock boring bars, for negative square inserts

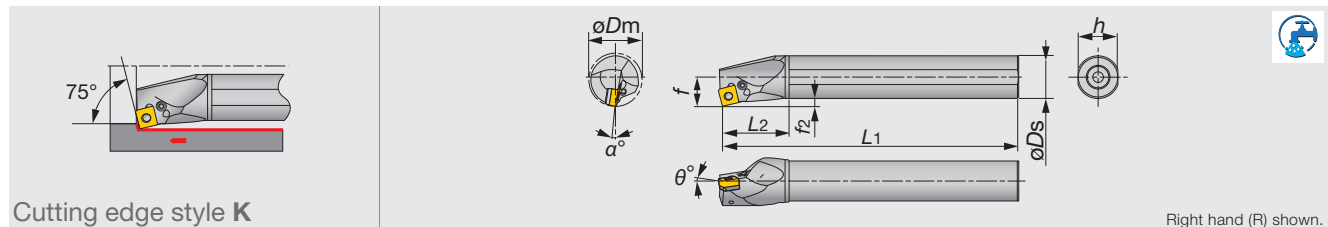

Cutting edge style K

Right hand (R) shown.

Metric	Material	ϕD_m	ϕD_s	f	L_1	L_2	h	f_2	θ°	α°	$r_{e^{**}}$	Insert	Torque*
A32S-PSKNR/L12-D400	STEEL	40	32	22	250	50	30	6	-6	-10	0.8	SN**1204...	4.8
A40T-PSKNR/L12-D500	STEEL	50	40	27	300	60	37	7	-6	-10	0.8	SN**1204...	4.8
A50U-PSKNR/L12-D630	STEEL	63	50	35	350	65	47	10	-6	-8	0.8	SN**1204...	4.8

*Torque: Recommended torque (N-m) for clamping ** r_e : Standard corner radius

Note: When using a right or left hand insert, the right hand insert (R) is used for the left hand toolholders (PSKNL ** type), and the left hand insert (L) is used for the right hand toolholders (PSKNR ** type).

SPARE PARTS

Designation	Shim	Clamping screw	Wrench	Spring	Lever	Oil supply attachment (Optional parts)	Screw for oil hole (Optional parts)
A32S-PSKNR/L12-D400	LSS42BR/L	LCS4	P-3	LSP4	LCL4	(EA-32)	(SSHM4-5)
A40T-PSKNR/L12-D500	LSS42BR/L	LCS4	P-3	LSP4	LCL4	-	(SSHM6-6)
A50U-PSKNR/L12-D630	LSS42BR/L	LCS4	P-3	LSP4	LCL4	-	(SSHM6-6)

Reference pages

A-PWLN/L: Inserts → B097 -, CBN → B167

A-PSKNR/L: Inserts → B073 -, CBN → B166 -, PCD → B178

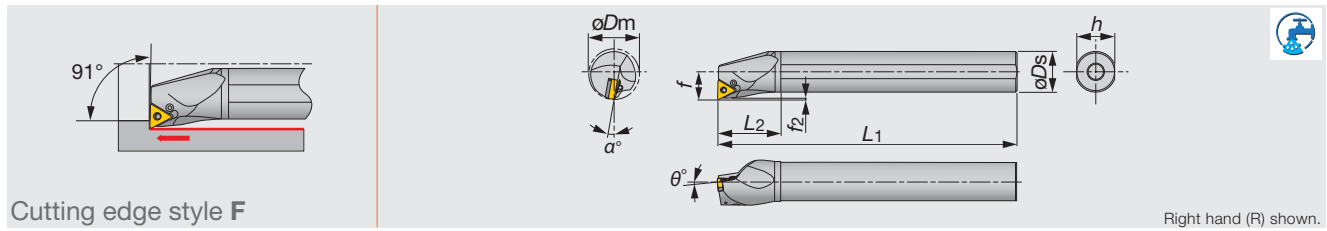

Cutting edge style F

Right hand (R) shown.

Metric	Material	ϕD_m	ϕD_s	f	L_1	L_2	h	f_2	θ°	α°	r_e^{**}	Insert	Torque*
A25R-PTFNR/L16-D320	STEEL	32	25	17	200	45	23	1.2	-6	-12	0.8	TN**1604...	2.7
A32S-PTFNR/L16-D400	STEEL	40	32	22	250	50	30	1.1	-6	-10	0.8	TN**1604...	2.7
A40T-PTFNR/L16-D500	STEEL	50	40	27	300	60	37	1.1	-6	-10	0.8	TN**1604...	2.7
A50U-PTFNR/L16-D630	STEEL	63	50	35	350	65	47	1.1	-6	-8	0.8	TN**1604...	2.7

*Torque: Recommended torque (N-m) for clamping ** r_e : Standard corner radius

Note: When using a right or left hand insert, the right hand insert (R) is used for the left hand toolholders (PTFNL ** type), and the left hand insert (L) is used for the right hand toolholders (PTFNR ** type).

SPARE PARTS

Designation	Shim	Clamping screw	Wrench	Spring	Lever	Oil supply attachment (Optional parts)	Screw for oil hole (Optional parts)
A25R-PTFNR/L16-D320	ELST317BR/L	LCS3	P-2.5	LSP3	LCL33	(EA-25)	(SSHM4-5)
A32S-PTFNR/L16-D400	LST317BR/L	LCS3	P-2.5	LSP3	LCL3	(EA-32)	(SSHM4-5)
A40T-PTFNR/L16-D500	LST317BR/L	LCS3	P-2.5	LSP3	LCL3	-	(SSHM6-6)
A50U-PTFNR/L16-D630	LST317BR/L	LCS3	P-2.5	LSP3	LCL3	-	(SSHM6-6)

Int. Toolholder

Reference pages

A-PTFNR/L: Inserts → **B082** -, CBN → **B166** -, PCD → **B178**

STREAMJETBAR

A-PDUNR/L

Lever-lock boring bars, for negative 55° rhombic inserts

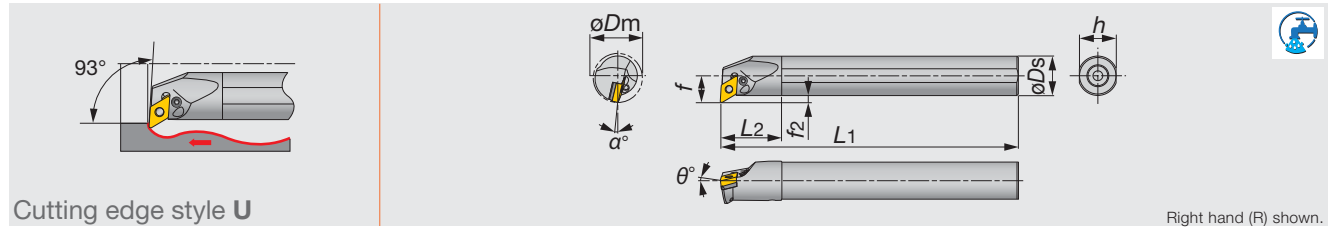

Metric	Material	ϕD_m	ϕD_s	f	L1	L2	h	f2	θ°	α°	r ϵ^{**}	Insert	Torque*
A20Q-PDUNR/L11-D250	STEEL	25	20	13	180	36	18	3	-6	-14	0.8	DN**1104...	1.7
A25R-PDUNR/L11-D320	STEEL	32	25	17	200	45	23	4.5	-6	-12	0.8	DN**1104...	2.7
A32S-PDUNR/L15-D400	STEEL	40	32	22	250	50	30	6	-6	-13	0.8	DN**1504...	4.8
A40T-PDUNR/L15-D500	STEEL	50	40	27	300	60	37	7	-6	-10	0.8	DN**1504...	4.8
A50U-PDUNR/L15-D630	STEEL	63	50	35	350	65	47	10	-6	-8	0.8	DN**1504...	4.8
A32S-PDUNR/L1506-D400	STEEL	40	32	22	250	50	30	6	-6	-13	0.8	DN**1506...	4.8
A40T-PDUNR/L1506-D500	STEEL	50	40	27	300	60	37	7	-6	-11	0.8	DN**1506...	4.8
A50U-PDUNR/L1506-D630	STEEL	63	50	35	350	65	47	10	-6	-10	0.8	DN**1506...	4.8

*Torque: Recommended torque (N-m) for clamping

**r ϵ : Standard corner radius

SPARE PARTS

Designation	Shim	Clamping screw 1	Clamping screw 2	Wrench 1	Wrench 2	Spring	Lever	Oil supply attachment (Optional parts)	Screw for oil hole (Optional parts)
A20Q-PDUNR/L11-D250	-	LCS22A	-	P-2F	-	-	LCL33NL	(EA-20)	(SSH2.5-3)
A25R-PDUNR/L11-D320	ELSD317BR/L	-	LCS3	-	P-2.5	LSP3	LCL33L	(EA-25)	(SSH3-4)
A32S-PDUNR/L15-D400	LSD42BR/L	-	LCS4	-	P-3	LSP4	LCL4	(EA-32)	(SSH5-6)
A40T-PDUNR/L15-D500	LSD42BR/L	-	LCS4	-	P-3	LSP4	LCL4	-	(SSH6-6)
A50U-PDUNR/L15-D630	LSD42BR/L	-	LCS4	-	P-3	LSP4	LCL4	-	(SSH6-6)
A32S-PDUNR/L1506-D400	ELSD42	-	ELCS4	-	P-3	LSP4S	LCL44	(EA-20)	(SSH5-6)
A40T-PDUNR/L1506-D500	ELSD42	-	ELCS4	-	P-3	LSP4S	LCL44	-	(SSH6-6)
A50U-PDUNR/L1506-D630	ELSD42	-	ELCS4	-	P-3	LSP4S	LCL44	-	(SSH6-6)

STREAMJETBAR

A-PTUNR/L

Lever-lock boring bars, for negative triangle inserts

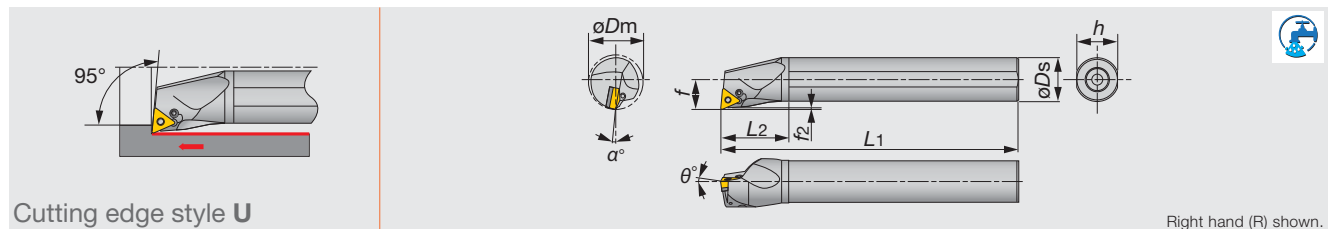

Metric	Material	ϕD_m	ϕD_s	f	L1	L2	h	f2	θ°	α°	r ϵ^{**}	Insert	Torque*
A16M-PTUNR/L11-D200	STEEL	20	16	11	150	32	15	1	-6	-14	0.4	TN**1103...	1.7
A20Q-PTUNR/L11-D250	STEEL	25	20	13	180	36	18	1	-6	-12	0.4	TN**1103...	1.7
A25R-PTUNR/L16-D320	STEEL	32	25	17	200	45	23	1.4	-6	-12	0.8	TN**1604...	2.7
A32S-PTUNR/L16-D400	STEEL	40	32	22	250	50	30	1.3	-6	-10	0.8	TN**1604...	2.7

*Torque: Recommended torque (N-m) for clamping **r ϵ : Standard corner radius

Note: The insert hole conforms to the ISO standard.

Tool holder length may be different to the ISO standard.

When using a right or left hand insert, the right hand insert (R) is used for the left hand toolholders (PTUNL ** type), and the left hand insert (L) is used for the right hand toolholders (PTUNR ** type).

SPARE PARTS

Designation	Shim	Clamping screw1	Clamping screw2	Wrench 1	Wrench 2	Spring	Lever	Oil supply attachment (Optional parts)	Screw for oil hole (Optional parts)
A16M-PTUNR/L11-D200	-	LCS22A	-	P-2F	-	-	LCL22N	-	(SSH3-4)
A20Q-PTUNR/L11-D250	-	LCS22A	-	P-2F	-	-	LCL22N	(EA-20)	(SSH3-4)
A25R-PTUNR/L16-D320	ELST317BR/L	-	LCS3	-	P-2.5	LSP3	LCL33	(EA-25)	(SSH4-5)
A32S-PTUNR/L16-D400	LST317BR/L	-	LCS3	-	P-2.5	LSP3	LCL3	(EA-32)	(SSH4-5)

STREAMJETBAR

A-PVUNR/L

Lever-lock boring bars, for negative 35° rhombic inserts

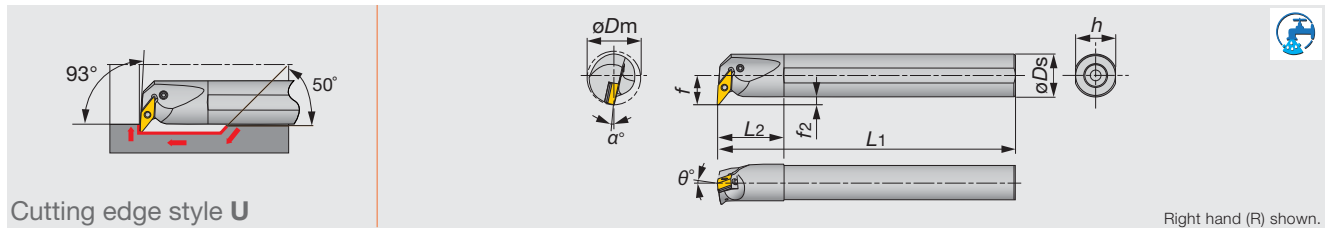

Cutting edge style U

Right hand (R) shown.

Metric	Material	ϕD_m	ϕD_s	f	L_1	L_2	h	f_2	θ°	α°	r_e^{**}	Insert	Torque*
A25R-PVUNR/L16-D370	STEEL	37	25	22	200	45	23	9.5	-5	-14	0.8	V/YN**1604...	2.7
A32S-PVUNR/L16-D400	STEEL	40	32	22	250	50	30	6	-5	-12	0.8	V/YN**1604...	2.7
A40T-PVUNR/L16-D500	STEEL	50	40	27	300	60	37	7	-5	-10	0.8	V/YN**1604...	2.7

*Torque: Recommended torque (N-m) for clamping

** r_e : Standard corner radius

SPARE PARTS

Designation	Shim	Clamping screw	Wrench	Spring	Lever	Oil supply attachment (Optional parts)	Screw for oil hole (Optional parts)
A25R-PVUNR/L16-D370	LSV317BR/L	LCS3V	P-2.5	LSP3	LCL3V	(EA-25)	(SSH4-5)
A32S-PVUNR/L16-D400	LSV317BR/L	LCS3V	P-2.5	LSP3	LCL3V	(EA-32)	(SSH4-5)
A40T-PVUNR/L16-D500	LSV317BR/L	LCS3V	P-2.5	LSP3	LCL3V	-	(SSH5-6)

STREAMJETBAR

A-PDZNR/L

Lever-lock boring bars, for negative 55° rhombic inserts

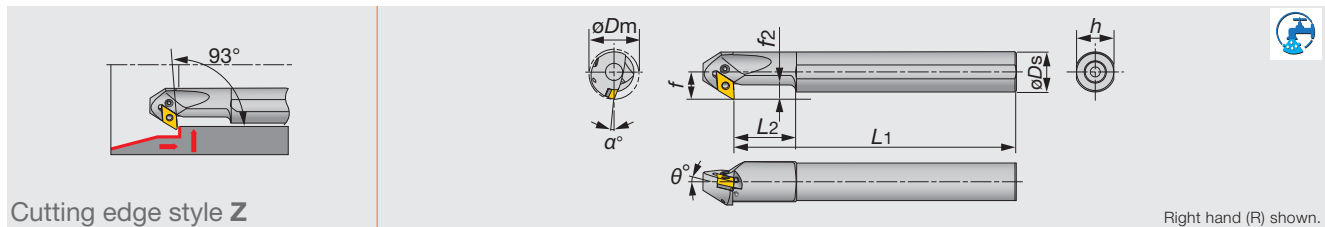

Cutting edge style Z

Right hand (R) shown.

Metric	Material	ϕD_m	ϕD_s	f	L_1	L_2	h	f_2	θ°	α°	r_e^{**}	Insert	Torque*
A32S-PDZNR/L15-D400	STEEL	40	32	22	250	50	30	11.5	-6	-13	0.8	DN**1504...	4.8
A40T-PDZNR/L15-D500	STEEL	50	40	27	300	60	37	14.5	-6	-10	0.8	DN**1504...	4.8
A50U-PDZNR/L15-D630	STEEL	63	50	35	350	65	47	14.5	-6	-8	0.8	DN**1504...	4.8

*Torque: Recommended torque (N-m) for clamping ** r_e : Standard corner radius

Note: When using a right or left hand insert, the right hand insert (R) is used for the right hand toolholders (PDZNR** type), and the left hand insert (L) is used for the left hand toolholders (PDZNL** type).

SPARE PARTS

Designation	Shim	Clamping screw	Wrench	Spring	Lever	Oil supply attachment (Optional parts)	Screw for oil hole (Optional parts)
A32S-PDZNR15-D400	LSZ42BR	LCS4	P-3	LSP4	LCL4	(EA-32)	(SSH4-5)
A32S-PDZNL15-D400	LSZ42BL	LCS4	P-3	LSP4	LCL4	(EA-32)	(SSH4-5)
A40T-PDZNR15-D500	LSZ42BR	LCS4	P-3	LSP4	LCL4	-	(SSH5-6)
A40T-PDZNL15-D500	LSZ42BL	LCS4	P-3	LSP4	LCL4	-	(SSH5-6)
A50U-PDZNR15-D630	LSZ42BR	LCS4	P-3	LSP4	LCL4	-	(SSH6-6)
A50U-PDZNL15-D630	LSZ42BL	LCS4	P-3	LSP4	LCL4	-	(SSH6-6)

Reference pages

A-PDUNR/L: Inserts → B063 -, CBN → B165 -, PCD → B178

A-PTUNR/L: Inserts → B082 -, CBN → B166 -, PCD → B178

A-PVUNR/L: Inserts → B093 -, B104, CBN → B167 -, PCD → B178

A-PDZNR/L: Inserts → B063 -, CBN → B165 -, PCD → B178

Int. Toolholder

TURNINGA

A-ACLNR/L

Double-clamp boring bar, for negative 80° rhombic inserts

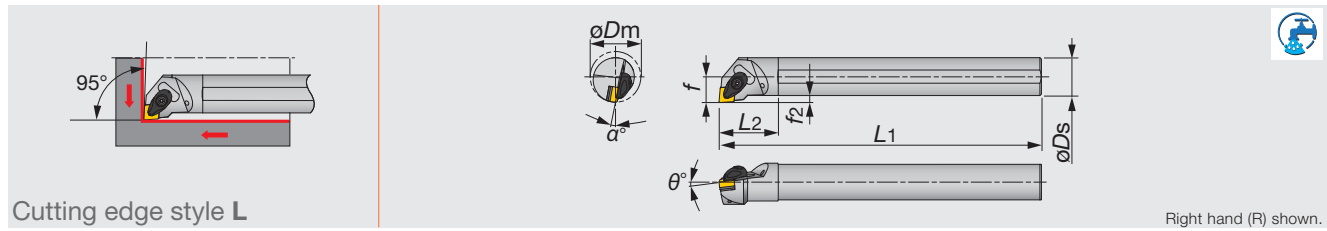

Cutting edge style L

Right hand (R) shown.

Inch	Material	ϕD_m	ϕD_s	f	L1	L2	h	f2	θ°	α°	re**	Insert	Torque*
A16-ACLNR/L4-D20	STEEL	1.250	1.000	0.640	12.000	1.750	0.906	0.177	-6	-13	0.031	CN**43...	2.21
A20-ACLNR/L4-D25	STEEL	1.560	1.250	0.770	14.000	1.930	1.180	0.236	-6	-10	0.031	CN**43...	2.21
A24-ACLNR/L4-D32	STEEL	2.000	1.500	0.890	14.000	2.160	1.450	0.275	-6	-8	0.031	CN**43...	2.21
A32-ACLNR/L4-D40	STEEL	2.500	2.000	1.280	16.000	2.550	1.850	0.393	-6	-7	0.031	CN**43...	2.21

*NOTE: Dimension (h) is the distance between flats on the shank

*Torque: Recommended torque (lb-ft) for clamping

**re: Standard corner radius

SPARE PARTS

Designation	Clamp	Clamp screw	Spring	Spring pin	Shim	Shim screw	Wrench
A**-ACLNR/L4-D...	ACP4S	ACS-5W	BP-7	SP-2.5	ASC422	CSTB-3.5	T-15F

TURNINGA

A-AWLNR/L

Double-clamp boring bar, for negative trigon inserts

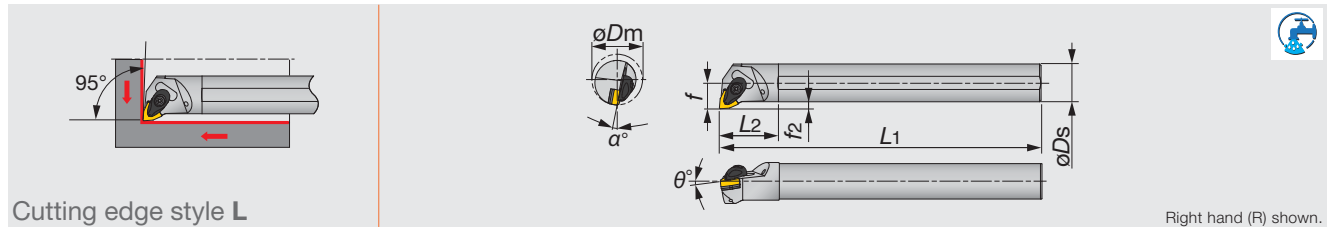

Cutting edge style L

Right hand (R) shown.

Inch	Material	ϕD_m	ϕD_s	f	L1	L2	h	f2	θ°	α°	re**	Insert	Torque*
A16-AWLNR/L3-D20	STEEL	1.250	1.000	0.672	12.000	1.770	0.906	0.177	-6	-13	0.031	WN**33...	2.21
A20-AWLNR/L3-D25	STEEL	1.560	1.250	0.859	14.000	1.960	1.180	0.236	-6	-10	0.031	WN**33...	2.21
A16-AWLNR/L4-D20	STEEL	1.250	1.000	0.672	12.000	1.770	0.906	0.177	-6	-13	0.031	WN**43...	2.21
A20-AWLNR/L4-D25	STEEL	1.560	1.250	0.859	14.000	1.960	1.180	0.236	-6	-10	0.031	WN**43...	2.21
A24-AWLNR/L4-D32	STEEL	2.000	1.500	1.060	14.000	2.160	1.460	0.275	-6	-8	0.031	WN**43...	2.21
A32-AWLNR/L4-D40	STEEL	2.500	2.000	1.370	16.000	2.550	1.850	0.393	-6	-7	0.031	WN**43...	2.21

*Torque: Recommended torque (lb-ft) for clamping

**re: Standard corner radius

SPARE PARTS

Designation	Clamp	Clamp screw	Spring	Spring pin	Shim	Shim screw	Wrench
A**-AWLNR/L3-D...	ACP3S	ACS-5W	BP-7	SP-2.5	ASW322	CSTB-3.5	T-15F
A**-AWLNR/L4-D...	ACP4S	ACS-5W	BP-7	SP-2.5	ASW422	CSTB-3.5	T-15F

Reference pages

A-ACLNR/L: Inserts → **B052** -, CBN → **B165** -, PCD → **B178**

A-AWLNR/L: Inserts → **B097** -, CBN → **B167**

TURNINGA

A-ASKNR/L

Double-clamp boring bar, for negative square inserts

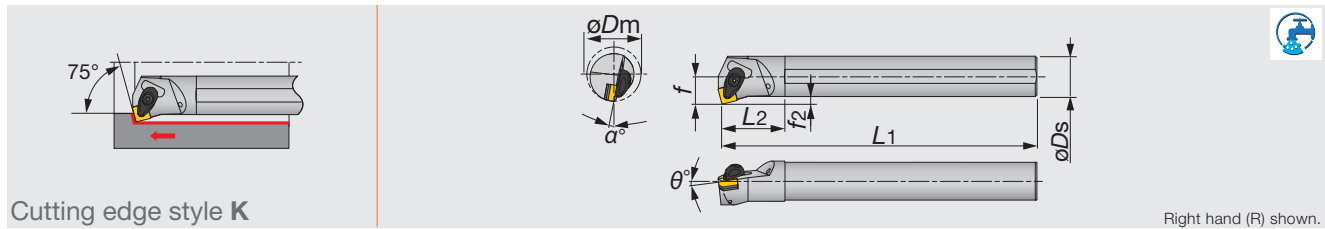

Cutting edge style K

Right hand (R) shown.

Inch	Material	ϕD_m	ϕD_s	f	L_1	L_2	h	f_2	θ°	α°	$r_{e^{**}}$	Insert	Torque*
A16-ASKNR/L4-D20	STEEL	1.250	1.000	0.672	12.000	1.770	0.906	0.177	-6	-13	0.031	SN**43...	2.21
A20-ASKNR/L4-D25	STEEL	1.500	1.250	0.859	14.000	1.960	1.180	0.236	-6	-10	0.031	SN**43...	2.21

*Torque: Recommended torque (lbf-ft) for clamping

**re: Standard corner radius

SPARE PARTS

Designation	Clamp	Clamp screw	Spring	Spring pin	Shim	Shim screw	Wrench
A**-ASKNR/L4-D...	ACP4S	ACS-5W	BP-7	SP-2.5	ASS422	CSTB-3.5	T-15F

Int. Toolholder

TURNINGA

A-ATFNR/L

Double-clamp boring bar, for negative triangle inserts

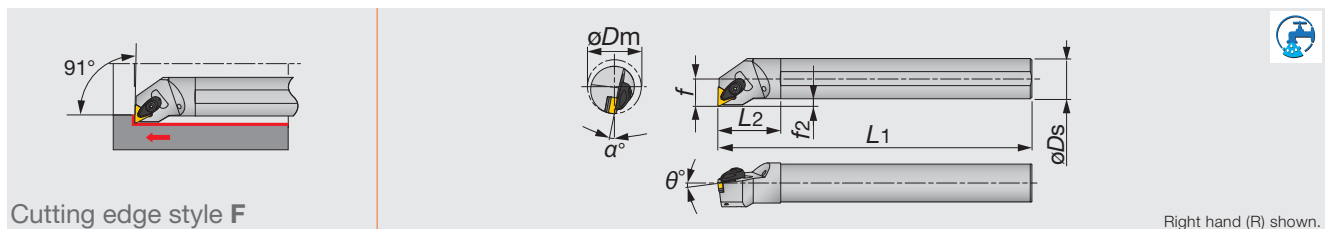

Cutting edge style F

Right hand (R) shown.

Inch	Material	ϕD_m	ϕD_s	f	L_1	L_2	h	f_2	θ°	α°	$r_{e^{**}}$	Insert	Torque*
A16-ATFNR/L3-D20	STEEL	1.250	1.000	0.672	12.000	1.770	0.906	0.177	-6	-13	0.031	TN**33...	2.21
A20-ATFNR/L3-D25	STEEL	1.560	1.250	0.859	14.000	1.960	1.180	0.236	-6	-10	0.031	TN**33...	2.21

*Torque: Recommended torque (lbf-ft) for clamping

**re: Standard corner radius

SPARE PARTS

Designation	Clamp	Clamp screw	Spring	Spring pin	Shim	Shim screw	Wrench
A**-ATFNR/L3-D...	ACP3S	ACS-5W	BP-7	SP-2.5	AST322	CSTB-3.5	T-15F

Reference pages

A-ASKNR/L: Inserts → **B073** -, CBN → **B166** -, PCD → **B178**

A-ATFNR/L: Inserts → **B082** -, CBN → **B166** -, PCD → **B178**

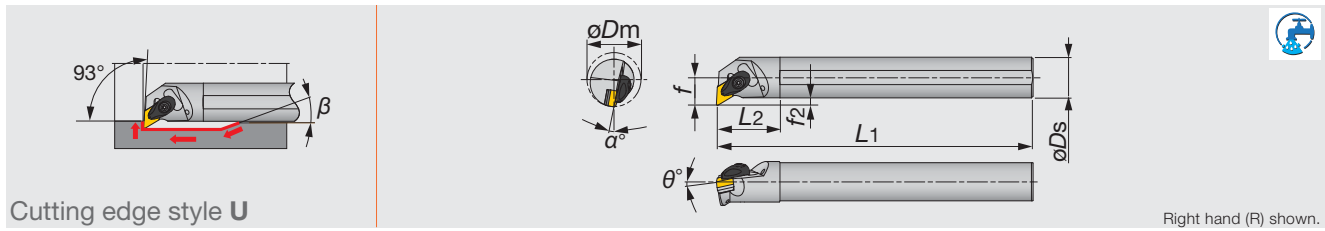

Cutting edge style U

Right hand (R) shown.

Inch	Material	ϕD_m	ϕD_s	f	L_1	L_2	h	f_2	θ°	α°	β	r_{ϵ}^{**}	Insert	Torque*
A16-ADUNR/L4-D20	STEEL	1.250	1.000	0.672	12.000	1.770	0.906	0.177	-6	-13	30	0.031	DN**43...	2.21
A20-ADUNR/L4-D25	STEEL	1.500	1.250	0.859	14.000	1.960	1.180	0.236	-6	-11	20	0.031	DN**43...	2.21
A24-ADUNR/L4-D32	STEEL	2.000	1.500	1.063	14.000	2.160	1.450	0.275	-6	-8	15	0.031	DN**43...	2.21

*Torque: Recommended torque (lbf-ft) for clamping

** r_{ϵ} : Standard corner radius

SPARE PARTS

Designation	Clamp	Clamp screw	Spring	Spring pin	Shim	Shim screw	Wrench
A**-ADUNR/L4-D...	ACP4S	ACS-5W	BP-7	SP-2.5	ASD432	CSTB-3.5	T-15F

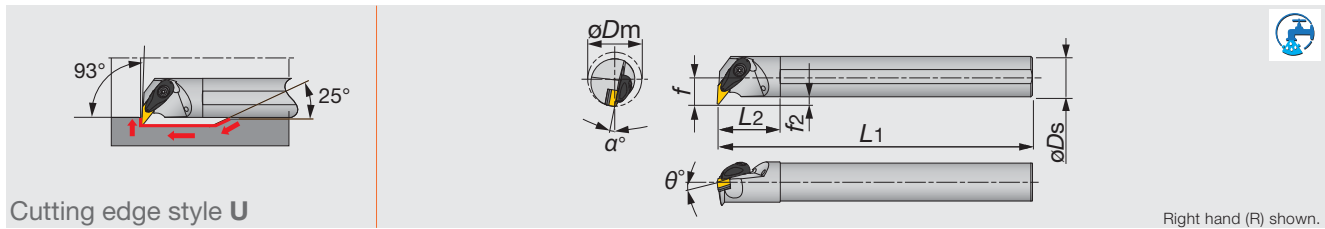

Cutting edge style U

Right hand (R) shown.

Inch	Material	ϕD_m	ϕD_s	f	L_1	L_2	h	f_2	θ°	α°	r_{ϵ}^{**}	Insert	Torque*
A20-AVUNR/L3-D25	STEEL	1.560	1.250	0.859	14.000	1.960	1.180	0.236	-6	-10	0.031	V/YN**33...	2.21
A24-AVUNR/L3-D32	STEEL	2.000	1.500	1.060	14.000	2.160	1.440	0.275	-6	-8	0.031	V/YN**33...	2.21

*Torque: Recommended torque (lbf-ft) for clamping

** r_{ϵ} : Standard corner radius

SPARE PARTS

Designation	Clamp	Clamp screw	Spring	Spring pin	Shim	Shim screw	Wrench
A**-AVUNR/L3-D...	ACP3L	ACS-5W	BP-7	SP-2.5	ASV322	CSTB-3.5	T-15F

Reference pages

A-ADUNR/L: Inserts → B063 -, CBN → B165 -, PCD → B178

A-AVUNR/L: Inserts → B093 -, B104, CBN → B167 -, PCD → B178

Y-PRO SERIES

A/E-SYUBR/L

Screw-on boring bars, for positive 25° rhombic inserts

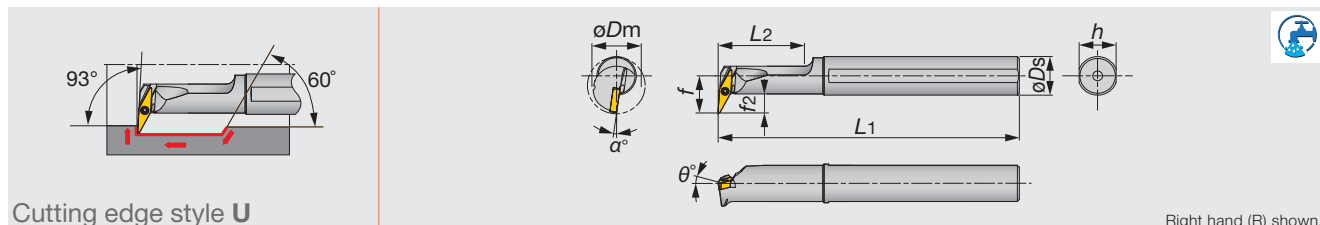

Cutting edge style U

Right hand (R) shown.

Inch	Material	ϕD_m	ϕD_s	f	L_1	L_2	h	f_2	θ°	α°	r_{ϵ}^{**}	Insert	Torque*
A10-SYUBR/L2-D16	STEEL	1.000	0.625	0.625	7.000	1.250	0.600	0.312	0	-8	0.016	YW**11T2...	0.44
E08-SYUBR/L2-D14	CARBIDE	0.875	0.500	0.563	5.000	1.060	0.475	0.307	0	-8	0.016	YW**11T2...	0.44
E10-SYUBR/L2-D16	CARBIDE	1.000	0.625	0.625	7.000	1.250	0.600	0.307	0	-8	0.016	YW**11T2...	0.44
Metric	Material	ϕD_m	ϕD_s	f	L_1	L_2	h	f_2	θ°	α°	r_{ϵ}^{**}	Insert	Torque*
A16Q-SYUBR/L11-D200	STEEL	20	16	15.5	180	35	15	8	0	-8	0.4	YW**11T2...	0.6
E12Q-SYUBR/L11-D200	CARBIDE	20	12	13.5	180	27	11	7.5	0	-8	0.4	YW**11T2...	0.6
E16R-SYUBR/L11-D245	CARBIDE	24.5	16	16	200	32	15	8	0	-8	0.4	YW**11T2...	0.6

*Torque: Recommended torque (lbf-ft,N-m) for clamping

** r_{ϵ} : Standard corner radius

SPARE PARTS

Designation	Clamping screw	Wrench
A10-SYUBR/L2-D16	CSTB-2L	T-6F
E**-SYUBR/L2-D...	CSTB-2L	T-6F
A16Q-SYUBR/L11-D200	CSTB-2L	T-6F
E**-SYUBR/L11-D...	CSTB-2L	T-6F

Y-PRO SERIES

A/E-SYQBR/L

Screw-on boring bars, for positive 25° rhombic inserts

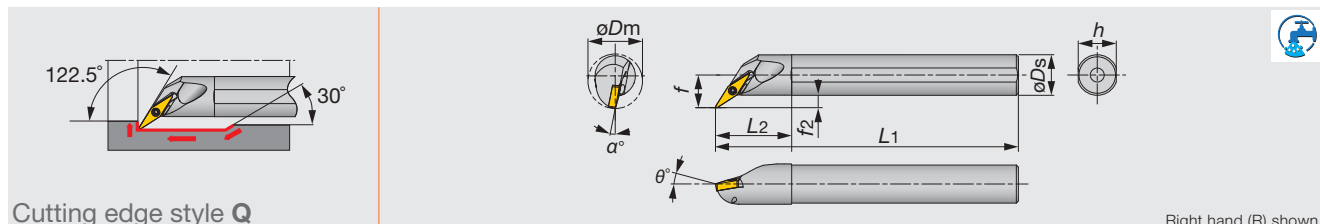

Cutting edge style Q

Right hand (R) shown.

Inch	Material	ϕD_m	ϕD_s	f	L_1	L_2	h	f_2	θ°	α°	r_{ϵ}^{**}	Insert	Torque*
A08-SYQBR/L2-D12	STEEL	0.750	0.500	0.438	5.000	1.000	0.475	0.188	0	-10	0.016	YW**11T2...	0.44
A10-SYQBR/L2-D14	STEEL	0.875	0.625	0.500	7.000	1.250	0.600	0.188	0	-8	0.016	YW**11T2...	0.44
E08-SYQBR/L2-D12	CARBIDE	0.750	0.500	0.438	5.000	1.000	0.475	0.188	0	-10	0.016	YW**11T2...	0.44
E10-SYQBR/L2-D14	CARBIDE	0.875	0.625	0.500	7.000	1.250	0.600	0.188	0	-8	0.016	YW**11T2...	0.44
Metric	Material	ϕD_m	ϕD_s	f	L_1	L_2	h	f_2	θ°	α°	r_{ϵ}^{**}	Insert	Torque*
A12M-SYQBR/L11-D170	STEEL	17	12	10.5	150	24	11	4.5	-5	-10	0.4	YW**11T2...	0.6
A16Q-SYQBR/L11-D215	STEEL	21.5	16	13	180	30	15	5	-5	-8	0.4	YW**11T2...	0.6
E12Q-SYQBR/L11-D170	CARBIDE	17	12	10.5	180	27	11	4.5	-5	-10	0.4	YW**11T2...	0.6
E16R-SYQBR/L11-D215	CARBIDE	21.5	16	13	200	32	15	5	-5	-8	0.4	YW**11T2...	0.6

*Torque: Recommended torque (lbf-ft,N-m) for clamping

** r_{ϵ} : Standard corner radius

SPARE PARTS

Designation	Clamping screw	Wrench
A**-SYQBR/L2-D...	CSTB-2L	T-6F
E**-SYQBR/L2-D...	CSTB-2L	T-6F
A**-SYQBR/L11-D...	CSTB-2L	T-6F
E**-SYQBR/L11-D...	CSTB-2L	T-6F

Reference pages

A/E-SYUBR/L, A/E-SYQBR/L: Inserts → **B155**

Int. Toolholder

T-SCLCR/L

Tsuppari-Ichiban, Screw-on boring bar, for positive 80° rhombic inserts

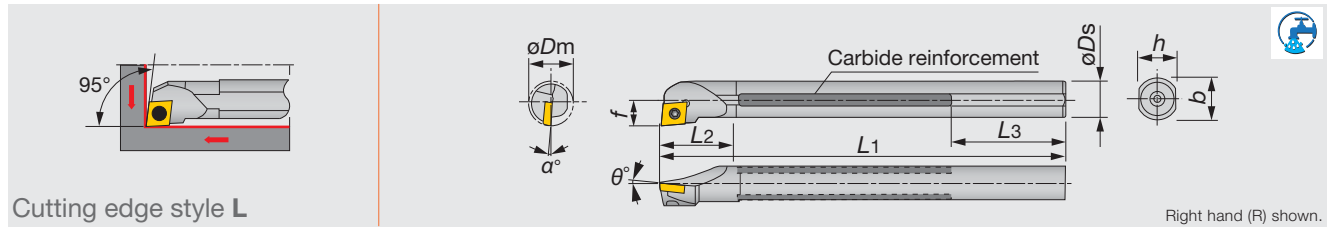

Metric	Material	αD_m	Oil hole	αD_s	f	L_1	L_2	L_3	h	b	α°	θ°	r_{ϵ}^{**}	Insert	Torque*
T12M-SCLCR/L06	TSUPPARI	16	-	12	9	150	22	59	11	-	-10	0	0.4	CC**0602...	1.2
T16Q-SCLCR/L09	TSUPPARI	20	-	16	11	180	27	59	15	-	-10	0	0.8	CC**09T3...	3
T20R-SCLCR/L09C	TSUPPARI	25	Rc1/4	20	13	200	35	49	18	-	-8	0	0.8	CC**09T3...	3
T25S-SCLCR/L09C	TSUPPARI	32	Rc1/4	25	17	250	40	64	23	-	-6	0	0.8	CC**09T3...	3

*Torque: Recommended torque (N-m) for clamping ** r_{ϵ} : Standard corner radius

Note: The hole of inserts conforms to ISO standard.

When using a right or left hand insert, the right hand insert (R) is used for the left hand toolholders (SCLCL** type), and the left hand insert (L) is used for the right hand toolholders (SCLCR** type).

SPARE PARTS

Designation	Clamping screw	Wrench
T12M-SCLCR/L06	CSTB-2.5	T-8F
T16Q-SCLCR/L09	CSTB-4S	T-15F
T20R-SCLCR/L09C	CSTB-4S	T-15F
T25S-SCLCR/L09C	CSTB-4S	T-15F

T-SCLPR/L

Tsuppari-Ichiban, Screw-on boring bar, for positive 80° rhombic inserts

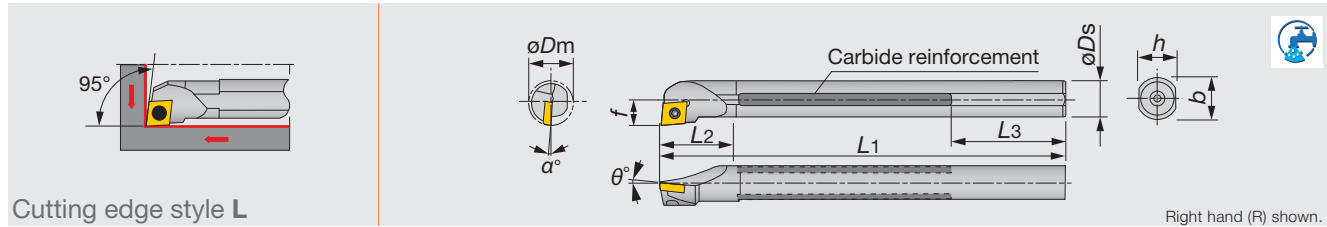

Metric	Material	αD_m	Oil hole	αD_s	f	L_1	L_2	L_3	h	α°	θ°	r_{ϵ}^{**}	Insert	Torque*
T12M-SCLPR08-D14	TSUPPARI	14	-	12	7	150	22	59	11	-4	5	0.4	CP**0802...	1.4
T12M-SCLPR/L08	TSUPPARI	16	-	12	9	150	25	59	11	-3	5	0.4	CP**0802...	1.4
T16Q-SCLPR09-D18	TSUPPARI	18	-	16	9	180	27	59	15	-3.5	5	0.8	CP**0903...	3
T16Q-SCLPR/L09	TSUPPARI	20	-	16	11	180	30	59	15	-4	5	0.8	CP**0903...	3
T20R-SCLPR09C-D22	TSUPPARI	22	Rc1/4	20	11	200	35	49	18	-2	5	0.8	CP**0903...	3
T20R-SCLPR/L09	TSUPPARI	25	-	20	13	200	35	49	18	-2	5	0.8	CP**0903...	3
T25S-SCLPR09C-D27	TSUPPARI	27	Rc1/4	25	13.5	250	40	64	23	-1	5	0.8	CP**0903...	3
T25S-SCLPR/L09	TSUPPARI	32	-	25	17	250	40	64	23	0	5	0.8	CP**0903...	3

*Torque: Recommended torque (N-m) for clamping ** r_{ϵ} : Standard corner radius

Note: When using a right or left hand insert, the right hand insert (R) is used for the left hand toolholders (SCLPL** type), and the left hand insert (L) is used for the right hand toolholders (SCLPR** type).

SPARE PARTS

Designation	Clamping screw	Wrench
T12M-SCLPR/L08...	CSTB-3L050	T-9F
T16Q-SCLPR09-D18	CSTB-4L060	T-15F
T16Q-SCLPR/L09	CSTB-4S	T-15F
T20R-SCLPR09C-D22	CSTB-4L060	T-15F
T20R-SCLPR/L09	CSTB-4S	T-15F
T25S-SCLPR09C-D27	CSTB-4L060	T-15F
T25S-SCLPR/L09	CSTB-4S	T-15F

Reference pages

T-SCLCR/L: Inserts → **B106** -, CBN → **B170** -, PCD → **B179**

T-SCLPR/L: Inserts → **B113** -

T-STUPR/L

Tsuppari-Ichiban boring bar, for positive triangle inserts

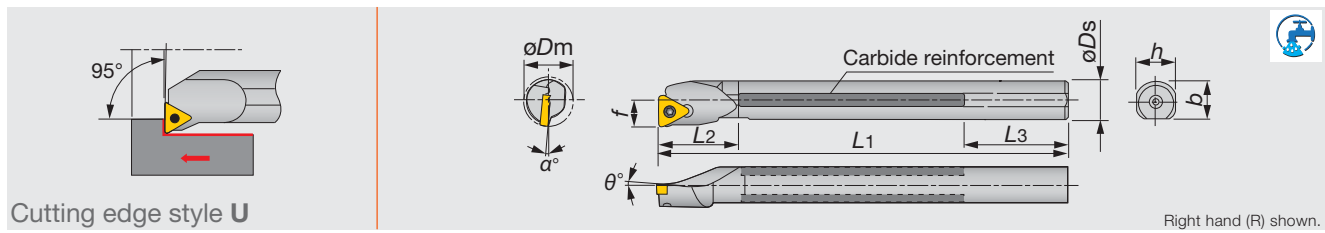

Cutting edge style U

Right hand (R) shown.

Metric	Material	$\varnothing D_m$	Oil hole	$\varnothing D_s$	f	L_1	L_2	L_3	h	θ°	α°	r_{ϵ}^{**}	Insert	Torque*
T12M-STUPR11-D14	TSUPPARI	14	-	12	7	150	24	59	11	5	-4	0.4	TP**1102...	1.2
T12M-STUPR/L11	TSUPPARI	16	-	12	9	150	25	58	11	5	-4	0.4	TP**1102...	1.2
T16Q-STUPR13-D18	TSUPPARI	18	-	16	9	180	30	59	15	5	-3.5	0.4	TP**1303...	1.4
T16Q-STUPR/L13	TSUPPARI	20	-	16	11	180	30	59	15	5	-3	0.4	TP**1303...	1.4
T20R-STUPR13C-D22	TSUPPARI	22	Rc1/4	20	11	200	35	49	18	5	-2	0.4	TP**1303...	1.4
T20R-STUPR/L13	TSUPPARI	24	-	20	13	200	40	49	18	5	-2	0.4	TP**1303...	1.4
T25S-STUPR16C-D27	TSUPPARI	27	Rc1/4	25	13.5	250	40	64	23	5	-1	0.8	TP**16T3...	3
T25S-STUPR/L16	TSUPPARI	31	-	25	17	250	45	64	23	5	0	0.8	TP**16T3...	3

*Torque: Recommended torque (N·m) for clamping ** r_{ϵ} : Standard corner radius

Note: When using a right or left hand insert, the right hand insert (R) is used for the left hand toolholders (STUPL** type), and the left hand insert (L) is used for the right hand toolholders (STUPR** type).

SPARE PARTS



Designation	Clamping screw	Wrench
T12M-STUPR11-D14	CSTB-2.5B	T-8F
T12M-STUPR/L11	CSTB-2.5	T-8F
T16Q-STUPR13-D18	CSTB-3S	T-9F
T16Q-STUPR/L13	CSTB-3	T-9F
T20R-STUPR13C-D22	CSTB-3S	T-9F
T20R-STUPR/L13	CSTB-3	T-9F
T25S-STUPR/L16...	CSTB-4S	T-15F

Reference pages

T-STUPR/L: Inserts → B138 -, CBN → B170 -, PCD → B180



Int. Toolholder

T-SVUBR

Tsuppari-Ichiban, Screw-on boring bar, for positive 35° rhombic inserts

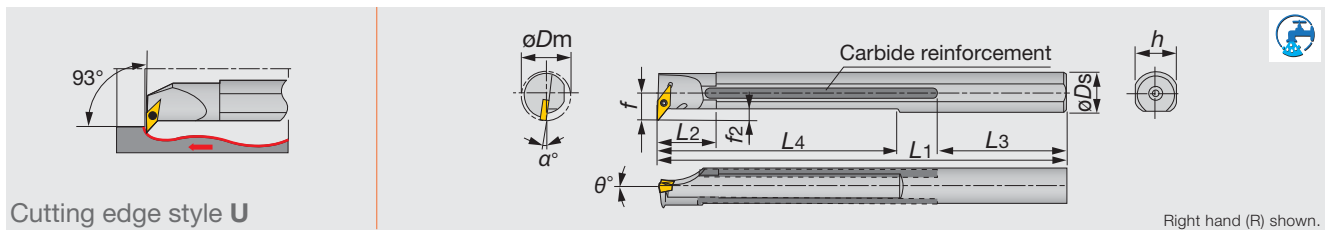

Metric	Material	øDm	Oil hole	øDs	f	L1	L2	L3	L4	h	f2	θ°	α°	re**	Insert	Torque*
T20R-SVUBR11C	TSUPPARI	25	Rc1/4	20	14	200	30	59	121	18	4	0	-8	0.4	VB**1103...	1.2

*Torque: Recommended torque (N-m) for clamping **re: Standard corner radius

Note: When using a right or left hand insert, the right hand insert (R) is used for the left hand toolholders (SVUBL** type), and the left hand insert (L) is used for the right hand toolholders (SVUBR** type).

SPARE PARTS

Designation	Clamping screw	Wrench
T20R-SVUBR11C	CSTB-2.5	T-8F

T-SVUCR

Tsuppari-Ichiban, Screw-on boring bar, for positive 35° rhombic inserts

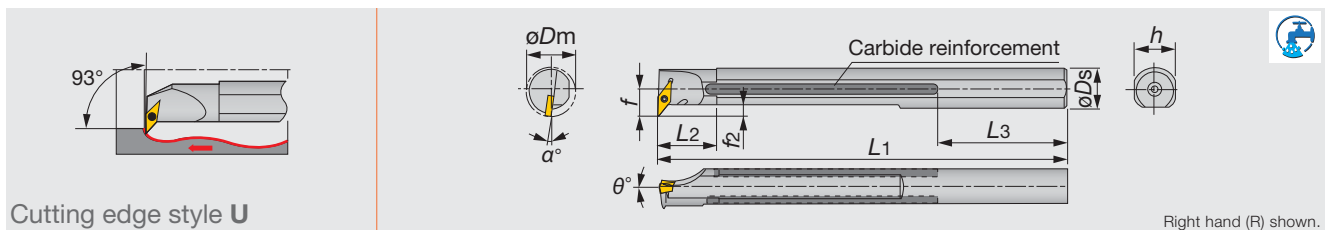

Metric	Material	øDm	Oil hole	øDs	f	L1	L2	L3	h	f2	θ°	α°	re**	Insert	Torque*
T25S-SVUCR16C	TSUPPARI	32	Rc1/4	25	19	250	40	64	23	6.5	0	-5	0.8	VC**1604...	3

*Torque: Recommended torque (N-m) for clamping **re: Standard corner radius

Note: The hole of inserts conforms to ISO standard.

When using a right or left hand insert, the right hand insert (R) is used for left hand toolholders (L) and the left hand insert (L) is used for right hand toolholders (R).

SPARE PARTS

Designation	Clamping screw	Wrench
T25S-SVUCR16C	CSTB-3.5L	T-15F

Reference pages

T-SVUBR: Inserts → B147 -, CBN → B171 -

T-SVUCR: Inserts → B149 -, CBN → B171 -, PCD → B179 -

T-SDQCR/L

Tsuppari-Ichiban, Screw-on boring bar, for positive 55° rhombic inserts

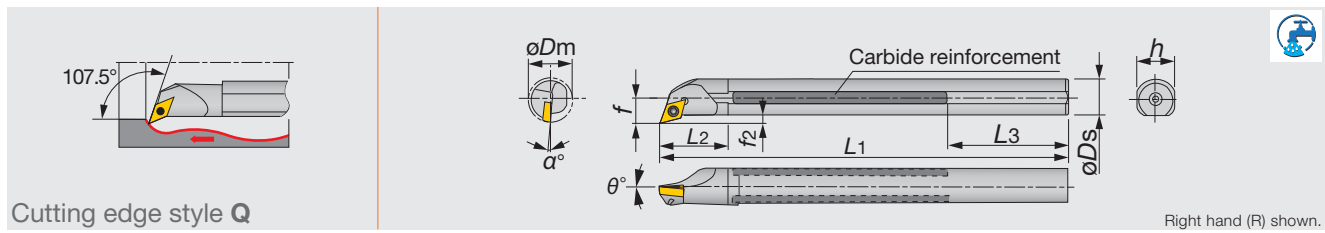

Cutting edge style Q

Right hand (R) shown.

Metric	Material	ϕD_m	Oil hole	ϕD_s	f	L_1	L_2	L_3	h	f_2	θ°	α°	r_{ϵ}^{**}	Insert	Torque*
T16Q-SDQCR/L07	TSUPPARI	20	-	16	11	180	27	59	15	3	0	-6	0.4	DC**0702...	1.2
T20R-SDQCR/L11C	TSUPPARI	25	Rc1/4	20	13	200	35	49	18	3	0	-6	0.8	DC**11T3...	3
T25S-SDQCR/L11C	TSUPPARI	32	Rc1/4	25	17	250	40	64	23	4.5	0	-4	0.8	DC**11T3...	3

*Torque: Recommended torque (N-m) for clamping ** r_{ϵ} : Standard corner radius

Note: The hole of inserts conforms to ISO standard.

When using a right or left hand insert, the right hand insert (R) is used for left hand toolholders (L) and the left hand insert (L) is used for right hand toolholders (R).

SPARE PARTS



Designation	Clamping screw	Wrench
T16Q-SDQCR/L07	CSTB-2.5	T-8F
T20R-SDQCR/L11C	CSTB-4M	T-15F
T25S-SDQCR/L11C	CSTB-4	T-15F



Int. Toolholder

Reference pages

T-SDQCR/L: Inserts → **B116 -**, CBN → **B170 -**, PCD → **B179**

T-SVQBR

Tsuppari-Ichiban, Screw-on boring bar, for positive 35° rhombic inserts

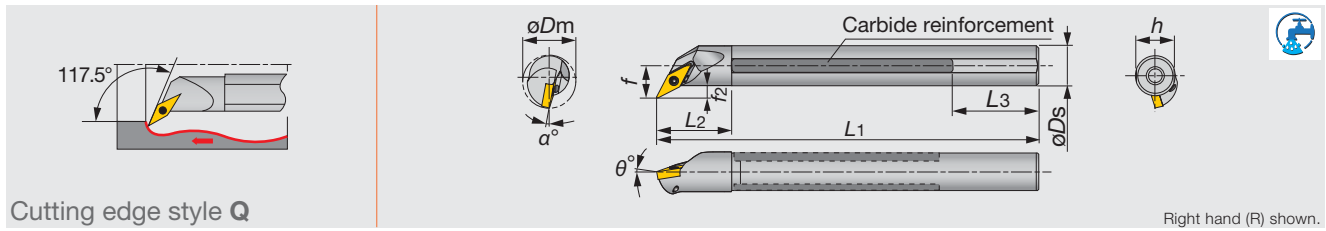

Metric	Material	ϕD_m	Oil hole	ϕD_s	f	L_1	L_2	L_3	h	f_2	θ°	α°	$r_{e^{**}}$	Insert	Torque*
T20R-SVQBR11C	TSUPPARI	25	Rc1/4	20	14	200	30	59	18	4	-5	-7	0.4	VB**1103...	1.2

*Torque: Recommended torque (N-m) for clamping ** r_e : Standard corner radius

Note: The hole of inserts conforms to ISO standard. When using a right or left hand insert, the right hand insert (R) is used for the left hand toolholders (L), and the left hand insert (L) is used for the right hand toolholders (R).

SPARE PARTS

Designation	Clamping screw	Wrench
T20R-SVQBR11C	CSTB-2.5	T-8F

T-SVQCR

Tsuppari-Ichiban, Screw-on boring bar, for positive 35° rhombic inserts

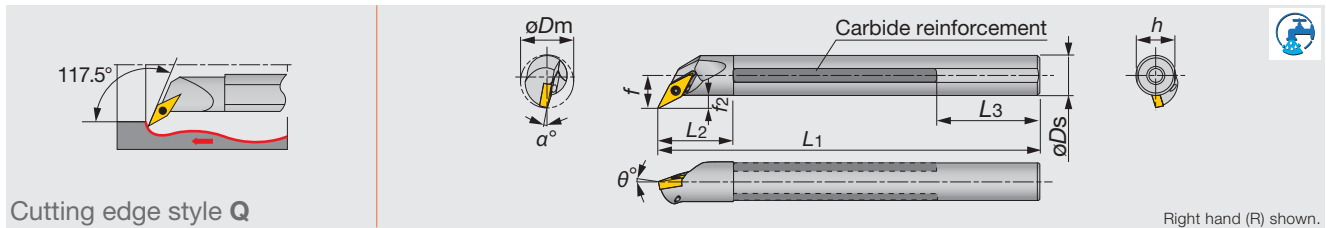

Metric	Material	ϕD_m	Oil hole	ϕD_s	f	L_1	L_2	L_3	h	f_2	θ°	α°	$r_{e^{**}}$	Insert	Torque*
T25S-SVQCR16C	TSUPPARI	32	Rc1/4	25	17	250	40	64	23	8	0	-5	0.8	VC**1604...	3

*Torque: Recommended torque (N-m) for clamping ** r_e : Standard corner radius

Note: The hole of inserts conforms to ISO standard. When using a right or left hand insert, the right hand insert (R) is used for the left hand toolholders (L), and the left hand insert (L) is used for the right hand toolholders (R).

SPARE PARTS

Designation	Clamping screw	Wrench
T25S-SVQCR16C	CSTB-3.5L	T-15F

Reference pages

T-SVQBR: Inserts → B147 -, CBN → B171 -

T-SVQCR: Inserts → B149 -, CBN → B171 -, PCD → B179 -

S-CSKPR/L

Clamp-on boring bar, for positive square inserts

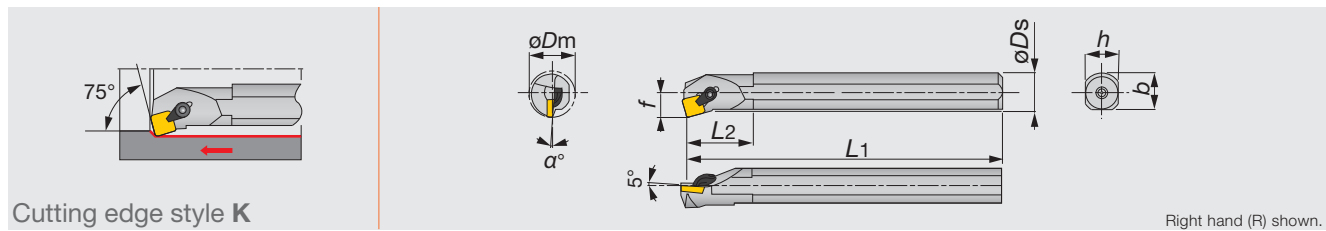

Cutting edge style K

Right hand (R) shown.

Metric	Material	ϕD_m	ϕD_s	f	L_1	L_2	h	b	α°	r_{ϵ}^{**}	Insert
S16Q-CSKPR09	STEEL	20	16	11	180	30	15	15	-4	0.8	SP**0903...
S20R-CSKPR/L09	STEEL	25	20	13	200	40	18	18.5	-2	0.8	SP**0903...
S25S-CSKPR12	STEEL	32	25	17	250	45	23	22.5	0	0.8	SP**1203...

** r_{ϵ} : Standard corner radius

Note: When using a right or left hand insert, the right hand insert (R) is used for left hand toolholders (L) and the left hand insert (L) is used for right hand toolholders (R).

SPARE PARTS

Designation	Clamp set	Wrench
S16Q-CSKPR09	CSG-5S	P-2.5
S20R-CSKPR/L09	CSG-5	P-2.5
S25S-CSKPR12	CSG-6	P-3

S/C-CTFPR/L

Clamp-on style boring bar, for positive triangle inserts

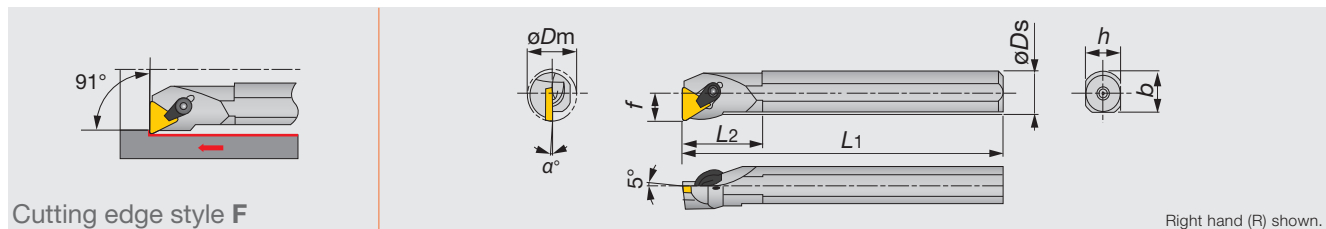

Cutting edge style F

Right hand (R) shown.

Metric	Material	ϕD_m	ϕD_s	f	L_1	L_2	h	b	α°	r_{ϵ}^{**}	Insert
S12M-CTFPR/L11	STEEL	16	12	9	150	25	11	11.5	-6	0.4	TP**1103...
S16Q-CTFPR/L11	STEEL	20	16	11	180	30	15	15	-4	0.4	TP**1103...
S20R-CTFPR/L16	STEEL	25	20	13	200	40	18	18.5	-2	0.8	TP**1603...
S25S-CTFPR/L16	STEEL	32	25	17	250	45	23	22.5	0	0.8	TP**1603...
S32T-CTFPR/L16	STEEL	40	32	22	300	50	30	29.5	0	0.8	TP**1603...
C12Q-CTFPR/L11	CARBIDE	16	12	9	180	-	11	-	-6	0.4	TP**1103...
C16R-CTFPR/L11	CARBIDE	20	16	11	200	-	15	-	-4	0.4	TP**1103...

** r_{ϵ} : Standard corner radius

Note: The hole of inserts conforms to ISO standard.

When using a right or left hand insert, the right hand insert (R) is used for left hand toolholders (L) and the left hand insert (L) is used for right hand toolholders (R).

SPARE PARTS

Designation	Clamp set 1	Clamp set 2	Wrench
S12M-CTFPR/L11	CSW-00	-	P-2.5
S16Q-CTFPR/L11	-	CSG-5S	P-2.5
S20R-CTFPR/L16	-	CSG-6S	P-3
S**-CTFPR/L16	-	CSG-6	P-3
C12Q-CTFPR/L11	CSW-00	-	P-2.5
C16R-CTFPR/L11	-	CSG-5S	P-2.5

Reference pages

S-CSKPR/L: Inserts → **B132**, CBN → **B170**, PCD → **B179**

S/C-CTFPR/L: Inserts → **B145 -**, CBN → **B170 -**, PCD → **B180**

T-PCLNR

Lever-lock boring bar, for negative 80° rhombic inserts

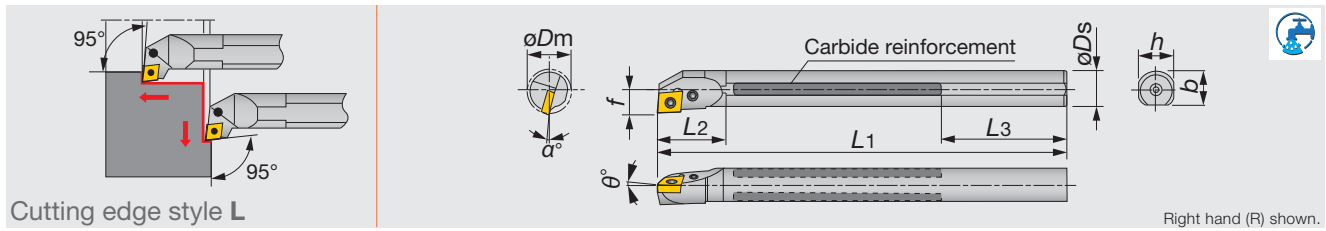

Metric	Material	ϕD_m	Oil hole	ϕD_s	f	L_1	L_2	L_3	h	θ°	α°	$r_{e^{**}}$	Insert	Torque*
T16Q-PCLNR09	TSUPPARI	20	-	16	11	180	27	59	15	-6	-14	0.8	CN**0903...	1.7
T20R-PCLNR09C	TSUPPARI	25	Rc1/4	20	13	200	35	49	18	-6	-12	0.8	CN**0903...	1.7
T25S-PCLNR09C	TSUPPARI	32	Rc1/4	25	17	250	40	64	23	-6	-11	0.8	CN**0903...	1.7
T32U-PCLNR12C	TSUPPARI	40	Rc1/2	32	22	350	50	103	30	-6	-11	0.8	CN**1204...	4.8
T40V-PCLNR12C	TSUPPARI	50	Rc1/2	40	27	400	55	88	37	-6	-10	0.8	CN**1204...	4.8
T50W-PCLNR12C	TSUPPARI	63	Rc1/2	50	35	450	65	63	47	-6	-8	0.8	CN**1204...	4.8

*Torque: Recommended torque (N-m) for clamping ** r_e : Standard corner radius

Note: When using a right or left hand insert, the right hand insert is used for left hand toolholders and the left hand insert is used for right hand toolholders.

SPARE PARTS

Designation	Shim	Clamping screw 1	Clamping screw 2	Wrench 1	Wrench 2	Spring	Lever
T**-PCLNR09...	-	LCS22A	-	P-2F	-	-	LCL32N
T**-PCLNR12C	LSC42BR	-	LCS4	-	P-3	LSP4	LCL4

S-PCLNR/L

Lever-lock boring bar, for negative 80° rhombic inserts

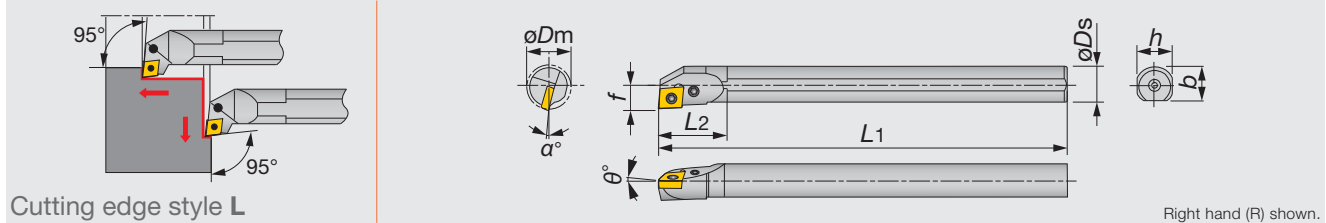

Metric	Material	ϕD_m	ϕD_s	f	L_1	L_2	h	b	θ°	α°	$r_{e^{**}}$	Insert	Torque*
S16M-PCLNR/L09	STEEL	20	16	11	150	30	15	15.5	-6	-14	0.8	CN**0903...	1.7
S20Q-PCLNR/L09	STEEL	25	20	13	180	35	18	19	-6	-12	0.8	CN**0903...	1.7
S25R-PCLNR/L09	STEEL	32	25	17	200	40	23	24	-6	-11	0.8	CN**0903...	1.7
S32S-PCLNR/L12	STEEL	40	32	22	250	50	30	29.5	-6	-11	0.8	CN**1204...	4.8
S40T-PCLNR/L12	STEEL	50	40	27	300	55	37	37.5	-6	-10	0.8	CN**1204...	4.8
S50U-PCLNR/L12	STEEL	63	50	35	350	65	47	47.5	-6	-8	0.8	CN**1204...	4.8

*Torque: Recommended torque (N-m) for clamping ** r_e : Standard corner radius

Note: When using a right or left hand insert, the right hand insert is used for left hand toolholders and the left hand insert is used for right hand toolholders.

SPARE PARTS

Designation	Shim	Clamping screw 1	Clamping screw 2	Wrench 1	Wrench 2	Spring	Lever
S**-PCLNR/L09	-	LCS22A	-	P-2F	-	-	LCL32N
S32S-PCLNR/L12	LSC42BR/L	-	LCS4	-	P-3	LSP4	LCL4
S40T-PCLNR/L12	LSC42BR/L	-	LCS4	-	P-3	LSP4	LCL4
S50U-PCLNR/L12	LSC42BR/L	-	LCS4	-	P-3	LSP4	LCL4

Reference pages

T-PCLNR, S-PCLNR/L: Inserts → B052 -, CBN → B165, PCD → B178

S-PWLNLR/L

Lever-lock boring bar, for negative trigon inserts

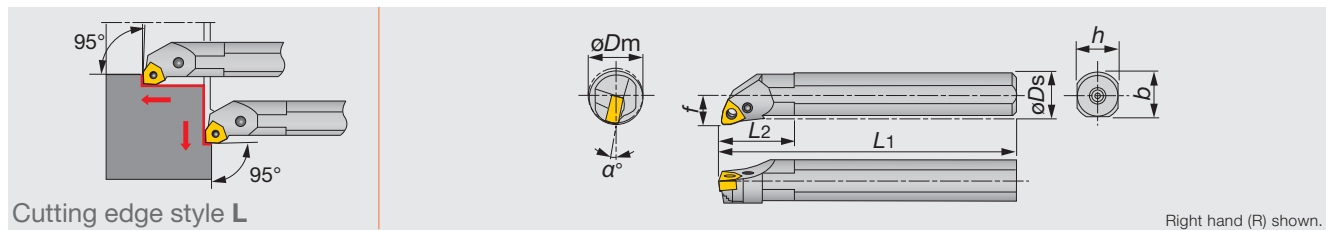

Metric	Material	$\varnothing D_m$	$\varnothing D_s$	f	L_1	L_2	h	b	α°	$r_{e^{**}}$	Insert
S16M-PWLNLR/L06	STEEL	20	16	11	150	30	15	15.5	-17	0.8	WN**0604...
S20Q-PWLNLR/L06	STEEL	25	20	13	180	35	18	19	-14	0.8	WN**0604...
S25R-PWLNLR/L06	STEEL	32	25	17	200	40	23	24	-12	0.8	WN**0604...

** r_e : Standard corner radius

Note: When using a right or left hand insert, the right hand insert is used for left hand toolholders and the left hand insert is used for right hand toolholders.

SPARE PARTS

Designation	Shim	Clamping screw 1	Clamping screw 2	Wrench 1	Wrench 2	Spring	Lever
S**-PWLNLR/L06	-	LCS33	-	P-2F	-	-	LCL33N
S25R-PWLNLR06	LSW312BR	-	LCS3B	-	P-2.5	LSP3	LCL3
S25R-PWLNLR06	LSW312BL	-	LCS3B	-	P-2.5	LSP3	LCL3

S-PSKNR

Lever-lock boring bar, for negative square inserts

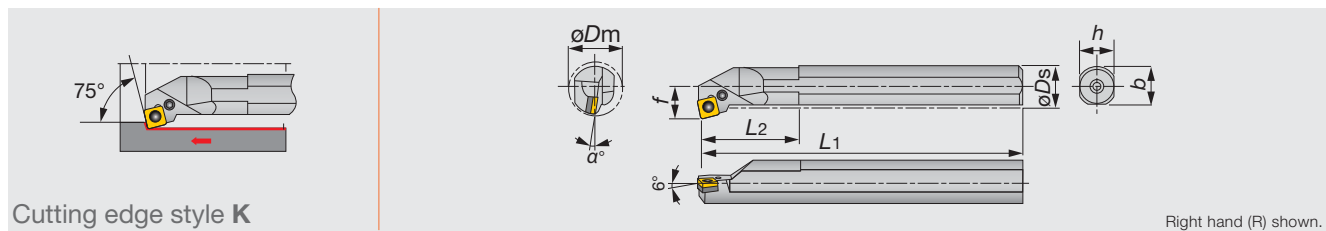

Metric	Material	$\varnothing D_m$	$\varnothing D_s$	f	L_1	L_2	h	b	α°	$r_{e^{**}}$	Insert
S32S-PSKNR12	STEEL	40	32	22	250	50	30	29.5	-10	0.8	SN**1204...
S40T-PSKNR12	STEEL	50	40	27	300	55	37	37.5	-10	0.8	SN**1204...
S50U-PSKNR12	STEEL	63	50	35	350	65	47	47.5	-8	0.8	SN**1204...

** r_e : Standard corner radius

Note: When using a right or left hand insert, the right hand insert is used for left hand toolholders and the left hand insert is used for right hand toolholders.

SPARE PARTS

Designation	Shim	Clamping screw	Wrench	Spring	Lever
S**-PSKNR12	LSS42BR	LCS4	P-3	LSP4	LCL4

Reference pages

S-PWLNLR/L: Inserts → B097 -, CBN → B167

S-PSKNR: Inserts → B073 -, CBN → B166 -, PCD → B178

S-PTFNR/L

Lever lock type boring bar, for negative triangle inserts

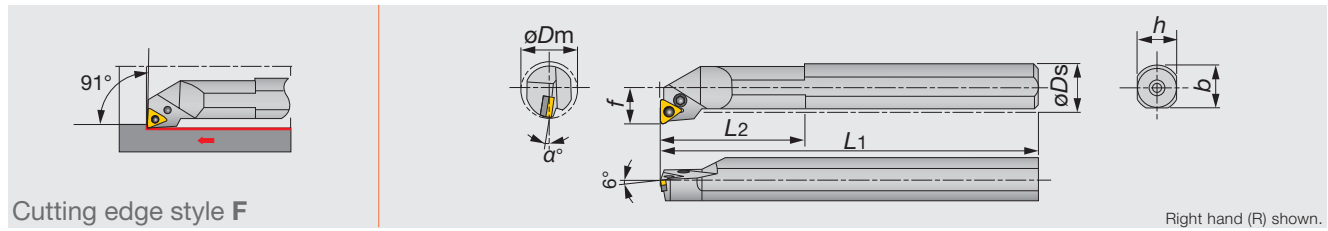

Metric	Material	ϕD_m	ϕD_s	f	L_1	L_2	h	b	α°	$r_{e^{**}}$	Insert	Torque*
S32S-PTFNR/L16	STEEL	40	32	22	250	50	30	29.5	-10	0.8	TN**1604...	2.7
S40T-PTFNR/L16	STEEL	50	40	27	300	55	37	37.5	-10	0.8	TN**1604...	2.7
S50U-PTFNR16	STEEL	63	50	35	350	65	47	47.5	-8	0.8	TN**1604...	2.7

*Torque: Recommended torque (N-m) for clamping ** r_e : Standard corner radius

Note: When using a right or left hand insert, the right hand insert is used for left hand toolholders and the left hand insert is used for right hand toolholders.

SPARE PARTS

Designation	Shim	Clamping screw	Wrench	Spring	Lever
S32S-PTFNR16	LST317BR	LCS3	P-2.5	LSP3	LCL3
S32S-PTFNL16	LST317BL	LCS3	P-2.5	LSP3	LCL3
S40T-PTFNR16	LST317BR	LCS3	P-2.5	LSP3	LCL3
S40T-PTFNL16	LST317BL	LCS3	P-2.5	LSP3	LCL3
S50U-PTFNR16	LST317BR	LCS3	P-2.5	LSP3	LCL3

T-PDUNR

Lever-lock boring bar, for negative 55° rhombic inserts

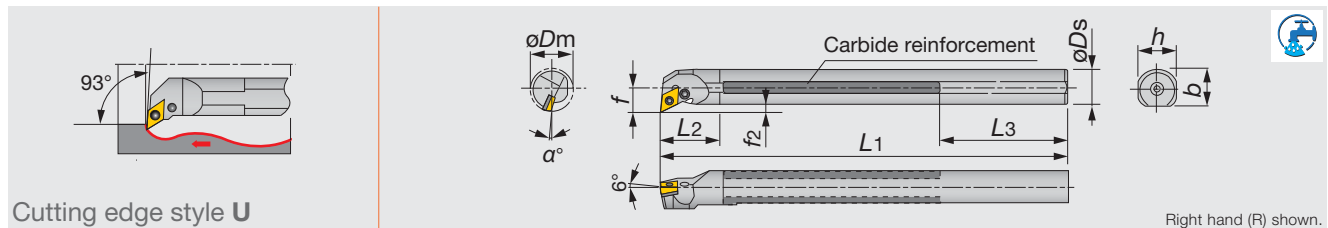

Metric	Material	ϕD_m	Oil hole	ϕD_s	f	L_1	L_2	L_3	h	f_2	α°	$r_{e^{**}}$	Insert
T32U-PDUNR15C	TSUPPARI	40	Rc1/2	32	22	350	50	103	30	6	-13	0.8	DN**1504...
T40V-PDUNR15C	TSUPPARI	50	Rc1/2	40	27	400	55	88	37	7	-10	0.8	DN**1504...
T50W-PDUNR15C	TSUPPARI	63	Rc1/2	50	35	450	65	63	47	10	-8	0.8	DN**1504...

** r_e : Standard corner radius

Note: When using a right or left hand insert, the right hand insert is used for left hand toolholders and the left hand insert is used for right hand toolholders.

SPARE PARTS

Designation	Shim	Clamping screw	Wrench	Spring	Lever
T**-PDUNR15C	LSD42BR	LCS4	P-3	LSP4	LCL4

Reference pages

S-PTFNR/L: Inserts → B082 -, CBN → B166 -, PCD → B178

T-PDUNR: Inserts → B063 -, CBN → B165 -, PCD → B178

S-PDUNR/L

Lever-lock boring bar, for negative 55° rhombic inserts

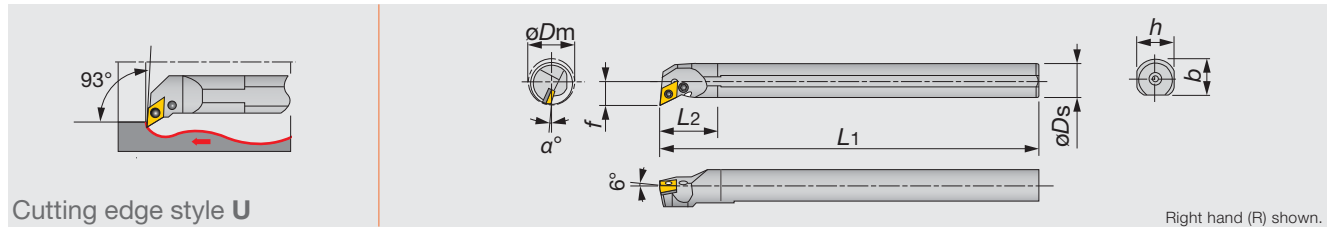

Metric	Material	ϕD_m	ϕD_s	f	L_1	L_2	h	b	α°	r_{ϵ}^{**}	Insert
S20Q-PDUNR/L11	STEEL	25	20	13	180	35	18	19	-14	0.8	DN**1104...
S25R-PDUNR/L11	STEEL	32	25	17	200	40	23	24	-12	0.8	DN**1104...
S32S-PDUNR/L15	STEEL	40	32	22	250	50	30	29.5	-13	0.8	DN**1504...
S40T-PDUNR/L15	STEEL	50	40	27	300	55	37	37.5	-10	0.8	DN**1504...
S50U-PDUNR/L15	STEEL	63	50	35	350	65	47	47.5	-8	0.8	DN**1504...

** r_{ϵ} : Standard corner radius

Note: When using a right or left hand insert, the right hand insert is used for left hand toolholders and the left hand insert is used for right hand toolholders.

SPARE PARTS							
Designation	Shim	Clamping screw 1	Clamping screw 2	Wrench 1	Wrench 2	Spring	Lever
S20Q-PDUNR/L11	-	LCS22A	-	P-2F	-	-	LCL33NL
S25R-PDUNR11	ELSD317BR	-	LCS3	-	P-2.5	LSP3	LCL33L
S25R-PDUNL11	ELSD317BL	-	LCS3	-	P-2.5	LSP3	LCL33L
S32S-PDUNR15	LSD42BR	-	LCS4	-	P-3	LSP4	LCL4
S32S-PDUNL15	LSD42BL	-	LCS4	-	P-3	LSP4	LCL4
S40T-PDUNR15	LSD42BR	-	LCS4	-	P-3	LSP4	LCL4
S40T-PDUNL15	LSD42BL	-	LCS4	-	P-3	LSP4	LCL4
S50U-PDUNR15	LSD42BR	-	LCS4	-	P-3	LSP4	LCL4
S50U-PDUNL15	LSD42BL	-	LCS4	-	P-3	LSP4	LCL4

T-PTUNR

Lever-lock boring bar, for negative triangle inserts

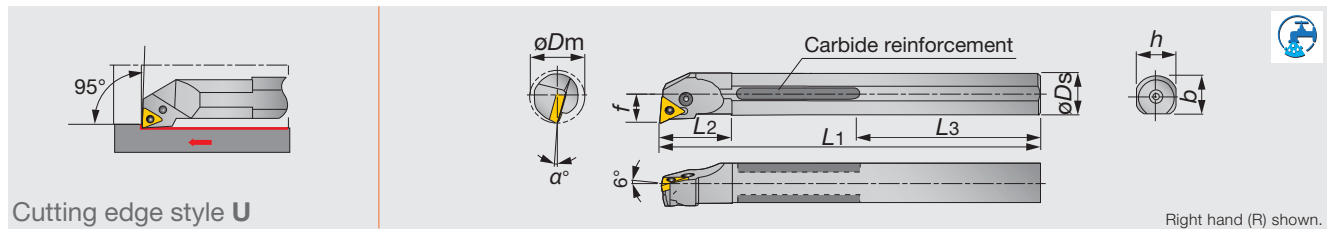

Metric	Material	ϕD_m	Oil hole	ϕD_s	f	L_1	L_2	L_3	h	α°	r_{ϵ}^{**}	Insert	Torque*
T16Q-PTUNR11	TSUPPARI	20	-	16	11	180	27	59	15	-14	0.4	TN**1103...	1.7
T20R-PTUNR11C	TSUPPARI	25	Rc1/4	20	13	200	35	49	18	-12	0.4	TN**1103...	1.7
T25S-PTUNR16C	TSUPPARI	32	Rc1/4	25	17	250	40	64	23	-12	0.8	TN**1604...	2.7
T32U-PTUNR16C	TSUPPARI	40	Rc1/2	32	22	350	50	103	30	-10	0.8	TN**1604...	2.7
T40V-PTUNR16C	TSUPPARI	50	Rc1/2	40	27	400	55	88	37	-10	0.8	TN**1604...	2.7
T50W-PTUNR16C	TSUPPARI	63	Rc1/2	50	35	450	65	63	47	-8	0.8	TN**1604...	2.7

*Torque: Recommended torque (N-m) for clamping ** r_{ϵ} : Standard corner radius

Note: • The hole of inserts conforms to ISO standard.

• Toolholder lengths do not always conform to ISO.

• When using a right or left hand insert, the right hand insert is used for left hand toolholders and the left hand insert is used for right hand toolholders.

SPARE PARTS							
Designation	Shim	Clamping screw 1	Clamping screw 2	Wrench 1	Wrench 2	Spring	Lever
T**-PTUNR11...	-	LCS22A	-	P-2F	-	-	LCL22N
T25S-PTUNR16C	ELST317BR	-	LCS3	-	P-2.5	LSP3	LCL33
T**-PTUNR16C	LST317BR	-	LCS3	-	P-2.5	LSP3	LCL3

Reference pages

S-PDUNR/L: Inserts → **B063** -, CBN → **B165** -, PCD → **B178**

T-PTUNR: Inserts → **B082** -, CBN → **B166** -, PCD → **B178**

A/S-PTUNR/L

Lever lock type boring bar, for negative triangle inserts

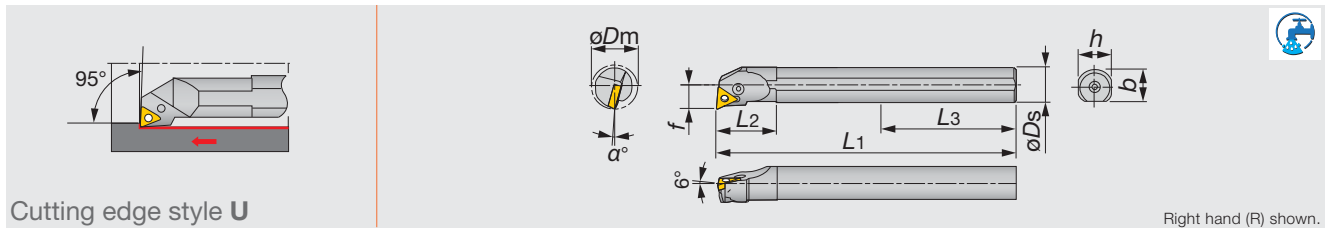

Cutting edge style U

Right hand (R) shown.

Metric	Material	ϕD_m	ϕD_s	f	L_1	L_2	h	b	α°	r_{ϵ}^{**}	Insert	Torque*
S16M-PTUNR/L11	STEEL	20	16	11	150	30	15	15.5	-14	0.4	TN**1103...	1.7
S20Q-PTUNR/L11	STEEL	25	20	13	180	35	18	19	-12	0.4	TN**1103...	1.7
S25R-PTUNR/L16	STEEL	32	25	17	200	40	23	24	-12	0.8	TN**1604...	2.7
A32S-PTUNR/L16	STEEL	40	32	22	250	50	30	29.5	-12	0.8	TN**1604...	2.7

*Torque: Recommended torque (N-m) for clamping ** r_{ϵ} : Standard corner radius

Note: • The hole of inserts conforms to ISO standard.

• Toolholder lengths do not always conform to ISO.

• When using a right or left hand insert, the right hand insert is used for left hand toolholders and the left hand insert is used for right hand toolholders.

SPARE PARTS

Designation	Shim	Clamping screw 1	Clamping screw 2	Wrench 1	Wrench 2	Spring	Lever	Oil supply attachment (Optional parts)
S**-PTUNR/L11	-	LCS22A	-	P-2F	-	-	LCL22N	-
S25R-PTUNR16	ELST317BR	-	LCS3	-	P-2.5	LSP3	LCL33	-
S25R-PTUNL16	ELST317BL	-	LCS3	-	P-2.5	LSP3	LCL33	-
A32S-PTUNR16	LST317BR	-	LCS3	-	P-2.5	LSP3	LCL3	(EA-32)
A32S-PTUNL16	LST317BL	-	LCS3	-	P-2.5	LSP3	LCL3	(EA-32)

S-PDZNR/L

Lever-lock boring bar, for negative 55° rhombic inserts

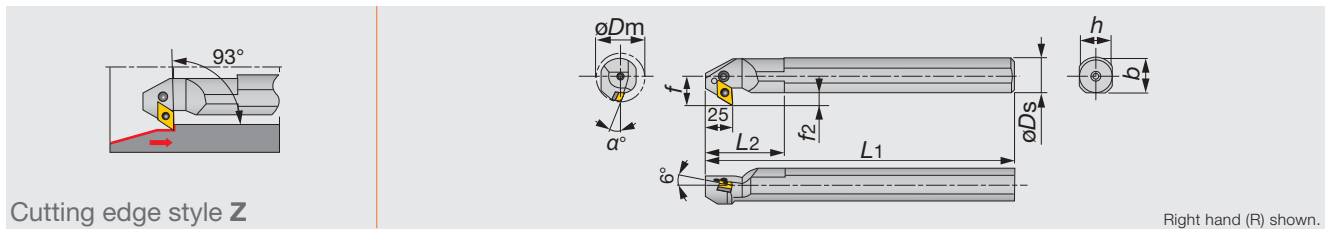

Cutting edge style Z

Right hand (R) shown.

Metric	Material	ϕD_m	ϕD_s	f	L_1	L_2	h	f_2	b	α°	r_{ϵ}^{**}	Insert
S32S-PDZNR/L15	STEEL	40	32	22	275	55	30	6	29.5	-13	0.8	DN**1504...
S40T-PDZNR15	STEEL	50	40	27	325	60	37	7	37.5	-10	0.8	DN**1504...
S50U-PDZNR15	STEEL	60	50	35	375	65	47	10	47.5	-8	0.8	DN**1504...

** r_{ϵ} : Standard corner radius

Note: When using a right or left hand insert, the right hand insert is used for right hand toolholders and the left hand insert is used for left hand toolholders.

SPARE PARTS

Designation	Shim	Clamping screw	Wrench	Spring	Lever
S32S-PDZNR15	LSZ42BR	LCS4	P-3	LSP4	LCL4
S32S-PDZNL15	LSZ42BL	LCS4	P-3	LSP4	LCL4
S*0°-PDZNR15	LSZ42BR	LCS4	P-3	LSP4	LCL4

Reference pages

A/S-PTUNR/L: Inserts → B082 -, CBN → B166 -, PCD → B178

S-PDZNR/L: Inserts → B063 -, CBN → B165 -, PCD → B178

S-MCLNR/L

Multi-clamp boring bar, for negative 80° rhombic inserts

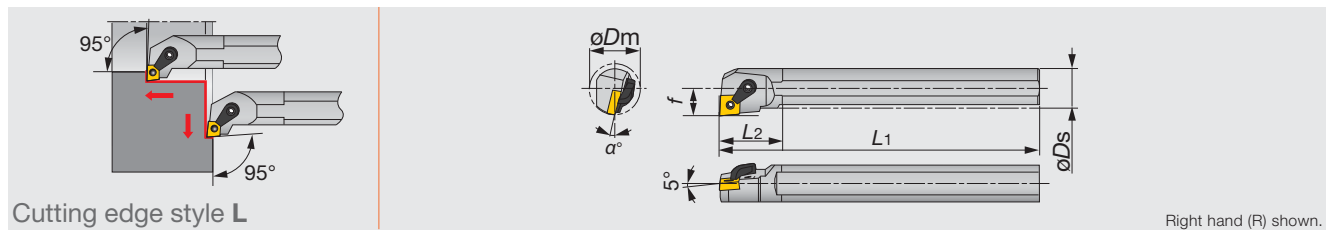

Metric	Material	ϕD_m	ϕD_s	f	L_1	L_2	h	b	α°	$r\epsilon^{**}$	Insert
S25R-MCLNR/L12	STEEL	32	25	17	200	40	23	22.5	-12	0.8	CN**1204...

** $r\epsilon$: Standard corner radius

Note: When using a right or left hand insert, the right hand insert (R) is used for the left hand toolholders (MCLNL** type), and the left hand insert (L) is used for the right hand toolholders (MCLNR** type).

SPARE PARTS

Designation	Clamp	Pin	Clamping screw	Wrench 1	Wrench 2
S25R-MCLNR/L12	MCPM-21	MLP44	MCS620-3	P-3	P-2.5F

S-MWLNR/L

Multi-clamp boring bar, for negative trigon inserts

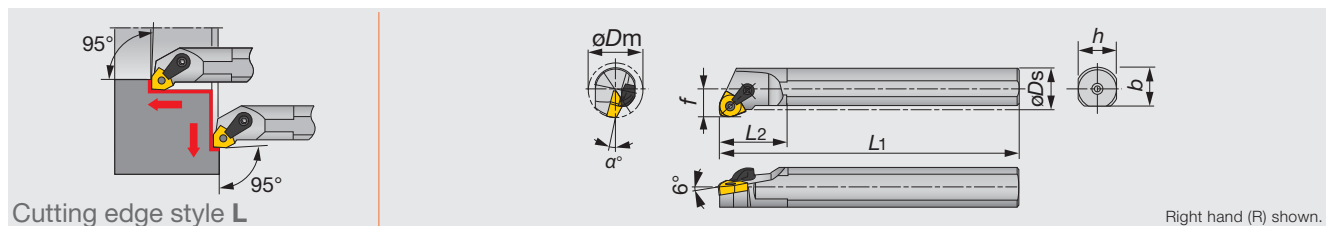

Metric	Material	ϕD_m	ϕD_s	f	L_1	L_2	h	b	α°	$r\epsilon^{**}$	Insert
S25R-MWLNR/L08	STEEL	32	25	17	200	40	23	22.5	-12	0.8	WN**0804...
S32S-MWLNR/L08	STEEL	44	32	22	250	50	30	29.5	-10	0.8	WN**0804...
S40T-MWLNR/L08	STEEL	54	40	27	300	60	37	37.5	-10	0.8	WN**0804...
S50U-MWLNR/L08	STEEL	70	50	35	350	75	47	47.5	-10	0.8	WN**0804...

** $r\epsilon$: Standard corner radius

SPARE PARTS

Designation	Clamp	Pin	Clamping screw	Shim	Wrench 1	Wrench 2
S25R-MWLNR/L08	MCPM-6	MLP44	MCS520-2.5	-	P-2.5	P-2.5F
S32S-MWLNR/L08	MCPM-6	MLP46	MCS520-2.5	MSW-432BR/L	P-2.5	P-2.5F
S40T-MWLNR/L08	MCPM-6	MLP46	MCS520-2.5	MSW-432BR/L	P-2.5	P-2.5F
S50U-MWLNR/L08	MCPM-6	MLP46	MCS520-2.5	MSW-432BR/L	P-2.5	P-2.5F

Reference pages

S-MCLNR/L: Inserts → B052 -, CBN → B165 -, PCD → B178

S-MWLNR/L: Inserts → B097 -, CBN → B167

S-MSKNR/L

Multi-clamp boring bar, for negative square inserts

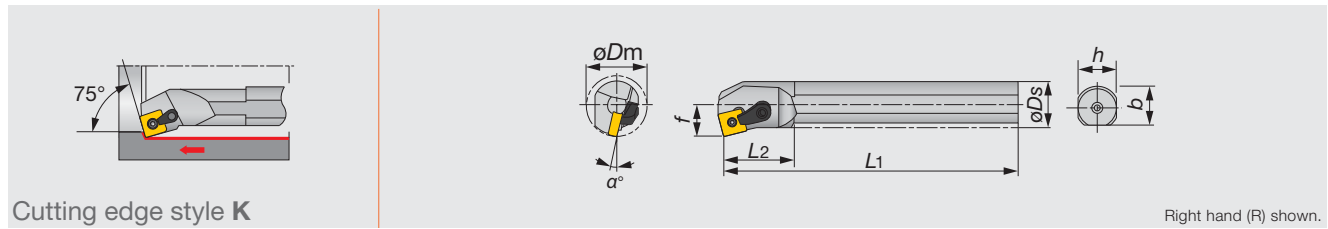

Metric	Material	ϕD_m	ϕD_s	f	L_1	L_2	h	b	α°	r_{ϵ}^{**}	Insert
S25R-MSKNR/L12	STEEL	32	25	17	200	40	23	22.5	-12	0.8	SN**1204...

** r_{ϵ} : Standard corner radius

Note: When using a right or left hand insert, the right hand insert (R) is used for the left hand toolholders (MSKNL** type), and the left hand insert (L) is used for the right hand toolholders (MSKNR** type).

SPARE PARTS

Designation	Clamp	Pin	Clamping screw	Wrench 1	Wrench 2
S25R-MSKNR/L12	MCPM-21 MCL-6*	MLP44	MCS620-3	P-3	P-2.5F

Note: * marked parts type No. in former type No.

S-MTFNR/L

Multi-clamp boring bar, for negative triangle inserts

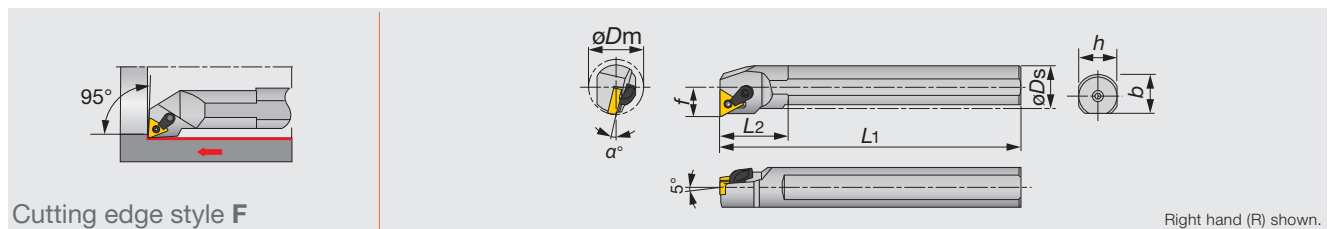

Metric	Material	ϕD_m	ϕD_s	f	L_1	L_2	h	b	α°	r_{ϵ}^{**}	Insert
S25R-MTFNR/L16	STEEL	32	25	17	200	40	23	22.5	-12	0.8	TN**1604...

** r_{ϵ} : Standard corner radius

Note: When using a right or left hand insert, the right hand insert (R) is used for the left hand toolholders (MTFNL** type), and the left hand insert (L) is used for the right hand toolholders (MTFNR** type).

SPARE PARTS

Designation	Clamp	Pin	Clamping screw	Wrench1	Wrench 2
S25R-MTFNR/L16	MCPM-6 MCL-5M*	MLP33L	MCS520-2.5	P-2.5	P-2F

Note: * marked parts type No. in former type No.

Reference pages

S-MSKNR/L: Inserts → **B073 -**, CBN → **B166 -**, PCD → **B178**

S-MTFNR/L: Inserts → **B082 -**, CBN → **B166 -**, PCD → **B178**

S-MDUNR/L

Multi-clamp boring bar, for negative 55° rhombic inserts

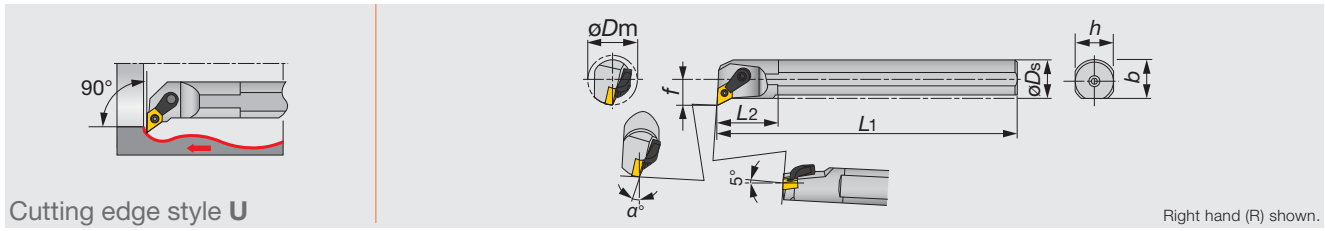

Metric	Material	ϕD_m	ϕD_s	f	L_1	L_2	h	b	α°	r_{ϵ}^{**}	Insert
S25R-MDUNR/L11	STEEL	32	25	17	200	40	23	22.5	-12	0.8	DN**1104...

** r_{ϵ} : Standard corner radius

Note: When using a right or left hand insert, the right hand insert (R) is used for the left hand toolholders (MDUNL** type), and the left hand insert (L) is used for the right hand toolholders (MDUNR** type).

SPARE PARTS

Designation	Clamp	Pin	Clamping screw	Wrench 1	Wrench 2
S25R-MDUNR/L11	MCPM-21 MCL-6*	MLP33L	MCS620-3	P-3	P-2F

Note: * marked parts type No. in former type No.

Int. Toolholder

Reference pages

S-MDUNR/L: Inserts → **B063** -

BLM sleeves

Standard Sleeves for SJB-Mini series with round shank

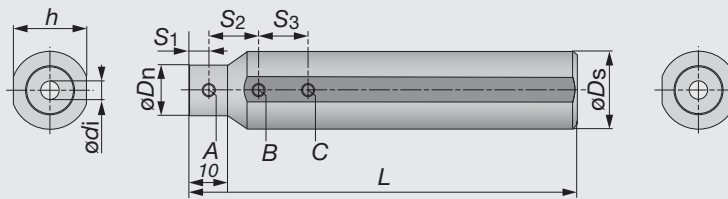

Int. Toolholder

Metric	øDs	øDi	øDn	L	h	S1	S2	S3
BLM159-04	15.875 (0.625")	4	15	100	15	5	15	15
BLM159-05	15.875 (0.625")	5	15	100	15	5	15	15
BLM159-06	15.875 (0.625")	6	15	100	15	5	20	20
BLM159-07	15.875 (0.625")	7	15	100	15	5	20	20
BLM16-04	16	4	15	100	15	5	15	15
BLM16-05	16	5	15	100	15	5	15	15
BLM16-06	16	6	15	100	15	5	20	20
BLM16-07	16	7	15	100	15	5	20	20
BLM19-04	19.05 (0.750")	4	18	100	18	5	15	15
BLM19-05	19.05 (0.750")	5	18	100	18	5	15	15
BLM19-06	19.05 (0.750")	6	18	100	18	5	20	20
BLM19-07	19.05 (0.750")	7	18	100	18	5	20	20
BLM20-04	20	4	13	100	19	5	15	15
BLM20-05	20	5	14	100	19	5	15	15
BLM20-06	20	6	15	100	19	5	20	20
BLM20-07	20	7	16	100	19	5	20	20
BLM22-04	22	4	13	125	21	5	15	15
BLM22-05	22	5	14	125	21	5	15	15
BLM22-06	22	6	15	125	21	5	20	20
BLM22-07	22	7	16	125	21	5	20	20
BLM25-04	25	4	13	125	24	5	15	15
BLM25-05	25	5	14	125	24	5	15	15
BLM25-06	25	6	15	125	24	5	20	20
BLM25-07	25	7	16	125	24	5	20	20
BLM254-04	25.4 (1.000")	4	13	125	24	5	15	15
BLM254-05	25.4 (1.000")	5	14	125	24	5	15	15
BLM254-06	25.4 (1.000")	6	15	125	24	5	20	20
BLM254-07	25.4 (1.000")	7	16	125	24	5	20	20

SPARE PARTS



Designation	Clamping screw A	Clamping screw B, C	Wrench	Seal cap (Optional parts: inner screw)
BLM159, 16...	SSHM4-4	SSHM4-4	P-2	CA-16(M6)
BLM19-04	SSHM4-4	SSHM4-6	P-2	CA-16(M6)
BLM19-05, 06, 07	SSHM4-4	SSHM4-4	P-2	CA-16(M6)
BLM20-04, 05	SSHM4-4	SSHM4-6	P-2	CA-16(M6)
BLM20-06, 07	SSHM4-4	SSHM4-4	P-2	CA-16(M6)
BLM22-...	SSHM4-4	SSHM4-6	P-2	CA-16(M6)
BLM25-04, 05	SSHM4-4	SSHM4-8	P-2	CA-16(M6)
BLM25-06	SSHM4-4	SSHM4-8	P-2	CA-16(M6)
BLM25-07	SSHM4-4	SSHM4-6	P-2	CA-16(M6)
BLM254-04, 05, 06	SSHM4-4	SSHM4-8	P-2	CA-16(M6)
BLM254-07	SSHM4-4	SSHM4-6	P-2	CA-16(M6)

BLS sleeves

Sleeves for boring bars with square shank (regular length)

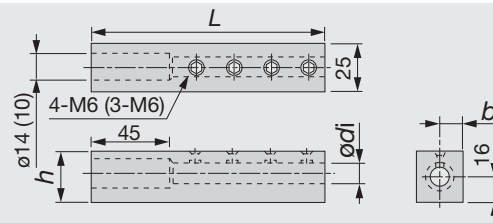

Metric	ødi	L	h	b
BLS16-08	8	125	28	12.5
BLS16-10	10	125	28	12.5
BLS16-12	12	125	28	12.5

SPARE PARTS



Designation	Wrench
BLS16-...	P-3

BLS-C sleeves

Sleeves for boring bars with square shank (short type)

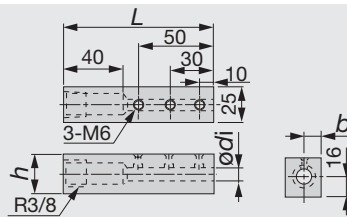

Metric	ødi	L	h	b
BLS16-08C	8	100	28	12.5
BLS16-10C	10	100	28	12.5
BLS16-12C	12	100	28	12.5

SPARE PARTS



Designation	Wrench
BLS16-**C	P-3



Int. Toolholder

BLM sleeves

Sleeves for boring bars with round shank

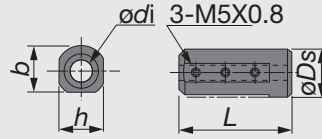

Metric	$\varnothing d_i$	$\varnothing D_s$	L	h	b
BLM19-08	8	19.05	100	18	18
BLM20-08	8	20	100	19	18
BLM22-08	8	22	125	21	21
BLM254-08	8	25.4	125	24	24
BLM25-08C	8	25	55	24	23
BLM25-10C	10	25	55	24	23
BLM25-12C	12	25	55	24	23

SPARE PARTS

Designation	Wrench
BLM...	P-2.5

BLC sleeves

Standard Sleeves for boring bars with round shank

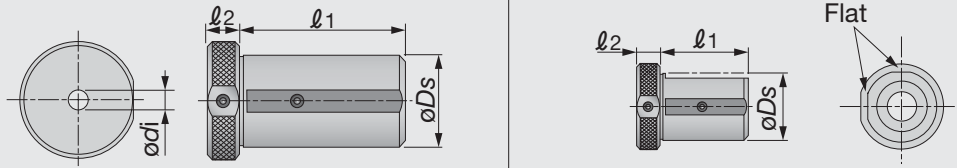

Metric	$\varnothing d_i$	l_1	$\varnothing 2$	$\varnothing D_s$
BLC40-8	8	73	13	40
BLC40-10	10	73	13	40
BLC40-12	12	73	13	40
BLC40-16	16	73	13	40
BLC32-8C	8	45	20	32
BLC32-10C	10	45	20	32
BLC32-12C	12	45	20	32
BLC40-8C	8	55	13	40
BLC40-10C	10	55	13	40
BLC40-12C	12	55	13	40
BLC40-16C	16	55	13	40

SPARE PARTS

Designation	Wrench
BLC40-8	P-3
BLC40-1...	P-4
BLC32-8C	P-3
BLC32-1°C	P-4
BLC40-8C	P-3
BLC40-1°C	P-4

TUNG T^{URN}JET

C-PCLNL-CHP

Lever lock type internal toolholder with TungCap connection with 95° approach angle. For negative 80° rhombic insert. High-pressure coolant capability.

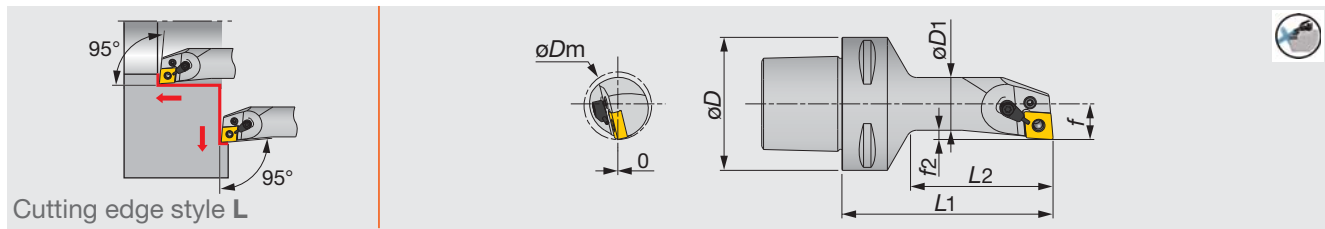

Metric	ϕD_m	ϕD	ϕD_1	L_1	L_2	f	f_2	r_{ϵ}^{**}	Insert
C6PCLNL17100-12-CHP	32	63	25	100	67.5	17	4.5	0.8	CN**1204...

Applicable for 14 MPa pressure coolant
 ** r_{ϵ} : Standard corner radius

SPARE PARTS

Designation	Clamping screw	Coolant unit	Wrench	Lever
C6PCLNL17100-12-CHP	LCS43	S-CU-CHP	P-2.5F	LCL43N

Int. Toolholder

TUNG T^{URN}JET

C-PDUNL-CHP

Lever lock type internal toolholder with TungCap connection with 93° approach angle. For negative 55° rhombic insert. High-pressure coolant capability.

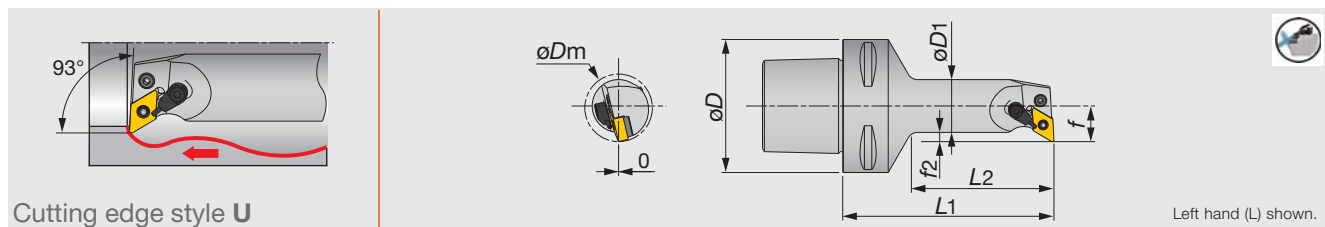

Metric	ϕD_m	ϕD	ϕD_1	L_1	L_2	f	f_2	r_{ϵ}^{**}	Insert
C6PDUNL17100-1104-CHP	32	63	25	100	67.5	17	4.5	0.8	DN**1104...

Applicable for 14 MPa pressure coolant
 ** r_{ϵ} : Standard corner radius

SPARE PARTS

Designation	Shim	Clamping screw	Coolant unit	Wrench	Spring pin	Lever
C6PDUNL17100-1104-CHP	ELSD317BL	LCS43	S-CU-CHP	P-2.5	LSP3	LCL33L

Reference pages

C-PCLNL-CHP: Inserts → B052 -, CBN → B165 -, PCD → B178

C-PDUNL-CHP: Inserts → B063 -, CBN → B165 -, PCD → B178

TurnLine - Miniature Machining

			Inch	Metric
	MINIFORCE Economical double-sided inserts with excellent sharpness 	<u>B190, B288</u>	<input checked="" type="checkbox"/>	<input checked="" type="checkbox"/>
	J-SERIES Toolholders for small-part machining 	<u>B362</u>	<input checked="" type="checkbox"/>	<input checked="" type="checkbox"/>
	TINYM^{INI}TURN Solid boring bars for turning small diameters with high precision 	<u>B386</u>	<input type="checkbox"/>	<input checked="" type="checkbox"/>
Other Tool for Miniature Machining		<u>B409</u>	<input type="checkbox"/>	<input checked="" type="checkbox"/>
	DUOJUST Innovative clamping system for stable parting operations $W = 0.039 - 0.079"$	<u>C009</u>	<input checked="" type="checkbox"/>	<input checked="" type="checkbox"/>
	TETRAFORCE 4-cornered inserts with good clamping rigidity for highly precise grooving and parting  $W = 0.02 - 0.125"$	<u>C047</u>	<input checked="" type="checkbox"/>	<input type="checkbox"/>
	TETRAMCUT Unique insert geometry for highly precise grooving $W = 0.013 - 0.118"$	<u>C055</u>	<input checked="" type="checkbox"/>	<input checked="" type="checkbox"/>
	TUNG CUT Multi-functional tool series for various grooving operations $W = 0.055 - 0.315"$	<u>C059</u>	<input checked="" type="checkbox"/>	<input checked="" type="checkbox"/>
	TUNG^{HEAVY}GROOVE Highly rigid clamping system for wide grooving and profiling in one pass  $W = 0.394 - 0.984"$	<u>C137</u>	<input checked="" type="checkbox"/>	<input type="checkbox"/>

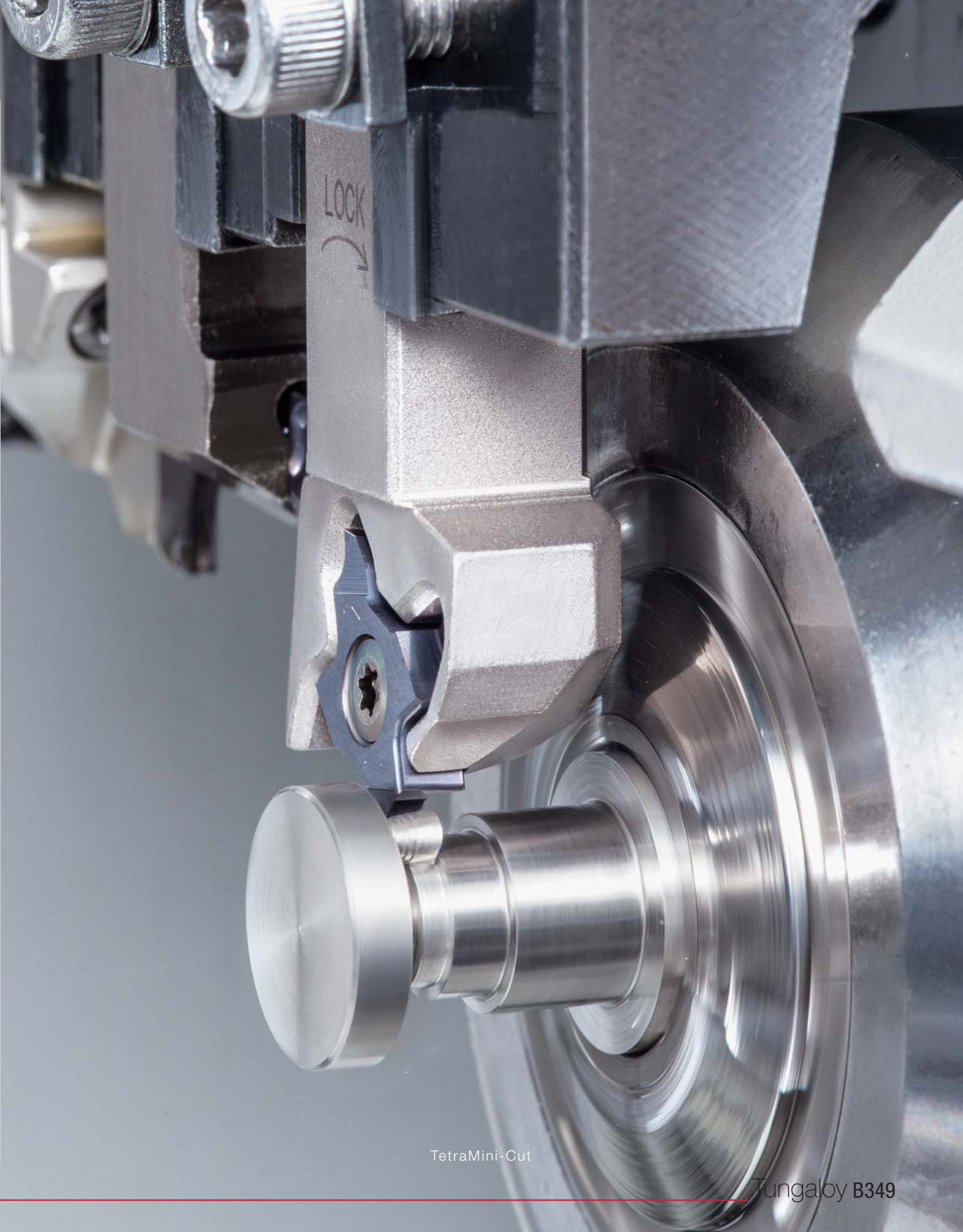

TetraMini-Cut

Tungaloy B349

Miniature External Turning - Quick Guide





Facing

Metric

Style	Description	Type of insert		Shank Size	Clamping style	See page
		Positive	Negative			
	JSDFCR/L Cutting edge angle 91° Insert type: DC□□	✓		12 - 16 mm	Screw-on clamping with offset	B369

External Turning

Metric





Style	Description	Type of insert		Shank Size	Clamping style	See page
		Positive	Negative			
	JTTACR/L Cutting edge angle 91° Insert type: TC□□	✓		8 - 16 mm	Back side clamping without offset	B370
	JSTACR/L Cutting edge angle 91° Insert type: TC□□	✓		8 - 16 mm	Screw-on clamping without offset	B370
	JSCGCR/L Cutting edge angle 91° Insert type: CC□□	✓		12 - 16 mm	Screw-on clamping with offset	B365
	JSCACL Cutting edge angle 91° Insert type: CC□□	✓		10 - 12 mm	Screw-on clamping without offset	B364
	JTTANR/L Cutting edge angle 91° Insert type: TN□□		✓	12 - 16 mm	Back side clamping without offset	B377

Back Turning

Inch

Style	Description	Type of insert		Shank Size	Clamping style	See page
		Positive	Negative			
	JSTBR/L Insert type: JTBR/L3□□	✓		0.375" - 0.625"	Screw-on clamping	B381

Metric

Style	Description	Type of insert		Shank Size	Clamping style	See page
		Positive	Negative			
	JSTBR/L Insert type: JTBR/L3□□	✓		10 - 16 mm	Screw-on clamping	B381
	JS-TBL3 Insert type: JTBR3□□	✓		ø19.05 - 25.4 mm	Screw-on clamping	B381
	JSEGR/L Insert type: J10ER/L□□	✓		10 - 16 mm	Screw-on clamping	B383
	JSXBR/L Insert type: JXBR/L8□□	✓		10 - 25 mm	Screw-on clamping	B380



Miniature Tool

Front & Reverse Turning

Metric

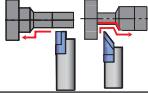
Style	Description	Type of insert		Shank Size	Clamping style	See page
		Positive	Negative			
	JSXGR/L Insert type: JXFR/L8 JXRR/L8	✓		10 - 25 mm	Screw-on clamping	B379

External Turning & Facing

Inch

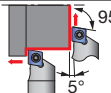
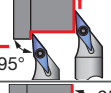
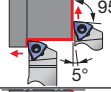
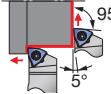
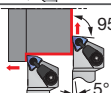
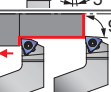
Style	Description	Type of insert		Shank Size	Clamping style	See page
		Positive	Negative			
	JSCL2CR/L Cutting edge angle 95° Insert type: CC□□	✓		0.375" - 0.625"	Screw-on clamping without offset	B362
	JSVL2PR/L Cutting edge angle 95° Insert type: VP□□	✓		0.500" - 0.625"	Screw-on clamping without offset	B375
	JPWL2XR/L Cutting edge angle 95° Insert type: WXGU	✓		0.375" - 0.625"	Side clamping without offset	B190
	JSWL2XR/L Cutting edge angle 95° Insert type: WXGU	✓		0.375" - 0.625"	Screw-on clamping without offset	B190
	JSWL2XR/L-CHP Cutting edge angle 95° Insert type: WXGU	✓		0.500"	Screw-on clamping without offset	B191
	JSWLXR-F Cutting edge angle 95° Insert type: WXGU	✓		0.500" - 0.625"	Screw-on clamping with offset	B191





Miniature Tool

Miniature External Turning - Quick Guide

External Turning & Facing

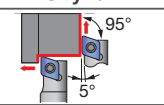
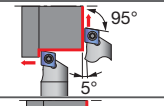
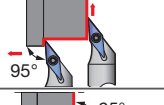
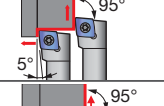
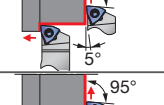
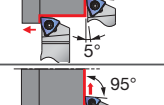
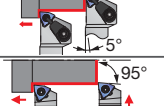
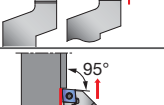
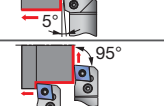
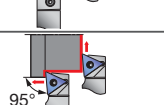
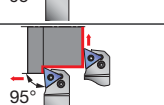

Metric

Style	Description	Type of insert		Shank Size	Clamping style	See page
		Positive	Negative			
	JTCL2CR/L Cutting edge angle 95° Insert type: CC□□	✓		8 - 16 mm	Back side clamping without offset	B362
	JSCL2CR/L Cutting edge angle 95° Insert type: CC□□	✓		10 - 16 mm	Screw-on clamping without offset	B362
	JSVL2PR/L Cutting edge angle 95° Insert type: VP□□	✓		10 - 16 mm	Screw-on clamping without offset	B375
	JSCLCR/L Cutting edge angle 95° Insert type: CC□□	✓		8 - 16 mm	Screw-on clamping with offset	B363
	JPWL2XR/L Cutting edge angle 95° Insert type: WXGU	✓		10 - 16 mm	Side clamping without offset	B190
	JSWL2XR/L Cutting edge angle 95° Insert type: WXGU	✓		10 - 20 mm	Screw-on clamping without offset	B190
	JSWL2XR/L-CHP Cutting edge angle 95° Insert type: WXGU	✓		12 mm	Screw-on clamping without offset	B191
	JSWLXR-F Cutting edge angle 95° Insert type: WXGU	✓		10 - 16 mm	Screw-on clamping with offset	B191
	PCLNR Cutting edge angle 95° Insert type: CN□□		✓	20 mm	Lever-lock clamping with offset	B376
	PCL2NR Cutting edge angle 95° Insert type: CN□□		✓	20 mm	Lever-lock clamping without offset	B376
	JTTLNR/L Cutting edge angle 95° Insert type: TN□□		✓	12 - 16 mm	Back side clamping without offset	B377
	PTL2NR/L Cutting edge angle 95° Insert type: TN□□		✓	20 mm	Lever-lock clamping without offset	B378

Miniature Tool

External Turning & Profiling

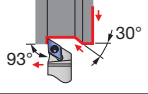
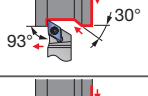
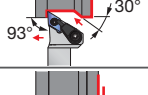
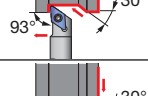
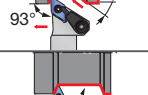
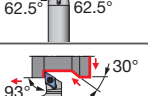
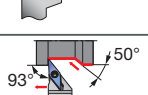
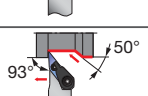
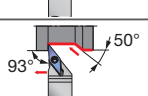
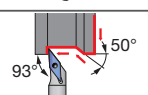
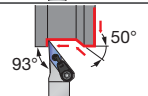
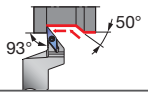
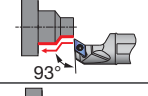
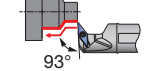
Inch

Style	Description	Type of insert		Shank Size	Clamping style	See page
		Positive	Negative			
	JPDJ2XR/L Cutting edge angle 93° Insert type: DXGU	✓		0.375" - 0.625"	Side clamping without offset	B192
	JSDJ2XR/L Cutting edge angle 93° Insert type: DXGU	✓		0.375" - 0.625"	Screw-on clamping without offset	B192
	JSDJ2XR/L-CHP Cutting edge angle 93° Insert type: DXGU	✓		0.500"	Screw-on clamping without offset	B193
	JSDJ2CR/L Cutting edge angle 93° Insert type: DC□□	✓		0.375" - 0.625"	Screw-on clamping without offset	B365
	JSDJ2CR/L-CHP Cutting edge angle 93° Insert type: DC□□	✓		0.500"	Screw-on clamping without offset	B367
	JSDNCN Cutting edge angle 62.5° Insert type: DC□□	✓		0.375" - 0.625"	Screw-on clamping with offset	B368
	JSDJXR-F Cutting edge angle 93° Insert type: DXGU	✓		0.500" - 0.625"	Screw-on clamping with offset	B193
	JPVJ2XR/L Cutting edge angle 93° Insert type: VXGU	✓		0.375" - 0.625"	Side clamping without offset	B194
	JSVJ2XR/L-CHP Cutting edge angle 93° Insert type: VXGU	✓		0.500"	Screw-on clamping without offset	B195
	JSVJ2XR/L Cutting edge angle 93° Insert type: VXGU	✓		0.375" - 0.625"	Screw-on clamping without offset	B194
	JSVJ2BR/L Cutting edge angle 93° Insert type: VB□□	✓		0.375" - 0.625"	Screw-on clamping without offset	B371
	JSVJ2BR/L-CHP Cutting edge angle 93° Insert type: VB□□	✓		0.500"	Screw-on clamping without offset	B372
	JSVJXR-F Cutting edge angle 93° Insert type: VXGU	✓		0.500" - 0.625"	Screw-on clamping with offset	B195
	JS-SDUXL Cutting edge angle 93° Insert type: DXGU	✓		ø0.625" - 1.000"	Screw-on clamping with offset	B196
	JS-SVUXL Cutting edge angle 93° Insert type: VXGU	✓		ø0.625" - 1.000"	Screw-on clamping with offset	B197



Miniature Tool

Miniature External Turning - Quick Guide

External Turning & Profiling

Metric

Style	Description	Type of insert		Shank Size	Clamping style	See page
		Positive	Negative			
	JPDJ2XR/L Cutting edge angle 93° Insert type: DXGU	✓		10 - 16 mm	Side clamping without offset	B192
	JSDJ2XR/L Cutting edge angle 93° Insert type: DXGU	✓		10 - 20 mm	Screw-on clamping without offset	B192
	JSDJ2XR/L-CHP Cutting edge angle 93° Insert type: DXGU	✓		12 mm	Screw-on clamping without offset	B193
	JTDJ2CR/L Cutting edge angle 93° Insert type: DC□□	✓		10 - 16 mm	Back side clamping without offset	B366
	JSDJ2CR/L Cutting edge angle 93° Insert type: DC□□	✓		8 - 16 mm	Screw-on clamping without offset	B365
	JSDJ2CR/L-CHP Cutting edge angle 93° Insert type: DC□□	✓		12 mm	Screw-on clamping without offset	B367
	JSDJCR/L Cutting edge angle 93° Insert type: DC□□	✓		8 - 16 mm	Screw-on clamping with offset	B367
	JSDNCN Cutting edge angle 62.5° Insert type: DC□□	✓		10 - 16 mm	Screw-on clamping with offset	B368
	JSDN3CR/L Cutting edge angle 62.5° Insert type: DC□□	✓		12 - 16 mm	Screw-on clamping with offset	B368
	JSDJXR-F Cutting edge angle 93° Insert type: DXGU	✓		10 - 16 mm	Screw-on clamping with offset	B193
	JPVJ2XR/L Cutting edge angle 93° Insert type: VXGU	✓		10 - 16 mm	Side clamping without offset	B194
	JSVJ2XR/L-CHP Cutting edge angle 93° Insert type: VXGU	✓		12 mm	Screw-on clamping without offset	B195
	JSVJ2XR/L Cutting edge angle 93° Insert type: VXGU	✓		10 - 20 mm	Screw-on clamping without offset	B194
	JSVJ2BR/L Cutting edge angle 93° Insert type: VB□□	✓		10 - 16 mm	Screw-on clamping without offset	B371
	JSVJ2BR/L-CHP Cutting edge angle 93° Insert type: VB□□	✓		12 mm	Screw-on clamping without offset	B372
	JSVABR/L Cutting edge angle 91° Insert type: VB□□	✓		10 - 16 mm	Screw-on clamping without offset	B372
	JSVP2PR/L Cutting edge angle 117.5° Insert type: VP□□	✓		10 - 16 mm	Screw-on clamping without offset	B375



Miniature Tool

External Turning & Profiling

Metric

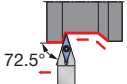
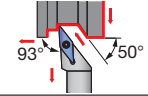
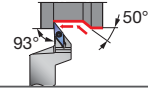
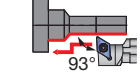
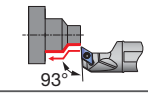
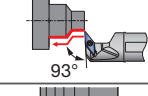
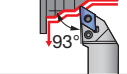
Style	Description	Type of insert		Shank Size	Clamping style	See page
		Positive	Negative			
	JSVNBN Cutting edge angle 72.5° Insert type: VB□□	✓		10 - 16 mm	Screw-on clamping with offset	B374
	JSVJBR/L Cutting edge angle 93° Insert type: VB□□	✓		10 - 16 mm	Screw-on clamping with offset	B371
	JSVJXR-F Cutting edge angle 93° Insert type: VXGU	✓		10 - 16 mm	Screw-on clamping with offset	B195
	JS-SDUCL Cutting edge angle 93° Insert type: DC□□	✓		ø19.05 - 25.4 mm	Screw-on clamping with offset	B369
	JS-SDUXL Cutting edge angle 93° Insert type: DXGU	✓		ø14 - 25.4 mm	Screw-on clamping with offset	B196
	JS-SVUXL Cutting edge angle 93° Insert type: VXGU	✓		ø15.875 - 25.4 mm	Screw-on clamping with offset	B197
	PDJNR Cutting edge angle 93° Insert type: DN□□		✓	20 mm	Lever-lock clamping with offset	B376



Miniature Tool

Miniature Internal Turning - Quick Guide

Positive type Inch

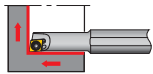
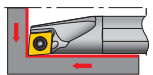
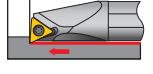
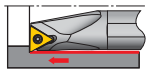
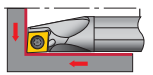
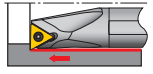
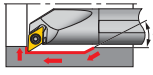
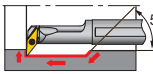
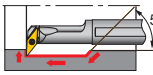
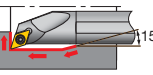
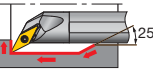
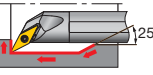
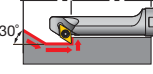
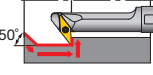
Style	StreamJet-Bar Description & Application	ISO Insert	Y-Pro	Shank Type	Shank Ø	Min. bore diameter (in)					See page
						0	0.375	0.750	1.125	1.500	
	SEXPR/L Boring & Internal facing Insert type: EP□□	✓		Steel	ø0.313	ø0.250					B302
				Carbide	ø0.313	ø0.250					
	SCLCR/L Boring & internal facing Insert type: CC□□	✓		Steel	ø0.375 - ø1.000	ø0.500		ø1.250			B299
				Carbide	ø0.375 - ø1.000	ø0.500		ø1.250			
	STUPR/L Boring Insert type: TP□□	✓		Steel	ø0.313 - ø1.000	ø0.438		ø1.250			B310
				Carbide	ø0.313 - ø0.625	ø0.438		ø0.875			
	STFPR/L Blind hole boring Insert type: TP□□	✓		Carbide	ø0.375 - ø0.750	ø0.500		ø1.000			B309
	SCLPR/L Boring & internal facing Insert type: CP□□	✓		Steel	ø0.375 - ø0.625	ø0.500		ø0.875			B303
				Carbide	ø0.375 - ø0.625	ø0.500		ø0.875			
	STFCR/L Blind hole boring Insert type: TC□□	✓		Carbide	ø0.375 - ø0.750	ø0.430		ø0.930			B308
	SDUCR/L Boring & internal profiling Insert type: DC□□	✓		Steel	ø0.375 - ø0.750	ø0.625		ø1.000			B313
				Carbide	ø0.375 - ø0.750	ø0.625		ø1.000			
	SVUCR/L Boring & internal profiling Insert type: VC□□	✓		Steel	ø0.625 - ø0.750	ø0.875		ø1.000			B315
	SVUBR/L Boring & internal profiling Insert type: VB□□	✓		Steel	ø0.750	ø1.000					B314
	SDQCR/L Boring & internal profiling Insert type: DC□□	✓		Steel	ø0.375 - ø0.625	ø0.625		ø0.875			B316
	SVQCR/L Boring & internal profiling Insert type: VC□□	✓		Steel	ø0.500 - ø0.625	ø0.688		ø1.000			B318
	SVQBR/L Boring & internal profiling Insert type: VB□□	✓		Steel	ø0.625	ø1.000					B317
	SDZCR/L Internal retracting Insert type: DC□□	✓		Steel	ø0.625	ø0.875					B319
	SVZCR/L Internal retracting Insert type: VC□□	✓		Steel	ø0.500 - ø0.750	ø0.750		ø1.000			B320

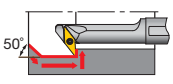
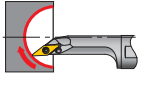
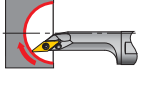
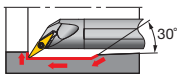
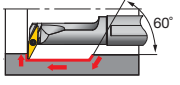



Style	StreamJet-Bar Description & Application	ISO Insert	Y-Pro	Shank Type	Shank Ø	Min. bore diameter (in)						See page
						0	0.375	0.750	1.125	1.500	2.000	
	SVZBR/L Internal retracting Insert type: VB□□	✓		Steel	ø0.750						ø1.000	B320
	SVJCR/L Internal sphere cutting Insert type: VC□□	✓		Steel	ø0.625						ø1.000	B306
	SVJBR/L Internal sphere cutting Insert type: VB□□	✓		Steel	ø0.625						ø1.000	B306
	SYQBR/L Internal undercut & profiling Insert type: YW□□		✓	Steel Carbide	ø0.500 - ø0.625 ø0.500 - ø0.625	ø0.750		ø0.875				B329
	SYUBR/L Boring & internal profiling Insert type: YW□□		✓	Steel Carbide	ø0.625 ø0.500 - ø0.625			ø0.875		ø1.000	ø1.000	B329

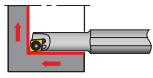
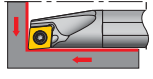
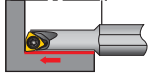
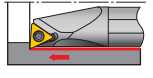
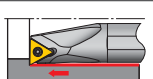
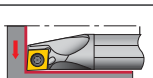
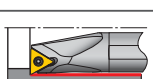
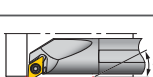
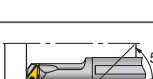

Miniature Tool

Miniature Internal Turning - Quick Guide

Positive type Metric

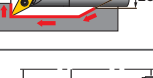
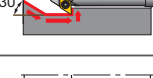
Style	StreamJet-Bar Description & Application	ISO Insert	Y-Pro	Shank Type	Shank Ø	Min. bore diameter (mm)					See page	
						0	10	20	30	40		50
	SEXPR/L Boring & Internal facing Insert type: EP□□	✓		Steel	ø4 - ø8	ø4.5	ø7					B302
	SCLCR/L Boring & internal facing Insert type: CC□□	✓		Steel	ø4 - ø25	ø5			ø27			B300
	SWUBR/L Boring Insert type: WB□□	✓		Steel	ø5 - ø8	ø6	ø8					B312
	STUPR/L Boring Insert type: TP□□	✓		Steel	ø7 - ø32	ø8			ø34			B311
	STFPR/L Blind hole boring Insert type: TP□□	✓		Steel	ø8 - ø25	ø10			ø27			B309
	SCLPR/L Boring & internal facing Insert type: CP□□	✓		Steel	ø8 - ø25	ø10			ø27			B304
	STFCR/L Blind hole boring Insert type: TC□□	✓		Steel	ø10 - ø16	ø12	ø18					B308
	SDUCR/L Boring & internal profiling Insert type: DC□□	✓		Steel	ø10 - ø25	ø13			ø32			B313
	SVUCR/L Boring & internal profiling Insert type: VC□□	✓		Steel	ø12 - ø25	ø16			ø32			B315
	SVUBR/L Boring & internal profiling Insert type: VB□□	✓		Steel	ø16 - ø25		ø20		ø32			B314
	SDQCR/L Boring & internal profiling Insert type: DC□□	✓		Steel	ø10 - ø25	ø13			ø30			B316
	SVQCR/L Boring & internal profiling Insert type: VC□□	✓		Steel	ø10 - ø16	ø13.5			ø21.5			B318
	SVQBR/L Boring & internal profiling Insert type: VB□□	✓		Steel	ø12 - ø25		ø17		ø30.5			B317
	SDZCR/L Internal retracting Insert type: DC□□	✓		Steel	ø12 - ø25	ø14			ø25			B319
	SVZCR/L Internal retracting Insert type: VC□□	✓		Steel	ø12		ø16					B320

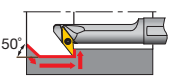
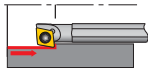
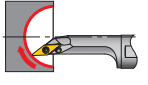
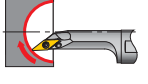
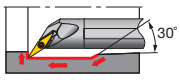
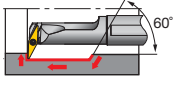
Style	StreamJet-Bar Description & Application	ISO Insert	Y-Pro	Shank Type	Shank Ø	Min. bore diameter (mm)						See page
						0	10	20	30	40	50	
	SVZBR/L Internal retracting Insert type: VB□□	✓		Steel	Ø16 - Ø32			Ø20			Ø40	B320
	SEZPR/L Internal retracting Insert type: EP□□	✓		Steel	Ø4 - Ø5	Ø5.5		Ø6.5				B321
	SVJCR/L Internal sphere cutting Insert type: VC□□	✓		Steel	Ø12 - Ø16			Ø16			Ø20	B306
	SVJBR/L Internal sphere cutting Insert type: VB□□	✓		Steel	Ø20 - Ø25			Ø25			Ø30	B306
	SYQBR/L Internal undercut & profiling Insert type: YW□□		✓	Steel	Ø12 - Ø16			Ø17			Ø21.5	B329
	SYUBR/L Boring & internal profiling Insert type: YW□□		✓	Steel	Ø16			Ø20				B329
				Carbide	Ø12 - Ø16			Ø20			Ø24.5	



Miniature Tool

Miniature Internal Turning - Quick Guide

Double-sided insert with positive cutting edges

Inch

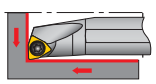
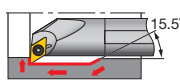
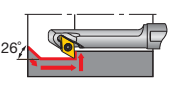
Style	MiniForce-Turn Description & Application	MiniForce -Turn	Shank Type	Shank Ø	Min. bore diameter (in)						See page	
					0	0.375	0.750	1.125	1.500	2.000		
	SWLXR/L Boring & facing Insert type: WXGU	✓		Steel	Ø0.375 - Ø0.750			Ø0.500			Ø1.000	B288
	SDXXR/L Internal profiling Insert type: DXGU	✓		Steel	Ø0.375 - Ø0.750			Ø0.625			Ø1.000	B288
	SDZXR/L Internal retracting Insert type: DXGU	✓		Steel	Ø0.500 - Ø0.750			Ø0.625			Ø0.875	B289

Miniature Internal Turning - Quick Guide

TinyMini-Turn - Solid carbide tools for small diameters turning

Metric

Boring, profiling, chamfering

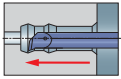
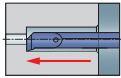
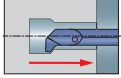
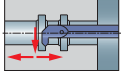
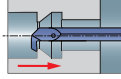
Style	TinyMini-Turn Description & Application	Shank øDs (mm)	Min. bore diameter øDm (mm)						See page
			0	2	4	6	8	10	
	JBT Boring, profiling, & chamfering	ø4 & ø7	ø0.6	ø7				B386	
	JBP Boring & chamfering	ø4 & ø7	ø2.8	ø5				B387	
	JBU Back boring & chamfering	ø7		ø5				B387	
	JBC Boring & 45° chamfering	ø7		ø5 ø6.8				B387	
	JBB Back boring	ø4 & ø7	ø3	ø7				B388	

Threading

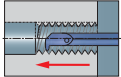
Style	TinyMini-Turn Description & Application	Shank øDs (mm)	Min. bore diameter øDm (mm)						See page
			0	2	4	6	8	10	
	JBI Threading (Metric thread)	ø4 & ø7		ø4 ø7				B388	

Grooving

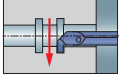
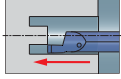
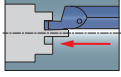
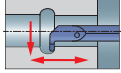
Style	TinyMini-Turn Description & Application	Shank øDs (mm)	Groove width (mm)	Min. bore diameter øDm (mm)						See page
				0	2	4	6	8	10	
	JBG Grooving	ø4 & ø7	0.5 - 2	ø2	ø6.8				B389	
	JBF Face grooving	ø7	1 - 3		ø6 ø15				B390	
	JBS Face grooving (for shaft)	ø7	2		ø6				B390	
	JBR Boring & profiling (full radius type)	ø7	1	ø5	ø6.8				B391	



Miniature Tool

MEMO

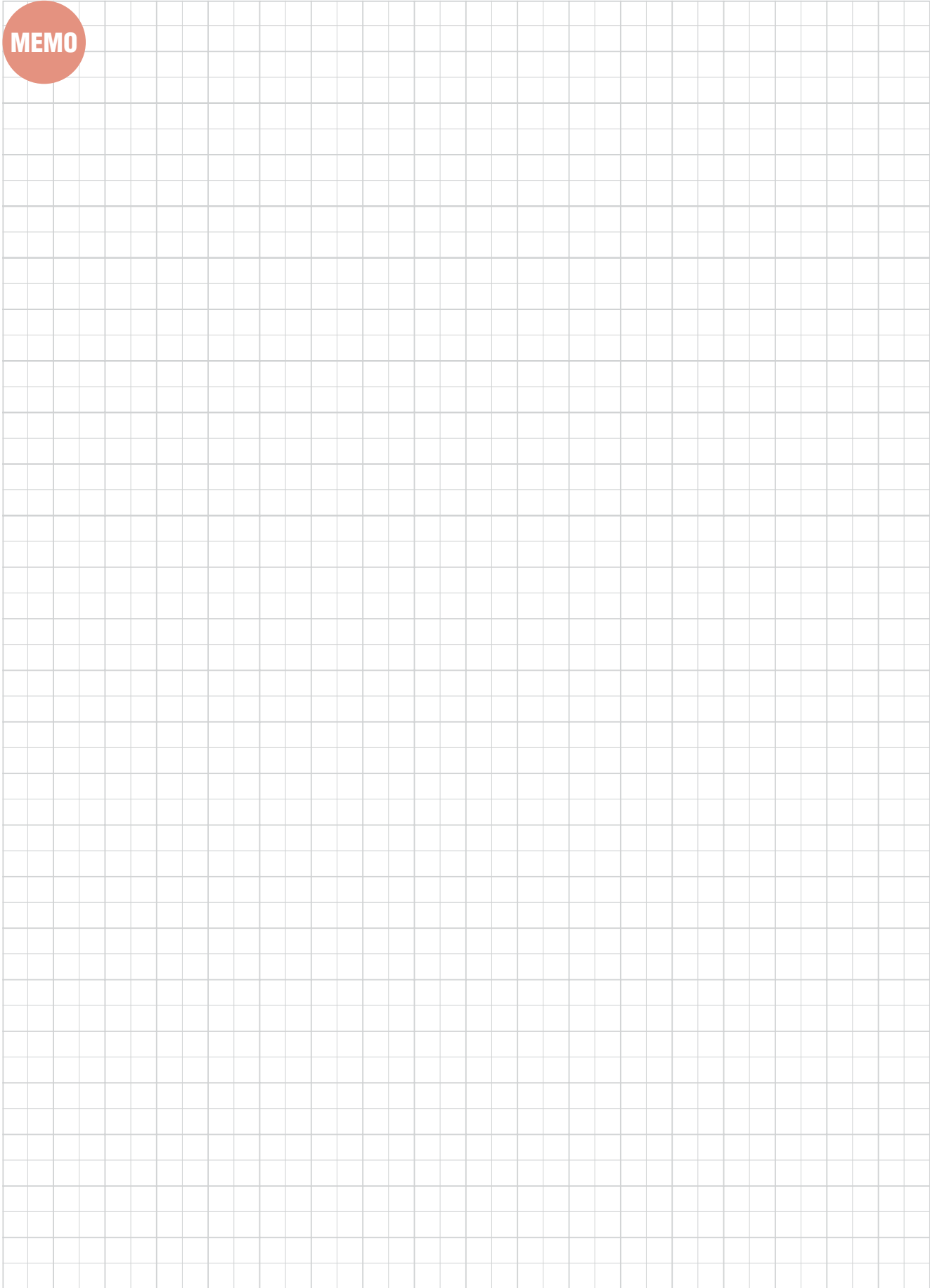

Miniature Tool

J-SERIES

JSCL2CR/L

Screw-on toolholder without offset with 95° approach angle for positive 80° rhombic inserts

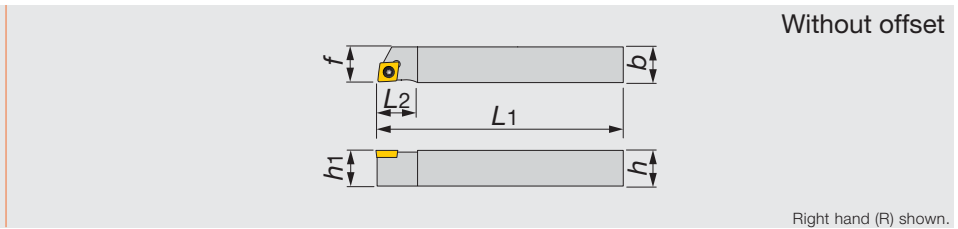
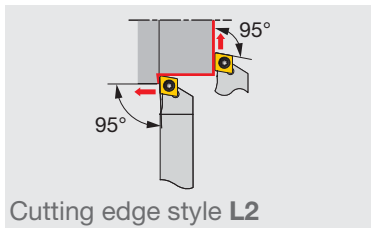

Inch	h	b	L1	L2	h1	f	r _ε **	Insert	Torque*
JSCL2CR/L062	0.375	0.375	5.000	0.400	0.375	0.375	0.016	CC**21.5...	0.89
JSCL2CR/L082	0.500	0.500	5.000	0.400	0.500	0.500	0.016	CC**21.5...	0.89
JSCL2CR/L103	0.625	0.625	5.000	0.680	0.625	0.625	0.031	CC**32.5...	0.89

Metric	h	b	L1	L2	h1	f	r _ε **	Insert	Torque
JSCL2CR/L1010K06	10	10	120	12	10	10	0.4	CC**0602...	1.2
JSCL2CR/L1212K06	12	12	85	12	12	12	0.4	CC**0602...	1.2
JSCL2CR/L1212X06	12	12	120	12	12	12	0.4	CC**0602...	1.2
JSCL2CL1212K06	12	12	125	12	12	12	0.4	CC**0602...	1.2
JSCL2CR/L1212F09	12	12	85	16	12	12	0.8	CC**09T3...	1.2
JSCL2CR/L1212X09	12	12	120	16	12	12	0.8	CC**09T3...	1.2
JSCL2CR/L1616X09	16	16	120	16	16	16	0.8	CC**09T3...	1.2

*Torque: Recommended torque (lbf-ft, N-m) for clamping
 **re: Standard corner radius

Miniature Tool

SPARE PARTS

Designation	Clamping screw	Wrench
JSCL2CR/L...	CSTB-2.5	T-8F

J-SERIES

JTCL2CR/L

Back clamp toolholder without offset with 95° approach angle for positive 80° rhombic inserts

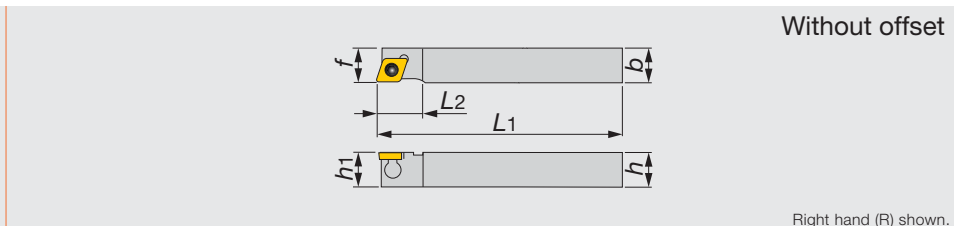
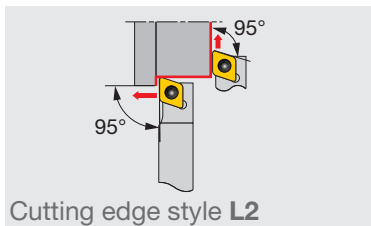

Metric	h	b	L1	L2	h1	f	r _ε **	Insert	Torque*
JTCL2CL0810K06	8	10	125	12	8	10	0.4	CC**0602...	0.9
JTCL2CR/L1010X06	10	10	120	12	10	10	0.4	CC**0602...	0.9
JTCL2CR/L1212F09	12	12	85	16	12	12	0.8	CC**09T3...	1.2
JTCL2CR/L1212X09	12	12	120	16	12	12	0.8	CC**09T3...	1.2
JTCL2CR/L1616X09	16	16	120	16	16	16	0.8	CC**09T3...	1.2
JTCL2CR1616M09	16	16	150	16	16	16	0.8	CC**09T3...	1.2

*Torque: Recommended torque (N-m) for clamping
 **re: Standard corner radius

SPARE PARTS

Designation	Clamp	Clamping screw	Wrench
JTCL2CR/L**06	JCP-2	JDS-3525	P-2F
JTCL2CR/L**09	JCP-3	JDS-5040	P-2.5F

Reference pages

JSCL2CR/L, JTCL2CR/L: Inserts → B106 -, CBN → B170 -, PCD → B179

J-SERIES

JSCLCR/L

Screw-on toolholder with 95° approach angle for positive 80° rhombic inserts

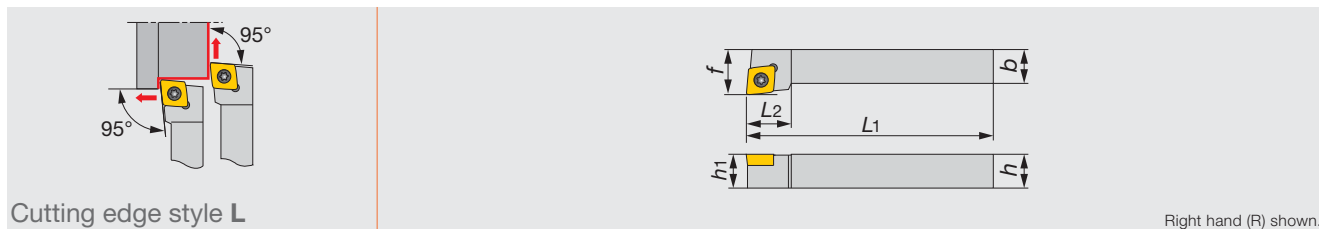

Metric	<i>h</i>	<i>b</i>	<i>L</i> ₁	<i>L</i> ₂	<i>h</i> ₁	<i>f</i>	<i>r</i> _c **	Insert	Torque*
JSCLCR/L0808H06	8	8	100	12	8	10	0.4	CC**0602...	1.2
JSCLCR/L1010H06	10	10	100	12	10	12	0.4	CC**0602...	1.2
JSCLCR/L1212H09	12	12	100	16	12	16	0.8	CC**09T3...	1.2
JSCLCR/L1616H09	16	16	100	16	16	20	0.8	CC**09T3...	1.2

*Torque: Recommended torque (N-m) for clamping
 ***r*_c: Standard corner radius

SPARE PARTS

Designation	Clamping screw	Wrench
JSCLCR/L**H06	CSTB-2.5	T-8F
JSCLCR/L**H09	CSTB-4SD	T-8F

J-SERIES

JSCLCR-F

Screw-on stepped-head toolholder with 95° approach angle for positive 80° rhombic inserts

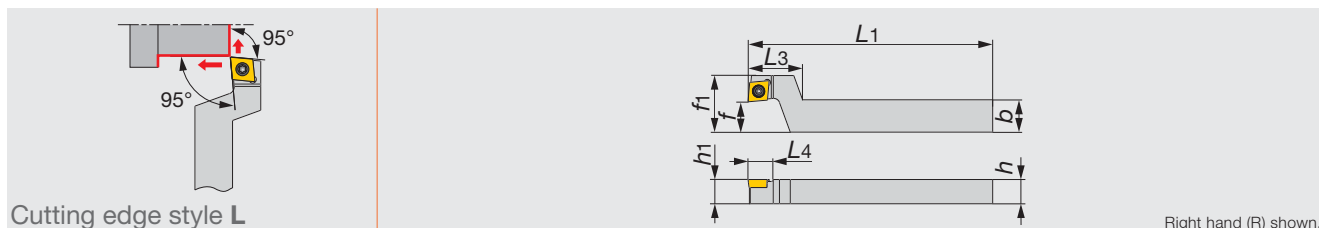

Metric	<i>h</i>	<i>b</i>	<i>L</i> ₁	<i>L</i> ₂	<i>L</i> ₃	<i>L</i> ₄	<i>h</i> ₁	<i>f</i>	<i>f</i> ₁	<i>r</i> _c **	Insert	Torque*
JSCLCR1216F09-F15	12	16	85	12	27	12.5	12	15	28	0.2	CC**09T3...	1.2
JSCLCR1216X09-F15	12	16	120	12	27	12.5	12	15	28	0.2	CC**09T3...	1.2
JSCLCR1620X09-F15	16	20	120	12	27	12.5	16	15	28	0.2	CC**09T3...	1.2

*Torque: Recommended torque (N-m) for clamping
 ***r*_c: Standard corner radius

SPARE PARTS

Designation	Clamping screw	Wrench
JSCLCR**F15	CSTB-4SD	T-8F

Reference pages

JSCLCR/L, JSCLCR-F: Inserts → B106 -, CBN → B170 -, PCD → B179



Miniature Tool

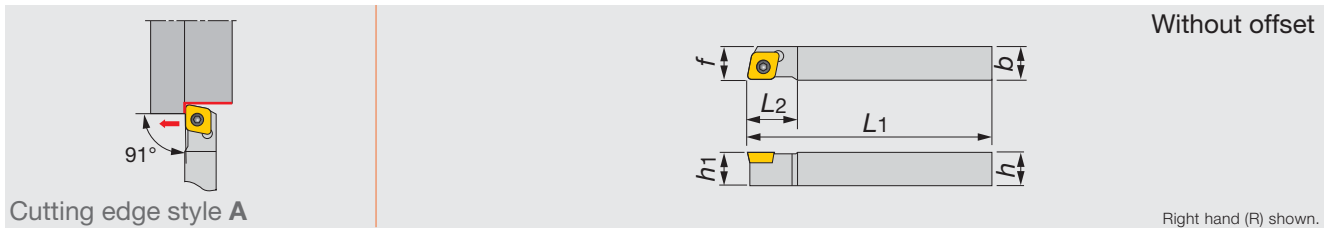

Metric	<i>h</i>	<i>b</i>	<i>L</i> ₁	<i>L</i> ₂	<i>h</i> ₁	<i>f</i>	<i>r</i> _c **	Insert	Torque*
JSCACL1010H06	10	10	100	12	10	10	0.4	CC**0602...	1.2
JSCACL1212H09	12	12	100	16	12	12	0.8	CC**09T3...	1.2

*Torque: Recommended torque (N-m) for clamping

***r*_c: Standard corner radius



Miniature Tool

SPARE PARTS



Designation	Clamping screw	Wrench
JSCACL1010H06	CSTB-2.5	T-8F
JSCACL1212H09	CSTB-4SD	T-8F

Reference pages

JSCACL: Inserts → **B106** -, CBN → **B170** -, PCD → **B179**

J-SERIES

JSCGCR/L

Screw-on toolholder with 91° approach angle for positive 80° rhombic inserts

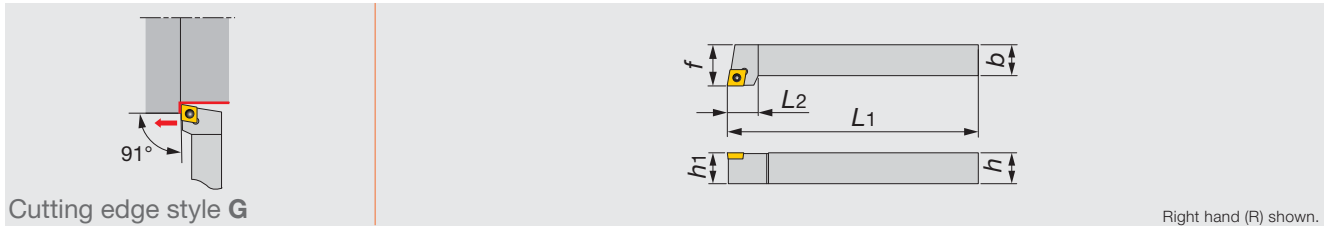

Metric	h	b	L1	L2	h1	f	rε**	Insert	Torque*
JSCGCR/L1212H06	12	12	100	12	12	16	0.4	CC**0602...	1.2
JSCGCR/L1616H09	16	16	100	16	16	20	0.8	CC**09T3...	1.2

*Torque: Recommended torque (N-m) for clamping
 **re: Standard corner radius

SPARE PARTS

Designation	Clamping screw	Wrench
JSCGCR/L1212H06	CSTB-2.5	T-8F
JSCGCR/L1616H09	CSTB-4SD	T-8F

J-SERIES

JSDJ2CR/L

Screw-on toolholder without offset with 93° approach angle for positive 55° rhombic inserts

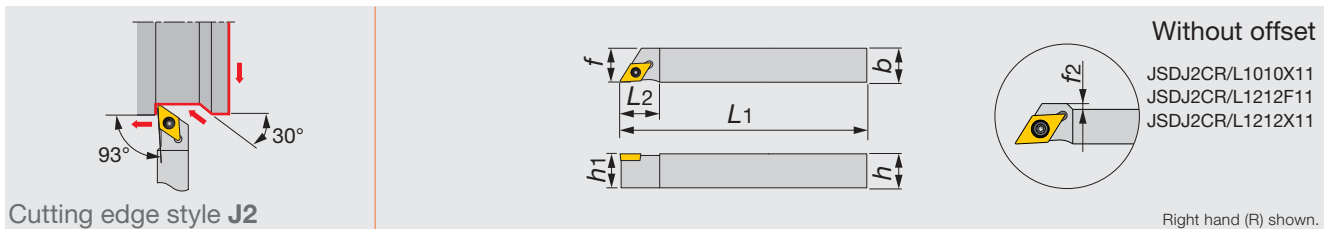

Inch	h	b	L1	L2	h1	f	f2	rε**	Insert	Torque*
JSDJ2CR/L062	0.375	0.375	5.000	0.500	0.375	0.375	-	0.016	DC**21.5...	0.89
JSDJ2CR/L082	0.500	0.500	5.000	0.500	0.500	0.500	-	0.016	DC**21.5...	0.89
JSDJ2CR/L103	0.625	0.625	5.000	0.780	0.625	0.625	-	0.031	DC**32.5...	0.89

Metric	h	b	L1	L2	h1	f	f2	rε**	Insert	Torque*
JSDJ2CR/L0808F07	8	8	85	14	8	8	-	0.4	DC**0702...	1.2
JSDJ2CR/L1010X07	10	10	120	14	10	10	-	0.4	DC**0702...	1.2
JSDJ2CR/L1010X11	10	10	120	20	10	10	4	0.8	DC**11T3...	1.2
JSDJ2CR/L1212F07	12	12	85	14	12	12	-	0.4	DC**0702...	1.2
JSDJ2CR/L1212F11	12	12	85	20	12	12	2	0.8	DC**11T3...	1.2
JSDJ2CR/L1212X07	12	12	120	14	12	12	-	0.4	DC**0702...	1.2
JSDJ2CL1212K07	12	12	125	14	12	12	-	0.4	DC**0702...	1.2
JSDJ2CR/L1212X11	12	12	120	20	12	12	2	0.8	DC**11T3...	1.2
JSDJ2CR/L1616X11	16	16	120	20	16	16	-	0.8	DC**11T3...	1.2

*Torque: Recommended torque (lbf-ft, N-m) for clamping
 **re: Standard corner radius

SPARE PARTS

Designation	Clamping screw	Wrench
JSDJ2CR/L062/082, JSDJ2CR/L**07	CSTB-2.5	T-8F
JSDJ2CR/L103, JSDJ2CR/L**11	CSTB-4SD	T-8F

Reference pages

JSCGCR/L: Inserts → B106 -, CBN → B170 -, PCD → B179

JSDJ2CR/L: Inserts → B116 -, CBN → B170 -, PCD → B179

Miniature Tool

J-SERIES

JTDJ2CR/L

Back clamp toolholder without offset with 93° approach angle for positive 55° rhombic inserts

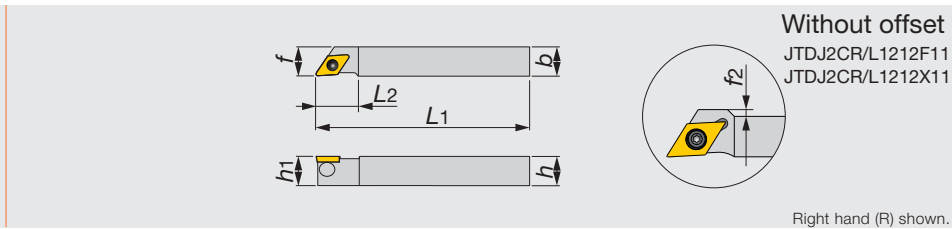
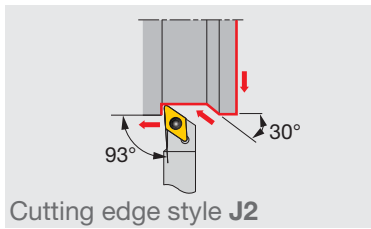

Metric	h	b	L1	L2	h1	f	f2	rε**	Insert	Torque*
JTDJ2CR/L1010X07	10	10	120	14	10	10	-	0.4	DC**0702...	0.9
JTDJ2CR/L1212F07	12	12	85	14	12	12	-	0.4	DC**0702...	0.9
JTDJ2CR/L1212X07	12	12	120	14	12	12	-	0.4	DC**0702...	0.9
JTDJ2CR/L1212F11	12	12	85	20	12	12	2	0.8	DC**11T3...	1.2
JTDJ2CR/L1212X11	12	12	120	20	12	12	2	0.8	DC**11T3...	1.2
JTDJ2CL1212M11	12	12	150	20	12	12	-	0.8	DC**11T3...	1.2
JTDJ2CR/L1616X11	16	16	120	20	16	16	-	0.8	DC**11T3...	1.2

*Torque: Recommended torque (N-m) for clamping
 **re: Standard corner radius

SPARE PARTS

Designation	Clamp	Clamping screw	Wrench
JTDJ2CR/L**07	JCP-2	JDS-3525	P-2F
JTDJ2CR/L**11	JCP-3	JDS-5040	P-2.5F



Miniature Tool

J-SERIES

JSDJCR-F

Screw-on stepped-head toolholder with 93° approach angle for positive 55° rhombic inserts

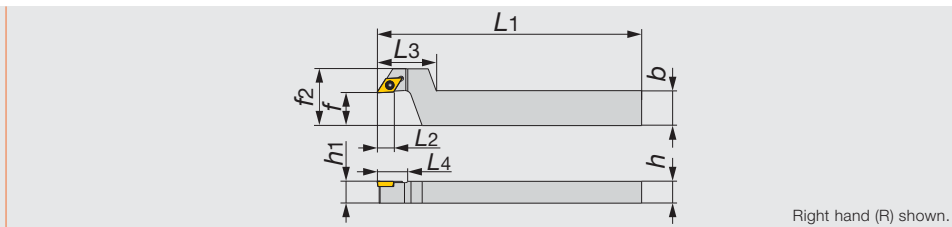
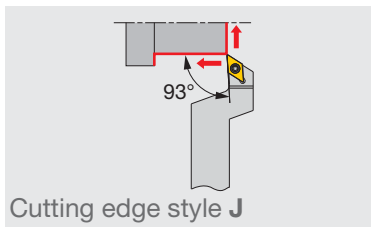

Metric	h	b	L1	L2	L3	L4	h1	f	f2	rε**	Insert	Torque*
JSDJCR1016X07-F15	10	16	120	12.5	27	14	10	15	26	0.4	DC**0702...	1.2
JSDJCR1216F07-F15	12	16	85	12.5	27	14	12	15	26	0.4	DC**0702...	1.2
JSDJCR1216X07-F15	12	16	120	12.5	27	14	12	15	26	0.4	DC**0702...	1.2
JSDJCR1216F11-F15	12	16	85	12.5	27	20	12	15	28	0.8	DC**11T3...	1.2
JSDJCR1216X11-F15	12	16	120	12.5	27	20	12	15	28	0.8	DC**11T3...	1.2
JSDJCR1620X11-F15	16	20	120	12.5	27	20	16	15	28	0.8	DC**11T3...	1.2

*Torque: Recommended torque (N-m) for clamping
 **re: Standard corner radius

SPARE PARTS

Designation	Clamping screw	Wrench
JSDJCR**07-F15	CSTB-2.5	T-8F
JSDJCR**11-F15	CSTB-4SD	T-8F

Reference pages

JTDJ2CR/L, JSDJCR-F: Inserts → B116 -, CBN → B170 -, PCD → B179

J-SERIES

JSDJ2CR/L-CHP

Screw-on toolholder without offset with 93° approach angle for positive 55° rhombic inserts, with channels for high pressure coolant

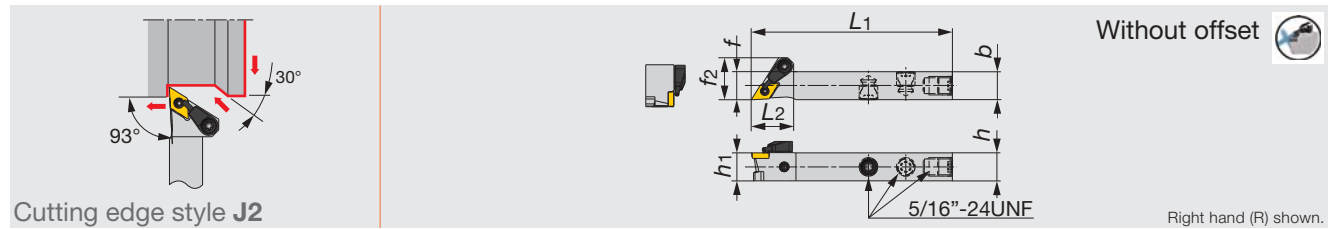

Inch	<i>h</i>	<i>b</i>	<i>L</i> ₁	<i>L</i> ₂	<i>h</i> ₁	<i>f</i>	<i>f</i> ₂	<i>r</i> _ε **	Insert	Torque*
JSDJ2CR/L082-CHP	0.500	0.500	3.344	0.710	0.500	0.500	0.710	0.008	DC**21.5...	0.7

Metric	<i>h</i>	<i>b</i>	<i>L</i> ₁	<i>L</i> ₂	<i>h</i> ₁	<i>f</i>	<i>f</i> ₂	<i>r</i> _ε **	Insert	Torque*
JSDJ2CR/L1212F07-CHP	12	12	85	18	12	12	18	0.4	DC**0702...	1.2
JSDJ2CR/L1212F11-CHP	12	12	85	19	12	12	20.5	0.8	DC**11T3...	1.2

*Torque: Recommended torque (lbf-ft, N-m) for clamping
 **re: Standard corner radius

SPARE PARTS

Designation	Clamping screw	Coolant unit	Wrench
JSDJ2CR/L082-CHP, JSDJ2CR/L1212F07-CHP	CSTB-2.5	S-CU-CHP	T-8F
JSDJ2CR/L1212F11-CHP	CSTB-4SD	S-CU-CHP	T-8F

J-SERIES

JSDJCR/L

Screw-on toolholder with 93° approach angle for positive 55° rhombic inserts

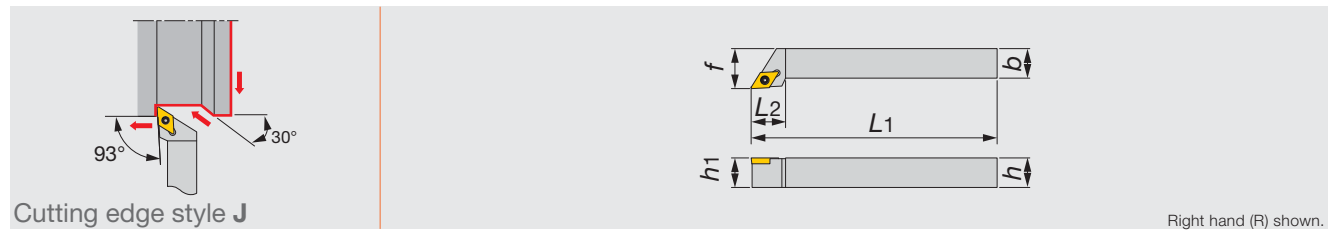

Metric	<i>h</i>	<i>b</i>	<i>L</i> ₁	<i>L</i> ₂	<i>h</i> ₁	<i>f</i>	<i>r</i> _ε **	Insert	Torque*
JSDJCR/L0808H07	8	8	100	14	8	10	0.4	DC**0702...	1.2
JSDJCR/L1010H11	10	10	100	18	10	12	0.8	DC**11T3...	1.2
JSDJCR/L1212H07	12	12	100	14	12	16	0.4	DC**0702...	1.2
JSDJCR/L1212H11	12	12	100	18	12	16	0.8	DC**11T3...	1.2
JSDJCR/L1616H11	16	16	100	18	16	20	0.8	DC**11T3...	1.2

*Torque: Recommended torque (N-m) for clamping
 **re: Standard corner radius

SPARE PARTS

Designation	Clamping screw	Wrench
JSDJC**H07	CSTB-2.5	T-8F
JSDJC**H11	CSTB-4SD	T-8F

Reference pages

JSDJ2CR/L-CHP, JSDJCR/L: Inserts → B116 -, CBN → B170 -, PCD → B179

Miniature Tool

J-SERIES

JSDNCN

Screw-on toolholder with 62.5° approach angle for positive 55° rhombic inserts

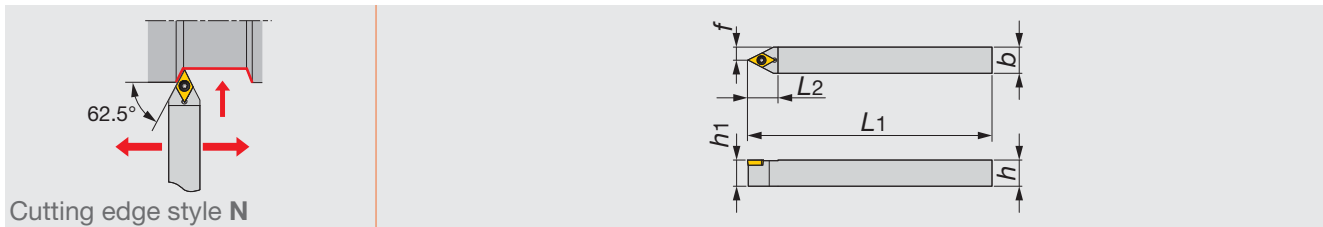

Cutting edge style N

Inch	h	b	L1	L2	h1	f	re**	Insert	Torque*
JSDNCN062	0.375	0.375	5.000	0.550	0.375	0.375	0.016	DC**21.5...	0.89
JSDNCN082	0.500	0.500	5.000	0.550	0.500	0.500	0.016	DC**21.5...	0.89
JSDNCN103	0.625	0.625	5.000	0.826	0.625	0.625	0.031	DC**32.5...	0.89

Metric	h	b	L1	L2	h1	f	re**	Insert	Torque*
JSDNCN1010X07	10	10	120	15	10	5	0.4	DC**0702...	1.2
JSDNCN1010X11	10	10	120	21	10	5	0.8	DC**11T3...	1.2
JSDNCN1212F07	12	12	85	15	12	6	0.4	DC**0702...	1.2
JSDNCN1212X07	12	12	120	15	12	6	0.4	DC**0702...	1.2
JSDNCN1212F11	12	12	85	21	12	6	0.8	DC**11T3...	1.2
JSDNCN1212H11	12	12	100	21	12	6	0.8	DC**11T3...	1.2
JSDNCN1212X11	12	12	120	21	12	6	0.8	DC**11T3...	1.2
JSDNCN1616X11	16	16	120	21	16	8	0.8	DC**11T3...	1.2

*Torque: Recommended torque (lbf-ft, N-m) for clamping
 **re: Standard corner radius

SPARE PARTS

Designation	Clamping screw	Wrench
JSDNCN062/082, JSDNCN**07	CSTB-2.5	T-8F
JSDNCN103, JSDNCN**11	CSTB-4SD	T-8F

Miniature Tool

J-SERIES

JSDN3CR/L

Screw-on toolholder with 62.5° approach angle (N3-style) for positive 55° rhombic inserts

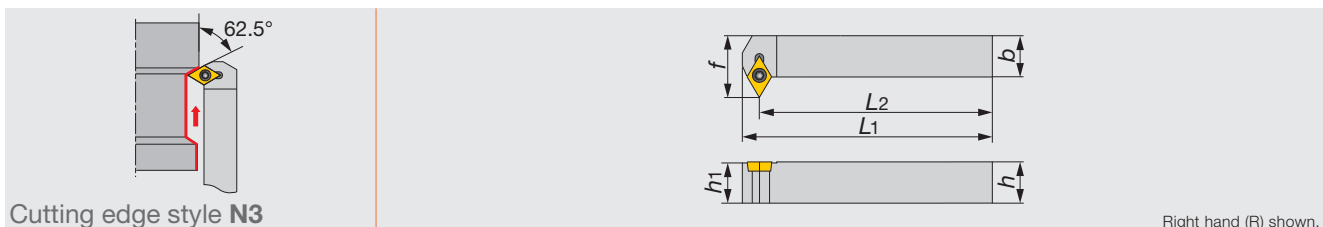

Cutting edge style N3

Right hand (R) shown.

Metric	h	b	L1	L2	h1	f	re**	Insert	Torque*
JSDN3CR1212H07	12	12	105	100	12	18	0.4	DC**0702...	1.2
JSDN3CR1616H11	16	16	107	100	16	25	0.8	DC**11T3...	1.2

*Torque: Recommended torque (N-m) for clamping
 **re: Standard corner radius

SPARE PARTS

Designation	Clamping screw	Wrench
JSDN3CR1212H07	CSTB-2.5	T-8F
JSDN3CR1616H11	CSTB-4SD	T-8F

Reference pages

JSDNCN, JSDN3CR/L: Inserts → B116 -, CBN → B170 -, PCD → B179

J-SERIES

JSDFCR/L

Screw-on toolholder for facing with 91° approach angle for positive 55° rhombic inserts

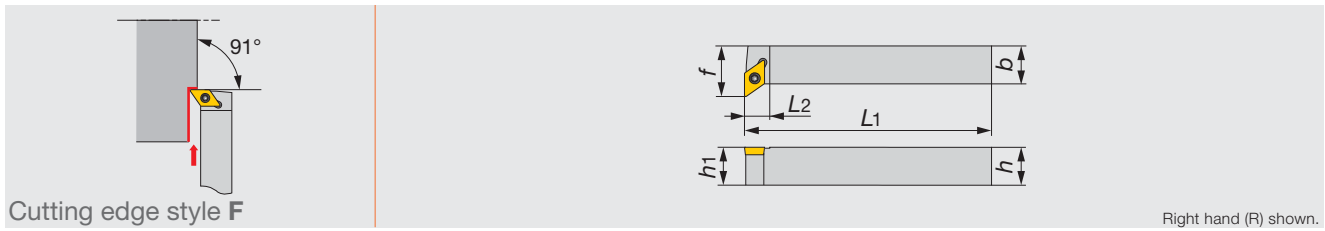

Metric	h	b	L1	L2	h1	f	re**	Insert	Torque*
JSDFCR/L1212H07	12	12	100	8	12	16	0.4	DC**0702...	1.2
JSDFCR/L1616H11	16	16	100	10.5	16	22	0.8	DC**11T3...	1.2

*Torque: Recommended torque (N-m) for clamping

**re: Standard corner radius

SPARE PARTS

Designation	Clamping screw	Wrench
JSDFCR/L1212H07	CSTB-2.5	T-8F
JSDFCR/L1616H11	CSTB-4SD	T-8F

J-SERIES

JS-SDUCL

Screw-on toolholder with 93° approach angle for positive 55° rhombic inserts

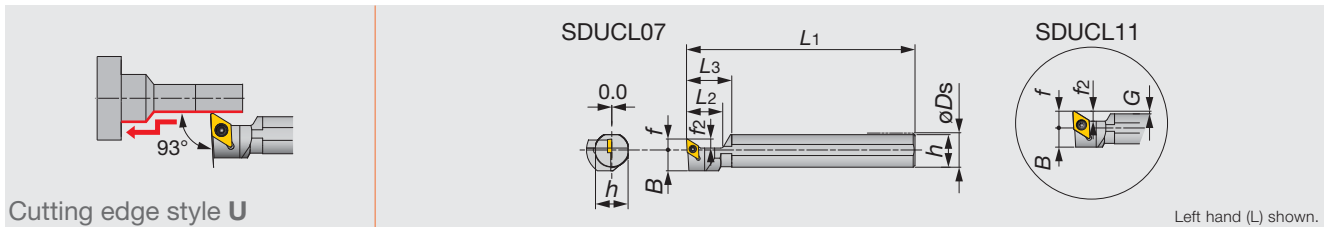

Metric	øDs	f	f2	L1	L2	L3	h	B	G	re**	Insert	Torque*
JS19K-SDUCL07	19.05	6	5	125	20	25	18	11.5	-	0.4	DC**0702...	1.2
JS20K-SDUCL07	20	6	5	125	20	25	19	11.5	-	0.4	DC**0702...	1.2
JS22K-SDUCL07	22	6	5	125	20	25	21	11.5	-	0.4	DC**0702...	1.2
JS19K-SDUCL11	19.05	10	6	125	20	25	18	11.5	1.525	0.8	DC**11T3...	1.2
JS20K-SDUCL11	20	10	6	125	20	25	19	11.5	1	0.8	DC**11T3...	1.2
JS22K-SDUCL11	22	11	6	125	20	25	21	11.5	1	0.8	DC**11T3...	1.2
JS25K-SDUCL11	25.4	12	6	125	20	25	24	12.7	0.7	0.8	DC**11T3...	1.2

*Torque: Recommended torque (N-m) for clamping

**re: Standard corner radius

SPARE PARTS

Designation	Clamping screw	Wrench
JS**K-SDUCL07	CSTB-2.5	T-8F
JS**K-SDUCL11	CSTB-4SD	T-8F

Reference pages

JSDFCR/L, JS-SDUCL: Inserts → B116 -, CBN → B170 -, PCD → B179



Miniature Tool

J-SERIES

JSTACR/L

Screw-on toolholder without offset with 91° approach angle for positive 60° triangle inserts

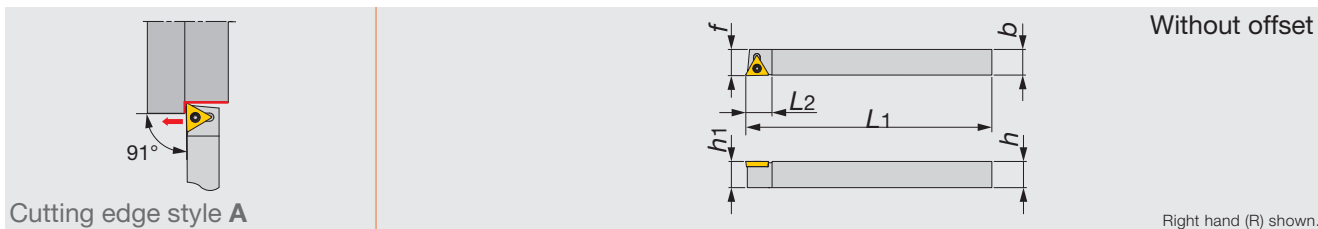

Metric	h	b	L1	L2	h1	f	r _e **	Insert	Torque*
JSTACR/L0808K08	8	8	125	10	8	8	0.2	TC**0802...	0.6
JSTACR/L1010K08	10	10	125	10	10	10	0.2	TC**0802...	0.6
JSTACR/L1212K11	12	12	125	12	12	12	0.4	TC**1102...	1.2
JSTACR/L1616H11	16	16	100	12	16	16	0.4	TC**1102...	1.2

*Torque: Recommended torque (N-m) for clamping

**r_e: Standard corner radius



Miniature Tool

SPARE PARTS

Designation	Clamping screw	Wrench
JSTACR/L**K08	CSTB-2L	T-6F
JSTACR/L**11	CSTB-2.5	T-8F

J-SERIES

JTTACR/L

Back clamp toolholder without offset with 91° approach angle for positive 60° triangle inserts

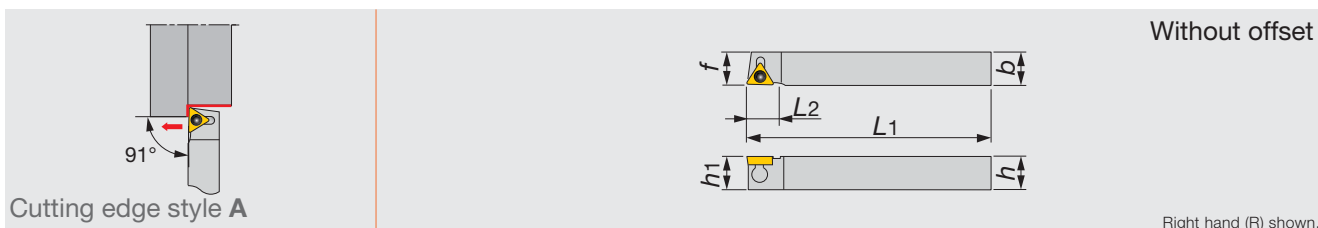

Metric	h	b	L1	L2	h1	f	r _e **	Insert	Torque*
JTTACL0810K08	8	10	125	10	8	10	0.2	TC**0802...	0.9
JTTACR/L1212M11	12	12	150	12	12	12	0.4	TC**1102...	0.9
JTTACR/L1616M11	16	16	150	12	16	16	0.4	TC**1102...	0.9

*Torque: Recommended torque (N-m) for clamping

**r_e: Standard corner radius

SPARE PARTS

Designation	Clamp	Clamping screw	Wrench
JTTACL0810K08	JCP-1	JDS-3525	P-2F
JTTACR/L**M11	JCP-2	JDS-3525	P-2F

Reference pages

JSTACR/L, JTTACR/L: Inserts → **B133** -, PCD → **B179**

J-SERIES

JSVJ2BR/L

Screw-on toolholder without offset with 93° approach angle for positive 35° rhombic inserts

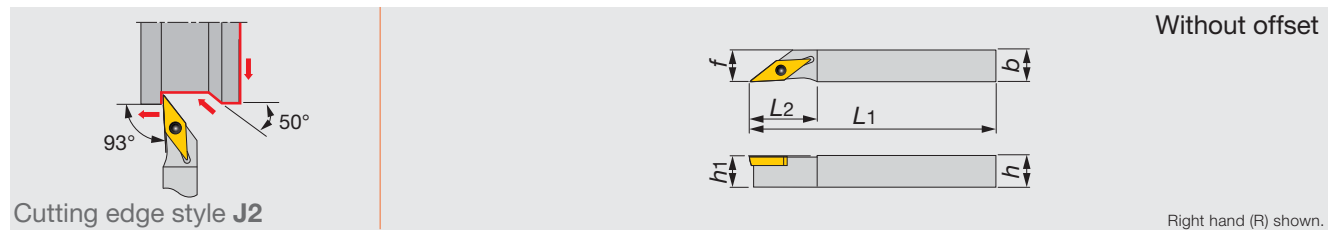

Inch	h	b	L1	L2	h1	f	rε**	Insert	Torque*
JSVJ2BR/L062	0.375	0.375	5.000	0.780	0.375	0.375	0.008	VB**22...	0.89
JSVJ2BR/L082	0.500	0.500	5.000	0.780	0.500	0.500	0.008	VB**22...	0.89
JSVJ2BR/L102	0.625	0.625	5.000	0.780	0.625	0.625	0.008	VB**22...	0.89

Metric	h	b	L1	L2	h1	f	rε**	Insert	Torque*
JSVJ2BR/L1010X11	10	10	120	21	10	10	0.2	VB**1103...	1.2
JSVJ2BL1010K11	10	10	125	21	10	10	0.2	VB**1103...	1.2
JSVJ2BR/L1212F11	12	12	85	21	12	12	0.2	VB**1103...	1.2
JSVJ2BR/L1212X11	12	12	120	21	12	12	0.2	VB**1103...	1.2
JSVJ2BR1212K11	12	12	125	21	12	12	0.2	VB**1103...	1.2
JSVJ2BR/L1616X11	16	16	120	21	16	16	0.2	VB**1103...	1.2

*Torque: Recommended torque (lbf-ft, N-m) for clamping
 **re: Standard corner radius

SPARE PARTS		
Designation	Clamping screw	Wrench
JSVJ2BR/L...	CSTB-2.5	T-8F

Miniature Tool

J-SERIES

JSVJBR/L

Screw-on toolholder with 93° approach angle for positive 35° rhombic inserts

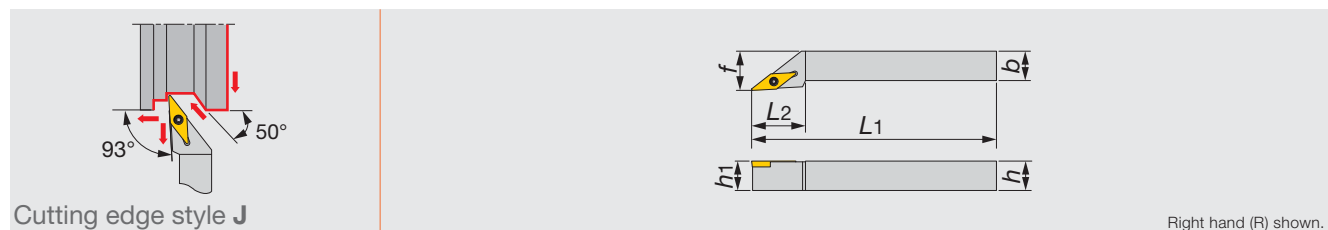

Metric	h	b	L1	L2	h1	f	rε**	Insert	Torque*
JSVJBR/L1010H11	10	10	100	20	10	12	0.016	VB**1103...	1.2
JSVJBR/L1212H11	12	12	100	22	12	16	0.016	VB**1103...	1.2
JSVJBR/L1616H11	16	16	100	22	16	20	0.016	VB**1103...	1.2

*Torque: Recommended torque (N-m) for clamping
 **re: Standard corner radius

SPARE PARTS		
Designation	Clamping screw	Wrench
JSVJBR/L...	CSTB-2.5	T-8F

Reference pages

JSVJ2BR/L, JSVJBR/L: Inserts → B147 -, CBN → B171 -

J-SERIES

JSVJ2BR/L-CHP

Screw-on toolholder without offset with 93° approach angle for positive 35° rhombic inserts, with channels for high pressure coolant

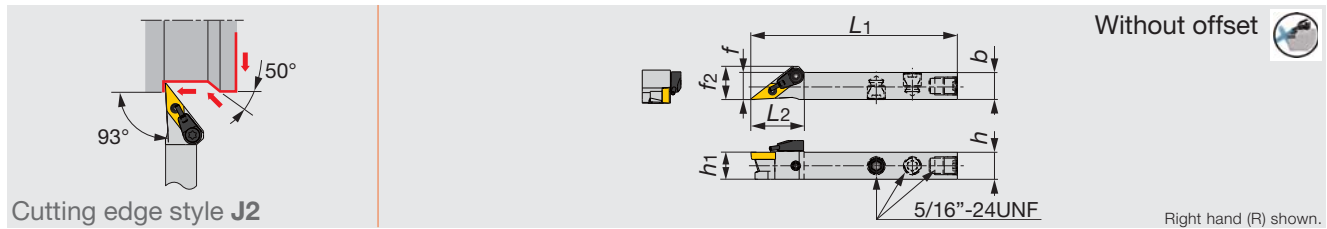

Inch	<i>h</i>	<i>b</i>	<i>L</i> ₁	<i>L</i> ₂	<i>h</i> ₁	<i>f</i>	<i>f</i> ₂	<i>r</i> _ε **	Insert	Torque*
JSVJ2BR/L082-CHP	0.500	0.500	3.344	0.930	0.500	0.500	0.610	0.008	VB**22...	0.9

Metric	<i>h</i>	<i>b</i>	<i>L</i> ₁	<i>L</i> ₂	<i>h</i> ₁	<i>f</i>	<i>f</i> ₂	<i>r</i> _ε **	Insert	Torque*
JSVJ2BR/L1212F11-CHP	12	12	85	23.6	12	12	14.7	0.2	VB**1103...	1.2

*Torque: Recommended torque (lbf-ft, N-m) for clamping
 **re: Standard corner radius

SPARE PARTS

Designation	Clamping screw	Coolant unit	Wrench
JSVJ2BR/L*-CHP	CSTB-2.5	S-CU-CHP	T-8F



Miniature Tool

J-SERIES

JSVABR/L

Screw-on toolholder without offset with 91° approach angle for positive 35° rhombic inserts

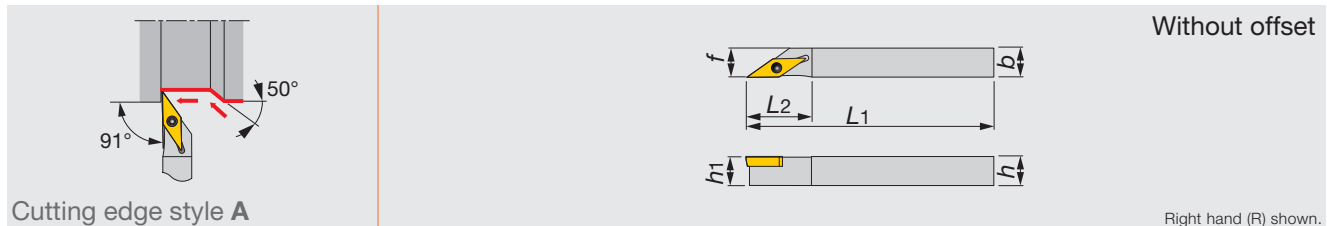

Metric	<i>h</i>	<i>b</i>	<i>L</i> ₁	<i>L</i> ₂	<i>h</i> ₁	<i>f</i>	<i>r</i> _ε **	Insert	Torque*
JSVABR/L1010K11	10	10	125	21	10	10	0.2	VB**1103...	1.2
JSVABL1212K11	12	12	125	21	12	12	0.2	VB**1103...	1.2
JSVABL1616K11	16	16	125	21	16	16	0.2	VB**1103...	1.2

*Torque: Recommended torque (N-m) for clamping
 **re: Standard corner radius

SPARE PARTS

Designation	Clamping screw	Wrench
JSVABR/L...	CSTB-2.5	T-8F

Reference pages

JSVJ2BR/L-CHP, JSVABR/L: Inserts → B147 -, CBN → B171 -

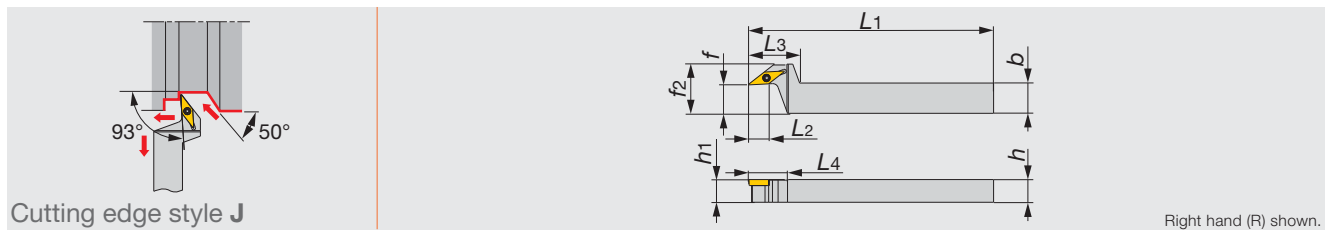

Cutting edge style J

Metric	<i>h</i>	<i>b</i>	<i>L</i> ₁	<i>L</i> ₂	<i>L</i> ₃	<i>L</i> ₄	<i>h</i> ₁	<i>f</i>	<i>f</i> ₂	<i>r</i> _ε **	Insert	Torque*
JSVJBR1216F11-F15	12	16	85	12.6	27	21	12	15	26	0.2	VB**1103...	1.2
JSVJBR1216X11-F15	12	16	120	12.6	27	21	12	15	26	0.2	VB**1103...	1.2
JSVJBR1620X11-F15	16	20	120	12.6	27	21	16	15	26	0.2	VB**1103...	1.2

*Torque: Recommended torque (N·m) for clamping

**re: Standard corner radius

SPARE PARTS

Designation	Clamping screw	Wrench
JSVJBR**-F15	CSTB-2.5	T-8F



Miniature Tool

Reference pages

JSVJBR-F: Inserts → B147 -, CBN → B171 -

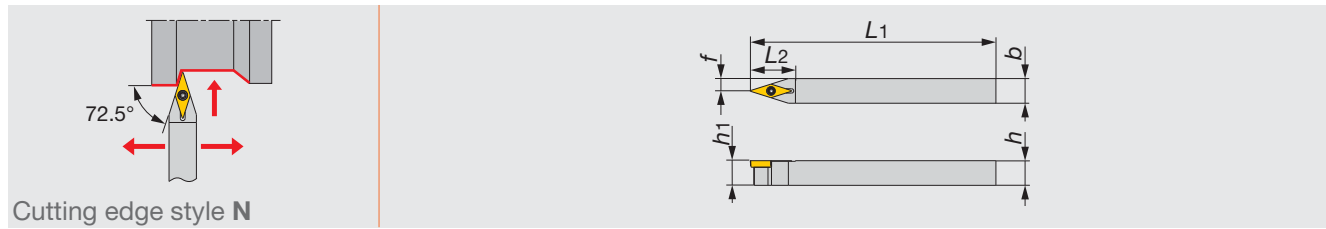

Cutting edge style N

Metric	<i>h</i>	<i>b</i>	<i>L1</i>	<i>L2</i>	<i>h1</i>	<i>f</i>	<i>r_ε**</i>	Insert	Torque*
JSVNBN1010X11	10	10	120	22	10	5	0.2	VB**1103...	1.2
JSVNBN1212F11	12	12	85	22	12	6	0.2	VB**1103...	1.2
JSVNBN1212X11	12	12	120	22	12	6	0.2	VB**1103...	1.2
JSVNBN1616X11	16	16	120	22	16	8	0.2	VB**1103...	1.2

*Torque: Recommended torque (N·m) for clamping
 **re: Standard corner radius



Miniature Tool

SPARE PARTS

Designation	Clamping screw	Wrench
JSVNBN...	CSTB-2.5	T-8F



Reference pages

JSVNBN: Inserts → **B147 -**, CBN → **B171 -**

J-SERIES

JSVL2PR/L

Screw-on toolholder without offset with 95° approach angle for positive 35° rhombic inserts

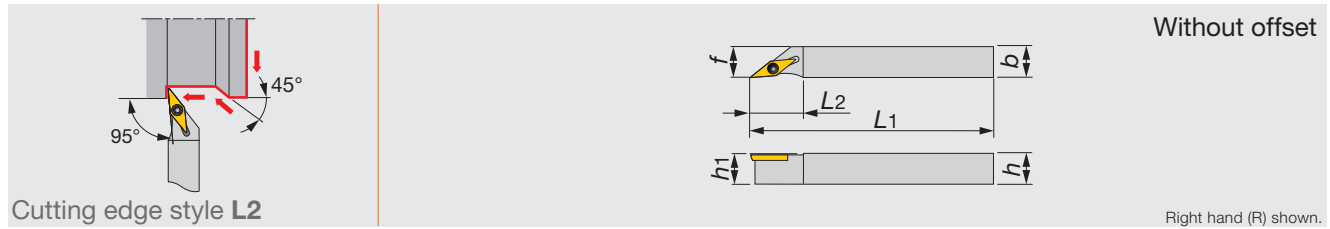

Inch	h	b	L1	L2	h1	f	r _e **	Insert	Torque*
JSVL2PR/L082	0.500	0.500	5.000	18.000	0.500	0.500	0.008	VP**63...	0.89
JSVL2PR/L102	0.625	0.625	5.000	20.000	0.625	0.625	0.008	VP**63...	0.89

Metric	h	b	L1	L2	h1	f	r _e **	Insert	Torque*
JSVL2PR/L1010X08	10	10	120	16	10	10	0.2	VP**0802...	0.6
JSVL2PR/L1010K08	10	10	125	16	10	10	0.2	VP**0802...	0.6
JSVL2PR/L1212F08	12	12	85	16	12	12	0.2	VP**0802...	0.6
JSVL2PR/L1212F11	12	12	85	21	12	12	0.2	VP**1103...	1.2
JSVL2PR/L1212X08	12	12	120	16	12	12	0.2	VP**0802...	0.6
JSVL2PR/L1212X11	12	12	120	21	12	12	0.2	VP**1103...	1.2
JSVL2PR/L1212K08	12	12	125	16	12	12	0.2	VP**0802...	0.6
JSVL2PR/L1616X08	16	16	120	16	16	16	0.2	VP**0802...	0.6
JSVL2PL1616K08	16	16	125	16	16	16	0.2	VP**0802...	0.6
JSVL2PR/L1616X11	16	16	120	21	16	16	0.2	VP**1103...	1.2

*Torque: Recommended torque (lbf-ft, N-m) for clamping
 **r_e: Standard corner radius

SPARE PARTS

Designation	Clamping screw	Wrench
JSVL2PR/L082/102	CSTB-2L	T-8F
JSVL2PR/L**08	CSTB-2L	T-6F
JSVL2PR/L**11	CSTB-2.5	T-8F



Miniature Tool

J-SERIES

JSVP2PR/L

Screw-on toolholder without offset with 117.5° approach angle for positive 35° rhombic inserts

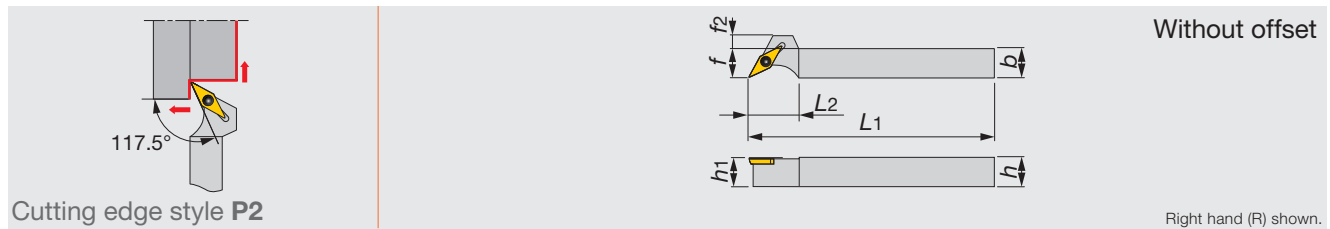

Metric	h	b	L1	L2	h1	f	f2	r _e **	Insert	Torque*
JSVP2PR/L1010K08	10	10	125	16	10	10	4	0.2	VP**0802...	0.6
JSVP2PR/L1010K11	10	10	125	20	10	10	8	0.2	VP**1103...	1.2
JSVP2PR/L1212K08	12	12	125	16	12	12	2	0.2	VP**0802...	0.6
JSVP2PR/L1212K11	12	12	125	20	12	12	6	0.2	VP**1103...	1.2
JSVP2PR/L1616K08	16	16	125	16	16	16	2	0.2	VP**0802...	0.6
JSVP2PR/L1616K11	16	16	125	20	16	16	6	0.2	VP**1103...	1.2

*Torque: Recommended torque (N-m) for clamping
 **r_e: Standard corner radius

SPARE PARTS

Designation	Clamping screw	Wrench
JSVP2PR/L**08	CSTB-2L	T-6F
JSVP2PR/L**11	CSTB-2.5	T-8F

Reference pages

JSVL2PR/L, JSVP2PR/L: Inserts → **B151**

PCLNR

Lever lock type toolholder with 95° approach angle for negative 80° rhombic inserts

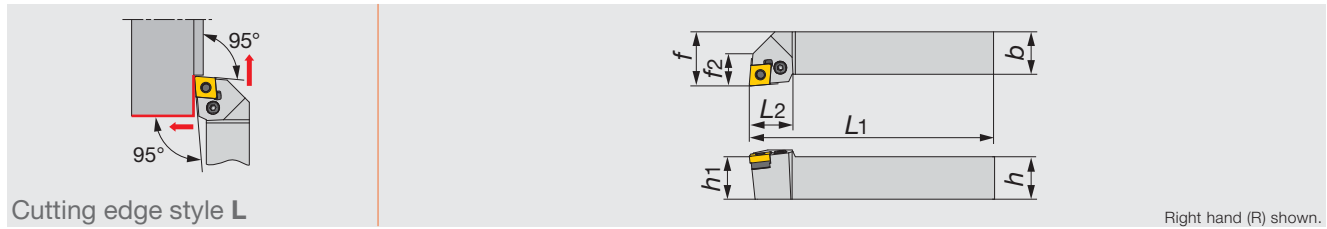

Metric	h	b	L1	L2	h1	f	f2	re**	Insert	Torque*
PCLNR2020H12	20	20	100	26	20	25	18	0.8	CN**1204...	3

*Torque: Recommended torque (N-m) for clamping
 **re: Standard corner radius

SPARE PARTS

Designation	Shim	Clamping screw	Lever	Spring pin	Wrench
PCLNR2020H12	LSC42	LCS4	LCL4	LSP4	P-3

PCL2NR

Lever lock type toolholder without offset with 95° approach angle for negative 80° rhombic inserts

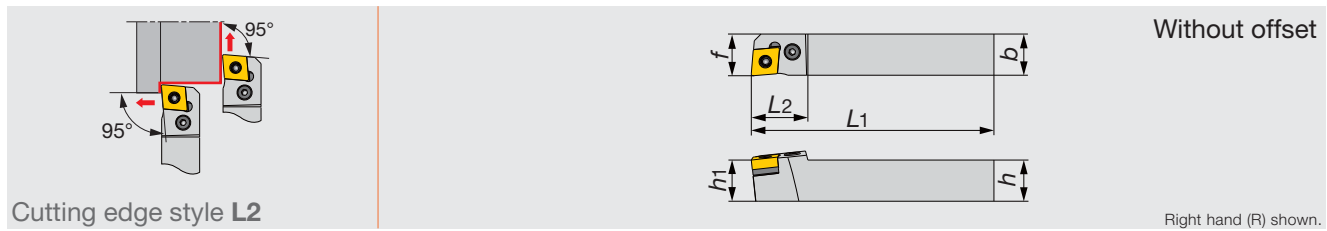

Metric	h	b	L1	L2	h1	f	re**	Insert	Torque*
PCL2NR2020H12	20	20	100	26	20	20	0.8	CN**1204...	3

*Torque: Recommended torque (N-m) for clamping
 **re: Standard corner radius

SPARE PARTS

Designation	Shim	Clamping screw	Lever	Spring pin	Wrench
PCL2NR2020H12	LSC42	LCS4	LCL4	LSP4	P-3

PDJNR

Lever lock type toolholder with 93° approach angle for negative 55° rhombic inserts

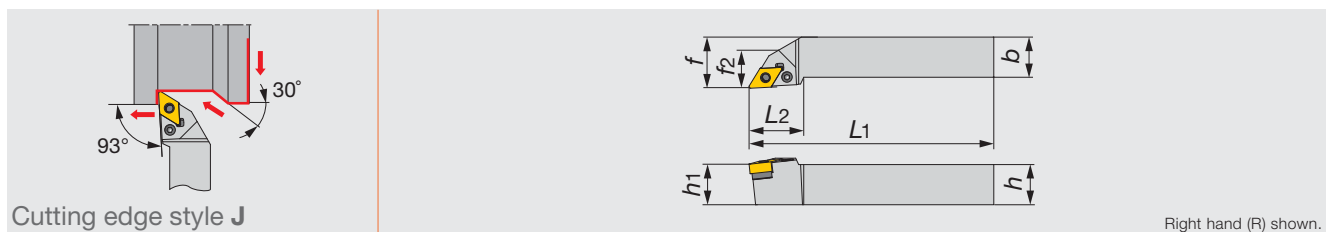

Metric	h	b	L1	L2	h1	f	f2	re**	Insert	Torque*
PDJNR2020H15	20	20	100	32	20	25	20	0.8	DN**1504...	3

*Torque: Recommended torque (N-m) for clamping
 **re: Standard corner radius

SPARE PARTS

Designation	Shim	Clamping screw	Lever	Spring pin	Wrench
PDJNR2020H15	LSD42	LCS4	LCL4	LSP4	P-3

Reference pages

PCLNR, PCL2NR: Inserts → B052 -, CBN → B165

PDJNR: Inserts → B063 -, CBN → B165

J-SERIES

JTTANR/L

Back clamp toolholder without offset with 91° approach angle for negative 60° triangular inserts

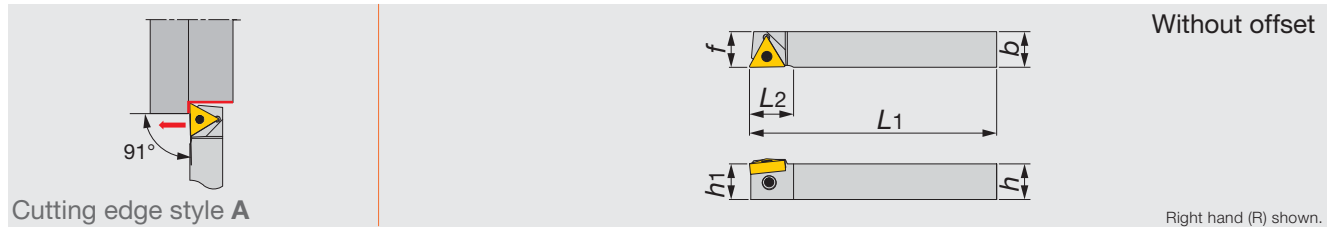

Metric	h	b	L1	L2	h1	f	rε**	Insert	Torque*
JTTANR/L1216K16	12	16	125	19.8	12	16	0.4	TN**1604...	1.2
JTTANR/L1616K16	16	16	125	19.8	16	16	0.4	TN**1604...	1.2

*Torque: Recommended torque (N-m) for clamping
 **re: Standard corner radius

SPARE PARTS

Designation	Clamp	Clamping screw	Wrench
JTTANR/L...	JCP-3N	JDS-5040	P-2.5F

J-SERIES

JTTLNR/L

Back clamp toolholder without offset with 95° approach angle for negative 60° triangular inserts

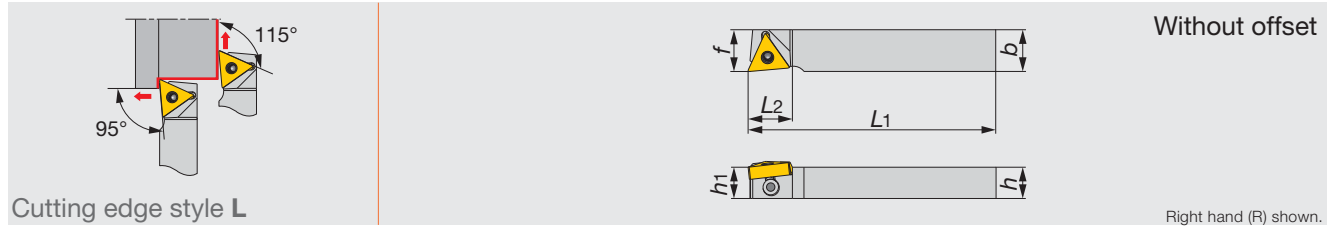

Metric	h	b	L1	L2	h1	f	rε**	Insert	Torque*
JTTLNR/L1216F16	12	16	85	17	12	16	0.4	TN**1604...	1
JTTLNR/L1216X16	12	16	120	17	12	16	0.4	TN**1604...	1
JTTLNR/L1616X16	16	16	120	17	16	16	0.4	TN**1604...	1

*Torque: Recommended torque (N-m) for clamping
 **re: Standard corner radius

SPARE PARTS

Designation	Clamp	Clamping screw	Wrench
JTTLNR/L...	JCP-3N	JDS-5040	P-2.5F



Miniature Tool

Reference pages

JTTANR/L, JTTLNR/L: Inserts → B082 -, CBN → B166 -, PCD → B178 -

PTL2NR/L

Lever lock type toolholder without offset with 95° approach angle for negative 60° triangular inserts

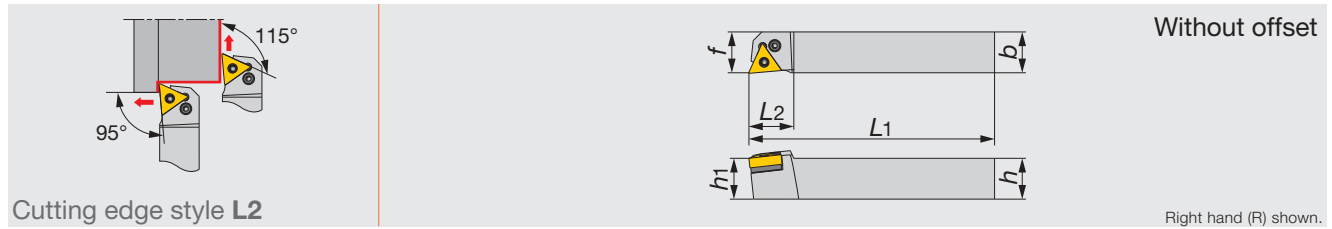

Metric	h	b	L1	L2	h1	f	re**	Insert	Torque*
PTL2NR/L2020H16	20	20	100	22	20	20	0.4	TN**1604...	2

*Torque: Recommended torque (N-m) for clamping
 **re: Standard corner radius

SPARE PARTS

Designation	Shim	Clamping screw	Lever	Spring pin	Wrench
PTL2NR/L2020H16	LST317	LCS3	LCL3	LSP3	P-2.5



Miniature Tool

PARTS FOR COOLANT HOSE

Connecting hose

Fig. 1

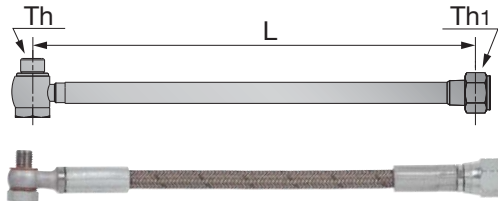
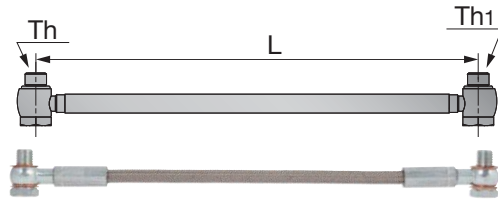
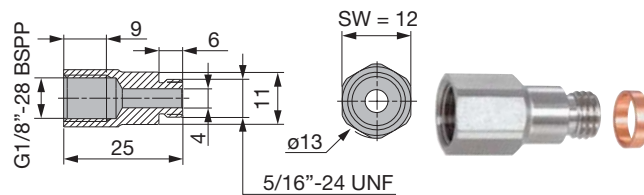

Fig. 2



Metric	L	Th	Th1	Max. pressure (Mpa)	Fig.
CHP-HOSE-G1/8-7/16-200BS	200	G1/8"-28 BSPP	7/16"-20 UNF	26	1
CHP-HOSE-G1/8-7/16-250BS	250	G1/8"-28 BSPP	7/16"-20 UNF	26	1
CHP-HOSE-5/16-7/16-200BS	200	5/16"-24UNF	7/16"-20 UNF	20	1
CHP-HOSE-5/16-G1/8-200BS	200	5/16"-24UNF	G1/8"-28 BSPP	20	1
CHP-HOSE-G1/8-G1/8-200BB	200	G1/8"-28 BSPP	G1/8"-28 BSPP	26	2
CHP-HOSE-G1/8-G1/8-250BB	250	G1/8"-28 BSPP	G1/8"-28 BSPP	26	2

Connector for small lathe with seal washer



Metric
CHP-CONECTOR/5/16-G1/8

Seal washer



Metric	øD	ød	W
CHP-COPPER-SEAL1/8	15	10	1
CHP-COPPER-SEAL5/16	11	8	1
CHP-COPPER-SEAL5/16-2.5	11	8	2.5

Reference pages

PTL2NR/L: Inserts → B082 -, CBN → B166 -, PCD → B178 -

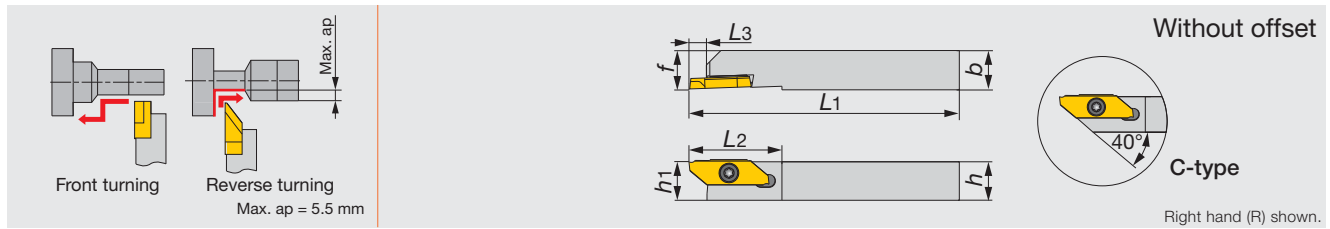

Metric	h	b	L1	L2	L3	h1	f	Insert
JSXGR/L1010K8-C	10	10	125	29	6.7	10	10	JXFR/L8..., JXRR/L8...
JSXGR/L1212K8-C	12	12	125	29	6.7	12	12	JXFR/L8..., JXRR/L8...
JSXGR/L1616K8	16	16	125	29	6.5	16	16	JXFR/L8..., JXRR/L8...
JSXGR/L2020K8	20	20	125	29	6.5	20	20	JXFR/L8..., JXRR/L8...
JSXGR/L2525K8	25	25	125	29	6.5	25	25	JXFR/L8..., JXRR/L8...

- Can be wrenched also from the back with a double-head screw.
- This toolholders can be used for JXF insert (front-turning), JXR insert (reverse-turning), JXG insert (grooving)

SPARE PARTS

Designation	Clamping screw	Wrench	Wrench 1 (Optional parts)
JSXGR/L...	CSTB-4SD	T-8F	(T-8L)



Miniature Tool

INSERT

JXF (front turning, sharp edge)

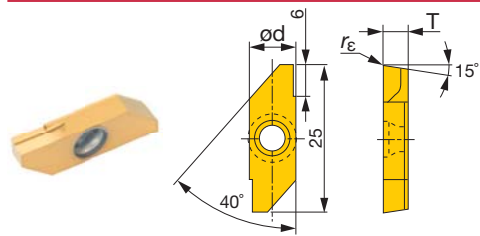

Designation	rε (mm)	Coated J740		Uncoated TH10		ød (mm)	T (mm)	Max. depth of cut (mm)
		R	L	R	L			
JXFR/L8000F	0.03	●		●		8	3.97	5.5
JXFR/L8010F	0.1	●		●		8	3.97	5.5

● : Line up

JXR (reverse turning, sharp edge)

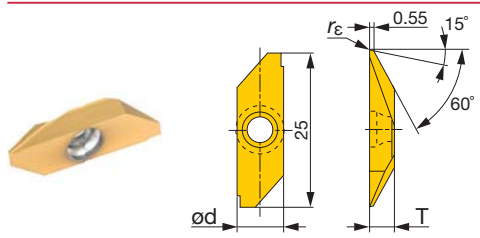

Designation	rε (mm)	Coated J740		Uncoated TH10		ød (mm)	T (mm)	Max. depth of cut (mm)
		R	L	R	L			
JXRR/L8000F	0.03	●		●		8	3.97	5.5
JXRR/L8010F	0.1	●		●		8	3.97	5.5

● : Line up

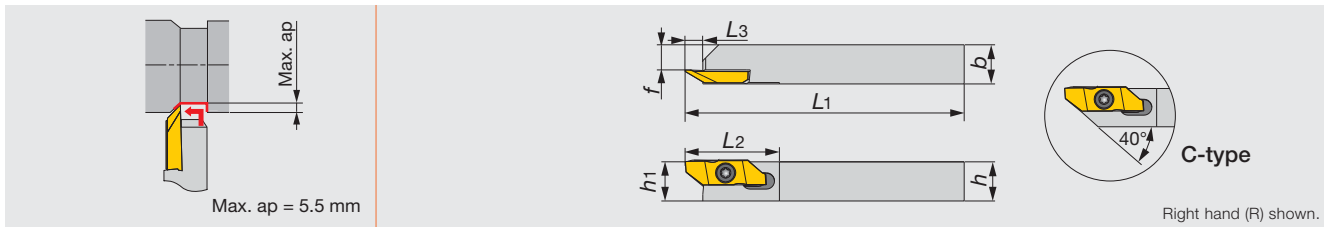

Metric	h	b	L1	L2	L3	h1	f	Insert
JSXBR/L1010K8-C	10	10	125	29	6.7	10	5.7	JXBR/L8..., JXT*R...
JSXBR/L1212K8-C	12	12	125	29	6.7	12	7.7	JXBR/L8..., JXT*R...
JSXBR/L1616K8	16	16	125	29	6.4	16	11.7	JXBR/L8..., JXT*R...
JSXBR/L2020K8	20	20	125	29	6.4	20	15.7	JXBR/L8..., JXT*R...
JSXBR/L2525K8	25	25	125	29	6.4	25	20.7	JXBR/L8..., JXT*R...

- Can be wrenched also from the back with a double-head screw.
- This toolholders can be used for JXB insert (back-turning), JXT insert (threading)

SPARE PARTS

Designation	Clamping screw	Wrench
JSXBR/L...	CSTB-4SD	T-8F

INSERT

JXB (sharp edge)

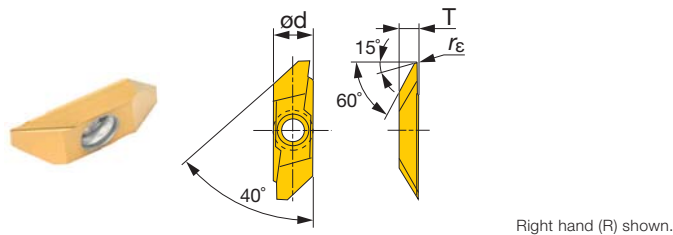

Designation	rε (mm)	Coated J740		Uncoated TH10		ød (mm)	T (mm)	Max. depth of cut (mm)
		R	L	R	L			
JXBR/L8000F	0.03	●	●	●	●	8	3.97	5.5
JXBR/L8005F	0.05	●	●	●	●	8	3.97	5.5
JXBR/L8010F	0.1	●	●	●	●	8	3.97	5.5
JXBR/L8015F	0.15	●	●	●	●	8	3.97	5.5

● : Line up

JXB (with honing)

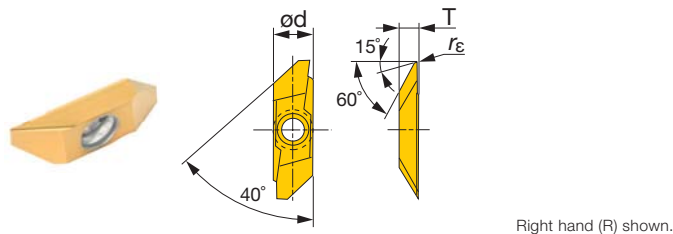

Designation	rε (mm)	Coated J740		ød (mm)	T (mm)	Max. depth of cut (mm)
		R	L			
JXBR/L8005	0.05	●	●	8	3.97	5.5
JXBR/L8010	0.1	●	●	8	3.97	5.5
JXBR/L8015	0.15	●	●	8	3.97	5.5

● : Line up



Miniature Tool

J-SERIES

JSTBR/L

Screw-on toolholder for back turning

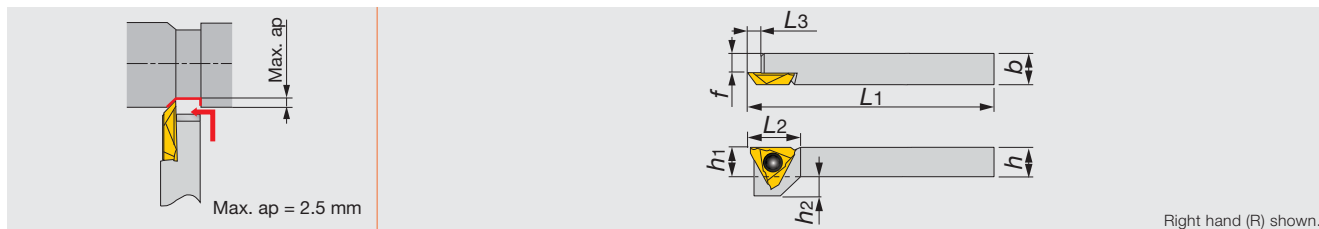

Right hand (R) shown.

Inch	<i>h</i>	<i>b</i>	<i>L1</i>	<i>L2</i>	<i>L3</i>	<i>h1</i>	<i>f</i>	<i>h2</i>	Insert	Torque*
JSTBR/L063	0.375	0.375	5.000	0.625	0.197	0.375	0.218	0.250	JTBR/L3...	0.89
JSTBR/L083	0.500	0.500	5.000	0.625	0.197	0.500	0.312	0.125	JTBR/L3...	0.89
JSTBR/L103	0.625	0.625	5.000	0.625	0.197	0.625	0.468	-	JTBR/L3...	0.89

Metric	<i>h</i>	<i>b</i>	<i>L1</i>	<i>L2</i>	<i>L3</i>	<i>h1</i>	<i>f</i>	<i>h2</i>	Insert	Torque*
JSTBR/L1010X3	10	10	120	15	5	10	6	5	JTBR/L3...	1.2
JSTBL1010K3	10	10	125	15	5	10	6	5	JTBR/L3...	1.2
JSTBR/L1212F3	12	12	85	15	5	12	8	3	JTBR/L3...	1.2
JSTBR/L1212X3	12	12	120	15	5	12	8	3	JTBR/L3...	1.2
JSTBR/L1616X3	16	16	120	15	5	16	12	-	JTBR/L3...	1.2

*Torque: Recommended torque (lbf-ft, N-m) for clamping

SPARE PARTS

Designation	Clamping screw	Wrench
JSTBR/L...	CSTB-4SD	T-8F



Miniature Tool

J-SERIES

JS-TBL3

Screw-on toolholder for back turning

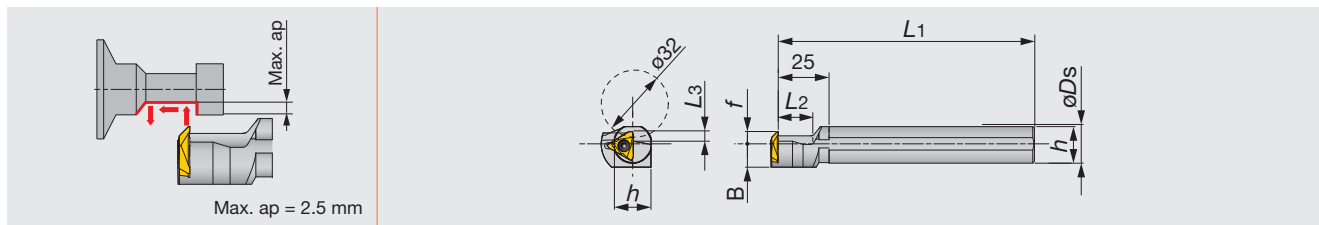

Metric	ϕDs	<i>f</i>	<i>L1</i>	<i>L2</i>	<i>L3</i>	<i>h</i>	<i>B</i>	Insert	Torque*
JS19K-TBL3	19.05	6	125	17	4.5	18	11.5	JTBR3...	3
JS20K-TBL3	20	6	125	17	4.5	19	11.5	JTBR3...	3
JS22K-TBL3	22	6	125	17	4.5	21	11.5	JTBR3...	3
JS25K-TBL3	25.4	10	125	17	4.5	24	12.7	JTBR3...	3

*Torque: Recommended torque (N-m) for clamping

SPARE PARTS

Designation	Clamping screw	Wrench
JS**-TBL3	CSTB-4S	T-15F

Reference pages

JSTBR/L, JS-TBL3: Inserts → **B382**, Standard cutting conditions → **B382**

INSERT

JTB (sharp edge)

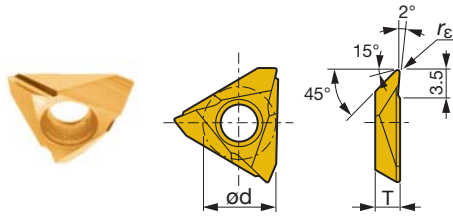

Right hand (R) shown.

Designation	r_{ϵ} (mm)	Coated		Cermet		Uncoated		ϕd (mm)	T (mm)	Max. depth of cut (mm)
		J740	SH725	NS9530	TH10					
JTBR/L3000F	0.03	●	●	●	●	●	●	9.438	3.18	2.5
JTBR/L3005F	0.05	●	●	●	●		●	9.438	3.18	2.5
JTBR/L3010F	0.1	●	●	●	●	●	●	9.438	3.18	2.5
JTBR/L3015F	0.15	●	●	●				9.438	3.18	2.5

● : Line up

JTB (with honing)

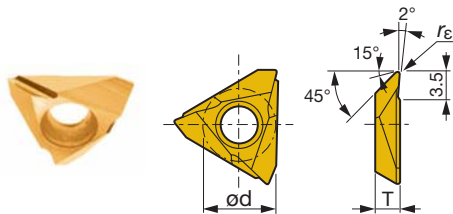

Right hand (R) shown.

Designation	r_{ϵ} (mm)	Coated		Coated cermet		ϕd (mm)	T (mm)	Max. depth of cut (mm)
		J740	J9530					
JTBR/L3005	0.05	●	●	●	●	9.438	3.18	2.5
JTBR/L3010	0.1	●	●	●	●	9.438	3.18	2.5

● : Line up

STANDARD CUTTING CONDITIONS (JTB type insert)

ISO	Workpiece material	Grade	Cutting speed V_c (sfm)	Feed f (ipr)
P	General steel 1045, etc.	SH725	164 - 656	0.000 - 0.004
		J740	33 - 328	0.000 - 0.004
		NS9530	164 - 492	0.000 - 0.004
		J9530	164 - 492	0.000 - 0.004
M	Free-cutting steel	SH725	164 - 656	0.000 - 0.004
		J740	33 - 328	0.000 - 0.004
M	Stainless steel 303, etc.	SH725	164 - 656	0.000 - 0.004
		J740	33 - 328	0.000 - 0.004
		NS9530	164 - 492	0.000 - 0.004
		J9530	164 - 492	0.000 - 0.004
N	Aluminum alloys, Brass 5056, 6061, etc.	TH10	33 - 656	0.000 - 0.004
S	Difficult-to-machine material, Titanium alloys Ti-6Al-4V, etc.	TH10	33 - 98	0.000 - 0.004



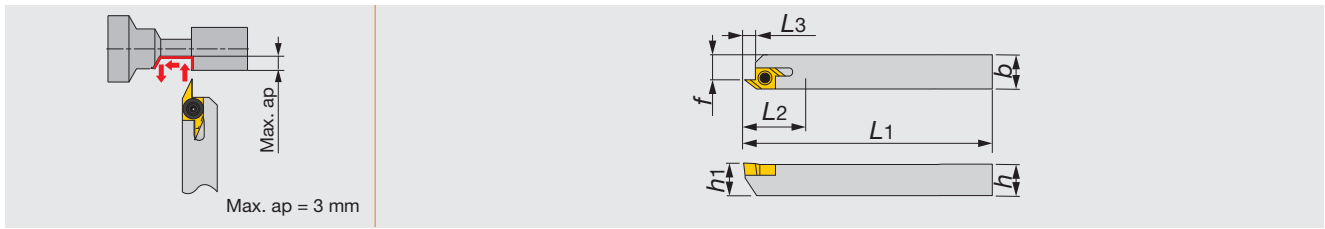

Metric	h	b	L1	L2	L3	h1	f	Insert	Torque*
JSEGR/L1010K10	10	10	125	-	3.3	10	7.5	J10ER/L...	1.2
JSEGR/L1212K10	12	12	125	-	3.3	12	9.5	J10ER/L...	1.2
JSEGR/L1616K10	16	16	125	-	3.3	16	13.5	J10ER/L...	1.2

*Torque: Recommended torque (N-m) for clamping

SPARE PARTS

Designation	Clamping screw	Wrench
JSEGR/L...	CSTB-2.5	T-8F

INSERT

J10E (sharp edge)

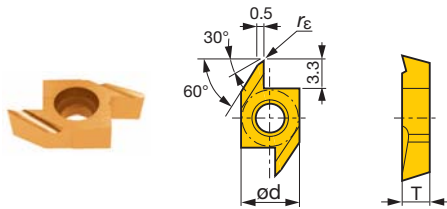

Right hand (R) shown.

Designation	re (mm)	Coated		Cermet		Uncoated		ød (mm)	T (mm)	Max. depth of cut (mm)
		J740		NS9530		TH10				
		R	L	R	L	R	L			
J10ER/L005BF	0.05	●	●	●	●	●	●	6.35	3.18	3
J10ER/L010BF	0.1	●	●	●	●	●	●	6.35	3.18	3
J10ER/L015BF	0.15			●	●			6.35	3.18	3

● : Line up

J10E (with honing)

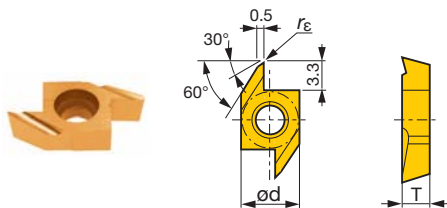

Right hand (R) shown.

Designation	re (mm)	Coated		Coated cermet		ød (mm)	T (mm)	Max. depth of cut (mm)
		J740		J9530				
		R	L	R	L			
J10ER/L005B	0.05	●	●	●	●	6.35	3.18	3
J10ER/L010B	0.1	●	●	●	●	6.35	3.18	3

● : Line up

Reference pages

JSEGR/L: Inserts → B383 -, Standard cutting conditions → B384



Miniature Tool

STANDARD CUTTING CONDITIONS (J10E type insert)

ISO	Workpiece material	Grade	Cutting speed Vc (sfm)	Feed f (ipr)
P	General steel 1045, etc.	SH725	164 - 656	0.000 - 0.004
		J740	33 - 328	0.000 - 0.004
		NS9530	164 - 492	0.000 - 0.004
		J9530	50 - 150	0.000 - 0.004
	Free-cutting steel	SH725	164 - 656	0.000 - 0.004
		J740	33 - 328	0.000 - 0.004
M	Stainless steel 303, etc.	SH725	164 - 656	0.000 - 0.004
		J740	33 - 328	0.000 - 0.004
		NS9530	164 - 492	0.000 - 0.004
		J9530	164 - 492	0.000 - 0.004
N	Aluminum alloys, Brass 5056, 6061, etc.	TH10	33 - 656	0.000 - 0.004
S	Difficult-to-machine material, Titanium alloys Ti-6Al-4V, etc.	TH10	33 - 98	0.000 - 0.004



Miniature Tool

INSERT

10E (Insert blank)

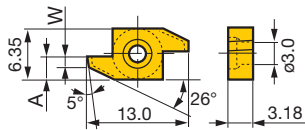

Right hand (R) shown.

Designation	Uncoated TH10		W (mm)	A (mm)
	R	L		
10ER/L100B	●	●	1	2.5
10ER/L150B	●	●	1.5	3

● : Line up

Note: Right hand holder (JSEGR...) use right hand insert (10ER...) and left hand holder (JSEGL...) use left hand insert (10EL...).

10E (Insert blank)

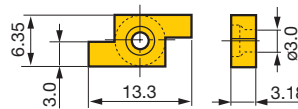

Right hand (R) shown.

Designation	Uncoated TH10	
	R	L
10ER/L300	●	●

● : Line up

Note: Right hand holder (JSEGR...) use right hand insert (10ER...) and left hand holder (JSEGL...) use left hand insert (10EL...).

Formed examples of insert blanks

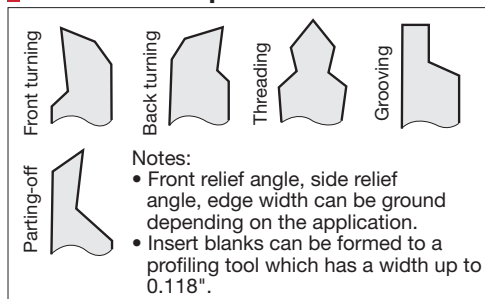

Standard cutting conditions

Operations	Workpiece material	Carbon steels	Stainless steels	Brass	
		~ 330	~ 160	~ 650	
Lateral feed (external turning)	Cutting speed (sfm)	~ 330	~ 160	~ 650	
	Feed (ipr)	Roughing	~ 0.002	~ 0.001	~ 0.004
		Medium	~ 0.001	~ 0.001	~ 0.002
	Finishing	~ 0.0007	~ 0.0006	~ 0.004	
Parting-off Grooving Forming	Cutting speed (sfm)	~ 260	~ 100	~ 500	
	Feed (ipr)	Roughing	~ 0.0007	~ 0.0006	~ 0.002
		Medium	~ 0.0006	~ 0.0004	~ 0.001
	Finishing	~ 0.0004	~ 0.0003	~ 0.0006	

MEMO

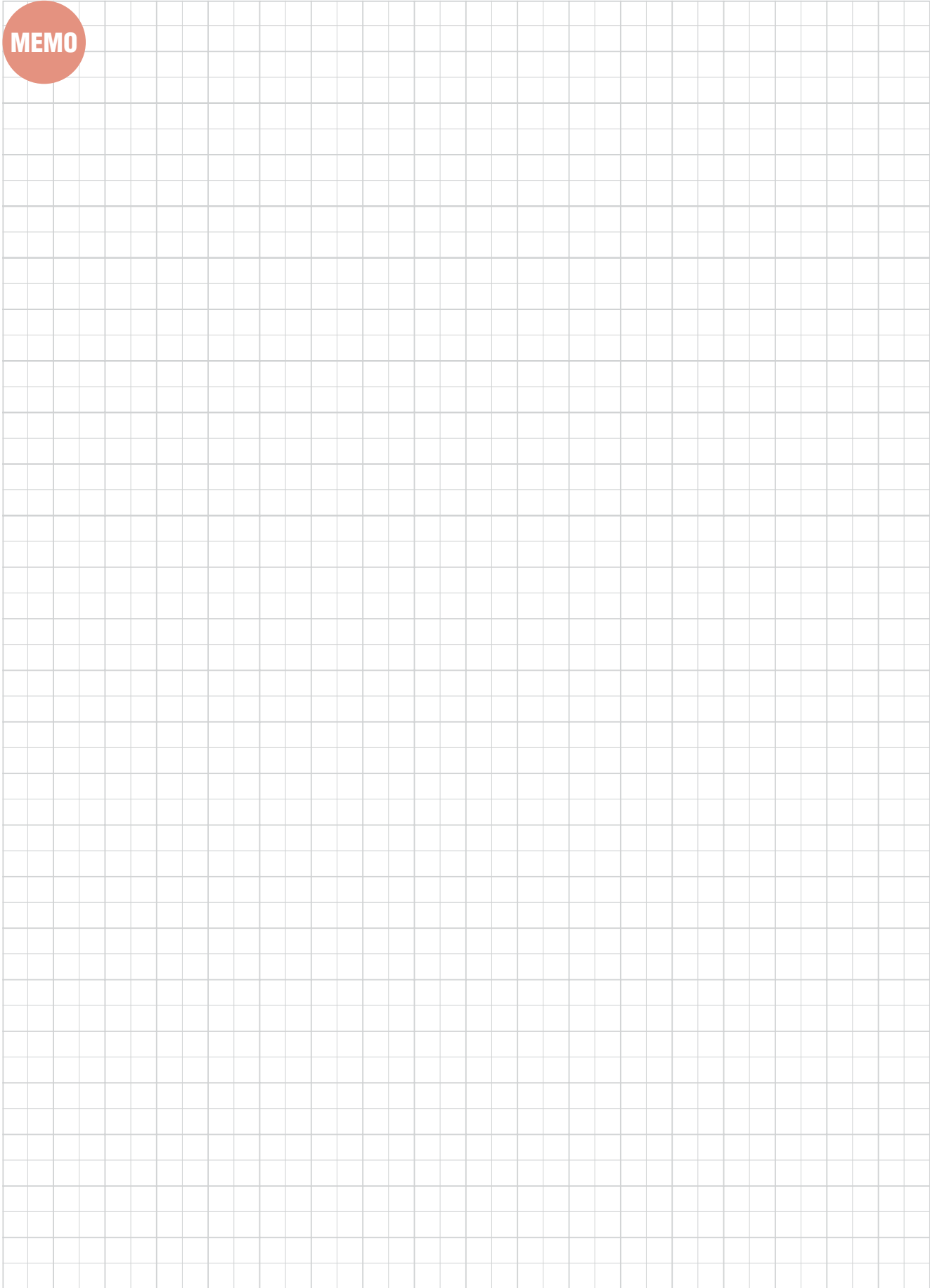

Miniature Tool

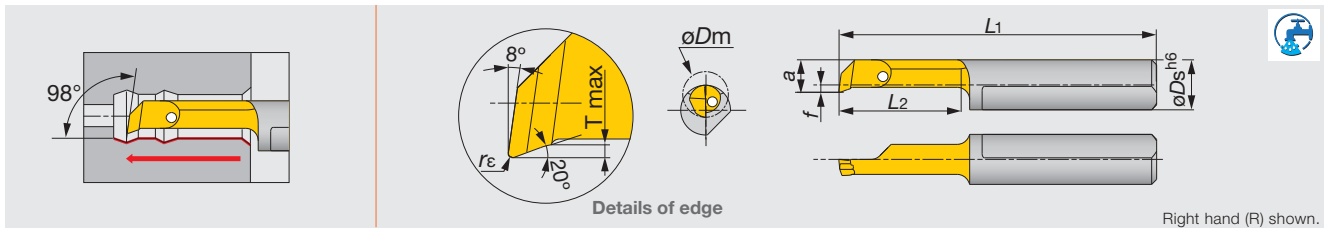

Right hand (R) shown.

Miniature Tool

Metric	SH730	ϕD_m	ϕD_s	f	a	L_1	L_2	T max	$r\epsilon_0^{+0.05}$
JBTR04020004-D006	●	0.6	4	-	0.5	18.5	2	0.08	0.04
JBTR04030004-D006	●	0.6	4	-	0.5	19.5	3	0.08	0.04
JBTR04045005-D010	●	1	4	-	0.9	21	4.5	0.1	0.05
JBTR04065005-D010	●	1	4	-	0.9	23	6.5	0.1	0.05
JBTR04040005-D020	●	2	4	-	1.7	20.5	4	0.1	0.05
JBTR04090005-D020	●	2	4	-	1.7	25.5	9	0.1	0.05
JBTR04140005-D020	●	2	4	-	1.7	30.5	14	0.1	0.05
JBTR/L04090010-D028	●	3.5	4	0.6	2.6	25.5	9	0.2	0.1
JBTR/L04150010-D028	●	3.5	4	0.6	2.6	31.5	15	0.2	0.1
JBTR/L04190010-D028	●	3.5	4	0.6	2.6	35.5	19	0.2	0.1
JBTR/L04090010-D040	●	4	4	1.5	3.5	25.5	9	0.3	0.1
JBTR/L04150010-D040	●	4	4	1.5	3.5	31.5	15	0.3	0.1
JBTR/L04190010-D040	●	4	4	1.5	3.5	35.5	19	0.3	0.1
JBTR04230010-D040	●	4	4	1.5	3.5	39.5	23	0.3	0.1
JBTR04270010-D040	●	4	4	1.5	3.5	43.5	27	0.3	0.1
JBTR/L07090015-D050	●	5	7	0.9	4.4	25	9	0.5	0.15
JBTR/L07140015-D050	●	5	7	0.9	4.4	30	14	0.5	0.15
JBTR/L07190015-D050	●	5	7	0.9	4.4	35	19	0.5	0.15
JBTR/L07240015-D050	●	5	7	0.9	4.4	40	24	0.5	0.15
JBTR/L07290015-D050	●	5	7	0.9	4.4	45	29	0.5	0.15
JBTR07340015-D050	●	5	7	0.9	4.4	50	34	0.5	0.15
JBTR/L07140015-D060	●	6	7	1.8	5.3	30	14	0.5	0.15
JBTR/L07210015-D060	●	6	7	1.8	5.3	37	21	0.5	0.15
JBTR/L07240015-D060	●	6	7	1.8	5.3	40	24	0.5	0.15
JBTR/L07290015-D060	●	6	7	1.8	5.3	45	29	0.5	0.15
JBTR07340015-D060	●	6	7	1.8	5.3	50	34	0.5	0.15
JBTR07410015-D060	●	6	7	1.8	5.3	57	41	0.5	0.15
JBTR/L07190015-D068	●	6.8	7	2.8	6.3	35	19	0.6	0.15
JBTR07240015-D068	●	6.8	7	2.8	6.3	40	24	0.6	0.15
JBTR/L07290015-D068	●	6.8	7	2.8	6.3	45	29	0.6	0.15
JBTR/L07340015-D070	●	7	7	2.8	6.3	50	34	0.6	0.15
JBTR07390015-D070	●	7	7	2.8	6.3	55	39	0.6	0.15
JBTR07440015-D070	●	7	7	2.8	6.3	60	44	0.6	0.15
JBTR07490015-D070	●	7	7	2.8	6.3	65	49	0.6	0.15

● : Line up

Reference pages

Standard cutting conditions → **B393**

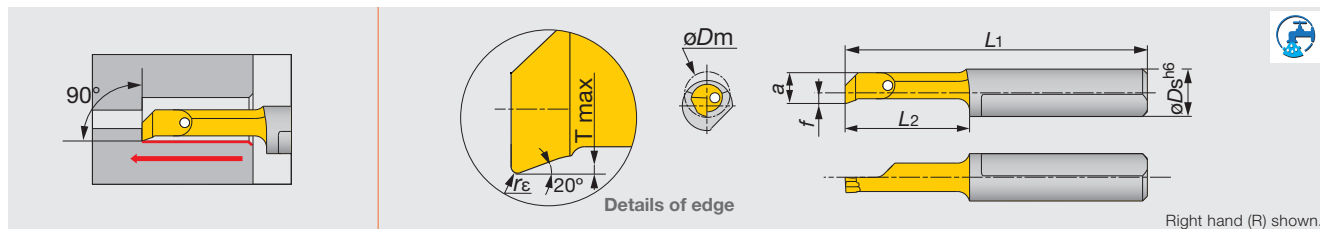

Metric	SH730	ϕD_m	ϕD_s	f	a	L_1	L_2	T max	$r_{\epsilon}^{+0.05}$
JBPR04090010-D028	●	3.5	4	0.9	2.6	25.5	9	0.2	0.1
JBPR04150010-D028	●	3.5	4	0.9	2.6	31.5	15	0.2	0.1
JBPR04090010-D040	●	4	4	1.5	3.5	25.5	9	0.3	0.1
JBPR04150010-D040	●	4	4	1.5	3.5	31.5	15	0.3	0.1
JBPR07140015-D050	●	5	7	0.9	4.4	30	14	0.5	0.15
JBPR07190015-D050	●	5	7	0.9	4.4	35	19	0.5	0.15

● : Line up

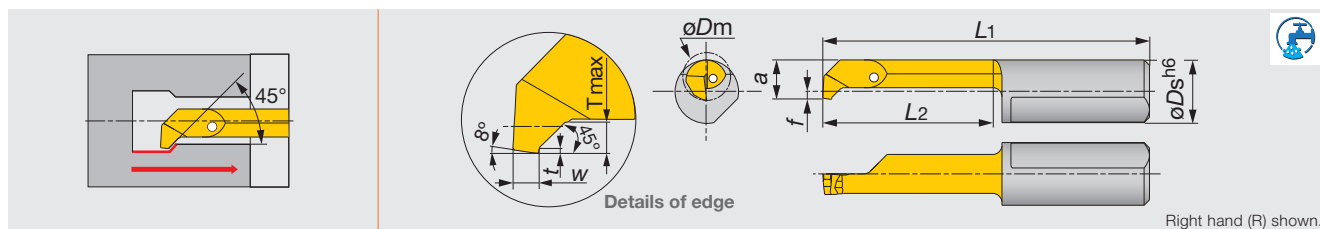

Metric	SH730	ϕD_m	ϕD_s	f	a	L_1	L_2	t	T max	$W^{+0.05}$
JBUR07140010-D050	●	5	7	0.9	4.4	30	14	0.2	1	1
JBUR07190010-D050	●	5	7	0.9	4.4	35	19	0.2	1	1

● : Line up

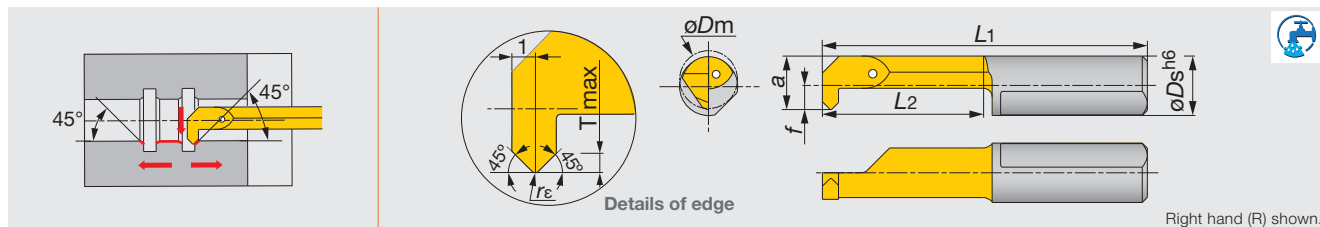

Metric	SH730	ϕD_m	ϕD_s	f	a	L_1	L_2	T max	$r_{\epsilon}^{\pm 0.05}$
JBCR07140020-D050	●	5	7	0.9	4.4	30	14	0.7	0.2
JBCR07190020-D050	●	5	7	0.9	4.4	35	19	0.7	0.2
JBCR07190020-D068	●	6.8	7	2.8	6.3	35	19	0.7	0.2

● : Line up

Reference pages

Standard cutting conditions → B393



Miniature Tool

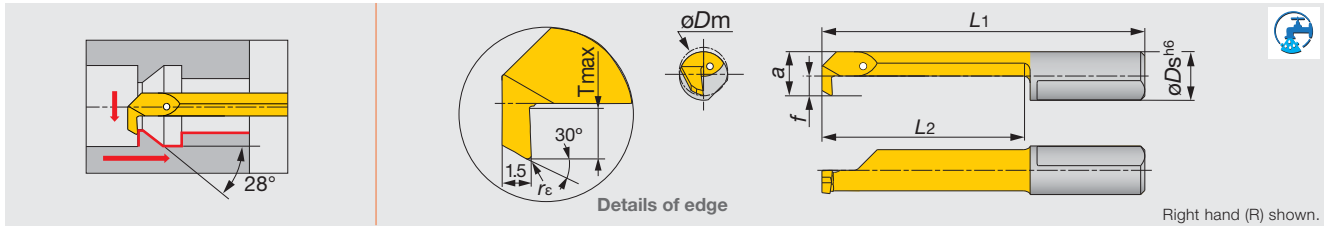

Metric	SH730	øDm	øDs	f	a	L1	L2	T max	r _e ^{+0.05}
JBBR04140020-D030	●	3	4	0.6	2.6	30	14	0.5	0.2
JBBR04190020-D030	●	3	4	0.6	2.6	35	19	0.5	0.2
JBBR04140015-D040	●	4	4	1.5	3.5	30	14	0.8	0.15
JBBR04240015-D040	●	4	4	1.5	3.5	40	24	0.8	0.15
JBBR07190020-D050	●	5	7	0.9	4.4	35	19	1	0.2
JBBR07290020-D050	●	5	7	0.9	4.4	45	29	1	0.2
JBBR07190020-D060	●	6	7	1.8	5.3	35	19	1.8	0.2
JBBR07290020-D060	●	6	7	1.8	5.3	45	29	1.8	0.2
JBBR07190020-D070	●	7	7	2.8	6.3	35	19	2.5	0.2
JBBR07290020-D070	●	7	7	2.8	6.3	45	29	2.5	0.2

● : Line up

Miniature Tool

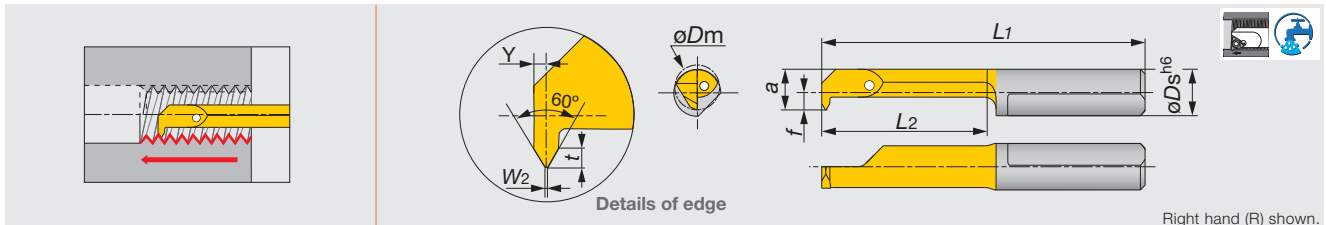

Metric	SH730	Pitch	øDm	W2. ⁰ / _{0.02}	øDs	f	a	L1	L2	t	Y
JBIR04140050-D040	●	0.5	4	0.06	4	1.5	3.5	30	14	0.3	0.35
JBIR07140050-D050	●	0.5	5	0.06	7	0.9	4.4	30	14	0.3	0.35
JBIR07140075-D050	●	0.75	5	0.09	7	0.9	4.4	30	14	0.4	0.45
JBIR07140100-D048	●	1	4.8	0.12	7	0.9	4.4	30	14	0.6	0.55
JBIR07140100-D060	●	1	6	0.12	7	1.8	5.3	30	14	0.6	0.55
JBIR07140125-D060	●	1.25	6	0.15	7	1.8	5.3	30	14	0.7	0.65
JBIR07140150-D060	●	1.5	6	0.18	7	1.8	5.3	30	14	0.8	0.75
JBIR07140150-D070	●	1.5	7	0.18	7	2.8	6.3	30	14	0.8	0.75

● : Line up

Reference pages

Standard cutting conditions → **B393**

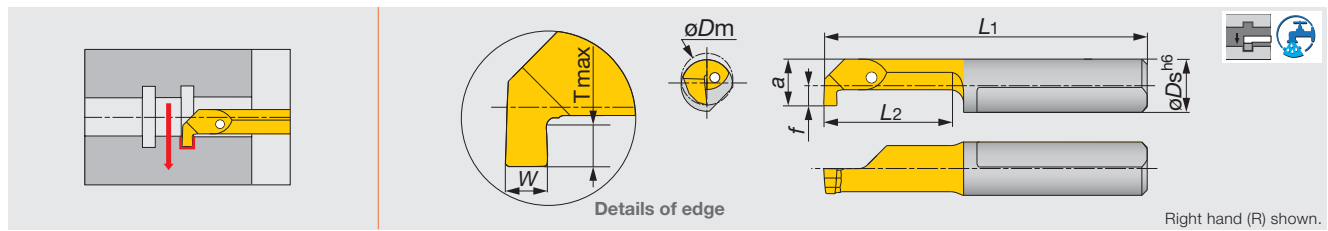

Metric	SH730	$W_0^{+0.05}$	ϕD_m	ϕD_s	f	a	L_1	L_2	T max
JBGR04050050-D020	●	0.5	2	4	0.2	1.8	21	5	0.4
JBGR04100050-D020	●	0.5	2	4	0.2	1.8	26	10	0.4
JBGR04050070-D030	●	0.7	3	4	0.7	2.7	21	5	0.6
JBGR04100070-D030	●	0.7	3	4	0.7	2.7	26	10	0.6
JBGR04090100-D040	●	1	4	4	1.5	3.5	25.5	9	0.8
JBGR04150100-D040	●	1	4	4	1.5	3.5	31.5	15	0.8
JBGR07090100-D050	●	1	5	7	0.9	4.4	25	9	1
JBGR07140100-D050	●	1	5	7	0.9	4.4	30	14	1
JBGR07090150-D050	●	1.5	5	7	0.9	4.4	25	9	1
JBGR07140150-D050	●	1.5	5	7	0.9	4.4	30	14	1
JBGR07090200-D050	●	2	5	7	0.9	4.4	25	9	1
JBGR07190200-D050	●	2	5	7	0.9	4.4	35	19	1
JBGR/L07090100-D060	●	1	6	7	1.8	5.3	25	9	1.8
JBGR07140100-D060	●	1	6	7	1.8	5.3	30	14	1.8
JBGR07210100-D060	●	1	6	7	1.8	5.3	37	21	1.8
JBGR07290100-D060	●	1	6	7	1.8	5.3	45	29	1.8
JBGR/L07090150-D060	●	1.5	6	7	1.8	5.3	25	9	1.8
JBGR07140150-D060	●	1.5	6	7	1.8	5.3	30	14	1.8
JBGR07210150-D060	●	1.5	6	7	1.8	5.3	37	21	1.8
JBGR07240150-D060	●	1.5	6	7	1.8	5.3	40	24	1.8
JBGR07290150-D060	●	1.5	6	7	1.8	5.3	45	29	1.8
JBGR07090200-D060	●	2	6	7	1.8	5.3	25	9	1.8
JBGR07140200-D060	●	2	6	7	1.8	5.3	30	14	1.8
JBGR07210200-D060	●	2	6	7	1.8	5.3	37	21	1.8
JBGR07240200-D060	●	2	6	7	1.8	5.3	40	24	1.8
JBGR07290200-D060	●	2	6	7	1.8	5.3	45	29	1.8
JBGR07090100-D068	●	1	6.8	7	2.7	6.2	25	9	2.5
JBGR07140100-D068	●	1	6.8	7	2.7	6.2	30	14	2.5
JBGR07210100-D068	●	1	6.8	7	2.7	6.2	37	21	2.5
JBGR07090150-D068	●	1.5	6.8	7	2.7	6.2	25	9	2.5
JBGR07140150-D068	●	1.5	6.8	7	2.7	6.2	30	14	2.5
JBGR07210150-D068	●	1.5	6.8	7	2.7	6.2	37	21	2.5
JBGR07290150-D068	●	1.5	6.8	7	2.7	6.2	45	29	2.5
JBGR07090200-D068	●	2	6.8	7	2.7	6.2	25	9	2.5
JBGR/L07140200-D068	●	2	6.8	7	2.7	6.2	30	14	2.5
JBGR07210200-D068	●	2	6.8	7	2.7	6.2	37	21	2.5
JBGR07250200-D068	●	2	6.8	7	2.7	6.2	40	25	2.5
JBGR07290200-D068	●	2	6.8	7	2.7	6.2	45	29	2.5

* Corner radius : less than 0.004".

● : Line up



Miniature Tool

Reference pages

Standard cutting conditions → **B394**

TINY^{INI}TURN

JBF R/L

Solid boring bars for face grooving

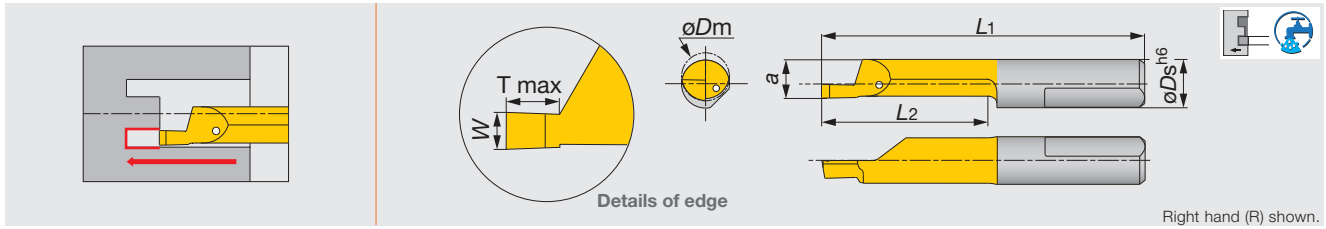

Right hand (R) shown.

Metric	SH730	$W_{0}^{+0.05}$	ϕD_m	ϕD_s	a	L1	L2	T max
JBFR07110100-D060	●	1	6	7	5.2	26	10	1.5
JBFR07110150-D060	●	1.5	6	7	5.2	26	10	2
JBFR07110200-D060	●	2	6	7	5.2	26	10	3
JBFR07110100-D080	●	1	8	7	5.9	27	11	1.5
JBFR07110150-D080	●	1.5	8	7	5.9	27	11	2.5
JBFR07110200-D080	●	2	8	7	5.9	27	11	3
JBFR07110250-D080	●	2.5	8	7	5.9	27	11	3.5
JBFR07110300-D080	●	3	8	7	5.9	27	11	3.5
JBFR/L07210150-D080	●	1.5	8	7	5.9	36	21	2.5
JBFR07210200-D080	●	2	8	7	5.9	36	21	3
JBFR07210250-D080	●	2.5	8	7	5.9	36	21	3.5
JBFR07210300-D080	●	3	8	7	5.9	36	21	3.5
JBFR/L07300200-D080	●	2	8	7	5.9	46	30	3
JBFR07300300-D080	●	3	8	7	5.9	46	30	3.5
JBFR07200200-D080	●	2	8	7	5.9	36	20	3
JBFR07200250-D150	●	2.5	15	7	5.9	36	20	20
JBFR07200300-D150	●	3	15	7	5.9	36	20	20
JBFR07300300-D150	●	3	15	7	5.9	46	30	30

* Corner radius : less than 0.004".

● : Line up

Miniature Tool

TINY^{INI}TURN

JBS R

Solid boring bars for face grooving (for shaft machining)

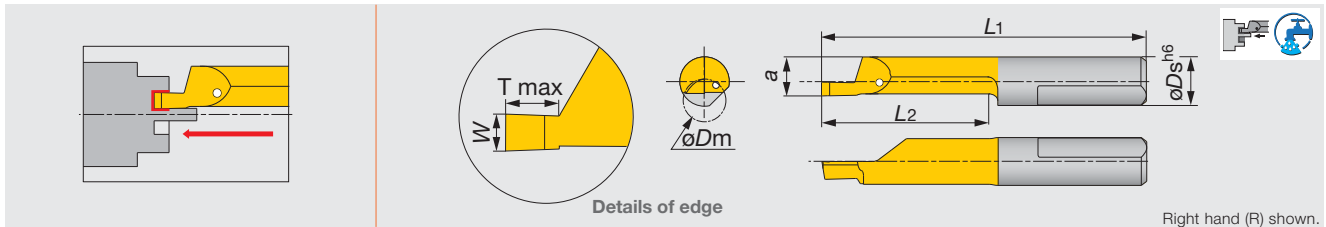

Right hand (R) shown.

Metric	SH730	$W_{0}^{+0.05}$	ϕD_m	ϕD_s	a	L1	L2	T max
JBRS07200200-D060	●	2	6	7	5.2	36	20	4

* Corner radius : less than 0.004".

● : Line up

Reference pages

Standard cutting conditions → B394

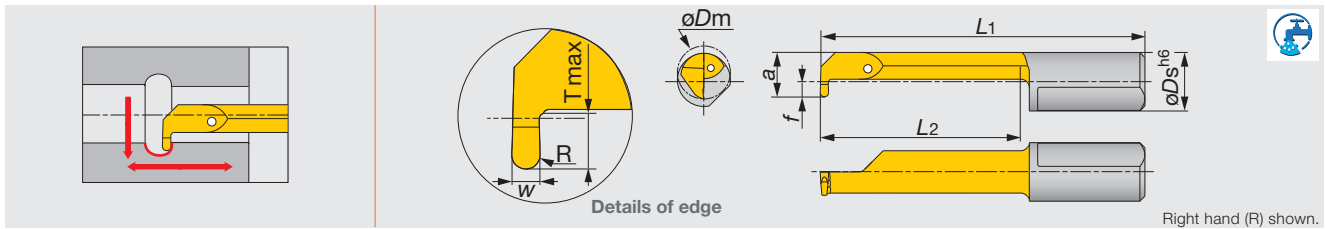

Metric	SH730	$W^{+0.05}_0$	ϕD_m	ϕD_s	f	a	L1	L2	T max	R
JBRR07190050-D050	●	1	5	7	0.9	4.4	35	19	1	0.5
JBRR07240050-D060	●	1	6	7	1.8	5.3	40	24	1.8	0.5
JBRR07290050-D068	●	1	6.8	7	2.8	6.3	45	29	2.5	0.5

● : Line up

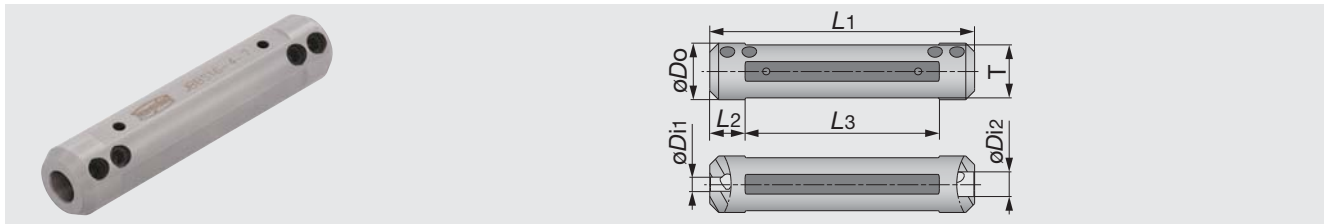

Metric	ϕD_o	ϕD_{i1}	ϕD_{i2}	L1	L2	L3	T
JBBS12-4-4	12	4	4	75	10	55	10.3
JBBS127-4-4	12.7 (0.500")	4	4	76.2	10	56.2	11.6
JBBS14-4-4	14	4	4	75	10	55	12
JBBS159-4-7	15.875 (0.625")	4	7	76.2	10	56.2	14
JBBS16-4-7	16	4	7	75	10	55	15
JBBS19-4-7	19.05 (0.750")	4	7	89	10	69	17.2
JBBS20-4-7	20	4	7	90	10	70	18
JBBS22-4-7	22	4	7	90	10	70	20
JBBS25-4-7	25	4	7	100	10	80	23
JBBS254-4-7	25.4 (1.000")	4	7	90	10	70	23.4

SPARE PARTS

Designation	Clamping screw	Wrench
JBBS12-4-4	SSHM5-4PF-S	P-2.5
JBBS127-4-4	SSHM5-6PF-S	P-2.5
JBBS14-4-4	SSHM5-4PF-S	P-2.5
JBBS*-4-7	SSHM5-6PF-S	P-2.5



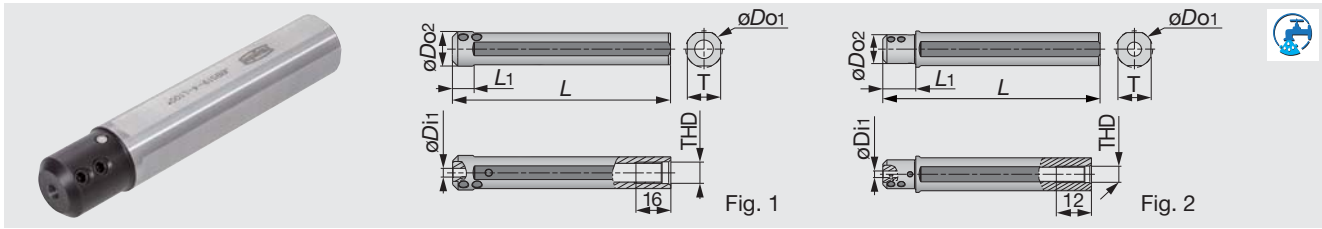

Metric	øDo1	øDo2	øDi1	L	L1	T	THD	Fig.
JBBS159-4-L100C	15.875 (0.625")	15.875	4	100	10	14.58	R1/8	1
JBBS159-7-L100C	15.875 (0.625")	15.875	7	100	10	14.58	R1/8	1
JBBS16-4-L100C	16	16	4	100	10	15	R1/8	1
JBBS16-7-L100C	16	16	7	100	10	15	R1/8	1
JBBS19-4-L100C	19.05 (0.750")	17.5	4	100	20	17.2	R1/8	2
JBBS19-7-L100C	19.05 (0.750")	17.5	7	100	20	17.2	R1/8	2
JBBS20-4-L100C	20	17.5	4	100	20	18	R1/8	2
JBBS20-7-L100C	20	17.5	7	100	20	18	R1/8	2
JBBS22-4-L100C	22	17.5	4	100	20	20	R1/8	2
JBBS22-7-L100C	22	17.5	7	100	20	20	R1/8	2
JBBS25-4-L100C	25	18	4	100	23	23	R1/8	2
JBBS25-7-L100C	25	18	7	100	23	23	R1/8	2
JBBS254-4-L100C	25.4	18	4	100	23	23.4	R1/8	2
JBBS254-7-L100C	25.4	18	7	100	23	23.4	R1/8	2

Miniature Tool

SPARE PARTS

Designation	Clamping screw	Wrench
JBBS**-4-L100C	SSHM5-6PF-S	P-2.5
JBBS**-7-L100C	SSHM5-4PF-S	P-2.5

STANDARD CUTTING CONDITIONS



Boring, profiling, chamfering, back boring

ISO	Workpiece material	Grade	Cutting speed Vc (sfm)	Feed f (ipr)
P	Low carbon steels 1015, 1025, etc.	SH730	300 (130 - 460)	0.002 (0.0004 - 0.003) (*)
	Carbon steels, Alloy steels 1055, 4140, etc.	SH730	300 (130 - 460)	0.002 (0.0004 - 0.003) (*)
	Prehardened steels NAK80, PX5, etc.	SH730	300 (130 - 460)	0.002 (0.0004 - 0.003) (*)
M	Stainless steels 304, 316, etc.	SH730	300 (130 - 460)	0.002 (0.0004 - 0.003) (*)
K	Grey cast irons No.250B, No.300B, etc.	SH730	200 (100 - 330)	0.002 (0.0004 - 0.003) (*)
	Ductile cast irons 65-45-12, 80-55-06, etc.	SH730	200 (100 - 330)	0.002 (0.0004 - 0.003) (*)
N	Aluminum alloys, copper alloys Si < 12%	SH730	490 (300 - 660)	0.002 (0.0004 - 0.003) (*)
S	Titanium alloys Ti-6Al-4V, etc.	SH730	200 (100 - 330)	0.002 (0.0004 - 0.003) (*)
	Superalloys Inconel718, etc.	SH730	200 (100 - 330)	0.002 (0.0004 - 0.003) (*)

* JBTR/L04020004-D006,
JBTR/L04030004-D006
Max. $f = 0.01$ mm/rev

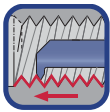

Threading (metric thread)

ISO	Workpiece material	Grade	Cutting speed Vc (sfm)	Number of passes Pitch (mm)				
				0.5 (0.020")	0.75 (0.029")	1.0 (0.039")	1.25 (0.049")	1.5 (0.059")
P	Low carbon steels 1015, 1025, etc.	SH730	460	6 - 8	8 - 10	10 - 12	12 - 15	15 - 18
	Carbon steels, Alloy steels 1055, 4140, etc.	SH730	460	6 - 8	8 - 10	10 - 12	12 - 15	15 - 18
	Prehardened steels NAK80, PX5, etc.	SH730	460	6 - 8	8 - 10	10 - 12	12 - 15	15 - 18
M	Stainless steels 304, 316, etc.	SH730	340	8	10	12	15	18
K	Grey cast irons No.250B, No.300B, etc.	SH730	380	7	9	12	14	17
	Ductile cast irons 65-45-12, 80-55-06, etc.	SH730	380	7	9	12	14	17
N	Aluminum alloys, copper alloys Si < 12%	SH730	1150	6	8	10	12	15



Miniature Tool

STANDARD CUTTING CONDITIONS



Internal grooving

ISO	Workpiece material	Grade	Cutting speed Vc (sfm)	Feed f (ipr)
P	Low carbon steels 1015, 1025, etc.	SH730	300 (130 - 460)	0.0008 (0.0004 - 0.0012)
	Carbon steels, Alloy steels 1055, 4140, etc.	SH730	300 (130 - 460)	0.0008 (0.0004 - 0.0012)
	Prehardened steels NAK80, PX5, etc.	SH730	300 (130 - 460)	0.0008 (0.0004 - 0.0012)
M	Stainless steels 304, 316, etc.	SH730	300 (130 - 460)	0.0008 (0.0004 - 0.0012)
K	Grey cast irons No.250B, No.300B, etc.	SH730	200 (100 - 330)	0.0008 (0.0004 - 0.0012)
	Ductile cast irons 65-45-12, 80-55-06, etc.	SH730	200 (100 - 330)	0.0008 (0.0004 - 0.0012)
N	Aluminum alloys, copper alloys Si < 12%	SH730	490 (300 - 660)	0.0008 (0.0004 - 0.0012)
S	Titanium alloys Ti-6Al-4V, etc.	SH730	200 (100 - 330)	0.0008 (0.0004 - 0.0012)
	Superalloys Inconel718, etc.	SH730	200 (100 - 330)	0.0008 (0.0004 - 0.0012)



Miniature Tool

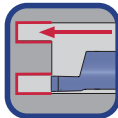

Face grooving

ISO	Workpiece material	Grade	Cutting speed Vc (sfm)	Feed f (ipr)
P	Low carbon steels 1015, 1025, etc.	SH730	300 (130 - 460)	0.0012 (0.0004 - 0.002)
	Carbon steels, Alloy steels 1055, 4140, etc.	SH730	300 (130 - 460)	0.0012 (0.0004 - 0.002)
	Prehardened steels NAK80, PX5, etc.	SH730	300 (130 - 460)	0.0012 (0.0004 - 0.002)
M	Stainless steels 304, 316, etc.	SH730	300 (130 - 460)	0.0012 (0.0004 - 0.002)
K	Grey cast irons 250, 300, etc.	SH730	200 (100 - 330)	0.0012 (0.0004 - 0.002)
	Ductile cast irons 65-45-12, 80-55-06, etc.	SH730	200 (100 - 330)	0.0012 (0.0004 - 0.002)
N	Aluminum alloys, copper alloys Si < 12%	SH730	490 (300 - 660)	0.0012 (0.0004 - 0.002)
S	Titanium alloys Ti-6Al-4V, etc.	SH730	200 (100 - 330)	0.0012 (0.0004 - 0.002)
	Superalloys Inconel718, etc.	SH730	200 (100 - 330)	0.0012 (0.0004 - 0.002)

MEMO

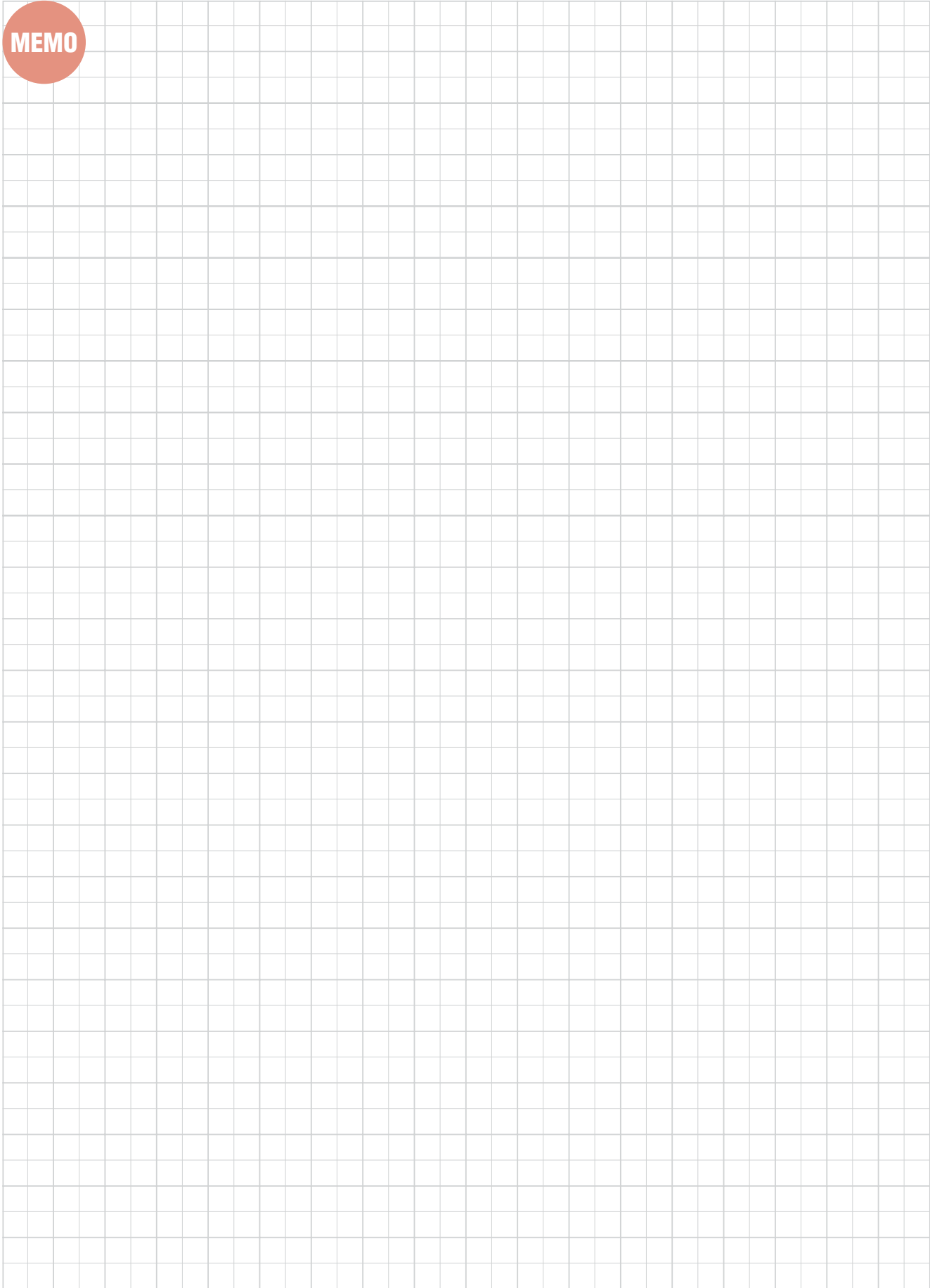

Miniature Tool

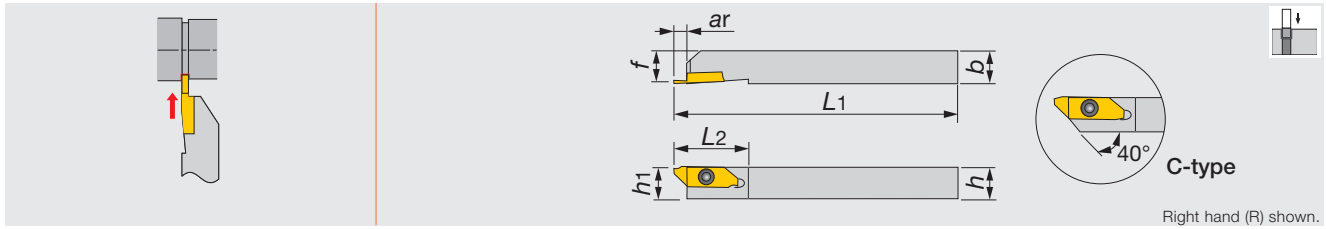

Metric	W	ar	h	b	L1	L2	h1	f	Insert
JSXGR/L1010K8-C	0.7 - 2	6.7	10	10	125	29	10	10	JX*R/L8...
JSXGR/L1212K8-C	0.7 - 2	6.7	12	12	125	29	12	12	JX*R/L8...
JSXGR/L1616K8	0.7 - 2	6.5	16	16	125	29	16	16	JX*R/L8...
JSXGR/L2020K8	0.7 - 2	6.5	20	20	125	29	20	20	JX*R/L8...
JSXGR/L2525K8	0.7 - 2	6.5	25	25	125	29	25	25	JX*R/L8...

- Can be wrenched also from the back with a double-head screw.
- This toolholders can be used for JXG insert (grooving), JXF insert (front-turning), JXK insert (reverse-turning).

SPARE PARTS

Designation	Clamping screw	Wrench	Wrench 1 (Optional parts)
JSXGR/L	CSTB-4SD	T-8F	(T-8L)

INSERT

JXG (handed insert with sharp edge)

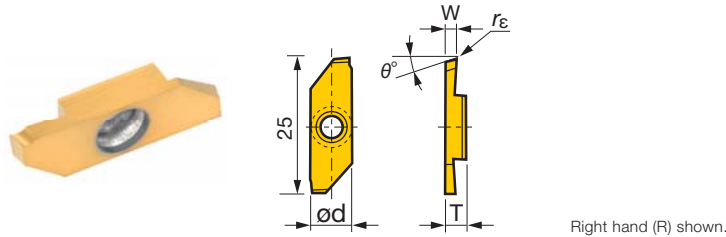

Designation	rε (mm)	Coated J740		Uncoated TH10		ød (mm)	T (mm)	W ^{+0.05} (mm)	θ°	Max. groove depth
		R	L	R	L					
JXGR/L8070FA	0	●	●	●	●	8	3.97	0.7	15	4.5
JXGR/L8070FA-005	0.05	●				8	3.97	0.7	15	4.5
JXGR/L8100FA	0	●	●	●	●	8	3.97	1	15	6
JXGR/L8100FA-005	0.05	●				8	3.97	1	15	6
JXGR/L8100FA45	0	●		●		8	3.97	1	15	4.5
JXGR/L8100FA45-005	0.05	●				8	3.97	1	15	4.5
JXGR/L8150FA	0	●	●	●	●	8	3.97	1.5	15	6
JXGR/L8150FA-005	0.05	●				8	3.97	1.5	15	6
JXGR/L8150FA50	0	●		●		8	3.97	1.5	15	5
JXGR/L8150FA50-005	0.05	●				8	3.97	1.5	15	5
JXGR/L8180FA	0	●		●		8	3.97	1.8	15	6
JXGR/L8180FA-005	0.05	●				8	3.97	1.8	15	6
JXGR/L8200FA	0	●	●	●	●	8	3.97	2	15	6
JXGR/L8200FA-005	0.05	●				8	3.97	2	15	6
JXGR/L8200FN	0	●	●	●	●	8	3.97	2	0	6
JXGR/L8200FN-005	0.05	●				8	3.97	2	0	6

● : Line up

Reference pages

Standard cutting conditions → **B398**

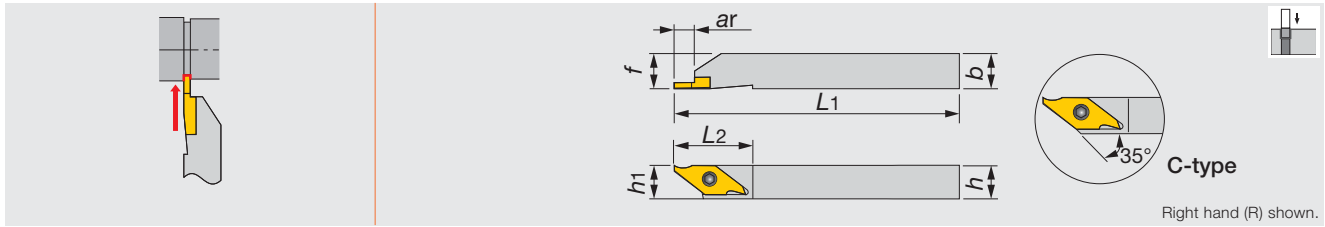

Right hand (R) shown.

Inch	W	ar	h	b	L1	L2	h1	f	Insert
JSVGR/L062.5	0.013 - 0.079	0.244	0.375	0.375	5.000	0.875	0.375	0.375	JVGR/L...
JSVGR/L082.5	0.013 - 0.079	0.244	0.500	0.500	5.000	0.875	0.500	0.500	JVGR/L...
JSVGR/L102.5	0.013 - 0.079	0.244	0.625	0.625	5.000	0.875	0.625	0.625	JVGR/L...

Metric	W	ar	h	b	L1	L2	h1	f	Insert
JSVGR/L1010K-C	0.33 - 2	6.2	10	10	125	23	10	10	JVGR/L...
JSVGR/L1212K-C	0.33 - 2	6.2	12	12	125	23	12	12	JVGR/L...
JSVGR/L1616K	0.33 - 2	6.2	16	16	125	23	16	16	JVGR/L...

• Recommend clamping torque: 2.3 N·m

SPARE PARTS



Designation	Clamping screw	Wrench	Wrench 1 (Optional parts)
JSVGR/L	CSTB-3S	T-9F	(T-8L)



Miniature Tool

INSERT

JVG (handed insert with sharp edge)

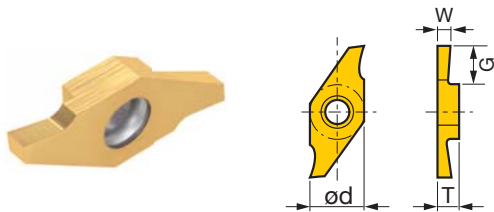

Right hand (R) shown.

Designation	Coated		Cermet		Uncoated		ød (mm)	T (mm)	W ^{+0.05} (mm)	G (mm)	Max. groove depth (mm)
	SH725	J740	NS9530	TH10	R	L					
JVGR/L033F	●	●	●				7.94	3.18	0.33	0.8	0.7
JVGR/L050F	●	●	●				7.94	3.18	0.5	1.2	1.1
JVGR/L075F	●	●	●				7.94	3.18	0.75	2	1.9
JVGR/L095F	●	●	●				7.94	3.18	0.95	2	1.9
JVGR/L100F	●	●	●	●	●	●	7.94	3.18	1	6	5.5
JVGR/L125F	●	●	●				7.94	3.18	1.25	5.5	5
JVGR/L150F	●	●	●	●	●	●	7.94	3.18	1.5	6	5.5
JVGR/L200F	●	●	●	●			7.94	3.18	2	6	5.5

● : Line up

Reference pages

Standard cutting conditions → **B398**

STANDARD CUTTING CONDITIONS (JXG type, JVG type insert)

ISO	Workpiece material	Grade	Cutting speed Vc (sfm)	Feed f (ipr)
P	General steel 1045, etc.	SH725	164 - 656	0.0004 - 0.004
		J740	33 - 328	0.0004 - 0.004
		NS9530	164 - 492	0.0004 - 0.004
	Free-cutting steel	SH725	164 - 656	0.0004 - 0.004
		J740	33 - 328	0.0004 - 0.004
M	Stainless steel 303, etc.	SH725	164 - 656	0.0004 - 0.004
		J740	33 - 328	0.0004 - 0.004
		NS9530	164 - 492	0.0004 - 0.004
N	Aluminum alloys, Brass 5056, 6061, etc.	TH10	33 - 656	0.0004 - 0.004
S	Difficult-to-machine material, Titanium alloys Ti-6Al-4V, etc.	TH10	33 - 98	0.0004 - 0.004



Miniature Tool

J-SERIES

JSTGR/L

External grooving toolholders

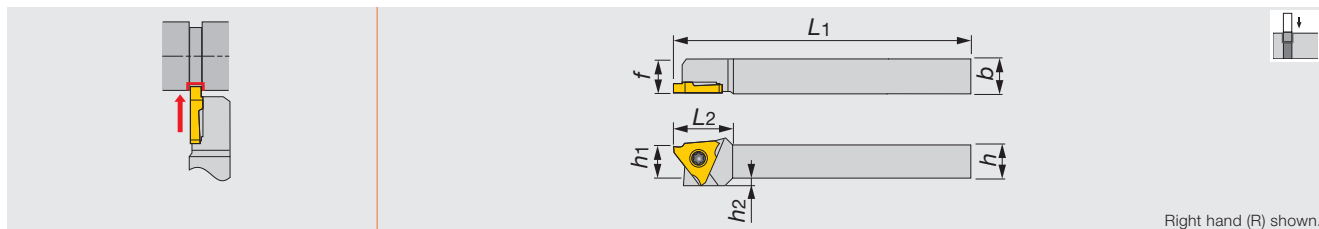

Right hand (R) shown.

Inch	W	h	b	L1	L2	h1	f	h2	Insert
JSTGR/L063	0.013 - 0.118	0.375	0.375	5.000	0.750	0.375	0.375	0.100	JTGR/L3...
JSTGR/L083	0.013 - 0.118	0.500	0.500	5.000	0.750	0.500	0.500	-	JTGR/L3...
JSTGR/L103	0.013 - 0.118	0.625	0.625	5.000	0.750	0.625	0.625	-	JTGR/L3...

Metric	W	h	b	L1	L2	h1	f	h2	Insert
JSTGR/L1010X3	0.33 - 3	10	10	120	18.5	10	10	2	JTGR/L3...
JSTGR/L1212F3	0.33 - 3	12	12	85	18.5	12	12	-	JTGR/L3...
JSTGR/L1212X3	0.33 - 3	12	12	120	18.5	12	12	-	JTGR/L3...
JSTGR/L1616X3	0.33 - 3	16	16	120	18.5	16	16	-	JTGR/L3...
JSTGL1616K3	0.33 - 3	16	16	125	18.5	16	16	-	JTGR/L3...

• Recommend clamping torque: 1.2 N-m

SPARE PARTS

Designation	Clamping screw	Wrench	Wrench 1 (Optional parts)
JSTGR/L...	CSTB-4SD	T-8F	(T-8L)



Miniature Tool

J-SERIES

JS-TGL3

External grooving toolholders

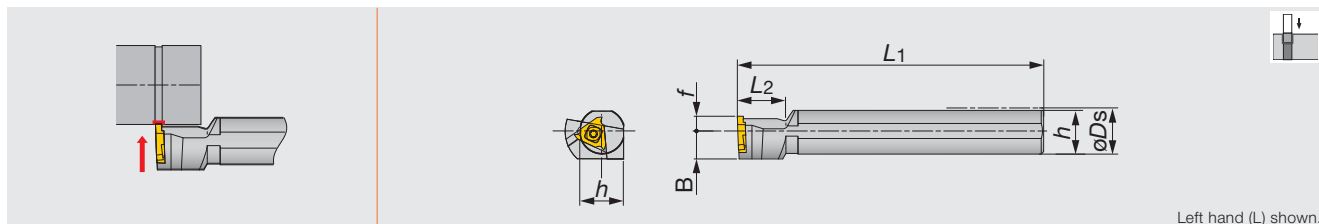

Left hand (L) shown.

Metric	W	øDs	f	L1	L2	h	B	Insert
JS19K-TGL3	0.33 - 3	19.05	6	125	20	18	11.5	JTGR3...
JS20K-TGL3	0.33 - 3	20	6	125	20	19	11.5	JTGR3...
JS22K-TGL3	0.33 - 3	22	6	125	20	21	11.5	JTGR3...
JS25K-TGL3	0.33 - 3	25.4	10	125	20	24	12.7	JTGR3...

• Left hand toolholders (TGL3) are used with right hand inserts (JTGR3). • Recommend clamping torque: 3.0 N-m

SPARE PARTS

Designation	Clamping screw	Wrench
JS**-TGL3	CSTB-4S	T-15F

Reference pages

JSTGR/L, JS-TGL3: Inserts → B400 -, Standard cutting conditions → B401

INSERT

JTG (sharp edge)

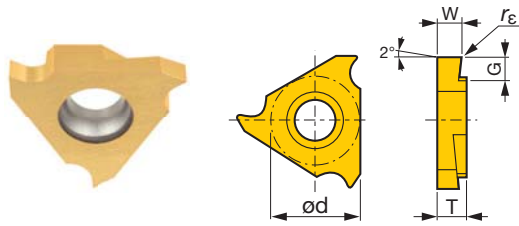

Right hand (R) shown.

Designation	W ^{+0.05} (mm)	rε (mm)	Coated		Cermet		Uncoated		ød (mm)	T (mm)	G (mm)	Max. groove depth (mm)
			SH725	J740	NS9530	TH10						
			R	L	R	L	R	L				
JTGR/L3033F	0.33	0.03	●		●	●			9.525	3.18	0.8	0.7
JTGR/L3033F-005	0.33	0.05	●						9.525	3.18	0.8	0.7
JTGR/L3043F	0.43	0.03			●				9.525	3.18	1.2	1.1
JTGR/L3050F	0.5	0.03	●	●	●	●	●	●	9.525	3.18	1.2	1.1
JTGR/L3050F-005	0.5	0.05	●	●					9.525	3.18	1.2	1.1
JTGR/L3065F	0.65	0.03	●		●				9.525	3.18	2	1.9
JTGR/L3065F-010	0.65	0.1	●						9.525	3.18	2	1.9
JTGR/L3075F	0.75	0.03	●	●	●	●	●	●	9.525	3.18	2	1.9
JTGR/L3075F-010	0.75	0.1	●	●					9.525	3.18	2	1.9
JTGR/L3080F	0.8	0.03	●		●				9.525	3.18	2	1.9
JTGR/L3080F-010	0.8	0.1	●						9.525	3.18	2	1.9
JTGR/L3085F	0.85	0.03	●		●				9.525	3.18	2	1.9
JTGR/L3095F	0.95	0.03	●	●	●	●	●	●	9.525	3.18	2	1.9
JTGR/L3095F-010	0.95	0.1	●	●					9.525	3.18	2	1.9
JTGR/L3100F	1	0.05	●	●	●	●	●	●	9.525	3.18	2.2	2.1
JTGR/L3100F-010	1	0.1	●	●					9.525	3.18	2.2	2.1
JTGR/L3110F	1.1	0.05	●		●				9.525	3.18	2.2	2.1
JTGR/L3120F	1.2	0.05	●		●				9.525	3.18	2.2	2.1
JTGR/L3120F-010	1.2	0.1	●						9.525	3.18	2.2	2.1
JTGR/L3125F	1.25	0.05	●	●	●	●	●	●	9.525	3.18	2.2	2.1
JTGR/L3125F-010	1.25	0.1	●	●					9.525	3.18	2.2	2.1
JTGR/L3130F	1.3	0.05	●		●				9.525	3.18	2.2	2.1
JTGR/L3140F	1.4	0.05	●		●				9.525	3.18	2.2	2.1
JTGR/L3140F-010	1.4	0.1	●						9.525	3.18	2.2	2.1
JTGR/L3145F	1.45	0.05	●		●	●	●	●	9.525	3.18	2.2	2.1
JTGR/L3145F-010	1.45	0.1	●						9.525	3.18	2.2	2.1
JTGR/L3150F	1.5	0.05	●	●	●	●	●	●	9.525	3.18	2.2	2.1
JTGR/L3150F-010	1.5	0.1	●	●					9.525	3.18	2.2	2.1
JTGR/L3175F	1.75	0.05	●		●	●	●	●	9.525	3.18	2.2	2.1
JTGR/L3175F-010	1.75	0.1	●						9.525	3.18	2.2	2.1
JTGR/L3180F	1.8	0.05	●		●				9.525	3.18	2.2	2.1
JTGR/L3200F	2	0.05	●	●	●	●	●	●	9.525	3.18	2.7	2.6
JTGR/L3200F-010	2	0.1	●	●					9.525	3.18	2.7	2.6
JTGR/L3225F	2.25	0.05	●		●				9.525	3.18	2.7	2.6
JTGR/L3250F	2.5	0.05	●	●	●	●	●	●	9.525	3.18	2.7	2.6
JTGR/L3250F-010	2.5	0.1	●	●					9.525	3.18	2.7	2.6
JTGR/L3275F	2.75	0.05			●				9.525	3.18	2.7	2.6
JTGR/L3300F	3	0.05	●		●				9.525	3.18	2.7	2.6
JTGR/L3300F-010	3	0.1	●						9.525	3.18	2.7	2.6

● : Line up



Miniature Tool

JTG (with honing)

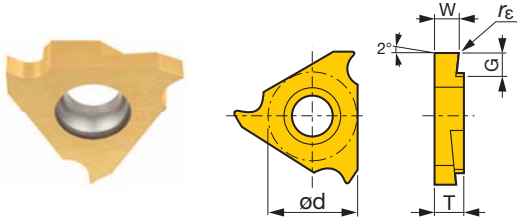

Right hand (R) shown.

Designation	$r\epsilon$ (mm)	Coated cermet J9530		ϕd (mm)	T (mm)	$W_{0.05}^{+0.05}$ (mm)	G (mm)	Max. groove depth (mm)
		R	L					
JTGR/L3100	0.05	●		9.525	3.18	1	2.2	2.1
JTGR/L3125	0.05	●		9.525	3.18	1.25	2.2	2.1
JTGR/L3150	0.05	●		9.525	3.18	1.5	2.2	2.1
JTGR/L3200	0.05	●		9.525	3.18	2	2.7	2.6

● : Line up

STANDARD CUTTING CONDITIONS (JTGR type insert)

ISO	Workpiece material	Grade	Cutting speed V_c (sfm)	Feed f (ipr)
P	General steel 1045, etc.	SH725	164 - 656	0.0004 - 0.004
		J740	33 - 328	0.0004 - 0.004
		NS9530	164 - 492	0.0004 - 0.004
		J9530	164 - 492	0.0004 - 0.004
	Free-cutting steel	SH725	164 - 656	0.0004 - 0.004
		J740	33 - 328	0.0004 - 0.004
M	Stainless steel 303, etc.	SH725	164 - 656	0.0004 - 0.004
		J740	33 - 328	0.0004 - 0.004
		NS9530	164 - 492	0.0004 - 0.004
		J9530	164 - 492	0.0004 - 0.004
N	Aluminum alloys, Brass Si < 12%	TH10	33 - 656	0.0004 - 0.004
S	Difficult-to-machine material, Titanium alloys Ti-6Al-4V, etc.	TH10	33 - 656	0.0004 - 0.004



Miniature Tool

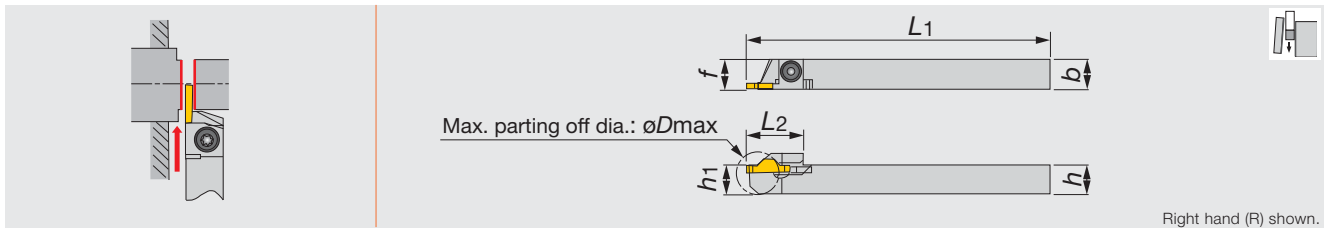

Right hand (R) shown.

Inch	W	øDmax	h	b	L1	L2	h1	f	Insert
JCCWSR/L062	0.079	0.790	0.375	0.375	5.000	0.748	0.375	0.1875	JCC*200F...
JCCWSR/L082	0.079	0.790	0.500	0.500	5.000	0.748	0.500	0.250	JCC*200F...
JCCWSR/L102	0.079	0.790	0.625	0.625	5.000	0.748	0.625	0.3125	JCC*200F...

Metric	W	øDmax	h	b	L1	L2	h1	f	Insert
JCCWSR/L1010K2	2	20	10	10	125	19	10	10	JCC*200F...
JCCWSR/L1212K2	2	20	12	12	125	19	12	12	JCC*200F...
JCCWSR/L1616K2	2	20	16	16	125	19	16	16	JCC*200F...
JCCWSR/L2020K2	2	20	20	20	125	19	20	20	JCC*200F...
JCCWSR/L2525K2	2	20	25	25	125	19	25	25	JCC*200F...

SPARE PARTS



Designation	Clamping screw	Wrench	Wrench 1 (Optional parts)
JCCWSR/L...	CSTB-4S	T-15F	(T-15L)



Miniature Tool

INSERT

JCC (sharp edge)

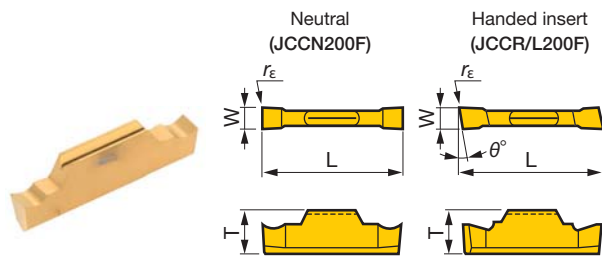

Right hand (R) shown.

Designation	rε (mm)	Coated		Uncoated		T (mm)	W (mm)	L (mm)	θ°
		J740	TH10	J740	TH10				
JCCN200F	0	●	●			4.8	2	15	-
JCCN200F-005	0.05	●				4.8	2	15	-
JCCR/L200F	0	●		●	●	4.8	2	15	15
JCCR/L200F-005	0.05	●		●		4.8	2	15	15

● : Line up

Reference pages

Standard cutting conditions → **B403**

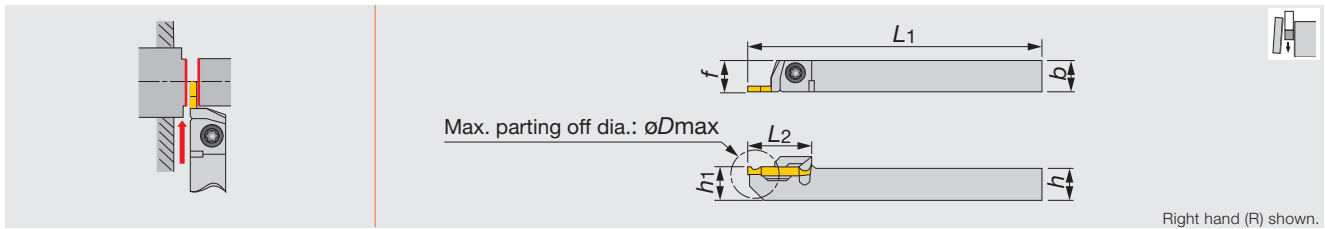

Right hand (R) shown.

Metric	W	øDmax	h	b	L1	L2	h1	f	Insert
JCGWSR/L1010K2	2	20	10	10	125	20	10	10	JCGN200F...
JCGWSR/L1212K2	2	20	12	12	125	20	12	12	JCGN200F...
JCGWSR/L1616K2	2	20	16	16	125	20	16	16	JCGN200F...

SPARE PARTS

Designation	Clamping screw	Wrench	Wrench 1 (Optional parts)
JCGWSR/L...	CSTB-4S	T-15F	(T-15L)

INSERT

JCG (sharp edge)

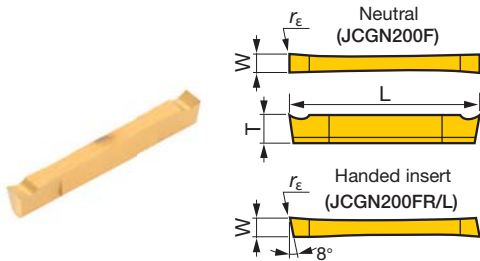

Right hand (R) shown.

Designation	rε (mm)	Coated J740			Uncoated TH10			T (mm)	W (mm)	L (mm)
		R	N	L	R	N	L			
JCGN200F	0.05		●		●		3	2	20	
JCGN200FR/L	0.05	●		●	●		3	2	20	

● : Line up

STANDARD CUTTING CONDITIONS (JCC type, JCG type insert)

ISO	Workpiece material	Grade	Cutting speed Vc (sfm)	Feed f (ipr)
P	General steel 1045, etc.	J740	33-328	0.0004 - 0.004
	Free-cutting steel	J740	33-328	0.0004 - 0.004
M	Stainless steel 303, etc.	J740	33-328	0.0004 - 0.004
N	Aluminum alloys, Brass Si < 12%	TH10	33 - 656	0.0004 - 0.004
S	Difficult-to-machine material, Titanium alloys Ti-6Al-4V, etc.	TH10	33 - 98	0.0004 - 0.004



Miniature Tool

MY-T SERIES

JCGSSR/L

External grooving & parting-off toolholders

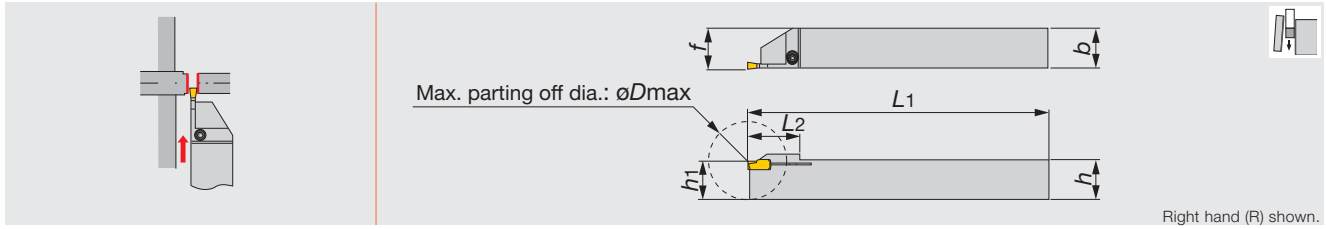

Right hand (R) shown.

Metric	W	øDmax	h	b	L1	L2	h1	f	Insert
JCGSSR/L1010-20	2	20	10	10	125	15	10	10.2	GE20...
JCGSSR/L1212-20	2	25	12	12	125	19	12	12.2	GE20...
JCGSSR/L1616-20	2	32	16	16	125	22.5	16	16.2	GE20...

SPARE PARTS

Designation	Clamping screw	Wrench
JCGSSR/L...	CSTB-3	T-9F

INSERT

GE20

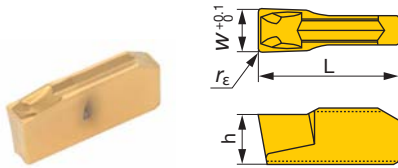

Designation	rε (mm)	Coated		W (mm)	L (mm)	h (mm)
		GH730	NS9530			
GE20	0.2	●	●	2	10	3.5

● : Line up

For aluminium and non-ferrous metals

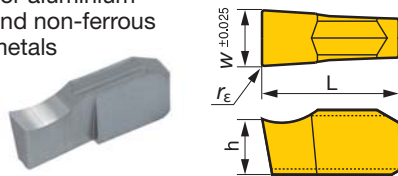

Designation	rε (mm)	Uncoated		W (mm)	L (mm)	h (mm)
		KS05F				
GE20-AL	0.2	●		2	10	3.5

● : Line up

Reference pages

Standard cutting conditions → B405

STANDARD CUTTING CONDITIONS (GE type insert)

ISO	Workpiece material	Grade	Cutting speed Vc (sfm)	Feed f (ipr)
P	Low carbon steels Alloy steels (~ 150HB)	NS9530	326 - 656	0.002 - 0.006
		GH730	164 - 591	0.002 - 0.006
	Medium carbon steels Alloy steels (150 ~ 250HB)	NS9530	262 - 591	0.002 - 0.006
		GH730	164 - 591	0.002 - 0.006
	High carbon steels Alloy steels (250HB ~)	NS9530	262 - 591	0.002 - 0.006
		GH730	164 - 394	0.002 - 0.006
M	Stainless steels	GH730	164 - 394	0.002 - 0.006
K	Gray and ductile cast irons	GH730	164 - 591	0.002 - 0.006
N	Aluminum alloys Non-ferrous metals	KS05F	658 - 984	0.001 - 0.004



Miniature Tool

J-SERIES

JSTTR/L

External threading toolholders

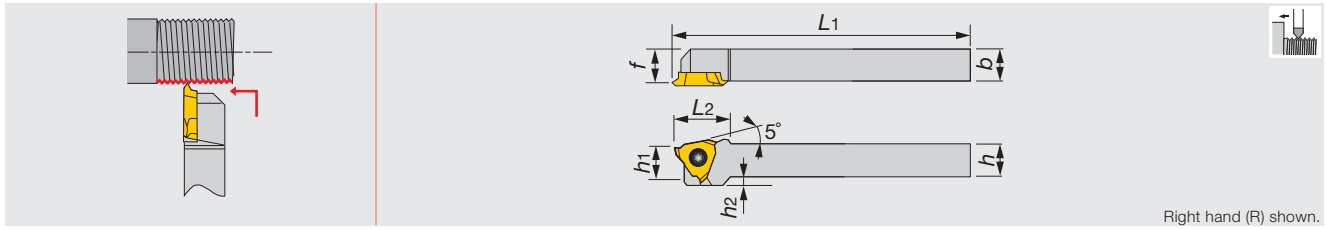

Right hand (R) shown.

Inch	<i>h</i>	<i>b</i>	<i>L</i> ₁	<i>L</i> ₂	<i>h</i> ₁	<i>f</i>	<i>h</i> ₂	Insert
JSTTR/L063	0.375	0.375	5.000	0.6875	0.375	0.375	0.100	JTTR/L3...
JSTTR/L083	0.500	0.500	5.000	0.6875	0.500	0.500	0.100	JTTR/L3...
JSTTR/L103	0.625	0.625	5.000	0.6875	0.625	0.625	0.100	JTTR/L3...

Metric	<i>h</i>	<i>b</i>	<i>L</i> ₁	<i>L</i> ₂	<i>h</i> ₁	<i>f</i>	<i>h</i> ₂	Insert
JSTTR/L1010X3	10	10	120	18.5	10	9.5	2	JTTR/L3...
JSTTR/L1212F3	12	12	85	18.5	12	11.5	-	JTTR/L3...
JSTTR/L1212X3	12	12	120	18.5	12	11.5	-	JTTR/L3...
JSTTR/L1616X3	16	16	120	18.5	16	15.5	-	JTTR/L3...

• Recommend clamping torque: 1.2 N·m

SPARE PARTS

Designation	Clamping screw	Wrench	Wrench 1 (Optional parts)
JSTTR/L...	CSTB-4SD	T-8F	(T-8L)



Miniature Tool

J-SERIES

JS-TTL3

External threading toolholders

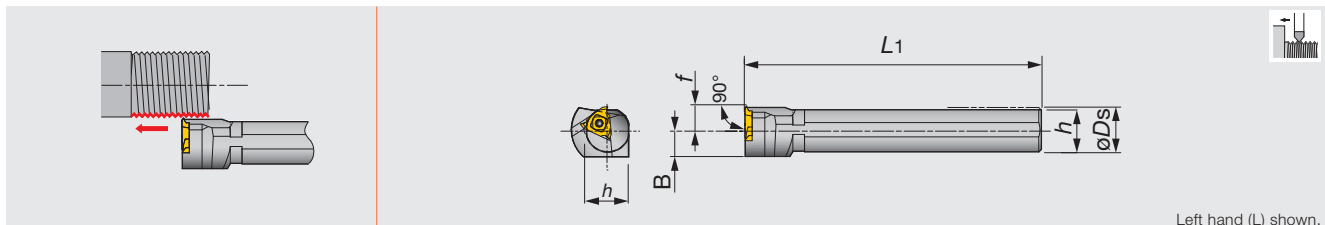

Left hand (L) shown.

Metric	ϕD_s	<i>f</i>	<i>L</i> ₁	<i>h</i>	<i>B</i>	Insert
JS19K-TTL3	19.05	10	125	18	11.5	JTTR30...
JS20K-TTL3	20	10	125	19	11.5	JTTR30...
JS22K-TTL3	22	10	125	21	11.5	JTTR30...
JS25K-TTL3	25.4	10	125	24	12.7	JTTR30...

• Recommend clamping torque: 3.5 N·m

SPARE PARTS

Designation	Clamping screw	Wrench
JS*-TTL3	CSTB-4S	T-15F

Reference pages

JSTTR/L, JS-TTL3: Inserts → B407

INSERT

JTT (sharp edge)

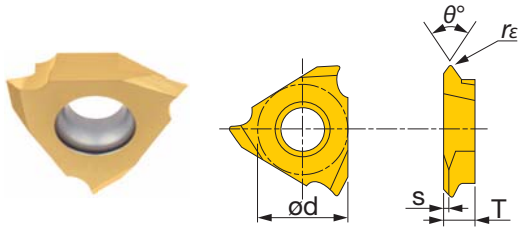

Right hand (R) shown.

Designation	r_ϵ (mm)	Coated				Cermet		Uncoated		θ°	ϕd (mm)	T (mm)	s (mm)
		SH725		J740		NS9530		TH10					
		R	L	R	L	R	L	R	L				
JTTR/L3005F-55	0.05	●		●						55	9.525	3.18	0.6
JTTR/L3005F	0.05	●	●	●		●		●		60	9.525	3.18	0.9
JTTR/L3010F	0.1	●	●	●		●		●		60	9.525	3.18	0.9

Machinable pitch range: 0.5 to 1 mm

● : Line up



Miniature Tool

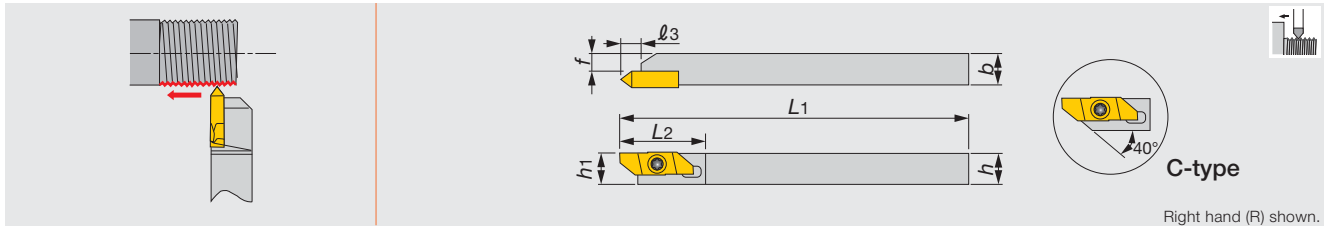

Metric	<i>h</i>	<i>b</i>	<i>L1</i>	<i>L2</i>	<i>ℓ3</i>	<i>h1</i>	<i>f</i>	Insert
JSXBR1010K8-C	10	10	125	29	6.4	10	5.7	JXT*R...
JSXBR1212K8-C	12	12	125	29	6.4	12	7.7	JXT*R...
JSXBR1616K8	16	16	125	29	6.4	16	11.7	JXT*R...
JSXBR2020K8	20	20	125	29	6.4	20	15.7	JXT*R...
JSXBR2525K8	25	25	125	29	6.4	25	20.7	JXT*R...

- Can be wrenched from back side with both end torx screw.
- This toolholder is compatible with JXB-type inserts and JXT-type inserts.

SPARE PARTS

Designation	Clamping screw	Wrench	Wrench 1 (Optional parts)
JSXBR...	CSTB-4SD	T-8F	(T-8L)

INSERT

JXT (sharp edge)

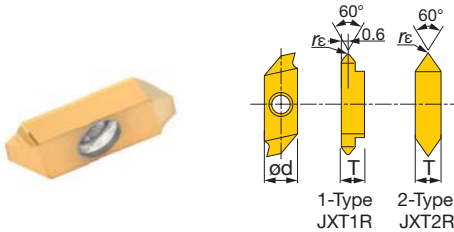

Designation	<i>rε</i> (mm)	Coated	Uncoated	θ°	ϕd (mm)	T (mm)
		J740	TH10			
JXT1R6000F	0.03	●	●	60	8	3.97
JXT2R6000F	0.03	●	●	60	8	3.97

Machinable pitch range: 0.5 to 1 mm

● : Line up

TUNGTHREAD

B-S/CER/L

External threading toolholders

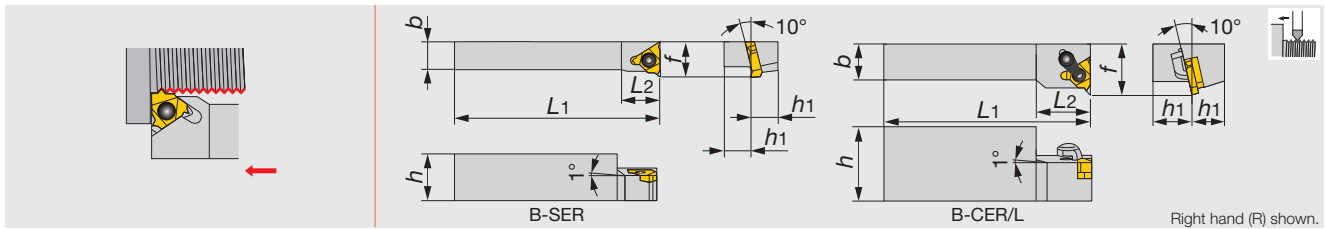

Metric	h	b	L_1	L_2	h_1	f	Insert
B-SER10H16	20	10	100	15	10	16	16ER/L...
B-SER12K16	24	12	125	18	12	18	16ER/L...
B-CER/L16M16	32	16	150	24	16	22	16ER/L...

SPARE PARTS

Designation	Clamp set	Shim set	Clamping screw	Wrench
B-SER**16	-	-	CSTB-3.5	T-15F
B-CER/L16M16	CSP16	A16-1	-	T-15F

TUNGTHREAD

BC-SER

External threading toolholders

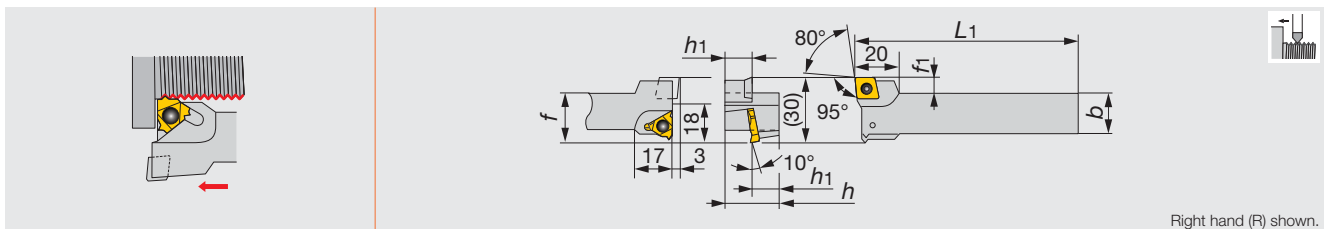

Metric	h	b	L_1	h_1	f	f_1	Insert
BC-SER12K16	24	16	125	12	23	7	16ER/L..., CC*T09T3...

SPARE PARTS

Designation	Clamping screw	Wrench
BC-SER**16	CSTB-3.5	T-15F

● Tooling examples using BC-type toolholders

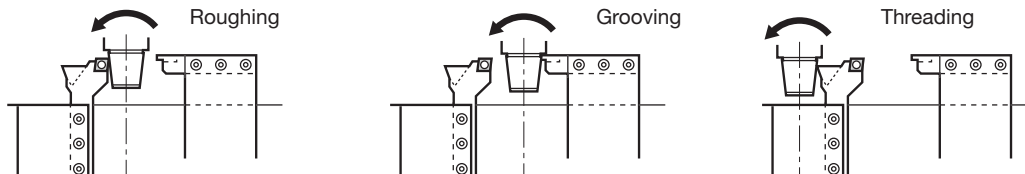

Reference pages

B-S/CER/L: Inserts → **B418 -**, Standard cutting conditions → **B416**

BC-SER: Inserts → **B106 -** (CC*T09T3...), **B418 -** (16ER/L...),
PCD → **B179**, Standard cutting conditions → **B416**

Miniature Tool

TurnLine - Threading



TUNGTHREAD

Inserts and toolholders for threading

B418

Inch Metric



Threading Tool for Oil and Gas

Tool series for threading oil well goods

B463



TungThread

Tungaloy B411

Thread type	Partial profile		Full profile				
	60°	55°	ISO metric	Unified	Whitworth	Parallel pipe thread	Taper pipe thread
	-	-	M	UNC, UNF UNEF	BSW, BSF W	G BSP, PF	R, PT, BSPT
Thread form							
Tool type							
ST type B432	0.5 ~ 6 mm 48 ~ 4 TPI B418	0.5 ~ 5 mm 48 ~ 5 TPI B419	0.5 ~ 6 mm B420	32 ~ 5 TPI B422	28 ~ 5 TPI B424		28 ~ 11 TPI B425
TETRAMCUT STCR/L-18 B457	0.8 ~ 3 mm 32 ~ 8 TPI B459	—	—	—	—	—	—
TETRAMCUT JS-STCL18 B458	0.8 ~ 3 mm 32 ~ 8 TPI B459	—	—	—	—	—	—
TT-R/L B456	~ 3 mm ~ 8 TPI B455	~ 3 mm ~ 8 TPI B455	—	—	—	—	—
JSTTR/L B460	0.5 ~ 1 mm 48 ~ 25 TPI B461	0.5 ~ 1 mm 48 ~ 25 TPI B461	—	—	—	—	—
JS-TTL3 B460	0.5 ~ 1 mm 48 ~ 25 TPI B461	0.5 ~ 1 mm 48 ~ 25 TPI B461	—	—	—	—	—
JSXBR/L B462	0.5 ~ 1 mm 48 ~ 25 TPI B462	—	—	—	—	—	—
TUNGST-CLAMP C021	1.27 ~ 4.23 mm 20 ~ 6 TPI C026	—	—	—	—	—	—

The page number for the product details is shown in red.

Thread type	Full profile				
	National taper pipe		30° Trapezoidal	DIN 405 Round	UNJ
	NPT	NPTF	TR	Rd	UNJC,UNJF
Thread form					
Tool type					
ST type 	27 ~ 8 TPI	27 ~ 8 TPI	1.5 ~ 6 mm	8 TPI, 6 TPI	32 ~ 8 TPI
B432	B426	B427	B428	B430	B430
Chaser 	11.5 TPI, 8 TPI	—	—	—	—
B470	B470				

Thread type	Full profile						
	API Tubing & Casing		API Rotary Shoulder Connection			ACME	STUB ACME
	Round	Buttress	V-0.038R	V-0.040	V-0.050		
Thread form							
Tool type							
ST type 	10 TPI, 8 TPI	5 TPI (0.75 TPF)	—	—	—	12 ~ 5 TPI	—
B432	B429	B429				B428	
Lay down (Single side) 	—	5 TPI (0.75 TPF) 5 TPI (1 TPF)	—	—	—	—	—
B463		B464					
Lay down (Double side) 	—	—	4 TPI (2 TPF) 4 TPI (3 TPF)	5 TPI (3 TPF)	4 TPI (2 TPF) 4 TPI (3 TPF)	—	—
B465			B466	B466	B466		
On edge 	10 TPI, 8 TPI	5 TPI (0.75 TPF) 5 TPI (1 TPF)	—	—	—	16 ~ 3 TPI	16 ~ 3 TPI
B467	B469	B469				B469	B469
Chaser 	10 TPI, 8 TPI	5 TPI (0.75 TPF)	—	—	—	—	—
B470	B470	B470					

The page number for the product details is shown in red.

Thread type	Partial profile		Full profile				
	60°	55°	ISO metric	Unified	Whitworth	Parallel pipe thread	Taper pipe thread
	-	-	M	UNC, UNF UNEF	BSW, BSF W	G, Rp BSP, PF, PS	Rc, PT, BSPT
Thread form							
Tool type							
B434	0.5 ~ 6 mm 48 ~ 4 TPI B418	0.5 ~ 5 mm 48 ~ 5 TPI B419	0.5 ~ 6 mm B420	32 ~ 5 TPI B422	28 ~ 5 TPI B424	B425	
B456	~ 3 mm ~ 8 TPI B455	~ 3 mm ~ 8 TPI B455	—	—	—	—	—
C024	2.11 ~ 5.08 mm 12 ~ 5 TPI C026	—	—	—	—	—	—

Threading Tool

Thread type	Full profile			
	National taper pipe		30° Trapezoidal	DIN 405 Round
	NPT	NPTF	TR	Rd
Thread form				
Tool type				
B434	27 ~ 8 TPI B426	14 ~ 8 TPI B427	1.5 ~ 5 mm B428	6 TPI B430
B471	11.5 TPI, 8 TPI B471	—	—	—

The page number for the product details is shown in red.

Thread type	Full profile						
	API Tubing & Casing		API Rotary Shoulder Connection			ACME	STUB ACME
	Round	Buttress	V-0.038R	V-0.040	V-0.050		
Thread form							
Tool type							
ST type B434	10 TPI, 8 TPI B429	5 TPI (0.75 TPF) B429	—	—	—	12 ~ 5 TPI B428	—
Lay down (Single side) B464	—	5 TPI (0.75 TPF) 5 TPI (1 TPF) B464	—	—	—	—	—
Lay down (Double side) B466	—	—	4 TPI (2 TPF) 4 TPI (3 TPF) B466	5 TPI (3 TPF) B466	4 TPI (2 TPF) 4 TPI (3 TPF) B466	—	—
On edge B468	10 TPI, 8 TPI B469	5 TPI (0.75 TPF) 5 TPI (1 TPF) B469	—	—	—	—	—
Chaser B471	10 TPI, 8 TPI B471	5 TPI (0.75 TPF) B471	—	—	—	—	—

The page number for the product details is shown in red.

STANDARD CUTTING CONDITIONS

ISO	Workpiece material	Hardness	Cutting speed: Vc (sfm)			
			AH725	T313V	NS9530	TH10
P	Carbon steels	< 200HB	262 - 591	328 - 656	492 - 656	-
		> 200HB	197 - 525	328 - 492	656 - 558	-
M	Stainless steels	-	164 - 427	230 - 427	-	-
K	Cast irons	-	-	230 - 492	-	70 - 90
N	Non-ferrous metals	-	-	-	-	100 - 500
S	Heat-resisting alloys	-	-	-	-	10 - 40
H	Hard materials	50 ~ 60HRC	-	-	-	10 - 30

DESIGNATION SYSTEM FOR TAC INSERTS

16
I
R
175
ISO
-
B

1 Insert size		2 External or Internal		3 Hand of insert		4 Pitch (TPI)		5 Thread type		6 Chipbreaker	
Symbol	I. C. dia (in)	E	External	R	Right hand	Partial-profile inserts		Partial-profile inserts		B	With (Basic selection)
06	-	I	Internal	L	Left hand	A	Pitch: 0.5 ~ 1.5 mm (0.020" ~ 0.063") TPI: 48 ~ 16	60°	60° thread angle	M	With
11	0.250					AG	Pitch: 0.5 ~ 3 mm (0.020" ~ 0.125") TPI: 48 ~ 8	55°	55° thread angle	CB	With
16	0.375					G	Pitch: 1.75 ~ 3 mm (0.071" ~ 0.125") TPI: 14 ~ 8	TR	30° trapezoidal	-	Without
22	0.500					N	Pitch: 3.5 ~ 5 mm (0.142" ~ 0.200") TPI: 7 ~ 5	ACME	29° trapezoidal		
27	0.625					Z	Pitch: 4 ~ 6 mm (0.167" ~ 0.250") TPI: 6 ~ 4	Full-profile inserts			
							Full-profile inserts	ISO	Metric		
							pitch (mm)×10 or 100 TPI (Thread Per Inch) (Examples) 05: 0.5 mm pitch×10 175: 1.75 mm pitch×100 14: 14 TPI	UN	Unified		
								W	Whitworth		
								PT	Taper pipe		
								NPT	National taper pipe		
								NPTF	National taper pipe		
								RAPI	API round		
								RD			
								BAPI	API buttress		
								RD	Round (DIN405)		
								UNJ	UNJ		

Note: Please identify new designation system for internal inserts.
-i.e. "N" → "I"

(Example) Conventional: 16NR15ISO
New: 16I R15ISO

MEMO

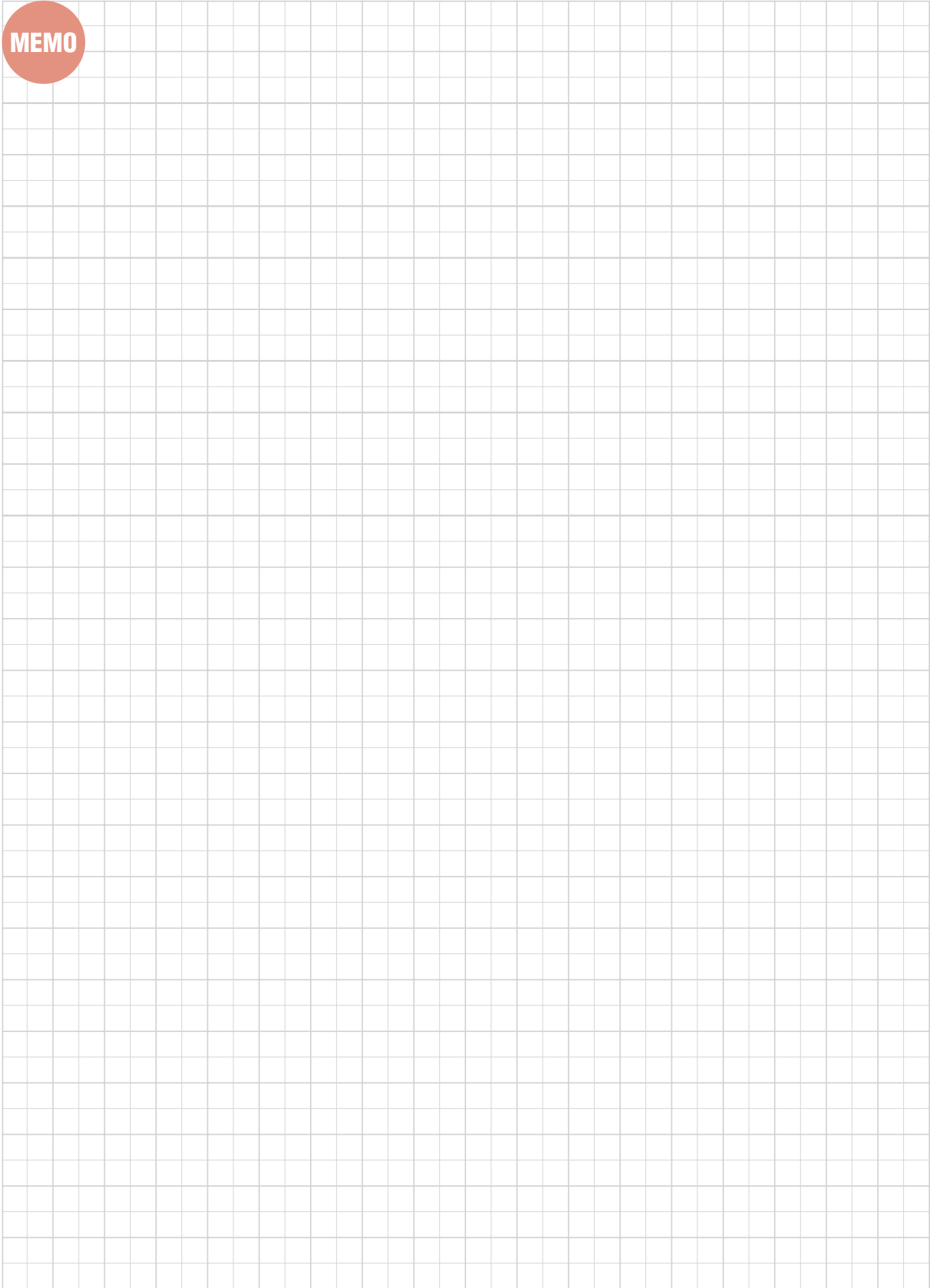

Threading Tool

60° thread angle

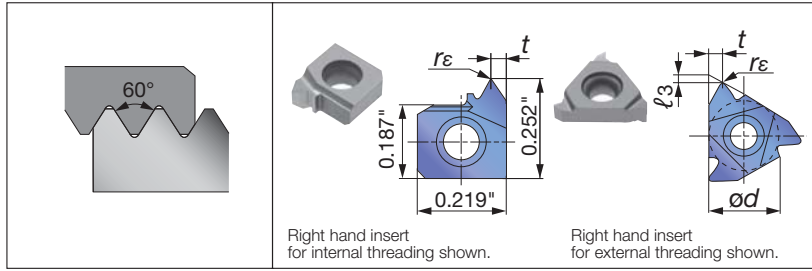

Applicable toolholders

Insert size	External	Internal
6		SNR/L000*K06SC... SNR/L000*H06...
11		SNR/L**11...
16	CER/L**16... B-SER/L**16 B-CER/L**16 BC-SER/L**16	TSNR/L**16 SNR/L**16... TCNR/L**16... CNR/L**16...
22	CER/L**22...	TSNR/L**22... SNR/L**22... TCNR/L**22... CNR/L**22...
27	CER/L**27...	CNR/L**27...

Partial-profile insert

Insert size	Pitch (in)	TPI	Hand of cut	External insert (in)							Internal insert (in)												
				Designation	Grade			ød	t	ℓ3	rε	Designation	Grade			ød	t	ℓ3	rε				
					Coated	Un-coated							Coated	Un-coated									
					AH725	T313V	TH10						AH725	T313V	TH10								
6	0.020-0.063	48~16	R																				
11	0.020-0.063	48~16	R																				
11	0.020-0.063	48~16	L																				
16	0.020-0.063	48~16	R	16ERA60	●	●	●	0.375	0.035	0.028	0.0024	16IRA60	●	●	●	0.375	0.035	0.028	0.0016				
16	0.020-0.063	48~16	L	16ELA60	●	●	●	0.375	0.035	0.028	0.0024	16ILA60	●	●	●	0.375	0.035	0.028	0.0016				
16	0.020-0.125	48~8	R	16ERAG60	●	●		0.375	0.063	0.047	0.0024	16IRAG60	●	●		0.375	0.063	0.047	0.0016				
16	0.071-0.125	14~8	R	16ERG60	●	●	●	0.375	0.063	0.047	0.0087	16IRG60	●	●	●	0.375	0.063	0.047	0.0047				
16	0.071-0.125	14~8	L	16ELG60	●	●		0.375	0.020	0.047	0.0087	16ILG60	●	●	●	0.375	0.063	0.047	0.0047				
22	0.142-0.200	7~5	R	22ERN60	●	●	●	0.500	0.020	0.047	0.0173	22IRN60	●	●	●	0.500	0.098	0.067	0.0098				
22	0.142-0.200	7~5	L	22ELN60	●	●		0.500	0.020	0.047	0.0173	22ILN60	●	●		0.500	0.098	0.067	0.0098				
27	0.167-0.250	6~4	R	27ERZ60	●	●		0.625	0.035	0.028	0.0197	27IRZ60	●	●		0.625	0.125	0.087	0.0110				

Partial-profile insert with chipbreaker

Insert size	Pitch (in)	TPI	Hand of cut	External insert (in)							Internal insert (in)												
				Designation	Grade		ød	t	ℓ3	rε	Designation	Grade		ød	t	ℓ3	rε						
					Coated	Cermet						Coated	Cermet										
					AH725	NS9530						AH725	NS9530										
11	0.020-0.063	48~16	R																				
11	0.020-0.063	48~16	R																				
16	0.020-0.063	48~16	R	16ERA60-B	●*			0.375	0.035	0.031	0.0020	16IRA60-B	●*			0.375	0.035	0.031	0.0020				
16	0.020-0.063	48~16	R	16ERA60-M		●		0.375	0.035	0.028	0.0024	16IRA60-M		●		0.375	0.063	0.043	0.0016				
16	0.020-0.125	48~8	R	16ERAG60-B	●*			0.375	0.067	0.047	0.0024	16IRAG60-B	●*			0.375	0.067	0.047	0.0020				
16	0.020-0.125	48~8	R	16ERAG60-M	●	●		0.375	0.063	0.043	0.0024	16IRAG60-M	●	●		0.375	0.063	0.047	0.0016				
16	0.071-0.125	14~8	R	16ERG60-B	●*			0.375	0.067	0.047	0.0067	16IRG60-B	●*			0.375	0.067	0.047	0.0039				
16	0.071-0.125	14~8	R	16ERG60-M		●		0.375	0.063	0.047	0.0087	16IRG60-M		●		0.375	0.063	0.047	0.0055				
22	0.142-0.200	7~5	R	22ERN60-B	●			0.500	0.098	0.067	0.0126	22IRN60-B	●			0.500	0.098	0.067	0.0075				

Note: ●* Please be aware of the different dimensions regarding "t" & "ℓ3".
Required to modify the position of the cutting edge.
Colored product needs to change the shim.

Please check the items used and replace shims if necessary (see page B431).

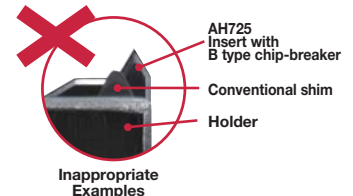

● : Line up / Packing Quantity = 5 pcs.

55° thread angle

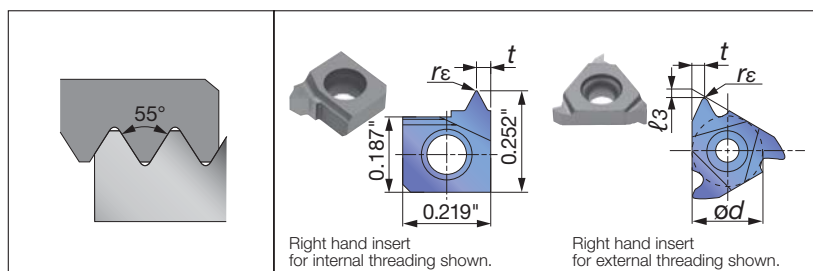

Applicable toolholders

Insert size	External	Internal
6		SNR/L000*K06SC... SNR/L000*H06...
11		SNR/L**11...
16	CER/L**16... B-SER/L**16 B-CER/L**16 BC-SER/L**16	TSNR/L**16 SNR/L**16... TCNR/L**16... CNR/L**16...
22	CER/L**22...	TSNR/L**22... SNR/L**22... TCNR/L**22... CNR/L**22...

Partial-profile insert

Insert size	Pitch (in)	TPI	Hand of cut	External insert (in)								Internal insert (in)															
				Designation	Grade			ød	t	l3	rE	Designation	Grade			ød	t	l3	rE								
					Coated	Un-coated	TH10						Coated	Un-coated	TH10												
6	0.020~0.063	48~16	R																6IRA55	●	●	-	0.035	-	0.0028		
11	0.020~0.063	48~16	R																	11IRA55	●	●	●	0.250	0.035	0.028	0.0028
16	0.020~0.063	48~16	R	16ERA55	●	●	●	0.375	0.035	0.028	0.0028	16IRA55	●	●	●	0.375	0.035	0.028	0.0028								
16	0.020~0.125	48~8	R	16ERAG55	●			0.375	0.067	0.047	0.0028	16IRAG55	●			0.375	0.067	0.047	0.0028								
16	0.071~0.125	14~8	R	16ERG55	●	●	●	0.375	0.063	0.047	0.0110	16IRG55	●	●	●	0.375	0.067	0.047	0.0098								
22	0.142~0.200	7~5	R	22ERN55	●	●	●	0.500	0.098	0.067	0.0197	22IRN55	●	●	●	0.500	0.098	0.067	0.0197								

Partial-profile insert with chipbreaker

Insert size	Pitch (in)	TPI	Hand of cut	External insert (in)								Internal insert (in)							
				Designation	Grade		ød	t	l3	rE	Designation	Grade		ød	t	l3	rE		
					Coated	AH725						Coated	AH725						
16	0.020~0.063	48~16	R	16ERAG55-B	●*			0.375	0.067	0.047	0.0028	16IRAG55-B	●*			0.375	0.067	0.047	0.0020
16	0.071~0.125	14~8	R	16ERG55-B	●*			0.375	0.067	0.047	0.0091	16IRG55-B	●*			0.375	0.067	0.047	0.0079

Note: ●* Please be aware of the different dimensions regarding "t" & "l3".

Required to modify the position of the cutting edge.

Colored product needs to change the shim.

Please check the items used and replace shims if necessary (see page B431).

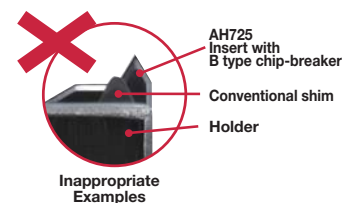

Threading Tool

● : Line up / Packing Quantity = 5 pcs.

ISO metric

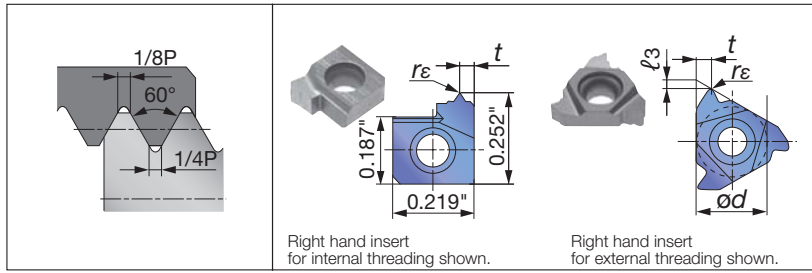

Applicable toolholders

Insert size	External	Internal
6		SNR/L000*K06SC... SNR/L000*H06...
11		SNR/L**11...
16	CER/L**16... B-SER/L**16 B-CER/L**16 BC-SER/L**16	TSNR/L**16 SNR/L**16... TCNR/L**16... CNR/L**16...
22	CER/L**22...	TSNR/L**22 SNR/L**22... TCNR/L**22... CNR/L**22...
27	CER/L**27...	CNR/L**27...

Full-profile insert

Insert size	Pitch (mm)	Hand of cut	External insert (in)							Internal insert (in)										
			Designation	Grade			ød	t	l ₃	r _ε	Designation	Grade			ød	t	l ₃	r _ε		
				Coated		Un-coated						Coated		Un-coated						
				AH725	T313V	TH10						AH725	T313V	TH10						
6	0.75	R																		
6	1	R																		
6	1.25	R																		
6	1.5	R																		
6	1.75	R																		
6	2	R																		
11	0.5	R																		
11	0.75	R																		
11	1	R																		
11	1	L																		
11	1.25	R																		
11	1.25	L																		
11	1.5	R																		
11	1.5	L																		
11	1.75	R																		
11	1.75	L																		
11	2	R																		
11	2	L																		
16	0.5	R	16ER05ISO	●	●	●	0.375	0.020	0.047	0.0024	16IR05ISO	●	●	●	0.375	0.020	0.047	0.0016		
16	0.75	R	16ER075ISO	●	●	●	0.375	0.020	0.047	0.0035	16IR075ISO	●	●	●	0.375	0.020	0.047	0.0020		
16	1	R	16ER10ISO	●	●	●	0.375	0.035	0.028	0.0051	16IR10ISO	●	●	●	0.375	0.035	0.028	0.0028		
16	1	L	16EL10ISO				0.375	0.035	0.028	0.0051	16IL10ISO	●			0.375	0.035	0.028	0.0028		
16	1.25	R	16ER125ISO	●	●	●	0.375	0.035	0.028	0.0063	16IR125ISO	●	●	●	0.375	0.035	0.028	0.0035		
16	1.25	L	16EL125ISO				0.375	0.035	0.028	0.0063	16IL125ISO	●			0.375	0.035	0.028	0.0035		
16	1.5	R	16ER15ISO	●	●	●	0.375	0.035	0.028	0.0075	16IR15ISO	●	●	●	0.375	0.035	0.028	0.0043		
16	1.5	L	16EL15ISO	●	●		0.375	0.035	0.028	0.0075	16IL15ISO	●			0.375	0.035	0.028	0.0043		
16	1.75	R	16ER175ISO	●	●	●	0.375	0.063	0.047	0.0087	16IR175ISO	●	●	●	0.375	0.063	0.047	0.0047		
16	2	R	16ER20ISO	●	●	●	0.375	0.063	0.047	0.0098	16IR20ISO	●	●	●	0.375	0.063	0.047	0.0055		
16	2	L	16EL20ISO	●			0.375	0.063	0.047	0.0098	16IL20ISO	●			9.525	0.063	0.047	0.0055		
16	2.5	R	16ER25ISO	●	●	●	0.375	0.063	0.047	0.0122	16IR25ISO	●	●	●	0.375	0.063	0.047	0.0071		
16	3	R	16ER30ISO	●	●	●	0.375	0.063	0.047	0.0150	16IR30ISO	●	●	●	0.375	0.063	0.047	0.0083		
16	3	L	16EL30ISO				0.375	0.063	0.047	0.0150	16IL30ISO	●			0.375	0.063	0.047	0.0083		

● : Line up / Packing Quantity = 5 pcs.

Insert size	Pitch (mm)	Hand of cut	External insert (in)							Internal insert (in)								
			Designation	Grade			ød	t	ℓ ₃	r _ε	Designation	Grade			ød	t	ℓ ₃	r _ε
				Coated		Un-coated						Coated		Un-coated				
				AH725	T313V	TH10						AH725	T313V	TH10				
22	3.5	R	22ER35ISO	●	●	0.500	0.098	0.067	0.0173	22IR35ISO	●	●	0.500	0.098	0.067	0.0098		
22	4	R	22ER40ISO	●	●	0.500	0.098	0.067	0.0197	22IR40ISO	●	●	0.500	0.098	0.067	0.0110		
22	4.5	R	22ER45ISO	●		0.500	0.098	0.067	0.0220	22IR45ISO	●		0.500	0.098	0.067	0.0126		
22	5	R	22ER50ISO	●	●	0.500	0.098	0.067	0.0248	22IR50ISO	●	●	0.500	0.098	0.067	0.0138		
27	6	R	27ER60ISO	●	●	0.625	0.126	0.087	0.0295	27IR60ISO	●	●	0.625	0.126	0.087	0.0165		

Full-profile insert with chipbreaker

Insert size	Pitch (mm)	Hand of cut	External insert (in)							Internal insert (in)						
			Designation	Grade		ød	t	ℓ ₃	r _ε	Designation	Grade		ød	t	ℓ ₃	r _ε
				Coated	Cermet						Coated	Cermet				
				AH725	NS9530						AH725	NS9530				
11	0.5	R							11IR05ISO-B	●		0.250	0.020	0.047	0.0016	
11	0.5	R							11IR05ISO-M		●	0.250	0.020	0.047	0.0016	
11	0.75	R							11IR075ISO-B	●		0.250	0.020	0.047	0.0020	
11	0.75	R							11IR075ISO-M		●	0.250	0.020	0.047	0.0020	
11	1	R							11IR10ISO-B	●		0.250	0.035	0.028	0.0031	
11	1	R							11IR10ISO-M		●	0.250	0.035	0.028	0.0031	
11	1.25	R							11IR125ISO-B	●		0.250	0.035	0.028	0.0039	
11	1.25	R							11IR125ISO-M		●	0.250	0.035	0.028	0.0039	
11	1.5	R							11IR15ISO-B	●		0.250	0.035	0.028	0.0047	
11	1.5	R							11IR15ISO-M		●	0.250	0.035	0.028	0.0047	
11	1.75	R							11IR175ISO-B	●		0.250	0.035	0.028	0.0047	
11	1.75	R							11IR175ISO-M		●	0.250	0.035	0.028	0.0047	
11	2	R							11IR20ISO-B	●		0.250	0.035	0.028	0.0055	
11	2	R							11IR20ISO-M		●	0.250	0.035	0.028	0.0055	
16	0.5	R	16ER05ISO-M		●	0.375	0.020	0.047	0.0024							
16	0.75	R	16ER075ISO-B	●*		0.375	0.024	0.024	0.0031							
16	0.75	R	16ER075ISO-M		●	0.375	0.020	0.047	0.0035							
16	1	R	16ER10ISO-B	●*		0.375	0.7	0.028	0.0043	16IR10ISO-B	●*		0.375	0.028	0.024	0.0020
16	1	R	16ER10ISO-M	●	●	0.375	0.035	0.028	0.0051	16IR10ISO-M		●	0.375	0.035	0.028	0.0031
16	1.25	R	16ER125ISO-B	●*		0.375	0.035	0.031	0.0055	16IR125ISO-B	●*		0.375	0.035	0.031	0.0028
16	1.25	R	16ER125ISO-M		●	0.375	0.035	0.028	0.0063	16IR125ISO-M		●	0.375	0.035	0.028	0.0039
16	1.5	R	16ER15ISO-B	●*		0.375	0.039	0.031	0.0075	16IR15ISO-B	●*		0.375	0.039	0.031	0.0031
16	1.5	R	16ER15ISO-M	●	●	0.375	0.035	0.028	0.0075	16IR15ISO-M	●	●	0.375	0.035	0.028	0.0047
16	1.75	R	16ER175ISO-B	●*		0.375	0.047	0.035	0.0079	16IR175ISO-B	●*		0.375	0.047	0.035	0.0039
16	1.75	R	16ER175ISO-M		●	0.375	0.063	0.047	0.0087	16IR175ISO-M		●	0.375	0.063	0.047	0.0055
16	2	R	16ER20ISO-B	●*		0.375	0.051	0.039	0.0094	16IR20ISO-B	●*		0.375	0.051	0.039	0.0043
16	2	R	16ER20ISO-M	●	●	0.375	0.063	0.047	0.0098	16IR20ISO-M		●	0.375	0.063	0.047	0.0055
16	2.5	R	16ER25ISO-B	●*		0.375	0.059	0.043	0.0118	16IR25ISO-B	●*		0.375	0.059	0.043	0.0055
16	2.5	R	16ER25ISO-M		●	0.375	0.063	0.047	0.0122	16IR25ISO-M		●	0.375	0.063	0.047	0.0071
16	3	R	16ER30ISO-B	●*		0.375	0.063	0.047	0.0150	16IR30ISO-B	●*		0.375	0.059	0.043	0.0071
16	3	R	16ER30ISO-M		●	0.375	0.063	0.047	0.0150	16IR30ISO-M		●	0.375	0.063	0.047	0.0083
22	3.5	R	22ER35ISO-B	●		0.500	0.091	0.063	0.0189							
22	4	R	22ER40ISO-B	●		0.500	0.091	0.063	0.0205							

Note: ● Please be aware of the different dimensions regarding "t" & "ℓ₃".
 Required to modify the position of the cutting edge.
 Colored product needs to change the shim.

Please check the items used and replace shims if necessary(see page B431).

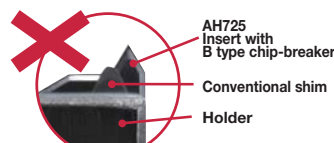

Inappropriate Examples

● : Line up / Packing Quantity = 5 pcs.

Unified

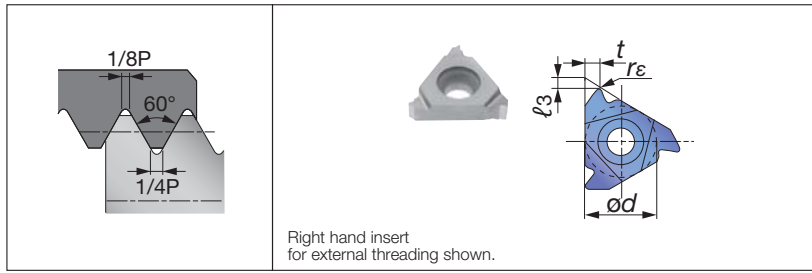

Applicable toolholders

Insert size	External	Internal
	11	
16	CER/L**16...	TSNR/L**16
	B-SER/L**16	SNR/L**16...
	B-CER/L**16	TCNR/L**16...
	BC-SER/L**16	CNR/L**16...
22	CER/L**22...	TSNR/L**22
		SNR/L**22...
		TCNR/L**22...
		CNR/L**22...

Full-profile insert

Insert size	Pitch (Reference) (in)	TPI	Hand of cut	External insert (in)							Internal insert (in)												
				Designation	Grade		od	t	l3	rE	Designation	Grade		od	t	l3	rE						
					Coated							Coated											
					AH725	T313V						AH725	T313V										
11	(0.031)	32	R													11IR32UN	●		0.250	0.020	0.047	0.0024	
11	(0.036)	28	R														11IR28UN	●		0.250	0.020	0.047	0.0024
11	(0.042)	24	R														11IR24UN	●		0.250	0.035	0.028	0.0028
11	(0.050)	20	R														11IR20UN	●		0.250	0.035	0.028	0.0035
11	(0.056)	18	R														11IR18UN	●		0.250	0.035	0.028	0.0039
11	(0.063)	16	R														11IR16UN	●		0.250	0.035	0.028	0.0043
11	(0.071)	14	R														11IR14UN	●		0.250	0.035	0.028	0.0051
16	(0.031)	32	R	16ER32UN	●		0.375	0.020	0.047	0.0039	16IR32UN	●		0.375	0.020	0.047	0.0024						
16	(0.036)	28	R	16ER28UN	●		0.375	0.020	0.047	0.0043	16IR28UN	●		0.375	0.020	0.047	0.0024						
16	(0.042)	24	R	16ER24UN	●		0.375	0.035	0.028	0.0051	16IR24UN	●		0.375	0.035	0.028	0.0028						
16	(0.050)	20	R	16ER20UN	●		0.375	0.035	0.028	0.0063	16IR20UN	●		0.375	0.035	0.028	0.0035						
16	(0.056)	18	R	16ER18UN	●		0.375	0.035	0.028	0.0071	16IR18UN	●		0.375	0.035	0.028	0.0039						
16	(0.063)	16	R	16ER16UN	●	●	0.375	0.035	0.028	0.0079	16IR16UN	●	●	0.375	0.035	0.028	0.0043						
16	(0.071)	14	R	16ER14UN	●	●	0.375	0.063	0.047	0.0091	16IR14UN	●	●	0.375	0.063	0.047	0.0051						
16	(0.077)	13	R	16ER13UN	●		0.375	0.063	0.047	0.0094	16IR13UN	●		0.375	0.063	0.047	0.0055						
16	(0.083)	12	R	16ER12UN	●	●	0.375	0.063	0.047	0.0106	16IR12UN	●	●	0.375	0.063	0.047	0.0059						
16	(0.091)	11	R	16ER11UN	●		0.375	0.063	0.047	0.0114	16IR11UN	●		0.375	0.063	0.047	0.0063						
16	(0.100)	10	R	16ER10UN	●		0.375	0.063	0.047	0.0126	16IR10UN	●		0.375	0.063	0.047	0.0071						
16	(0.111)	9	R	16ER9UN	●		0.375	0.063	0.047	0.0138	16IR9UN	●		0.375	0.063	0.047	0.0079						
16	(0.125)	8	R	16ER8UN	●	●	0.375	0.063	0.047	0.0157	16IR8UN	●	●	0.375	0.063	0.047	0.0087						
22	(0.143)	7	R	22ER7UN	●		0.500	0.098	0.067	0.0177	22IR7UN	●		0.500	0.098	0.067	0.0098						
22	(0.167)	6	R	22ER6UN	●		0.500	0.098	0.067	0.0209	22IR6UN	●		0.500	0.098	0.067	0.0118						
22	(0.200)	5	R	22ER5UN	●		0.500	0.098	0.067	0.0252	22IR5UN	●		0.500	0.098	0.067	0.0142						

Threading Tool

● : Line up / Packing Quantity = 5 pcs.

Full-profile insert with chipbreaker

Insert size	Pitch (Reference) (in)	TPI	Hand of cut	External insert (in)					Internal insert (in)								
				Designation	Grade		ϕd	t	l_3	r_ϵ	Designation	Grade		ϕd	t	l_3	r_ϵ
					Coated	Cermet						Coated	Cermet				
					AH725	NS9530						AH725	NS9530				
16 (0.042)	24	R	16ER24UN-B	●*		0.375	0.031	0.028	0.0043								
16 (0.042)	24	R	16ER24UN-M		●	0.375	0.035	0.028	0.0051								
16 (0.050)	20	R	16ER20UN-B	●*		0.375	0.035	0.031	0.0055	16IR20UN-B	●*		0.375	0.035	0.031	0.0024	
16 (0.050)	20	R	16ER20UN-M		●	0.375	0.035	0.028	0.0063	16IR20UN-M		●	0.375	0.035	0.028	0.0035	
16 (0.056)	18	R	16ER18UN-B	●*		0.375	0.039	0.031	0.0059	16IR18UN-B	●*		0.375	0.039	0.031	0.0031	
16 (0.056)	18	R	16ER18UN-M		●	0.375	0.035	0.028	0.0071	16IR18UN-M		●	0.375	0.035	0.028	0.0039	
16 (0.063)	16	R	16ER16UN-B	●*		0.375	0.043	0.035	0.19	16IR16UN-B	●*		0.375	0.043	0.035	0.0035	
16 (0.063)	16	R	16ER16UN-M		●	0.375	0.035	0.028	0.0079	16IR16UN-M		●	0.375	0.035	0.028	0.0043	
16 (0.071)	14	R	16ER14UN-B	●*		0.375	0.047	0.039	0.0087	16IR14UN-B	●*		0.375	0.047	0.035	0.0043	
16 (0.071)	14	R	16ER14UN-M		●	0.375	0.063	0.047	0.0091	16IR14UN-M		●	0.375	0.063	0.047	0.0043	
16 (0.077)	13	R	16ER13UN-B	●*		0.375	0.051	0.039	0.0094								
16 (0.083)	12	R	16ER12UN-B	●*		0.375	0.055	0.043	0.0098	16IR12UN-B	●*		0.375	0.055	0.043	0.0047	
16 (0.083)	12	R	16ER12UN-M		●	0.375	0.063	0.047	0.0106	16IR12UN-M		●	0.375	0.063	0.047	0.0059	
16 (0.125)	8	R	16ER8UN-B	●*		0.375	0.063	0.047	0.0161	16IR8UN-B	●*		0.375	0.059	0.043	0.0075	
16 (0.125)	8	R	16ER8UN-M		●	0.375	0.063	0.047	0.0157	16IR8UN-M		●	0.375	0.063	0.047	0.0087	

Note: ●* Please be aware of the different dimensions regarding "t" & "l₃".
 Required to modify the position of the cutting edge.
 Colored product needs to change the shim.

Please check the items used and replace shims if necessary (see page B431).

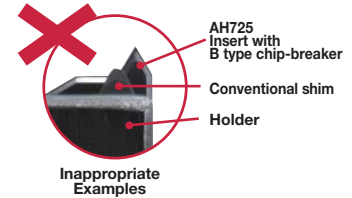

Whitworth

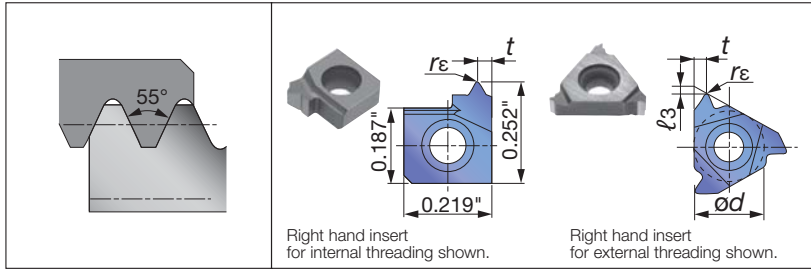

Right hand insert for internal threading shown.

Right hand insert for external threading shown.

Applicable toolholders

Insert size	External	Internal
6		SNR/L000*K06SC... SNR/L000*H06...
11		SNR/L**11...
16	CER/L**16... B-SER/L**16 B-CER/L**16 BC-SER/L**16	TSNR/L**16 SNR/L**16... TCNR/L**16... CNR/L**16...
22	CER/L**22...	TSNR/L**22... SNR/L**22... TCNR/L**22... CNR/L**22...

Full-profile insert

Insert size	Pitch (Reference) (in)	TPI	Hand of cut	External insert (in)							Internal insert (in)														
				Designation	Grade			ød	t	ℓ₃	r_ε	Designation	Grade			ød	t	ℓ₃	r_ε						
					Coated	Un-coated							Coated	Un-coated											
					AH725 T313V	TH10							AH725 T313V	TH10											
6	(0.053)	19	R										6IR19W								-	0.035	-	0.0067	
11	(0.053)	19	R											11IR19W								0.250	0.035	0.028	0.0067
11	(0.071)	14	R											11IR14W								0.250	0.035	0.028	0.23
16	(0.036)	28	R	16ER28W					0.375	0.035	0.028	0.0043		16IR28W								0.375	0.035	0.028	0.0043
16	(0.038)	26	R	16ER26W					0.375	0.035	0.028	0.0047		16IR26W								0.375	0.035	0.028	0.0047
16	(0.050)	20	R	16ER20W					0.375	0.035	0.028	0.0063		16IR20W								0.375	0.035	0.028	0.0063
16	(0.053)	19	R	16ER19W					0.375	0.035	0.028	0.0067		16IR19W								0.375	0.035	0.028	0.0067
16	(0.056)	18	R	16ER18W					0.375	0.035	0.028	0.0071		16IR18W								0.375	0.035	0.028	0.0071
16	(0.063)	16	R	16ER16W					0.375	0.035	0.028	0.0079		16IR16W								0.375	0.035	0.028	0.0079
16	(0.071)	14	R	16ER14W					0.375	0.063	0.047	0.0091		16IR14W								0.375	0.063	0.047	0.0091
16	(0.071)	14	L	16EL14W					0.375	0.063	0.047	0.0091													
16	(0.083)	12	R	16ER12W					0.375	0.063	0.047	0.0106		16IR12W								0.375	0.063	0.047	0.0106
16	(0.091)	11	R	16ER11W					0.375	0.063	0.047	0.0114		16IR11W								0.375	0.063	0.047	0.0114
16	(0.100)	10	R	16ER10W					0.375	0.063	0.047	0.0126		16IR10W								0.375	0.063	0.047	0.0126
16	(0.111)	9	R	16ER9W					0.375	0.063	0.047	0.0138		16IR9W								0.375	0.063	0.047	0.0138
16	(0.125)	8	R	16ER8W					0.375	0.063	0.047	0.0157		16IR8W								0.375	0.063	0.047	0.0157
22	(0.143)	7	R	22ER7W					0.500	0.098	0.067	0.0177		22IR7W								0.500	0.098	0.067	0.0177
22	(0.167)	6	R	22ER6W					0.500	0.098	0.067	0.0209		22IR6W								0.500	0.098	0.067	0.0209
22	(0.200)	5	R	22ER5W					0.500	0.098	0.067	0.0252		22IR5W								0.500	0.098	0.067	0.0252

Full-profile insert with chipbreaker

Insert size	Pitch (Reference) (in)	TPI	Hand of cut	External insert (in)							Internal insert (in)														
				Designation	Grade		ød	t	ℓ₃	r_ε	Designation	Grade		ød	t	ℓ₃	r_ε								
					Coated	Cermet						Coated	Cermet												
					AH725	NS9530						AH725	NS9530												
16	(0.053)	19	R	16ER19W-B					0.375	0.039	0.031	0.0063													
16	(0.053)	19	R	16ER19W-M					0.375	0.035	0.028	0.0067		16IR19W-M								0.375	0.035	0.028	0.0067
16	(0.063)	16	R	16ER16W-B					0.375	0.043	0.035	0.0079		16IR16W-B								0.375	0.043	0.035	0.0071
16	(0.071)	14	R	16ER14W-B					0.375	0.047	0.039	0.0094		16IR14W-B								0.375	0.047	0.039	0.0083
16	(0.071)	14	R	16ER14W-M					0.375	0.063	0.047	0.0091		16IR14W-M								0.375	0.063	0.047	0.0091
16	(0.091)	11	R	16ER11W-B					0.375	0.059	0.043	0.0106		16IR11W-B								0.375	0.059	0.043	0.0106
16	(0.091)	11	R	16ER11W-M					0.375	0.063	0.047	0.0114		16IR11W-M								0.375	0.063	0.047	0.0114

Note: ●* Please be aware of the different dimensions regarding "t" & "ℓ₃".

Required to modify the position of the cutting edge.

Colored product needs to change the shim.

Please check the items used and replace shims if necessary (see page B431).

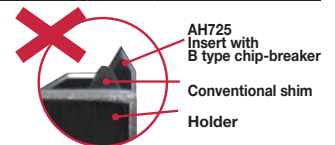

Inappropriate Examples

● : Line up / Packing Quantity = 5 pcs.

Taper pipe

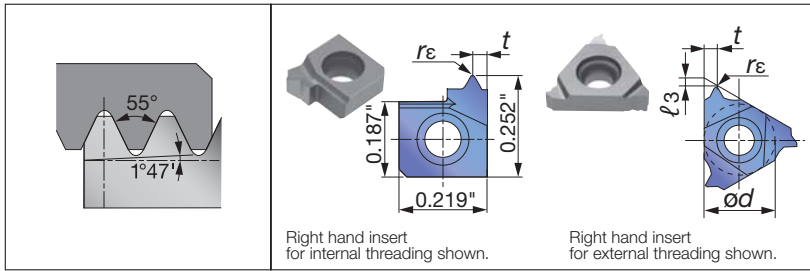

Applicable toolholders

Insert size	External	Internal
6		SNR/L000*K06SC... SNR/L000*H06...
11		SNR/L**11...
16	CER/L**16... B-SER/L**16 B-CER/L**16 BC-SER/L**16	TSNR/L**16 SNR/L**16... TCNR/L**16... CNR/L**16...

Full-profile insert

Insert size	Pitch (Reference) (in)	TPI	Hand of cut	External insert (in)						Internal insert (in)																
				Designation	Grade			ød	t	l ₃	r _ε	Designation	Grade			ød	t	l ₃	r _ε							
					Coated	Un-coated							Coated	Un-coated												
					AH725	T313V	TH10						AH725	T313V	TH10											
6	(0.053)	19	R															6IR19PT	●	●	-	0.035	-	0.0055		
11	(0.053)	19	R																11IR19PT	●	●	●	0.250	0.035	0.028	0.0055
11	(0.071)	14	R																11IR14PT	●	●	●	0.250	0.035	0.028	0.0063
16	(0.036)	28	R	16ER28PT	●	●		0.375	0.035	0.028	0.0035															
16	(0.053)	19	R	16ER19PT	●	●		0.375	0.035	0.028	0.0055	16IR19PT	●			0.375	0.035	0.028	0.0055							
16	(0.071)	14	R	16ER14PT	●	●		0.375	0.063	0.047	0.0063	16IR14PT	●	●	●	0.375	0.063	0.047	0.0063							
16	(0.091)	11	R	16ER11PT	●	●		0.375	0.063	0.047	0.0102	16IR11PT	●	●	●	0.375	0.063	0.047	0.0102							

Full-profile insert with chipbreaker

Insert size	Pitch (Reference) (in)	TPI	Hand of cut	External insert (in)						Internal insert (in)									
				Designation	Grade			ød	t	l ₃	r _ε	Designation	Grade			ød	t	l ₃	r _ε
					Coated	Cermet							Coated	Cermet					
					AH725	NS9530	AH725						NS9530						
16	(0.053)	19	R	16ER19PT-M		●		0.375	0.035	0.028	0.0071	16IR19PT-M		●		0.375	0.035	0.028	0.0071
16	(0.071)	14	R	16ER14PT-B	●*			0.375	0.047	0.039	0.0083	16IR14PT-B	●*			0.375	0.039	0.047	0.0083
16	(0.071)	14	R	16ER14PT-M		●		0.375	0.063	0.047	0.0098	16IR14PT-M		●		0.375	0.063	0.047	0.0098
16	(0.091)	11	R	16ER11PT-B	●*			0.375	0.059	0.043	0.0110	16IR11PT-B	●*			0.375	0.059	0.043	0.0110
16	(0.091)	11	R	16ER11PT-M		●		0.375	0.063	0.047	0.0126	16IR11PT-M		●		0.375	0.063	0.047	0.0126

Note: ●* Please be aware of the different dimensions regarding "t" & "l₃".
Required to modify the position of the cutting edge.
Colored product needs to change the shim.

Please check the items used and replace shims if necessary (see page B431).

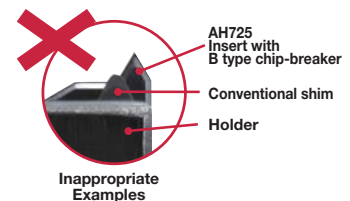

Threading Tool

● : Line up / Packing Quantity = 5 pcs.

NPTF

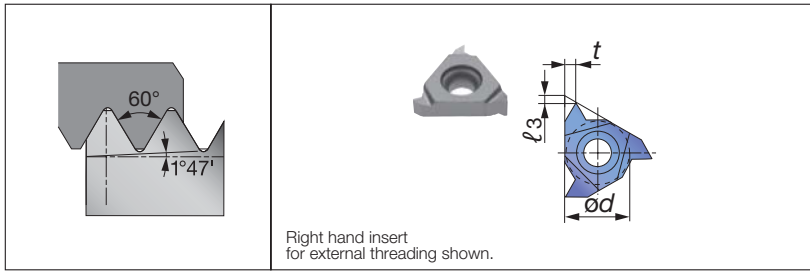

Applicable toolholders

Insert size	External	Internal
16	CER/L**16... B-SER/L**16 B-CER/L**16 BC-SER/L**16	TSNR/L**16 SNR/L**16... TCNR/L**16... CNR/L**16...

Full-profile insert

Insert size	Pitch (Reference) (in)	TPI	Hand of cut	External insert (in)					Internal insert (in)							
				Designation	Grade	ød	t	l ₃	r _ε	Designation	Grade	ød	t	l ₃	r _ε	
					Coated						Coated					
					AH725						AH725					
16 (0.037)	27	R	16ER27NPTF	●	0.375	0.020	0.047	-								
16 (0.056)	18	R	16ER18NPTF	●	0.375	0.035	0.028	-								
16 (0.071)	14	R	16ER14NPTF	●	0.375	0.063	0.047	-	16IR14NPTF	●	0.375	0.063	0.047	-		
16 (0.087)	11.5	R	16ER115NPTF	●	0.375	0.063	0.047	-	16IR115NPTF	●	0.375	0.063	0.047	-		
16 (0.125)	8	R	16ER8NPTF	●	0.375	0.063	0.047	-	16IR8NPTF	●	0.375	0.063	0.047	-		



Threading Tool

● : Line up / Packing Quantity = 5 pcs.

30° Trapezoidal (DIN103)

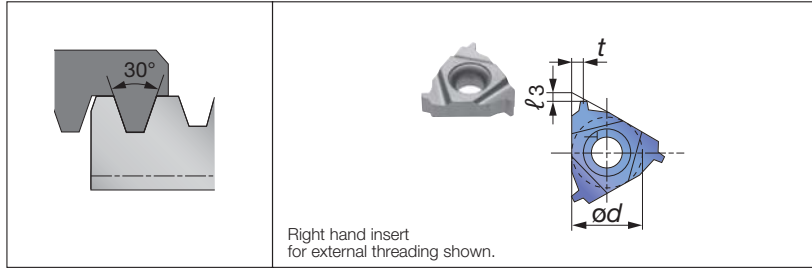

Applicable toolholders

Insert size	External	Internal
16	CER/L**16... B-SER/L**16 B-CER/L**16 BC-SER/L**16	TSNR/L**16 SNR/L**16... TCNR/L**16... CNR/L**16...
22	CER/L**22...	TSNR/L**22 SNR/L**22... TCNR/L**22... CNR/L**22...
27	CER/L**27...	

Special full-profile insert (see page B439)

Insert size	Pitch (mm)	Hand of cut	External insert (in)						Internal insert (in)					
			Designation	Grade		ød	t	l ₃	Designation	Grade		ød	t	l ₃
				Coated						Coated				
				AH725	T313V					AH725	T313V			
16	1.5	R	16ER15TR	●		0.375	0.035	0.028	16IR15TR	●		0.375	0.035	0.028
16	2	R	16ER20TR	●	●	0.375	0.063	0.051	16IR20TR	●	●	0.375	0.063	0.051
16	3	R	16ER30TR	●	●	0.375	0.063	0.051	16IR30TR	●	●	0.375	0.063	0.051
22	4	R	22ER40TR	●	●	0.500	0.098	0.079	22IR40TR	●	●	0.500	0.098	0.079
22	5	R	22ER50TR	●	●	0.500	0.098	0.079	22IR50TR	●	●	0.500	0.098	0.079
27	6	R	27ER60TR	●	●	0.625	0.126	0.098						

Threading Tool

29° Trapezoidal (ACME)

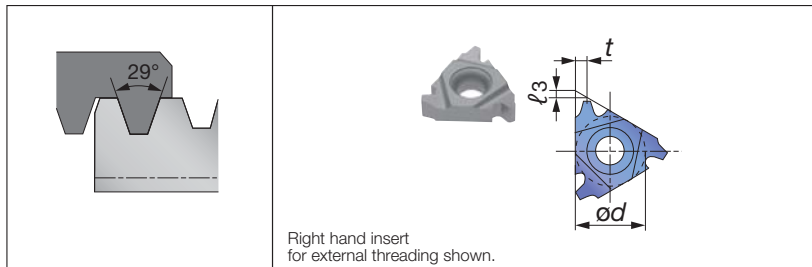

Applicable toolholders

Insert size	External	Internal
16	CER/L**16... B-SER/L**16 B-CER/L**16 BC-SER/L**16	TSNR/L**16 SNR/L**16... TCNR/L**16... CNR/L**16...
22	CER/L**22...	TSNR/L**22 SNR/L**22... TCNR/L**22... CNR/L**22...

Special full-profile insert (see page B439)

Insert size	Pitch (Reference) (in)	TPI	Hand of cut	External insert (in)						Internal insert (in)					
				Designation	Grade		ød	t	l ₃	Designation	Grade		ød	t	l ₃
					Coated						Coated				
					AH725	T313V					AH725	T313V			
16	(0.083)	12	R	16ER12ACME	●		0.375	0.063	0.051	16IR12ACME	●		0.375	0.063	0.051
16	(0.100)	10	R	16ER10ACME	●		0.375	0.063	0.051	16IR10ACME	●		0.375	0.063	0.051
16	(0.125)	8	R	16ER8ACME	●	●	0.375	0.063	0.051	16IR8ACME	●	●	0.375	0.063	0.051
16	(0.125)	8	R	16ER8TPI29(STACME)	●		0.375	0.063	0.051	16IR8TPI29(STACME)	●		0.375	0.063	0.051
22	(0.167)	6	R	22ER6ACME	●	●	0.500	0.098	0.079	22IR6ACME	●	●	0.500	0.098	0.079
22	(0.166)	6	R	22ER6TPI29(STACME) AH725	●		0.500	0.080	0.078	22IR6TPI29(STACME) AH725	●		0.500	0.080	0.078
22	(0.200)	5	R	22ER5ACME	●	●	0.500	0.098	0.079	22IR5ACME	●	●	0.500	0.098	0.079
22	(0.200)	5	R	22ER5TPI29(STACME) AH725	●		0.500	0.098	0.078	22IR5TPI29(STACME) AH725	●		0.500	0.098	0.078

Note: TPI29 inserts are semi-topping, STACME inserts are full-topping.

● : Line up / Packing Quantity = 5 pcs.

API Round

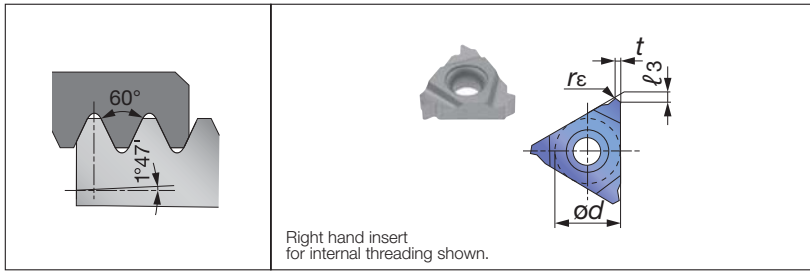

Applicable toolholders

Insert size	External	Internal
16	CER/L**16... B-SER/L**16 B-CER/L**16 BC-SER/L**16	TSNR/L**16 SNR/L**16... TCNR/L**16... CNR/L**16...

Full-profile insert

Insert size	Pitch (Reference) (in)	TPI	Hand of cut	External insert (in)					Internal insert (in)								
				Designation	Grade		ød	t	l ₃	r _ε	Designation	Grade		ød	t	l ₃	r _ε
					Coated							Coated					
					AH725	T313V						AH725	T313V				
16	(0.100)	10	R	16ER10RAPI	●		0.375	0.063	0.047	0.0142	16IR10RAPI	●	●	0.375	0.063	0.047	0.0142
16	(0.125)	8	R	16ER8RAPI	●		0.375	0.063	0.047	0.0169	16IR8RAPI	●	●	0.375	0.063	0.047	0.0169

Full-profile insert with chipbreaker

Insert size	Pitch (Reference) (in)	TPI	Hand of cut	External insert (in)					Internal insert (in)								
				Designation	Grade		ød	t	l ₃	r _ε	Designation	Grade		ød	t	l ₃	r _ε
					Coated							Coated					
					AH725							AH725					
16	(0.100)	10	R	16ER10RD-CB	●		0.375	0.047	0.059	0.0142	16IR10RD-CB	●		0.375	0.047	0.059	0.0142
16	(0.125)	8	R	16ER8RD-CB	●		0.375	0.051	0.059	0.0169	16IR8RD-CB	●		0.375	0.051	0.059	0.0169

API Buttress

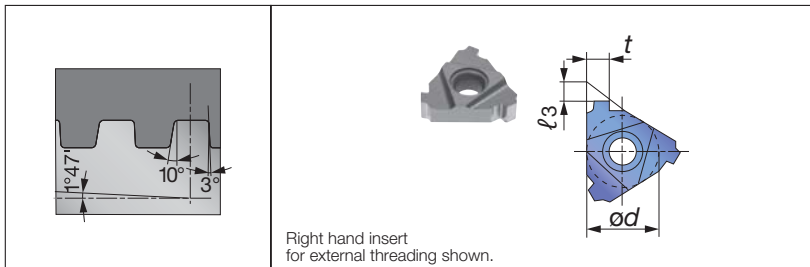

Applicable toolholders

Insert size	External	Internal
22	CER/L**22...	TSNR/L**22 SNR/L**22... TCNR/L**22... CNR/L**22...

Full-profile insert

Insert size	Pitch (Reference) (in)	TPI	Hand of cut	External insert (in)					Internal insert (in)						
				Designation	Grade		ød	t	l ₃	Designation	Grade		ød	t	l ₃
					Coated						Coated				
					AH725						AH725				
22	(0.200)	5	R	22ER5BAPI	●		0.500	0.146	0.087	22IR5BAPI	●		0.500	0.136	0.087

● : Line up / Packing Quantity = 5 pcs.

Round (DIN405)

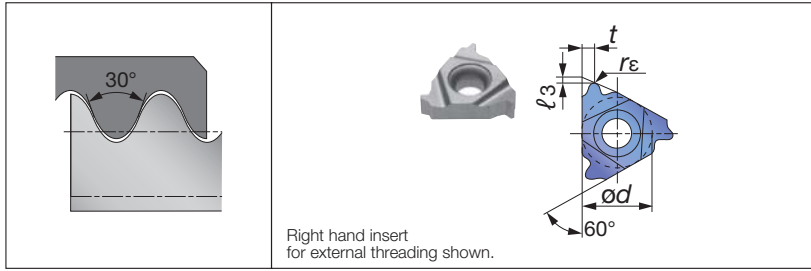

Applicable toolholders

Insert size	External	Internal
16	CER/L**16... B-SER/L**16 B-CER/L**16 BC-SER/L**16	TSNR/L**16 SNR/L**16... TCNR/L**16... CNR/L**16...

Full-profile insert

Insert size	Pitch (Reference) (in)	TPI	Hand of cut	External insert (in)					Internal insert (in)									
				Designation	Grade	ød	t	ℓ ₃	r _ε	Designation	Grade	ød	t	ℓ ₃	r _ε			
					Coated						Coated							
					AH725						AH725							
16	(0.125)	8	R	16ER8RD-B	●	0.375	0.051	0.055	-									
16	(0.125)	6	R	16ER6RD-B	●	0.375	0.067	0.059	-	16IR6RD-B	●	0.375	0.059	0.055	-			

UNJ (Aerospace)

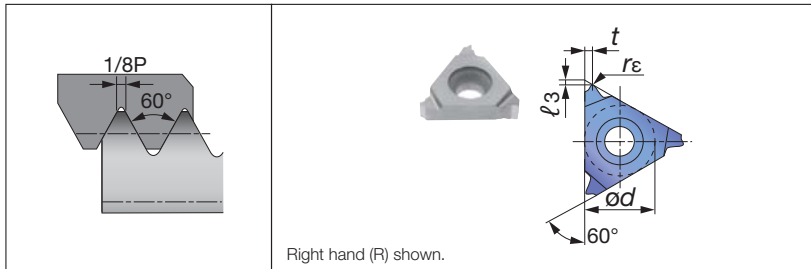

Applicable toolholders

Insert size	External
16	CER/L**16... B-SER/L**16 B-CER/L**16 BC-SER/L**16

Full-profile insert

Insert size	Pitch (Reference) (in)	TPI	Hand of cut	External insert (in)					
				Designation	Grade	ød	t	ℓ ₃	r _ε
					Coated				
					AH725				
16	(0.031)	32	R	16ER32UNJ	●	0.375	0.020	0.047	0.0051
16	(0.036)	28	R	16ER28UNJ	●	0.375	0.020	0.047	0.0059
16	(0.042)	24	R	16ER24UNJ	●	0.375	0.035	0.028	0.0071
16	(0.050)	20	R	16ER20UNJ	●	0.375	0.035	0.028	0.0083
16	(0.056)	18	R	16ER18UNJ	●	0.375	0.035	0.028	0.0094
16	(0.063)	16	R	16ER16UNJ	●	0.375	0.035	0.028	0.0102
16	(0.071)	14	R	16ER14UNJ	●	0.375	0.063	0.047	0.0118
16	(0.083)	12	R	16ER12UNJ	●	0.375	0.063	0.047	0.0138
16	(0.100)	10	R	16ER10UNJ	●	0.375	0.063	0.047	0.0165
16	(0.125)	8	R	16ER8UNJ	●	0.375	0.063	0.047	0.0209

● : Line up / Packing Quantity = 5 pcs.

IMPORTANT NOTICE - Replacement of shim sheet

Please check the items used and replace shims if necessary (see the following list).

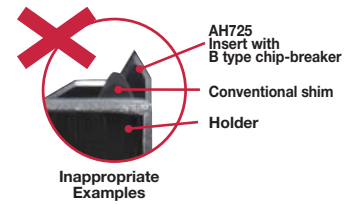

List of interchangeable Shims (Size 16 · Insert).

Holder type	Lead Angle	External designation		Internal designation	
		① Conventional	① Standard (New)	② Conventional	② Standard (New)
Dual clamping methods of screw-on and clamp-on	4°	GXE16-4DT	AE16-4DT	GXN16-4DT	AN16-4DT
	3°	GXE16-3DT	AE16-3DT	GXN16-3DT	AN16-3DT
	2°	GXE16-2DT	AE16-2DT	GXN16-2DT	AN16-2DT
	1° (Standard)	GX16-1DT	A16-1DT	GX16-1DT	A16-1DT
	0°	GXE16-0DT	AE16-0DT	GXN16-0DT	AN16-0DT
	-1°	GXE16-99DT	AE16-99DT	GXN16-99DT	AN16-99DT
	-2°	GXE16-98DT	AE16-98DT	GXN16-98DT	AN16-98DT
Clamp-on	4°	GXE16-4	AE16-4	GXN16-4	AN16-4
	3°	GXE16-3	AE16-3	GXN16-3	AN16-3
	2°	GXE16-2	AE16-2	GXN16-2	AN16-2
	1° (Standard)	GXE16-1	A16-1	GXN16-1	A16-1
	0°	GXE16-0	AE16-0	GXN16-0	AN16-0
	-1°	GXE16-99	AE16-99	GXN16-99	AN16-99
	-2°	GXE16-98	AE16-98	GXN16-98	AN16-98

Target items for the replacement of shims (Size 16 · Insert).

Thread type	External			Internal		
	Designation	Grade	Replacement	Designation	Grade	Replacement
ISO			① Conventional ↓ ① Standard (New)	16IR15ISO-B	AH725	② Conventional ↓ ② Standard (New)
				16IR175ISO-B	AH725	
				16IR20ISO-B	AH725	
55°	16ERAG55-B	AH725	① Conventional ↓ ① Standard (New)	16IRAG55-B	AH725	② Conventional ↓ ② Standard (New)
				16IRG55-B	AH725	
60°	16ERA60-B	AH725	① Conventional ↓ ① Standard (New)	16IRAG60-B	AH725	② Conventional ↓ ② Standard (New)
				16IRA60-B	AH725	
				16IRG60-B	AH725	
UN			① Conventional ↓ ① Standard (New)	16IR18UN-B	AH725	② Conventional ↓ ② Standard (New)
				16IR16UN-B	AH725	
				16IR14UN-B	AH725	
W			① Conventional ↓ ① Standard (New)	16IR16W-B	AH725	② Conventional ↓ ② Standard (New)
				16IR14W-B	AH725	
PT			① Conventional ↓ ① Standard (New)	16IR14PT-B	AH725	② Conventional ↓ ② Standard (New)
NPT	16ER8NPT-B	AH725		16IR14NPT-B	AH725	
				16IR115NPT-B	AH725	

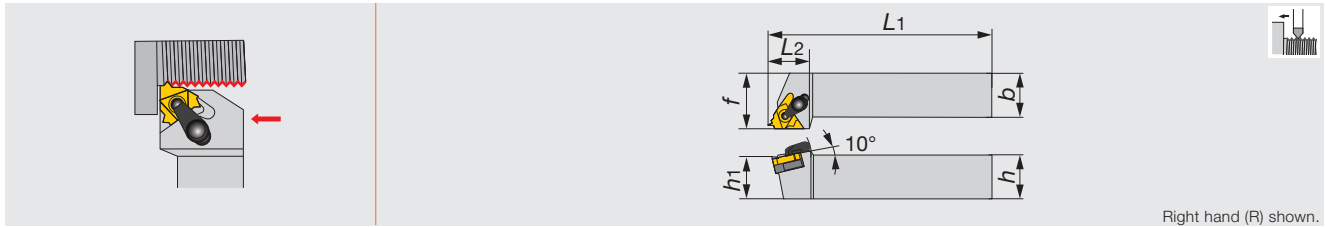









Right hand (R) shown.

Inch	h	b	L1	L2	h1	f	Insert
CER/L 123-DT	0.75	0.75	5	0.87	0.75	1	16ER/L...
CER/L 163-DT	1	1	6	1	1	1.25	16ER/L...
CER 203-DT	1.25	1.25	6	1.25	1.25	1.5	16ER/L...
CER164-DT	1	1	6	1	1	1.25	22ER/L...
CER 204-DT	1.25	1.25	6	1.25	1.25	1.50	22ER/L...

Metric	h	b	L1	L2	h1	f	Insert
CER/L1212H16DT	12	12	100	24	12	16	16ER/L...
CER/L1616H16DT	16	16	100	24	16	20	16ER/L...
CER/L2020K16DT	20	20	125	24	20	25	16ER/L...
CER/L2525M16DT	25	25	150	28	25	32	16ER/L...
CER/L2525M22DT	25	25	150	31.3	25	32	22ER/L...
CER3232P16T	32	32	170	32	32	40	16ER...
CER3232P22T	32	32	170	32	32	40	22ER...
CER2525M27T	25	25	150	34	25	32	27ER...
CER3232P27T	32	32	170	34	32	40	27ER...

Note: A clamp set for CER/L type consists of a clamp and a clamping screw. A shim set for CER/L type consists of a shim and a shim screw. Standard shims for CER/L type can be used for both left hand and right hand toolholders. Use either of the sides depending on the hand.

Threading Tool

SPARE PARTS								
Designation	Clamp set	Clamping screw	Screw	Shim	Shim set	Wrench	Wrench 1	Wrench 2
CER/L 123-DT	CSP16	CSTB-3.5ST	DTS5 - 3.5	A16 - 1DT	-	P-3.5	T-15F	-
CER/L 163-DT	CSP16	CSTB-3.5ST	DTS5 - 3.5	A16 - 1DT	-	P-3.5	T-15F	-
CER 203-DT	CSP22	CSTB-4ST	DTS6-4	GX22-1DT	-	P-3.5	T-15F	-
CER164-DT	CSP22	CSTB-4ST	DTS6-4	GX22-1DT	-	P-4	T-20F	-
CER 204-DT	CSP22	CSTB-4ST	DTS6-4	GX22-1DT	-	P-4	T-20F	-
CER/L**16DT	CSP22	CSTB-3.5ST	DTS5-3.5	A16-1DT	-	P-3.5	T-15F	-
CER/L2525M22DT	CSP22	CSTB-4ST	DTS6-4	GX22-1DT	-	P-4	T-15F	T-20F
CER3232P16T	CSP16	-	-	-	A16-1	-	T-15F	-
CER3232P22T	CSP22	-	-	-	NXE22-1	-	T-20F	-
CER**27T	CSP27	-	-	-	NXE27-1	P-4	-	-

Reference pages

CER/L: Inserts → **B418** -, Standard cutting conditions → **B416**



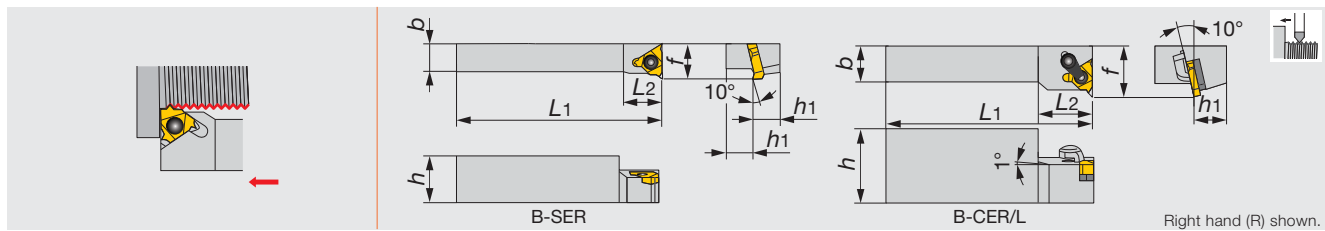

TUNGTHREAD

B-S/CER/L

External threading toolholders for small lathe



Metric	h	b	L_1	L_2	h_1	f	Insert
B-SER10H16	20	10	100	15	10	16	16ER...
B-SER12K16	24	12	125	18	12	18	16ER...
B-CER/L16M16	32	16	150	24	16	22	16ER/L...

SPARE PARTS				
Designation	Clamp set	Shim set	Clamping screw	Wrench
B-SER**16	-	-	CSTB-3.5	T-15F
B-CER/L16M16	CSP16	A16-1	-	T-15F

TUNGTHREAD

BC-SER

Multi functional external threading toolholders for small lathe

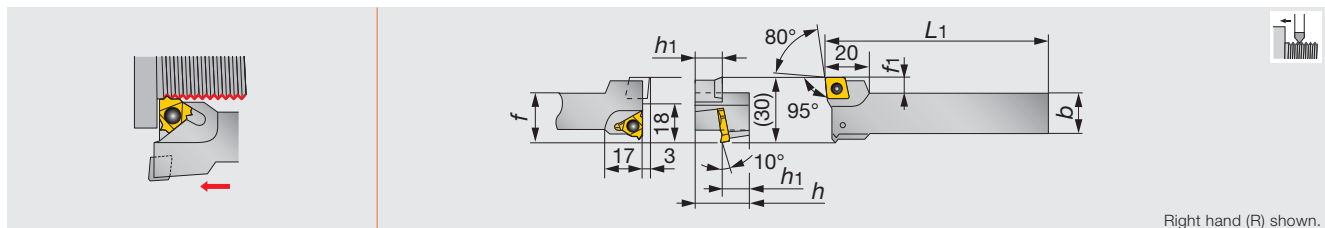

Metric	h	b	L_1	h_1	f	f_1	Insert
BC-SER12K16	24	16	125	12	23	7	16ER..., CC*T09T3...

SPARE PARTS		
Designation	Clamping screw	Wrench
BC-SER12K16	CSTB-3.5	T-15F

Threading Tool

Reference pages

B-S/CER/L: Inserts → **B418** -, Standard cutting conditions → **B416**

BC-SER: Inserts → **B106** - (CC*T09T3...), **B418** - (16ER...),
Standard cutting conditions → **B416**

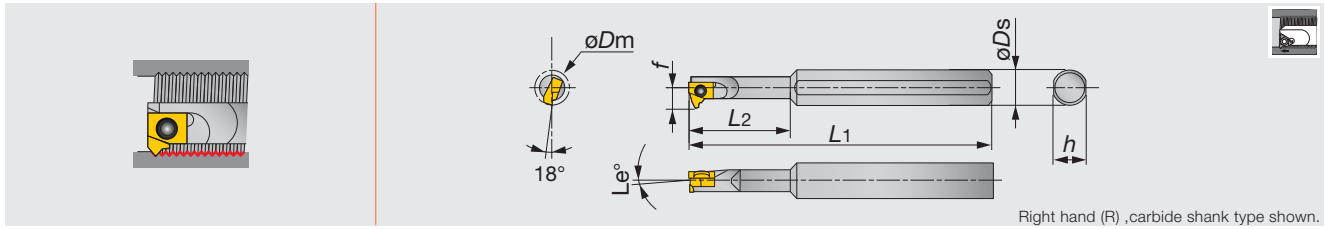

Right hand (R) ,carbide shank type shown.

Metric	Material	ϕD_m	ϕD_s	f	L_1	L_2	h	Le°	Insert
SNR0006H06-2	STEEL	8	8	4.7	100	18	7	2	6IR...
SNR0006H06-3	STEEL	8	8	4.7	100	18	7	3	6IR...
SNR0008H06-2	STEEL	10	8	5.7	100	18	7	2	6IR...
SNR0008H06-3	STEEL	10	8	5.7	100	18	7	3	6IR...
SNR0006K06SC-2	CARBIDE	8	8	4.7	125	30	7	2	6IR...
SNR0006K06SC-3	CARBIDE	8	8	4.7	125	30	7	3	6IR...
SNR0008K06SC-2	CARBIDE	10	8	5.7	125	18	7	2	6IR...
SNR0008K06SC-3	CARBIDE	10	8	5.7	125	18	7	3	6IR...

Note: When using the right hand insert (6IR** type), is used for the right hand toolholders (SNR** type).

SPARE PARTS



Designation	Clamping screw	Wrench
SNR0006H06...	CSTB-2L040	T-6F
SNR0008H06...	CSTB-2L	T-6F
SNR0006K06SC...	CSTB-2L040	T-6F
SNR0008K06SC...	CSTB-2L	T-6F

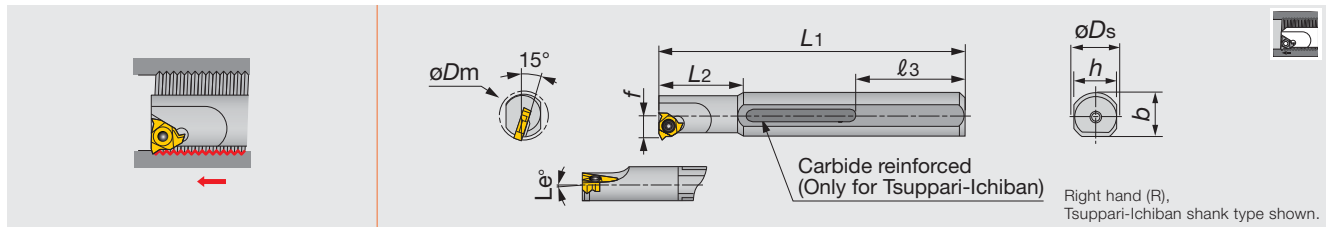

Metric	Material	ϕD_m	ϕD_s	f	L_1	L_2	L_3	h	b	Le°	Insert
TSNR0016Q16	TSUPPARI	19	16	10.6	180	40	59	15	-	1	16IR...
TSNR0020R22	TSUPPARI	24	20	13.9	200	50	49	18	-	1	22IR...
SNR/L0010K11	STEEL	12	16	6.6	125	25	-	15	15.5	1	11IR/L...
SNR0010K11-2	STEEL	12	16	6.6	125	25	-	15	15.5	2	11IR...
SNR0010K11-3	STEEL	12	16	6.6	125	25	-	15	15.5	3	11IR...
SNR/L0013L11	STEEL	15	16	8.2	140	32.5	-	15	15.5	1	11IR/L...
SNR0013L11-2	STEEL	15	16	8.2	140	32.5	-	15	15.5	2	11IR...
SNR0013L11-3	STEEL	15	16	8.2	140	32.5	-	15	15.5	3	11IR...
SNR/L0016M16	STEEL	19	16	10.6	150	40	-	15	15.5	1	16IR/L...
SNR0016M16-2	STEEL	19	16	10.6	150	40	-	15	15.5	2	16IR...
SNR0016M16-3	STEEL	19	16	10.6	150	40	-	15	15.5	3	16IR...
SNR/L0020Q22	STEEL	24	20	13.9	180	50	-	18	19	1	22IR/L...
SNR0020Q22-2	STEEL	24	20	13.9	180	50	-	18	19	2	22IR...
SNR0020Q22-3	STEEL	24	20	13.9	180	50	-	18	19	3	22IR...
SNR0010M11SC	CARBIDE	13	10	7.4	150	24	-	9	-	1	11IR...
SNR0010M11SC-2	CARBIDE	13	10	7.4	150	24	-	9	-	2	11IR...
SNR0010M11SC-3	CARBIDE	13	10	7.4	150	24	-	9	-	3	11IR...
SNR0012P11SC	CARBIDE	15	12	8.5	170	28	-	11	-	1	11IR...
SNR0012P11SC-2	CARBIDE	15	12	8.5	170	28	-	11	-	2	11IR...
SNR0012P11SC-3	CARBIDE	15	12	8.5	170	28	-	11	-	3	11IR...
SNR/L0016R16SC	CARBIDE	20	16	11.9	200	35	-	15	-	1	16IR/L...
SNR0016R16SC-2	CARBIDE	20	16	11.9	200	35	-	15	-	2	16IR...

Note: When using a right or left hand insert, the right hand insert (**IR...type) is used for the right hand toolholders (SNR...type) and left hand insert (**L...type) is used for the left hand toolholders (SNL...type).

SPARE PARTS

Designation	Clamping screw	Wrench
TSNR0016Q16	CSTB-3.5	T-15F
TSNR0020R22	CSTB-4	T-15F
SNR/L00**11...	CSTB-2.5	T-8F
SNR/L0016M16...	CSTB-3.5	T-15F
SNR/L0020Q22...	CSTB-4	T-15F
SNR00**11SC...	CSTB-2.5	T-8F
SNR/L0016R16SC...	CSTB-3.5	T-15F

Reference pages

SNR/L: Inserts → **B418** -, Standard cutting conditions → **B416**

TUNGTHREAD

SIR/L

Internal threading bars, Screw-on clamp

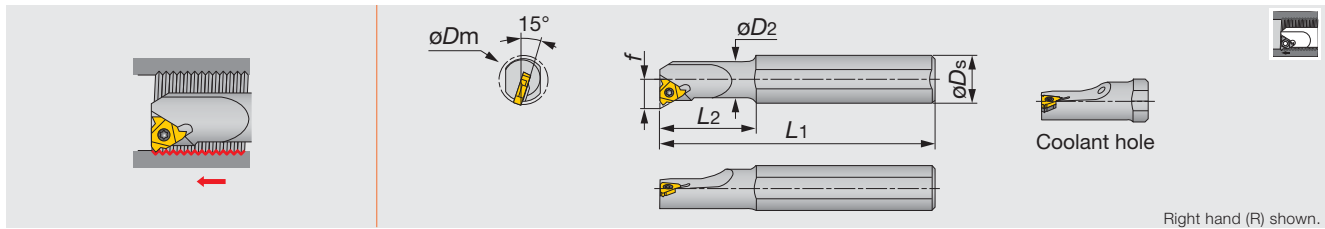

Right hand (R) shown.

Inch	Material	ϕD_m	ϕD_s	ϕD_2	f	L1	L2	Coolant	Insert
SIR 0625 P16B	STEEL	0.750	0.750	0.625	0.450	7.000	1.570	Y	16IR...
SIR 0750 P16B	STEEL	0.900	0.750	0.750	0.900	7.000	-	Y	16IR...
SIR 1000 R16B	STEEL	1.160	1.000	1.000	0.650	8.000	-	Y	16IR...
SIR 1250 S16	STEEL	1.420	1.250	1.250	0.770	10.000	-	N	16IR...

SPARE PARTS

Designation	Clamping screw	Shim	Shim screw	Wrench	Seal cap
SIR 0625 P16B	SR 5-40-L9.7-S16S	-	-	T-10/5	PL 075
SIR 0750 P16B	SR 5-40-L12.2-S16	AI16	SR 5-40-L6.8-A16	T-10/5	PL 075
SIR 1000 R16B	SR 5-40-L12.2-S16	AI16	SR 5-40-L6.8-A16	T-10/5	PL 100
SIR 1250 S16	SR 5-40-L12.2-S16	AI16	SR 5-40-L6.8-A16, SR 8-32-L5.8-A22	T-10/5	-

Threading Tool

TUNGTHREAD

CNR

Internal grooving bars, alternative clamping of screw-on or clamp-on (DT type only)

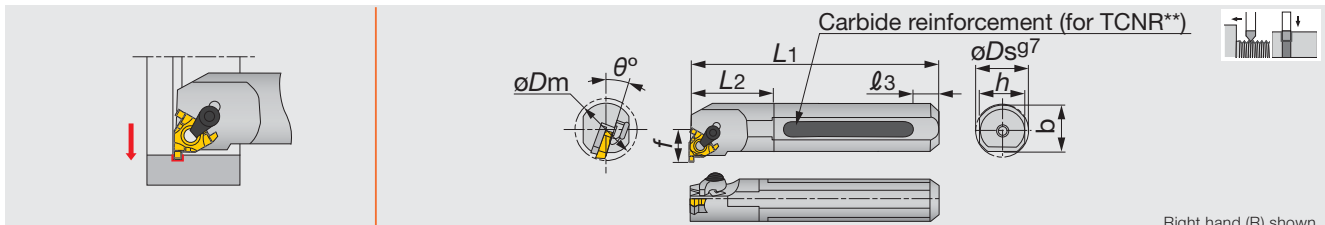

Right hand (R) shown.

Inch	Material	ϕD_m	ϕD_s	f	L1	L2	l3	h	b	θ°	Insert
S12-CNR3DT	STEEL	0.950	0.750	0.552	7.000	1.200	-	0.725	0.738	15	GTGN-16...
S16-CNR3DT	STEEL	1.150	1.000	0.652	8.000	1.500	-	0.906	0.953	15	GTGN-16...
S20-CNR3DT	STEEL	1.450	1.250	0.788	10.000	1.900	-	1.188	1.219	15	GTGN-16...

- Shim is used for both right and left hand toolholders.
- A clamp set for CNR/L type toolholders consists of a clamp and a clamping screw. • A shim set for CNR/L type toolholders consists of a shim and a shim fixing screw.
- Standard shims for CNR/L type toolholders are commonly used for right and left hand toolholders.
- When using the GTGN insert, the exclusive shim must be used. Exclusive shim should be ordered separately.

SPARE PARTS

Designation	Clamp set	Clamping screw	Shim screw	Shim (Optional parts)	Wrench	Wrench 1
S**-CNR3DT	CSP16	CSTB-3.5ST	DTS5-3.5	(G16EL/IR-DT)	P-3.5	T-15F

Reference pages

SNR/L-2/3: Inserts → **B418** -, Standard cutting conditions → **B416**

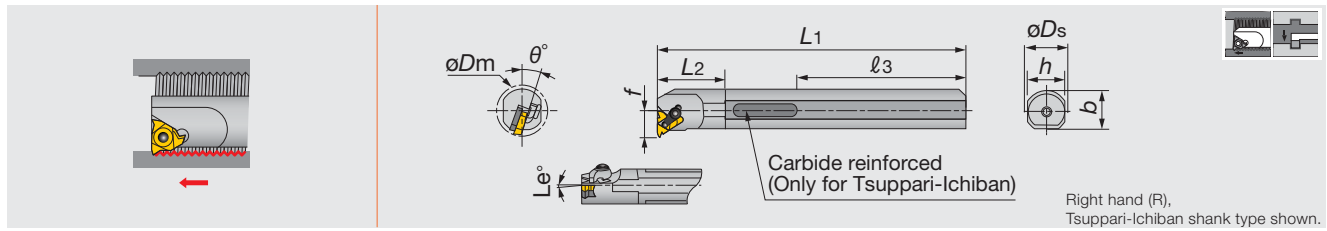

Metric	Material	ϕD_m	ϕD_s	f	L_1	L_2	ℓ_3	h	b	θ°	L_e°	Insert
TCNR0020R16DT	TSUPPARI	24	20	14	200	30	49	18	-	15	1	16IR...
TCNR0025S16DT	TSUPPARI	29	25	16.5	250	38	64	23	-	15	1	16IR...
TCNR0025S22DT	TSUPPARI	30	25	18.2	250	38	64	23	-	15	1	22IR...
CNR/L0020P16	STEEL	24	20	14	170	30	-	18	19	15	1	16IR/L...
CNR/L0025R16	STEEL	29	25	16.5	200	38	-	23	24	15	1	16IR/L...
CNR/L0032S16	STEEL	37	32	20.1	250	48	-	30	31	15	1	16IR/L...
CNR/L0025R22	STEEL	30	25	18.2	200	38	-	23	24	15	1	22IR/L...
CNR/L0032S22	STEEL	38	32	21.9	250	48	-	30	31	15	1	22IR/L...
CNR0040T27	STEEL	46	40	26.9	300	60	-	37	38.5	10	1	27IR...

Note: A clamp set for CNR/L type toolholders consists of a clamp and a clamping screw. A shim set for CNR/L type toolholders consists of a shim and a shim fixing screw. Standard shims for CNR/L type toolholders are commonly used for right and left hand toolholders. The right hand insert (IR) is used for the right hand toolholder (CNR...) and left hand insert (IL) is used for left hand toolholder (CNL...).

SPARE PARTS									
Designation	Clamp set	Clamping screw	Screw	Shim	Shim set R	Shim set L	Wrench	Wrench 1	Wrench 2
TCNR002**16DT	CSP16	CSTB-3.5ST	DTS5-3.5	A16-1DT	-	-	P-3.5	T-15F	-
TCNR0025S22DT	CSP22	CSTB-4ST	DTS6-4	GX22-1DT	-	-	P-4	T-15F	T-20F
CNR/L**16	CSP16	-	-	-	A16-1	A16-1	-	T-15F	-
CNR/L**22	CSP22	-	-	-	NXN22-1	NXE22-1	-	T-20F	-
CNR0040T27	CSP27	-	-	-	NXN27-1	NXE27-1	P-4	-	-

External threading			
Right hand thread		Left hand thread	
Work rotation	Regular	Work rotation	Reverse
Feed direction	Push	Feed direction	Push
Hand of toolholder	Right	Hand of toolholder	Left
Hand of insert	Right	Hand of insert	Left
Standard shim	①	Standard shim	②
Work rotation	Regular	Work rotation	Reverse
Feed direction	Pull	Feed direction	Pull
Hand of toolholder	Left	Hand of toolholder	Right
Hand of insert	Left	Hand of insert	Right
Standard shim	④	Standard shim	③
Work rotation	Reverse	Work rotation	Regular
Feed direction	Push	Feed direction	Push
Hand of toolholder	Right	Hand of toolholder	Left
Hand of insert	Right	Hand of insert	Left
Standard shim	①	Standard shim	②
Work rotation	Reverse	Work rotation	Regular
Feed direction	Pull	Feed direction	Pull
Hand of toolholder	Left	Hand of toolholder	Right
Hand of insert	Left	Hand of insert	Right
Standard shim	④	Standard shim	③

Internal threading			
Right hand thread		Left hand thread	
Work rotation	Regular	Work rotation	Reverse
Feed direction	Push	Feed direction	Push
Hand of toolholder	Right	Hand of toolholder	Left
Hand of insert	Right	Hand of insert	Left
Standard shim	②	Standard shim	①
Work rotation	Reverse	Work rotation	Regular
Feed direction	Pull	Feed direction	Pull
Hand of toolholder	Left	Hand of toolholder	Right
Hand of insert	Left	Hand of insert	Right
Standard shim	③	Standard shim	④

Standard shim			
No.	New	No.	New
①	A16-1DT	②	A16-1DT
	A16-1		A16-1
	GX22-1DT		GX22-1DT
	NXE22-1		NXN22-1
	NXE27-1		NXN27-1
③	AE16-99DT	④	AN16-99DT
	AE16-99		AN16-99
	GXE22-99DT		GXN22-99DT
	NXE22-99		NXN22-99
	NXE27-99		NXN27-99

Relationship between lead, lead angle and pitch

1. Lead is the axial distance a screw advances in one rotation. In single start screw, the lead is equal to the pitch.
2. The inclination angle of a threaded groove is called lead angle. In screws of the same diameter, the lead angle increases as the pitch increases.
3. The side face of a completed thread groove is called flank. The distance between the crest and the root is called thread height.

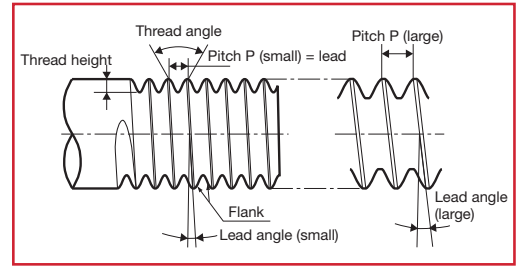

Single and multi start thread

1. The single start thread has a single groove. Two start thread or three start thread has two grooves or three grooves respectively.
2. The pitch of multi start thread is the distance of adjoining groove.
3. When viewing the section of the multi start thread, the pitch is same as that of the single start thread. The lead of the two or three start thread is twice or three times the pitch. The multi start thread is mainly used for trapezoidal threads.

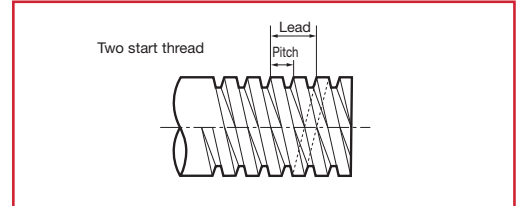

Tolerance class of threads

Tolerance classes of screw threads are expressed as follows:
 Metric coarse external thread: 6h, 6g
 Metric coarse internal thread: 5H, 6H
 These classes are ranked with tolerances of thread diameter, pitch, thread angle, etc. For fastening applications, 6H- and 6g-class (former JIS second class) threads, manufactured

by cutting or rolling, are generally used. 5H- and 4h-class threads (former JIS first class) are generally finished by grinding.
 For example, M8-6g means metric coarse external thread of 6g tolerance class.

TAC threading insert

Difference between full-profile and partial-profile insert

Full-profile insert

In the full-profile insert, the major diameter of the thread is finished by the profiled finishing edge as shown in Figure below. Therefore, about 0.1 mm of finishing stock must be left on the outer surface of the workpiece before threading. In trapezoidal threads, since slants of 15° to 30° are left on the crest of the

thread as shown in Figure below, these portions must be finished by another tool later. Full-profile insert could produce no burr and good thread by the profiled finishing edge.

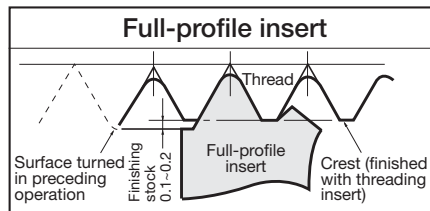
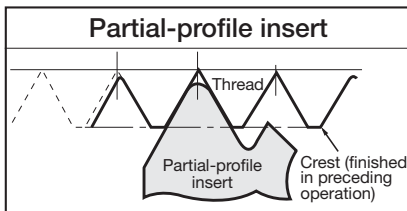

When machining trapezoidal threads:

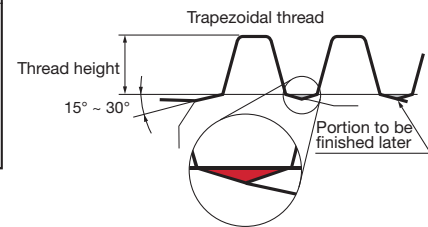

Partial-profile insert

Partial-profile inserts can not be used for finishing of the crest, but can be applied to a wide range of pitches.

For example

Designation	Pitch (mm)	TPI	Insert radius r_ϵ (mm)
16ERA60	0.5 ~ 1.5	48 ~ 16	0.06
16ERG60	1.75 ~ 3	14 ~ 8	0.22

Corner radii of inserts are fitted to the thread of the smallest pitch.

Difference between external and internal use inserts

In full-profile inserts for metric and unified threads, the corner radius and thread height differ from those for the external and internal use insert respectively. Therefore, the right hand insert for external use and the left hand insert for internal use are not the same tool.

Since the rake angles of toolholders are -10° for external toolholders and -15° for internal toolholders, the external / internal toolholders can not be used for machining internal / external thread.

In Whitworth thread, though the external thread and internal thread have the same thread form, the external and internal toolholders are incompatible because of the different rake angle.

For example

Designation	Applicable inserts	Insert radius r_ϵ (mm)	Thread height h (mm)	Rake angle of holders
16ER20ISO	External	0.25	1.52	-10°
16IL20ISO	Internal	0.14	1.3	-15°



Compensation for the lead angle and tool relief angle

When the pitch is large or the screw diameter is small, the lead angle becomes large and the effective relief angle on the advance flank side β_2 becomes small. In particular, this will cause shorter life of the insert in the case of trapezoidal screw with small flank angle. It is ideal without any interference for the thread cutting insert to have an equal relief angle on both right and left. Replace the shim so that the rake face of insert faces the thread groove direction (that is, $\beta = \beta_3$).

Calculating the lead angle

The lead angle is calculated as follows:

$$\beta = \tan^{-1}(\ell / \pi d) = \tan^{-1}(nP / \pi d)$$

β : Lead angle
 ℓ : Lead
 n : No. of threads
 P : Pitch
 d : Pitch diameter

Calculating the relief angle

The relief angle β_1 is calculated as follows:

$$\beta_1 = \tan^{-1}(\tan \theta \cdot \tan \alpha)$$

The α of a standard toolholder is 10° for external threading and 15° for internal threading.

Included angle 2θ	θ	β_1	
		External threading tool	Internal threading tool
60°	30°	5.8°	8.8°
55°	27.5°	5.2°	7.9°
30°	15°	2.7°	4.1°
29°	14.5°	2.6°	4°

Accordingly, the effective relief angle is calculated as follows:

$$\beta_2 = \beta_1 + \beta_3 - \beta$$

β : Lead angle
 β_2 : Effective relief angle
 β_3 : Lead angle compensation value

In other words, $\beta_1 = \beta_2$ when the thread lead angle is equal to the compensation value. Namely, the relief angle of the tool itself is equal to the effective relief angle. If the wrong compensation value is used, $\beta_1 > \beta_2$. The effective relief angle becomes smaller and cause the interference between the flank side of insert and the thread groove. Therefore, carry out compensation of the lead angle so that the following range is obtained:

- $\pm 1^\circ$ when the thread angle is 60° and 55°
- $\pm 30'$ when the thread angle is 30° and 29°

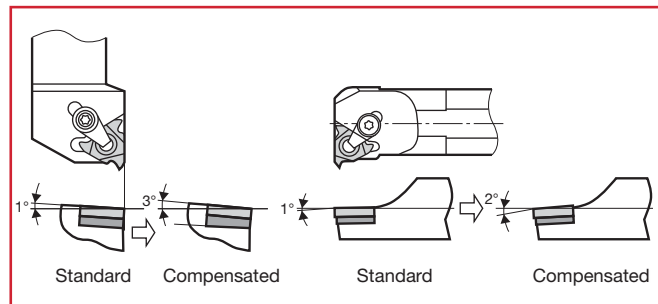
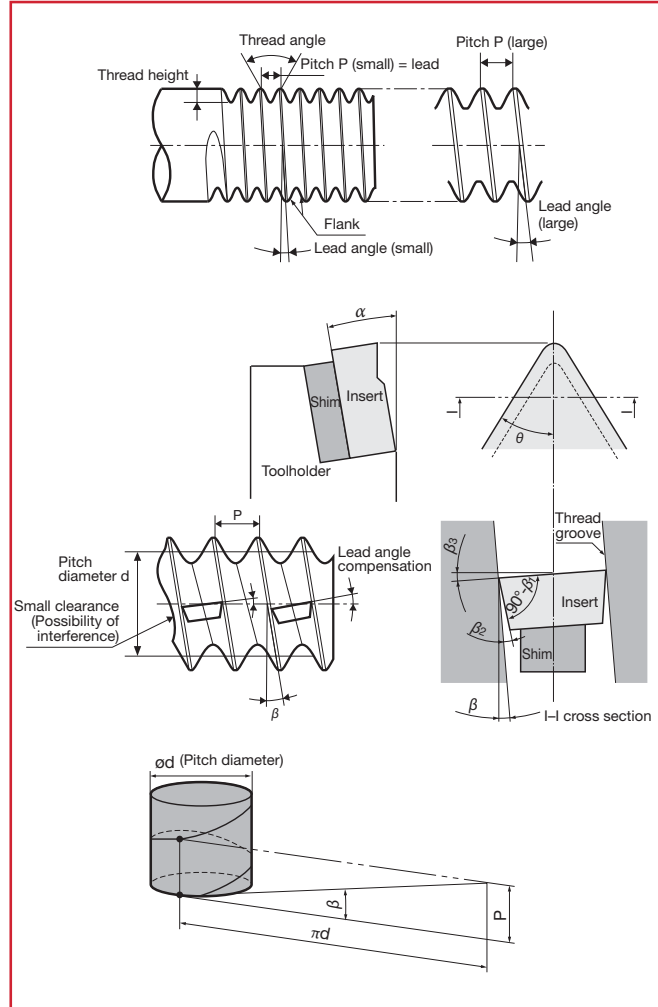

Compensation of lead angle for shim less internal toolholders

When using internal threading toolholders without shim, the above-mentioned method can not be applied for lead angle compensation. Therefore, special toolholders for large lead angles are available as shown below. The final figure of

the designation (-2 or -3) indicates 2° or 3° lead angle to be used respectively. The toolholders without these figures are for 1° lead angle.

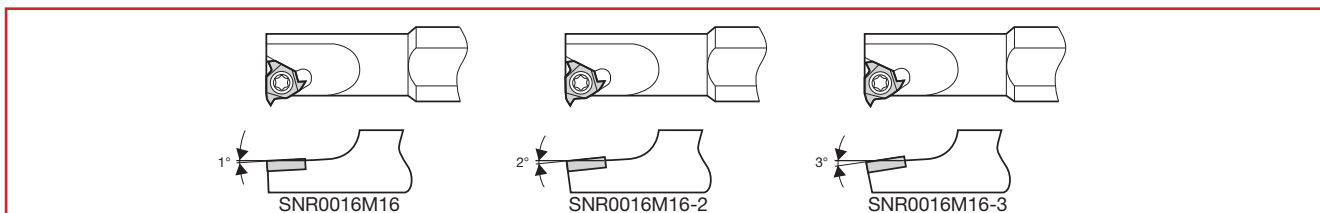

Shim replacement method of ST-type tools

Type of shim and the compensation value of lead angle

The designation of the shim and compensated lead angles are shown in the table.

Compensated lead angles	-2°	-1°	0°	1°	2°	3°	4°
Shim	□□□-98	□□□-99	□□□-0	□□□-1	□□□-2	□□□-3	□□□-4

Note: The last numeral of the shim designation is the compensated lead angle.

Toolholders and applicable shims

Screw-on / clamp-on dual toolholders

Toolholder designation	Shim	
	R	L
CER/L□□□□□16DT	AE16-□DT	AN16-□DT
CER/L□□□□□22DT	GXE22-□DT	GXN22-□DT
TCNR/L□□□□□16DT	AN16-□DT	AE16-□DT
TCNR/L□□□□□22DT	GXN22-□DT	GXE22-□DT

Note: Standard shim is AE16-1DT or GX22-1DT. Other types are optional.

Clamp-on type toolholders

Toolholder designation	Shim	
	R	L
CER/L□□□□□16-T	AE16-□	AN16-□
CER/L□□□□□22-T	NXE22-□	NXN22-□
CER/L□□□□□27-T	NXE27-□	NXN27-□
CNR/L□□□□□16	AN16-□	AE16-□
CNR/L□□□□□22	NXN22-□	NXE22-□
CNR/L□□□□□27	NXN27-□	NXE27-□
B-CER/L□□□□16	AE16-□	AN16-□

Note: Standard shim is □□□□-1. Other types are optional.

Shim selection guide for screw-on / clamp-on dual ST-type tools

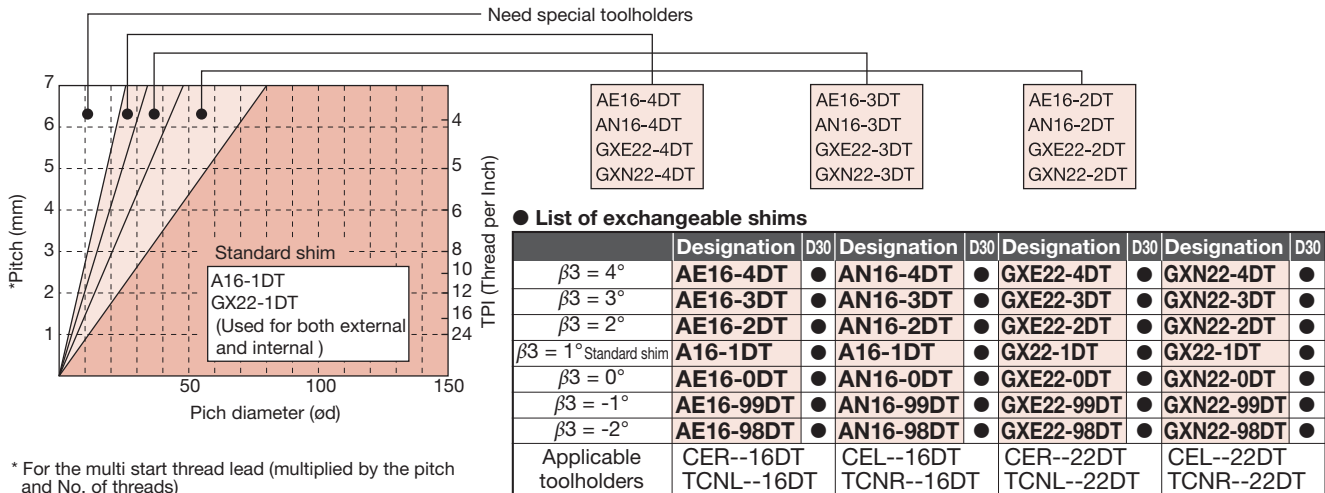

* For the multi start thread lead (multiplied by the pitch and No. of threads)

Shim selection guide for clamp-on type ST-tools

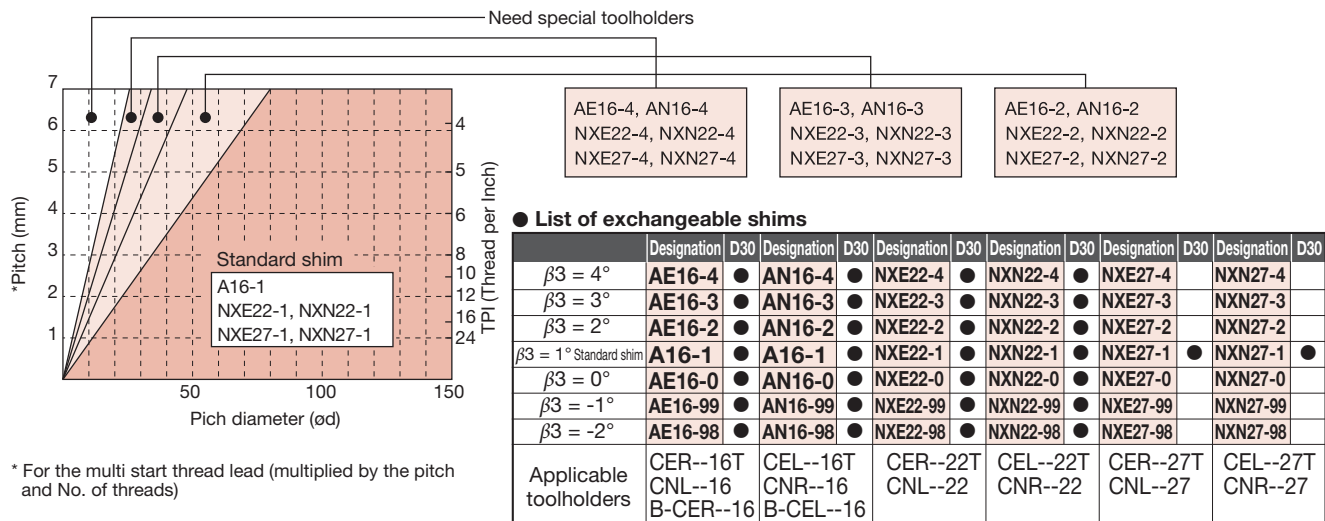

* For the multi start thread lead (multiplied by the pitch and No. of threads)

● : Line up

Selection of internal threading toolholders

Relation between internal toolholders and machinable threads

In the tables starting from next page, the relationships between toolholders, inserts, threads to be machined, and shims to be replaced are shown. In these tables, the criteria are set as follows.

- The minimum machining diameter.
- The L/D ratio of the toolholder.
- The lead angle of the thread.
- Cutting conditions

Especially when machining near the minimum machining diameter, the compensation for the lead angle should be done carefully. Moreover, in threading, because chips generally can not be broken into small pieces, the shank size should be selected in consideration of adequate clearance (C1).

Symbols

- Recommended
- ◻ Usable
- 2 Needs replacing of the shim. "2" indicates "Change to the shim for 2° lead angle".
- Unusable

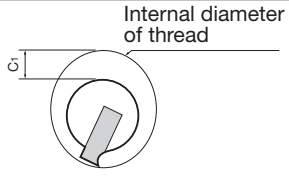
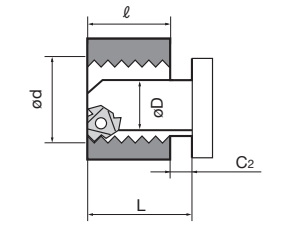
Clearance C ₁		$C_1 \geq 3 \text{ mm}$ (1 mm for 6IR insert holders)
	Overhang ratio L/D	
Carbide shank $L/D \leq 3 \rightarrow \text{○}$		

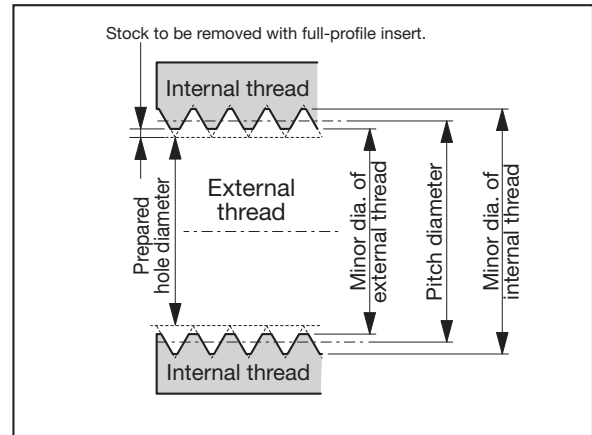

Threading Tool

How to use the tables

- 1 Firstly, find the nominal thread diameter. Example: M35 X 1.5
- 2 The table indicates that the lead angle is 0°48'.
- 3 The Cat. No. of the insert to be used corresponds with IR15ISO.
- 4 By following the row to the right, ◻ and ○ marks are found. The ○ mark indicates the optimum toolholder type. The toolholders of ◻ mark are usable, but less rigid because the shank diameter against the threading diameter is smaller than those of ○ marked toolholder. In this example, CNR0025R16 and TCNR0020R16DT are the optimum toolholders. The insert Cat.No. is 16IR15ISO.
- 5 In the case of M33 X 3 thread, the lead angle is 1°46'. By following the row to the right. 2 mark is found. This indicates that the shim should be replaced to 2° type. For calculation of the lead angle, refer to page B441.

Metric fine screw thread (ISO)

(For full size of this table, see page B445.)

Nominal size	Pitch	Effective diameter	Lead angle	Shank material		Steel shank										Carbide shank					"Tsuppari-Ichiban"																				
				Holder Cat. No.	Insert size										Insert size					Insert size																					
					6IR	11IR	16IR	22IR	6IR	11IR	16IR	16IR	22IR																												
M33×1.5	1.5	32.03	0°51'	IR15ISO	SNR0006H06-2	SNR0006H06-3	SNR0008H06-2	SNR0008H06-3	SNR0010K11	SNR0010K11-2	SNR0013L11	SNR0013L11-2	SNR0016M16	SNR0016M16-2	SNR0020P16	SNR0025R16	CNR0032S16	SNR0020Q22	SNR0020Q22-2	CNR0025R22	CNR0032S22	SNR0006K06SC-2	SNR0006K06SC-3	SNR0008K06SC-2	SNR0008K06SC-3	SNR0010M11SC	SNR0010M11SC-2	SNR0012P11SC	SNR0012P11SC-2	SNR0016R16SC	SNR0016R16SC-2	TSNR0016Q16	TCNR0020R16DT	TCNR0025S16DT	(TCNR0032T16DT)	TSNR0020R22	TCNR0025S22DT				
M33×2	2	31.7	1°09'	IR20ISO	◻	◻	◻	◻	◻	◻	◻	◻	◻	◻	◻	◻	◻	◻	◻	◻	◻	◻	◻	◻	◻	◻	◻	◻	◻	◻	◻	◻	◻	◻	◻	◻	◻	◻	◻		
M33×3	3	31.05	1°46'	IR30ISO	◻	◻	◻	◻	◻	◻	◻	◻	◻	◻	◻	◻	◻	◻	◻	◻	◻	◻	◻	◻	◻	◻	◻	◻	◻	◻	◻	◻	◻	◻	◻	◻	◻	◻	◻	◻	
M35×1.5	1.5	34.03	0°48'	IR15ISO	◻	◻	◻	◻	◻	◻	◻	◻	◻	◻	◻	◻	◻	◻	◻	◻	◻	◻	◻	◻	◻	◻	◻	◻	◻	◻	◻	◻	◻	◻	◻	◻	◻	◻	◻	◻	
M36×1.5	1.5	35.03	0°47'	IR15ISO	◻	◻	◻	◻	◻	◻	◻	◻	◻	◻	◻	◻	◻	◻	◻	◻	◻	◻	◻	◻	◻	◻	◻	◻	◻	◻	◻	◻	◻	◻	◻	◻	◻	◻	◻	◻	
M36×2	2	34.7	1°03'	IR20ISO	◻	◻	◻	◻	◻	◻	◻	◻	◻	◻	◻	◻	◻	◻	◻	◻	◻	◻	◻	◻	◻	◻	◻	◻	◻	◻	◻	◻	◻	◻	◻	◻	◻	◻	◻	◻	
M36×3	3	34.05	1°22'	IR30ISO	◻	◻	◻	◻	◻	◻	◻	◻	◻	◻	◻	◻	◻	◻	◻	◻	◻	◻	◻	◻	◻	◻	◻	◻	◻	◻	◻	◻	◻	◻	◻	◻	◻	◻	◻	◻	
M38×1.5	1.5	37.03	0°47'	IR15ISO	◻	◻	◻	◻	◻	◻	◻	◻	◻	◻	◻	◻	◻	◻	◻	◻	◻	◻	◻	◻	◻	◻	◻	◻	◻	◻	◻	◻	◻	◻	◻	◻	◻	◻	◻	◻	◻

Selection of Internal Toolholders—Relationship between thread sizes, toolholders, and inserts—Part 1

Metric coarse screw thread (ISO)

Nominal size	Pitch (mm)	Pitch diameter (mm)	Lead angle	Shank material Insert size Holder Cat. No. Insert Cat. No.	Steel shank										Carbide shank				*Tsuppari-ichiban*											
					6IR				11IR			16IR		22IR		27IR		6IR		11IR	16IR	22IR								
					SNR0006H06-2	SNR0006H06-3	SNR0008H06-2	SNR0008H06-3	SNR0010K11-2	SNR0010K11-3	SNR0013L11-2	SNR0013L11-3	SNR0016M16-2	SNR0016M16-3	SNR0020Q22-2	SNR0020Q22-3	CNR0025R22	CNR0032S22	(CNR0040T22)	CNR0040T27	(CNR0050U27)	SNR0006K06SC-2	SNR0006K06SC-3	SNR0008K06SC-2	SNR0008K06SC-3	SNR0010M11SC-2	SNR0010M11SC-3	SNR0016R16SC-2	SNR0016R16SC-3	TCNR0025S22DT
M10	1.5	9.03	3°02'	IR15ISO																										
M11	1.5	10.03	2°44'	IR15ISO		○														○										
M12	1.75	10.86	2°56'	IR175ISO		○														○										
M14	2	12.7	2°52'	IR20ISO		•		○												•		○								
M16	2	14.7	2°29'	IR20ISO	•		○													•		○								
M18	2.5	16.38	2°47'	IR25ISO																	○									
M20	2.5	18.38	2°29'	IR25ISO																	○									
M22	2.5	20.38	2°14'	IR25ISO																	○									
M24	3	22.05	2°29'	IR30ISO																	○									
M27	3	25.05	2°11'	IR30ISO																						○				
M30	3.5	27.73	2°18'	IR35ISO																										
M33	3.5	30.73	2°05'	IR35ISO																										
M36	4	33.4	2°11'	IR40ISO																										
M39	4	36.4	2°00'	IR40ISO																										
M42	4.5	39.08	2°06'	IR45ISO																										
M45	4.5	42.08	1°57'	IR45ISO																										
M48	5	44.75	2°02'	IR50ISO																										
M52	5	48.75	1°52'	IR50ISO																										
M56	5.5	52.43	1°55'	IR55ISO																										
M60	5.5	56.43	1°47'	IR55ISO																										
M64	6	60.1	1°49'	IR60ISO																										
M68	6	64.1	1°42'	IR60ISO																										

② : Change the shim to NXN22-2 ←

② : Change the shim to NXN27-2 ←

② : Change the shim to GXN22-2DT ←

Metric fine screw thread (ISO)

Nominal size	Pitch (mm)	Pitch diameter (mm)	Lead angle	Shank material Insert size Holder Cat. No. Insert Cat. No.	Steel shank										Carbide shank															
					6IR				11IR						6IR			11IR												
					SNR0006H06-2	SNR0006H06-3	SNR0008H06-2	SNR0008H06-3	SNR0010K11	SNR0010K11-2	SNR0010K11-3	SNR0013L11	SNR0013L11-2	SNR0013L11-3	SNR0006K06SC-2	SNR0006K06SC-3	SNR0008K06SC-2	SNR0008K06SC-3	SNR0010M11SC	SNR0010M11SC-2	SNR0010M11SC-3	SNR0012P11SC	SNR0012P11SC-2	SNR0012P11SC-3						
M9×0.75	0.75	8.51	1°36'	IR075ISO																										
M9×1	1	8.32	2°11'	IR10ISO																										
M10×0.75	0.75	9.51	1°26'	IR075ISO																										
M10×1	1	9.35	1°57'	IR10ISO	○																○									
M10×1.25	1.25	9.19	2°29'	IR125ISO																										
M11×0.75	0.75	10.51	1°18'	IR075ISO																										
M11×1	1	10.35	1°46'	IR10ISO	○																○									
M12×1	1	11.35	1°36'	IR10ISO	•		○														•		○							
M12×1.25	1.25	11.19	2°02'	IR125ISO	○																○									
M12×1.5	1.5	11.03	2°29'	IR15ISO	○																○									
M14×1	1	13.35	1°22'	IR10ISO																										
M14×1.25	1.25	13.19	1°44'	IR125ISO	•		○														•		○							
M14×1.5	1.5	13.03	2°06'	IR15ISO	•		○														•		○							
M15×1	1	14.35	1°16'	IR10ISO																										
M15×1.5	1.5	14.03	1°57'	IR15ISO	•		○														•		○							
M16×1	1	15.35	1°11'	IR10ISO																										
M16×1.5	1.5	15.03	1°49'	IR15ISO	•		○														•		○							
M17×1	1	16.35	1°07'	IR10ISO																										
M17×1.5	1.5	16.03	1°42'	IR15ISO	•		•														•		○							
M18×1	1	17.35	1°03'	IR10ISO																										
M18×1.5	1.5	17.03	1°36'	IR15ISO	•		•														•		○							
M18×2	2	16.7	2°11'	IR20ISO	•		•														•		○							
M20×1	1	19.35	0°57'	IR10ISO																										
M20×1.5	1.5	19.03	1°26'	IR15ISO																										
M20×2	2	18.7	1°57'	IR20ISO	•		•														•		○							

Note : The above tables show correspondence of internal toolholders at the time of setting clearance between thread and toolholder to 3 mm (1 mm in case of SN type) and the finishing stock to 0.1 mm.

Metric fine screw thread (ISO)

Table with columns for Nominal size, Pitch, Pitch diameter, Lead angle, Shank material (Steel shank, Carbide shank), and Holder Cat. No. (IR15ISO, IR20ISO, IR30ISO, IR40ISO, etc.).

Unified coarse screw thread (UNC)

Table with columns for Nominal size, TPI, Pitch diameter, Lead angle, Shank material (Steel shank, Carbide shank), and Holder Cat. No. (IR14UN, IR13UN, IR12UN, IR11UN, IR10UN, etc.).

Change the shim to NXN22-2 ... Change the shim to GXN22-2DT ... Change the shim to NXN27-2

Note : The above tables show correspondence of internal toolholders at the time of setting clearance between thread and toolholder to 3 mm (1 mm in case of SN type) and the finishing stock to 0.1 mm.

Unified fine screw thread (UNF)

Nominal size	TPI	Pitch diameter (in)	Lead angle	Shank material		Steel shank										Carbide shank						"Tsuppari-Ichiban"						
				Insert size Holder Cat. No.	Insert Cat. No.	6IR			11IR			16IR				6IR			11IR			16IR		16IR				
						SNR0006H06-2	SNR0006H06-3	SNR0008H06-2	SNR0008H06-3	SNR0010K11-2	SNR0013L11-2	SNR0016M16	SNR0016M16-2	CNR0020P16	CNR0025R16	SNR0006K06SC-2	SNR0006K06SC-3	SNR0008K06SC-2	SNR0008K06SC-3	SNR0010M11SC	SNR0010M11SC-2	SNR0012P11SC	SNR0012P11SC-2	SNR0016R16SC	SNR0016R16SC-2	TSNR0016Q16	TCNR0020R16DT	TCNR0025S16DT
IR24UN	IRA60	IR20UN	IRA60	IR20UN	IRA60	IR18UN	IRA60	IR18UN	IRA60	IR16UN	IR14UN	IR12UN	IR12UN	IR12UN	IR12UN	IR12UN	IR12UN	IR12UN	IR12UN	IR12UN	IR12UN	IR12UN	IR12UN	IR12UN	IR12UN	IR12UN		
3/8-24UNF	24	0.3479	2°11'																									
7/16-20UNF	20	0.4050	2°15'																									
1/2-20UNF	20	0.4675	1°57'																									
9/16-18UNF	18	0.5264	1°55'																									
5/8-18UNF	18	0.5889	1°43'																									
3/4-16UNF	16	0.7094	1°36'																									
7/8-14UNF	14	0.8286	1°34'																									
1-12UNF	12	0.9459	1°36'																									
1 1/8-12UNF	12	1.0709	1°25'																									
1 1/4-12UNF	12	1.1959	1°16'																									
1 3/8-12UNF	12	1.3209	1°09'																									
1 1/2-12UNF	12	1.4459	1°03'																									

Unified extra fine screw thread (UNEF)

Nominal size	TPI	Pitch diameter (in)	Lead angle	Shank material		Steel shank										Carbide shank						"Tsuppari-Ichiban"							
				Insert size Holder Cat. No.	Insert Cat. No.	6IR			11IR			16IR				6IR			11IR			16IR		16IR					
						SNR0006H06-2	SNR0008H06-2	SNR0010K11	SNR0010K11-2	SNR0013L11	SNR0013L11-2	SNR0016M16	SNR0016M16-2	CNR0020P16	CNR0025R16	CNR0032S16	SNR0006H06SC-2	SNR0008H06SC-2	SNR0010K11	SNR0010K11-2	SNR0012L11	SNR0012L11-2	SNR0016M16	SNR0016M16-2	TSNR0016Q16	TCNR0020R16DT	TCNR0025S16DT		
																												IR32UN	IR28UN
IR32UN	IR28UN	IR28UN	IR24UN	IR24UN	IR20UN	IR20UN	IR20UN	IR20UN	IR20UN	IR18UN	IR18UN	IR18UN	IR18UN	IR18UN	IR18UN	IR18UN	IR18UN	IR18UN	IR18UN	IR18UN	IR18UN	IR18UN	IR18UN	IR18UN	IR18UN	IR18UN	IR18UN	IR18UN	
3/8	32	0.3547	1°61'																										
7/16	28	0.4143	1°57'																										
1/2	28	0.4768	1°37'																										
9/16	24	0.5354	1°42'																										
5/8	24	0.5979	1°27'																										
11/16	24	0.6604	1°15'																										
3/4	20	0.7175	1°27'																										
13/16	20	0.7800	1°17'																										
7/8	20	0.8425	1°08'																										
15/16	20	0.9050	1°01'																										
1	20	0.9675	0°94'																										
1 1/16	18	1.0264	0°99'																										
1 1/8	18	1.0889	0°93'																										
1 3/16	18	1.1514	0°88'																										
1 1/4	18	1.2139	0°84'																										
1 5/16	18	1.2764	0°79'																										
1 3/8	18	1.3389	0°76'																										
1 7/16	18	1.4014	0°72'																										
1 1/2	18	1.4639	0°69'																										
1 9/16	18	1.5264	0°66'																										
1 5/8	18	1.5889	0°64'																										
1 11/16	18	1.6514	0°61'																										

Note : The above tables show correspondence of internal toolholders at the time of setting clearance between thread and toolholder to 3 mm (1 mm in case of SN type) and the finishing stock to 0.1 mm.



Selection of ST-type Toolholders

Whitworth British Standard (BSW)

Nominal size	TPI	Pitch diameter (in)	Lead angle	Shank material		Steel shank								Carbide shank		"Tsupari-Ichiban"					
				Insert size	Holder Cat. No.	16IR				22IR				16IR		16IR		22IR			
						SNR0016M16	SNR0016M16-2	SNR0016M16-3	CNR0020P16	CNR0025R16	CNR0032S16	SNR0020Q22	SNR0020Q22-2	SNR0020Q22-3	CNR0025R22	CNR0032S22	SNR0016M16	SNR0016M16-2	TSNR0016Q16	TCNR0020R16DT	TCNR0025S16DT
7/16	14	0.3918	3°32'	IR14W																	
1/2	12	0.4466	3°40'	IR12W																	
9/16	12	0.5091	2°98'	IR12W																	
5/8	11	0.5668	2°92'	IR11W																	
11/16	11	0.6293	2°63'	IR11W																	
3/4	10	0.6860	2°66'	IR10W																	
7/8	9	0.8039	2°52'	IR9W																	
1	8	0.9200	2°48'	IR8W																	
1 1/8	7	1.0335	2°52'	IR7W																	
1 1/4	7	1.1585	2°25'	IR7W								○									
1 1/2	6	1.3933	2°18'	IR6W								○									
1 3/4	5	1.6219	2°25'	IR5W								•									②

② : Change the shim to NXN22-2 ←

② : Change the shim to GXN22-2DT ←

Whitworth British Standard Fine (BSF)

Nominal size	TPI	Pitch diameter (in)	Lead angle	Shank material		Steel shank								Carbide shank		"Tsupari-Ichiban"							
				Insert size	Holder Cat. No.	6IR		11IR		16IR				22IR		6IR		16IR	16IR		22IR		
						SNR0006H06-2	SNR0008H06-2	SNR0010K11	SNR0010K11-2	SNR0016M16	SNR0016M16-2	SNR0016M16-3	CNR0020P16	CNR0025R16	SNR0020Q22	SNR0020Q22-2	SNR0020Q22-3	CNR0025R22	CNR0032S22	SNR0006H06SC-2	SNR0008H06SC-2	SNR0016M16	SNR0016M16-2
7/16	18	0.4019	2°52'	IR18W																			
1/2	16	0.4600	2°48'	IR16W	○										○								
9/16	16	0.5225	2°18'	IR16W	•	○									•	○							
5/8	14	0.5793	2°25'	IR14W																			
11/16	14	0.6418	2°03'	IR14W				○															
3/4	12	0.6966	2°18'	IR12W																			
7/8	11	0.8168	2°03'	IR11W																			
1	10	0.9360	1°95'	IR10W						○													
1 1/8	9	1.0539	1°92'	IR9W						○									○				
1 1/4	9	1.1789	1°72'	IR9W					•		②								○		②		
1 3/8	8	1.2950	1°76'	IR8W					•		②								○		②		
1 1/2	8	1.4200	1°61'	IR8W					•		•	②							○		•	②	
1 5/8	8	1.5450	1°48'	IR8W				•		•	○							○		•	•	○	
1 3/4	7	1.6585	1°57'	IR7W								○		②								②	
2	7	1.9085	1°37'	IR7W								•			•	○						•	○
2 1/4	6	2.1433	1°42'	IR6W								•			•	○						•	○
2 1/2	6	2.3933	1°27'	IR6W								•			•	○						•	○
2 3/4	6	2.6433	1°15'	IR6W								•			•	○						•	○
3	5	2.8719	1°27'	IR5W								•			•	○						•	○
3 1/4	5	3.1219	1°17'	IR5W								•			•	○						•	○

② : Change the shim to AN16-2 ←

② : Change the shim to NXN22-2 ←

② : Change the shim to AN16-2DT ←

② : Change the shim to GXN22-2DT ←

Note : The above tables show correspondence of internal toolholders at the time of setting clearance between thread and toolholder to 3 mm (1 mm in case of SN type) and the finishing stock to 0.1 mm.

30° trapezoidal thread (TR)

Nominal size	Pitch (mm)	Pitch diameter (mm)	Lead angle	Shank material Insert size Holder Cat. No. Insert Cat. No.	Steel shank												Carbide shank			"Tsuppari-Ichiban"							
					16IR						22IR						27IR		16IR			16IR		22IR			
					SNR0016M16	SNR0016M16-2	SNR0016M16-3	CNR0020P16	CNR0025R16	CNR0032S16	CNR0040T16	CNR0050U16	SNR0020Q22	SNR0020Q22-2	SNR0020Q22-3	CNR0025R22	CNR0032S22	CNR0040T27	(CNR0050U27)	SNR0016R16SC	SNR0016R16SC-2	(SNR0016R16SC-3)	TSNR0016Q16	TCNR0020R16DT	TCNR0025S16DT	(TCNR0032T16DT)	TSNR0020R22
TR22x3	3	20.5	2°40'	IR30TR																							
TR24x5	5	21.5	4°14'	IR50TR																							
TR24x3	3	22.5	2°26'	IR30TR																							
TR26x5	5	23.5	3°52'	IR50TR																							
TR26x3	3	24.5	2°14'	IR30TR		○																					
TR28x5	5	25.5	3°34'	IR50TR																							
TR28x3	3	26.5	2°04'	IR30TR		•											○										
TR30x6	6	27	4°03'	IR60TR																							
TR30x3	3	28.5	1°55'	IR30TR		•											○										
TR32x6	6	29	3°46'	IR60TR																							
TR32x3	3	30.5	1°48'	IR30TR		•		2									•				2						
TR34x6	6	31	3°32'	IR60TR																							
TR34x3	3	32.5	1°41'	IR30TR		•		2									•				2						
TR36x6	6	33	3°19'	IR60TR																							
TR36x3	3	34.5	1°35'	IR30TR		•		2	2							•				2	2						
TR38x3	3	36.5	1°30'	IR30TR		•		2	2							•				2	2						
TR40x3	3	38.5	1°25'	IR30TR	•			•	○							○				•	○						
TR42x3	3	40.5	1°21'	IR30TR	•			•	○							○				•	○						
TR44x3	3	42.5	1°17'	IR30TR	•			•	•	○						○				•	•	○					
TR46x3	3	44.5	1°14'	IR30TR	•			•	•	○						○				•	•	○					
TR48x3	3	46.5	1°11'	IR30TR	•			•	•	○						○				•	•	○					
TR50x3	3	48.5	1°08'	IR30TR	•			•	•	○						○				•	•	○					
TR52x3	3	50.5	1°05'	IR30TR	•			•	•	○						○				•	•	○					
TR55x3	3	53.5	1°01'	IR30TR	•			•	•	○						○				•	•	○					
TR60x3	3	58.5	0°56'	IR30TR	•			•	•	○						○				•	•	○					

2 : Change the shim to AN16-2 ←

2 : Change the shim to AN16-2DT ←

30° trapezoidal thread (TR)

Nominal size	Pitch (mm)	Pitch diameter (mm)	Lead angle	Shank material Insert size Holder Cat. No. Insert Cat. No.	Steel shank												Carbide shank			"Tsuppari-Ichiban"								
					16IR						22IR						27IR		16IR			16IR		22IR				
					SNR0016M16	SNR0016M16-2	SNR0016M16-3	CNR0020P16	CNR0025R16	CNR0032S16	SNR0020Q22	SNR0020Q22-2	SNR0020Q22-3	CNR0025R22	CNR0032S22	(CNR0040T22)	(CNR0050U22)	(CNR0063V22)	CNR0040T27	(CNR0050U27)	(CNR0063V27)	SNR0016R16SC	SNR0016R16SC-2	(SNR0016R16SC-3)	TSNR0016Q16	TCNR0020R16DT	TCNR0025S16DT	(TCNR0032T16DT)
TR65x4	4	63	1°09'	IR40TR																								
TR70x4	4	68	1°04'	IR40TR																								
TR75x4	4	73	1°00'	IR40TR																								
TR80x4	4	78	0°56'	IR40TR																								
TR85x4	4	83	0°53'	IR40TR																								
TR90x4	4	88	0°50'	IR40TR																								
TR95x4	4	93	0°47'	IR40TR																								
TR100x4	4	98	0°45'	IR40TR																								
TR105x4	4	103	0°42'	IR40TR																								
TR110x4	4	108	0°41'	IR40TR																								
TR115x6	6	112	0°59'	IR60TR																								
TR120x6	6	117	0°56'	IR60TR																								
TR125x6	6	122	0°54'	IR60TR																								
TR130x6	6	127	0°52'	IR60TR																								
TR135x6	6	132	0°50'	IR60TR																								
TR140x6	6	137	0°48'	IR60TR																								
TR145x6	6	142	0°46'	IR60TR																								
TR150x6	6	147	0°45'	IR60TR																								
TR155x6	6	152	0°43'	IR60TR																								
TR160x6	6	157	0°42'	IR60TR																								
TR165x6	6	162	0°41'	IR60TR																								
TR170x6	6	167	0°39'	IR60TR																								

Note : The above tables show correspondence of internal toolholders at the time of setting clearance between thread and toolholder to 3 mm (1 mm in case of SN type) and the finishing stock to 0.1 mm.



Selection of ST-type Toolholders

Parallel pipe thread (G) This table is also applied to PF, Rp, and PS type threads.

Nominal size	TPI	Pitch (in)	Pitch diameter (mm)	Lead angle	Shank material Insert size Holder Cat. No. Insert Cat. No.	Steel shank											Carbide shank						"Tsuppari-Ichiban"									
						6IR			11IR			16IR					6IR			11IR			16IR	16IR								
						SNR0008H06-2	SNR0008H06-3	SNR0010K11	SNR0010K11-2	SNR0013L11	SNR0013L11-2	SNR0016M16	SNR0016M16-2	CNR0020P16	CNR0025R16	CNR0032S16	(CNR0040T16)	(CNR0050U16)	SNR0006K06SC-2	SNR0006K06SC-3	SNR0008K06SC-2	SNR0008K06SC-3	SNR0010M11SC	SNR0010M11SC-2	SNR0012P11SC	SNR0012P11SC-2	SNR0016R16SC	SNR0016R16SC-2	TSNR0016Q16	TCNR0020R16DT	TCNR0025S16DT	(TCNR0032T16DT)
						•	○		•	○									•	○			•	○			•	○	•	○	•	○
G1/4	19	0.053	12.30	1°59'	IR19W	•	○									•	○															
G3/8	19	0.053	15.81	1°33'	IR19W	•	•									•		○														
G1/2	14	0.071	19.79	1°40'	IR14W			•	○										•		○											
G5/8	14	0.071	21.75	1°31'	IR14W			•		○									•			○										
G3/4	14	0.071	25.28	1°18'	IR14W			•			○								•		•		○		•	○						
G7/8	14	0.071	29.04	1°08'	IR14W			•		•									•		•		○		•	○						
G1	11	0.091	31.77	1°20'	IR11W						•	○								•			○		•	•	○					
G1-1/8	11	0.091	36.42	1°09'	IR11W						•		○										○		•	•	○					
G1-1/4	11	0.091	40.43	1°02'	IR11W						•		○										○		•	•	○					
G1-1/2	11	0.091	46.32	0°55'	IR11W						•	•	○										○		•	•	•	○				
G1-3/4	11	0.091	52.27	0°48'	IR11W						•	•	•	○									○		•	•	•	○				
G2	11	0.091	58.14	0°43'	IR11W						•	•	•	○									○		•	•	•	○				
G2-1/4	11	0.091	64.23	0°39'	IR11W						•	•	•	•	○								○		•	•	•	○				
G2-1/2	11	0.091	73.71	0°34'	IR11W						•	•	•	•	○								○		•	•	•	○				
G2-3/4	11	0.091	80.06	0°32'	IR11W						•	•	•	•	○								○		•	•	•	○				
G3	11	0.091	86.41	0°29'	IR11W						0	0	0	0	○												0	0	○			
G3-1/2	11	0.091	98.85	0°26'	IR11W						0	0	0	0	○												0	0	○			
G4	11	0.091	111.55	0°23'	IR11W						0	0	0	0	○												0	0	○			
G4-1/2	11	0.091	124.25	0°20'	IR11W						0	0	0	0	○												0	0	○			
G5	11	0.091	136.95	0°18'	IR11W						0	0	0	0	○												0	0	○			
G6	11	0.091	162.35	0°16'	IR11W						0	0	0	0	○												0	0	○			

○ : Change the shim to AN16-0

○ : Change the shim to AN16-ODT

Taper pipe thread (PT) This table is also applied to Rc type pipe thread.

Nominal size	TPI	Pitch (in)	Pitch diameter (mm)	Lead angle	Shank material Insert size Holder Cat. No. Insert Cat. No.	Steel shank											Carbide shank						"Tsuppari-Ichiban"									
						6IR			11IR			16IR					6IR			11IR			16IR	16IR								
						SNR0008H06-2	SNR0008H06-3	SNR0010K11	SNR0010K11-2	SNR0013L11	SNR0013L11-2	SNR0016M16	SNR0016M16-2	CNR0020P16	CNR0025R16	CNR0032S16	(CNR0040T16)	(CNR0050U16)	SNR0006K06SC-2	SNR0006K06SC-3	SNR0008K06SC-2	SNR0008K06SC-3	SNR0010M11SC	SNR0010M11SC-2	SNR0012P11SC	SNR0012P11SC-2	SNR0016R16SC	SNR0016R16SC-2	TSNR0016Q16	TCNR0020R16DT	TCNR0025S16DT	(TCNR0032T16DT)
						•	○		•	○									•	○			•	○			•	○	•	○	•	○
PT1/4	19	0.053	12.30	1°59'	IR19PT	○										○																
PT3/8	19	0.053	15.81	1°33'	IR19PT	•	○									•		○														
PT1/2	14	0.071	19.79	1°40'	IR14PT					○										•		○										
PT3/4	14	0.071	25.28	1°19'	IR14PT						○									•		•		○		•	○					
PT1	11	0.091	31.77	1°20'	IR11PT							•	○											○		•	○					
PT1 1/4	11	0.091	40.43	1°02'	IR11PT							•	•	○										○		•	•	○				
PT1 1/2	11	0.091	46.32	0°55'	IR11PT							•	•	•	○									○		•	•	•	○			
PT2	11	0.091	58.14	0°43'	IR11PT							•	•	•	•	○								○		•	•	•	○			
PT2 1/2	11	0.091	73.71	0°34'	IR11PT							•	•	•	•	○								○		•	•	•	○			
PT3	11	0.091	86.41	0°29'	IR11PT							0	0	0	0	○											0	0	○			
PT3 1/2	11	0.091	98.85	0°26'	IR11PT							0	0	0	0	○											0	0	○			
PT4	11	0.091	111.55	0°23'	IR11PT							0	0	0	0	○											0	0	○			
PT5	11	0.091	136.95	0°18'	IR11PT							0	0	0	0	○											0	0	○			
PT6	11	0.091	162.35	0°16'	IR11PT							0	0	0	0	○											0	0	○			
PT7	11	0.091	187.75	0°13'	IR11PT							0	0	0	0	○											0	0	○			
PT8	11	0.091	213.15	0°12'	IR11PT							0	0	0	0	○											0	0	○			
PT9	11	0.091	238.55	0°11'	IR11PT							0	0	0	0	○											0	0	○			
PT10	11	0.091	263.95	0°10'	IR11PT							0	0	0	0	○											0	0	○			
PT12	11	0.091	314.75	0°08'	IR11PT							0	0	0	0	○											0	0	○			

○ : Change the shim to AN16-0

○ : Change the shim to AN16-ODT

Note : The above tables show correspondence of internal toolholders at the time of setting clearance between thread and toolholder to 3 mm (1 mm in case of SN type) and the finishing stock to 0.1 mm.

National taper pipe thread (NPT)

Nominal size	TPI	Pitch (in)	Lead angle	Shank material		Steel shank										Carbide shank						"Tsuppari-Ichiban"															
				Insert size	Holder Cat. No.	6IR				16IR						6IR			16IR			16IR															
						Insert Cat. No.	SNR0006H06-2	SNR0006H06-3	SNR0008H06-2	SNR0008H06-3	SNR0016M16	SNR0016M16-2	SNR0016M16-3	CNR0020P16	CNR0025R16	CNR0032S16	(CNR0040T16)	(CNR0050U16)	SNR0006K06SC-2	SNR0006K06SC-3	SNR0008K06SC-2	SNR0008K06SC-3	SNR0016R16SC	SNR0016R16SC-2	(SNR0016R16SC-3)	TSNR0016Q16	TCNR0020R16DT	TCNR0025S16DT	(TCNR0032T16DT)								
3/8NPT	18	0.056	1°37'	IR18NPT	•		○											•		○																	
1/2NPT	14	0.071	1°40'	IR14NPT																																	
3/4NPT	14	0.071	1°19'	IR14NPT																																	
1NPT	11.5	0.087	1°17'	IR115NPT																																	
1 1/4NPT	11.5	0.087	1°00'	IR115NPT																																	
1 1/2NPT	11.5	0.087	0°52'	IR115NPT																																	
2NPT	11.5	0.087	0°41'	IR115NPT																																	
2 1/2NPT	8	0.125	0°50'	IR8NPT																																	
3NPT	8	0.125	0°40'	IR8NPT																																	
3 1/2NPT	8	0.125	0°35'	IR8NPT																																	
4NPT	8	0.125	0°31'	IR8NPT																																	
5NPT	8	0.125	0°25'	IR8NPT																																	
6NPT	8	0.125	0°21'	IR8NPT																																	
8NPT	8	0.125	0°16'	IR8NPT																																	
10NPT	8	0.125	0°13'	IR8NPT																																	
12NPT	8	0.125	0°11'	IR8NPT																																	
14NPT	8	0.125	0°10'	IR8NPT																																	
16NPT	8	0.125	0°09'	IR8NPT																																	
18NPT	8	0.125	0°08'	IR8NPT																																	
20NPT	8	0.125	0°07'	IR8NPT																																	
24NPT	8	0.125	0°06'	IR8NPT																																	

○ : Change the shim to AN16-0 ←

○ : Change the shim to AN16-0DT ←

29° trapezoidal thread (ACME)

Nominal size	TPI	Pitch (in)	Pitch diameter (in)	Lead angle	Shank material		Steel shank										Carbide shank			"Tsuppari-Ichiban"																	
					Insert size	Holder Cat. No.	16IR					22IR					27IR		16IR	16IR	22IR																
							Insert Cat. No.	SNR0016M16	SNR0016M16-2	SNR0016M16-3	CNR0020P16	CNR0025R16	CNR0032S16	SNR0020Q22	SNR0020Q22-2	SNR0020Q22-3	CNR0025R22	CNR0032S22	CNR0040T27	(CNR0050U27)	SNR0016R16SC	SNR0016R16SC-2	SNR0016R16SC-3	TSNR0016Q16	TCNR0020R16DT	TCNR0025S22DT	(TCNR0032T22DT)										
3/8	12	0.083	0.3333	4°33'	IR12ACME																																
7/16	12	0.083	0.3958	3°50'	IR12ACME																																
1/2	10	0.100	0.4500	4°03'	IR10ACME																																
5/8	8	0.125	0.5625	4°03'	IR8ACME																																
3/4	6	0.167	0.6667	4°33'	IR6ACME																																
7/8	6	0.167	0.7917	3°50'	IR6ACME																																
1	5	0.200	0.9000	4°03'	IR5ACME																																
1-1/8	5	0.200	1.0250	3°33'	IR5ACME																																
1-1/4	5	0.200	1.1500	3°10'	IR5ACME																																
1-3/8	4	0.250	1.2500	3°39'	IR4ACME																																
1-1/2	4	0.250	1.3750	3°19'	IR4ACME																																
1-3/4	4	0.250	1.6250	2°48'	IR4ACME																																
2	4	0.250	1.8750	2°26'	IR4ACME																																

Because this thread standard is characterized with large pitch and small diameter, (that is a large lead angle) the standard inserts and toolholders can not be used for machining this thread type. The application is limited to outside of the standard.

Note : The above tables show correspondence of internal toolholders at the time of setting clearance between thread and toolholder to 3 mm (1 mm in case of SN type) and the finishing stock to 0.1 mm.

Threading guidelines

Determine the infeed per pass and number of threads whilst referring to the table and description below.

Pitch (mm)	0.5	0.75	1	1.25	1.5	1.75	2	2.5	3	3.5	4	4.5	5 ~
TPI	48	32	24	20	16	14	12	10	8	7	6	5.5	5 ~
No. of passes	4 ~ 6	4 ~ 7	4 ~ 8	5 ~ 9	6 ~ 10	7 ~ 12	7 ~ 12	8 ~ 14	10 ~ 16	11 ~ 18	11 ~ 18	11 ~ 19	12 ~ 24



Note:

- When using the full-profile insert, set the total infeed amount by taking the finish stock of 0.1mm into account.
- Set the first infeed to 150 ~ 200% of nose R and do not allow it to exceed 0.5 mm (0.020").
- The infeed amount during the final pass must be a minimum of 0.05 mm. No zero cuts should be made. (Extra small infeed or

zero cutting of work hardened surfaces will reduce tool life.)

- The partial-profile insert or inside diameter insert has small nose R. Reduce the infeed per pass and increase the no. of passes.
- Regarding standard infeed per passes and no. of passes, please refer to our catalogue.

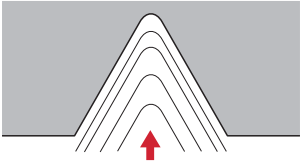
Infeed methods for threading tools

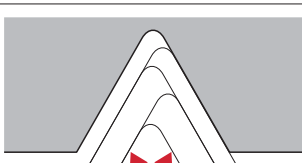
Infeed method	Features
 <p>Straight infeed (radial infeed)</p>	<ul style="list-style-type: none"> • Most simple and usual method • Suitable for relatively small pitch threads of easily machinable material. • Chip contact length on right and left is longer, causing chattering, with increased load on the nose end. • When the half included angle is not symmetrical to the right and left, infeeding in the direction of 1/2 of the included angle will ensure equal machining with right and left cutting edges.
 <p>Single edge infeed (flank infeed)</p>	<ul style="list-style-type: none"> • Suitable for large pitch threads or easy to tear materials. Effectively prevents chattering. • Chips are discharged in one direction only. Satisfactory chip control. • Edge on the right (with zero infeed) tends to be worn heavily.
 <p>Modified single-edge infeed (flank infeed)</p>	<ul style="list-style-type: none"> • Suitable for large pitch threads or easy to tear materials. Effectively prevents chattering. • Chips are discharged in one direction only. Satisfactory chip control. • Edge on the right performs some cutting, therefore wear of this edge can thus be suppressed.
 <p>Alternating flank infeed</p>	<ul style="list-style-type: none"> • Suitable for large pitch threads or easy to tear material. Effectively prevents chattering. • Chips are discharged alternately in right and left directions, resulting possibly in entanglement. • Right and left edges are used alternately, ensuring uniform wear and extending tool life.

Infeed per Pass and Number of Passes

30° Trapezoidal (TR) inserts

Pitch	For external					For internal					
	2	3	4	5	6	2	3	4	5	6	
Height of thread	1.25	1.75	2.25	2.75	3.5	1.25	1.75	2.25	2.75	3.5	
Total depth of cut	1.35	1.85	2.35	2.85	3.6	1.35	1.85	2.35	2.85	3.6	
Number of passes	1	0.25	0.25	0.3	0.3	0.3	0.2	0.22	0.25	0.25	0.25
	2	0.2	0.22	0.25	0.25	0.25	0.18	0.2	0.22	0.22	0.22
	3	0.2	0.2	0.22	0.2	0.23	0.18	0.18	0.2	0.2	0.21
	4	0.18	0.18	0.2	0.2	0.2	0.16	0.16	0.2	0.18	0.2
	5	0.15	0.17	0.18	0.18	0.18	0.15	0.16	0.17	0.18	0.18
	6	0.12	0.16	0.16	0.16	0.18	0.13	0.16	0.16	0.16	0.18
	7	0.1	0.14	0.15	0.16	0.16	0.1	0.14	0.16	0.16	0.16
	8	0.1	0.14	0.14	0.15	0.16	0.1	0.14	0.14	0.15	0.16
	9	0.05	0.12	0.14	0.14	0.16	0.1	0.12	0.14	0.14	0.16
	10		0.12	0.12	0.14	0.16	0.05	0.12	0.12	0.14	0.16
	11		0.1	0.12	0.14	0.16		0.1	0.12	0.14	0.16
	12		0.05	0.12	0.12	0.15		0.1	0.12	0.12	0.15
	13			0.1	0.12	0.15		0.05	0.1	0.12	0.15
	14			0.1	0.12	0.15			0.1	0.12	0.15
	15			0.05	0.12	0.14			0.1	0.12	0.14
	16				0.1	0.14			0.05	0.1	0.14
	17				0.1	0.12				0.1	0.12
	18				0.1	0.12				0.1	0.12
	19				0.05	0.12				0.1	0.12
	20					0.12				0.05	0.12
	21					0.1					0.1
	22					0.1					0.1
	23					0.05					0.1
	24										0.05
	25										
	26										

(Unit: mm)

29° Trapezoidal (TR) inserts

TPI	For external			For internal			
	8	6	5	8	6	5	
Height of thread	1.88	2.41	2.92	1.88	2.41	2.92	
Total depth of cut	1.98	2.51	3.02	1.98	2.51	3.02	
Number of passes	1	0.25	0.25	0.25	0.22	0.22	0.22
	2	0.22	0.22	0.22	0.2	0.2	0.2
	3	0.2	0.2	0.2	0.18	0.18	0.18
	4	0.18	0.18	0.18	0.16	0.18	0.18
	5	0.16	0.17	0.18	0.16	0.16	0.16
	6	0.16	0.16	0.16	0.16	0.15	0.16
	7	0.16	0.16	0.16	0.15	0.15	0.15
	8	0.14	0.14	0.14	0.14	0.14	0.14
	9	0.14	0.14	0.14	0.14	0.14	0.14
	10	0.12	0.14	0.14	0.12	0.14	0.14
	11	0.1	0.14	0.14	0.1	0.14	0.14
	12	0.1	0.12	0.14	0.1	0.12	0.14
	13	0.05	0.12	0.12	0.1	0.12	0.12
	14		0.12	0.12	0.05	0.12	0.12
	15		0.1	0.12		0.1	0.12
	16		0.1	0.12		0.1	0.12
	17		0.05	0.12		0.1	0.12
	18			0.12		0.05	0.12
	19			0.1			0.1
	20			0.1			0.1
	21			0.05			0.1
	22						0.05
	23						
	24						
	25						
	26						

(Unit: mm)

PT full-profile inserts

TPI	For external				For internal			
	28	19	14	11	19	14	11	
Height of thread	0.6	0.86	1.16	1.48	0.86	1.16	1.48	
Total depth of cut	0.7	0.96	1.26	1.58	0.96	1.26	1.58	
Number of passes	1	0.25	0.28	0.3	0.3	0.22	0.25	0.25
	2	0.2	0.2	0.25	0.25	0.2	0.22	0.22
	3	0.1	0.18	0.2	0.22	0.18	0.18	0.18
	4	0.1	0.15	0.15	0.18	0.16	0.14	0.18
	5	0.05	0.1	0.11	0.15	0.1	0.12	0.15
	6		0.05	0.1	0.12	0.05	0.1	0.13
	7			0.1	0.11	0.05	0.1	0.12
	8			0.05	0.1		0.1	0.1
	9				0.1		0.05	0.1
	10				0.05			0.1
	11							0.05
	12							
	13							
	14							
	15							
	16							
	17							
	18							
	19							
	20							
	21							
	22							
	23							
	24							
	25							
	26							

(Unit: mm)

NPT full-profile inserts

TPI	For external				For internal			
	18	14	11.5	8	14	11.5	8	
Height of thread	1.14	1.47	1.79	2.58	1.47	1.79	2.58	
Total depth of cut	1.24	1.57	1.89	2.68	1.57	1.89	2.68	
Number of passes	1	0.2	0.25	0.25	0.3	0.22	0.22	0.25
	2	0.18	0.22	0.22	0.25	0.2	0.2	0.2
	3	0.17	0.2	0.2	0.2	0.18	0.18	0.2
	4	0.16	0.18	0.18	0.2	0.18	0.18	0.2
	5	0.14	0.17	0.18	0.2	0.16	0.16	0.2
	6	0.12	0.16	0.17	0.2	0.14	0.16	0.2
	7	0.12	0.12	0.16	0.18	0.12	0.16	0.18
	8	0.1	0.12	0.14	0.18	0.12	0.14	0.18
	9	0.05	0.1	0.12	0.16	0.1	0.12	0.16
	10		0.05	0.12	0.16	0.1	0.12	0.16
	11			0.1	0.14	0.05	0.1	0.14
	12			0.05	0.14		0.1	0.14
	13				0.12		0.05	0.12
	14				0.1			0.1
	15				0.1			0.1
	16				0.05			0.1
	17							0.05
	18							
	19							
	20							
	21							
	22							
	23							
	24							
	25							
	26							

(Unit: mm)

Designation System for TAC Threading Tools (TT-type)

Insert

TT	R	42	M	-005
①	②	③	④	
① Hand	② Insert size (mm)	③ Thread type	④ Corner radius (mm)	
R Right L Left	Inscribed circle 12.7 Thickness 3.2	M 60° thread angle W 55° thread angle	Blank 0 -005 0.05	

Toolholder

TT-	20	20	R	E
①	②	③	④	
① Shank height (mm)	② Shank width (mm)	③ Hand	④ External or Internal	
		R Right L Left	E External I Internal	

TT-type Insert
60° thread angle

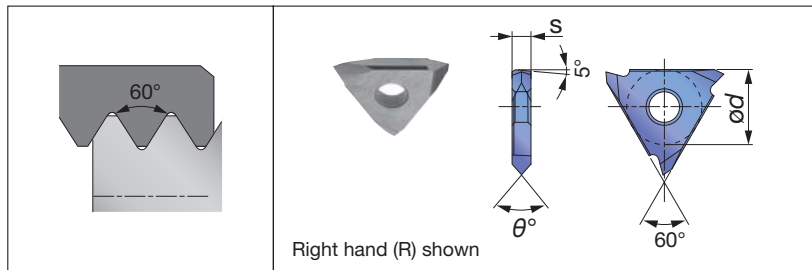

Partial-profile insert for external and internal threads

Pitch (mm)	TPI	Hand of cut	Designation	Grade		ød (mm)	s (mm)	θ°	Applicable toolholders
				Cermet NS9530	Uncoated TH10				
≤ 3	≥ 8	R	TTR42M-005	●	●	12.7	3.2	60	TT-****RE/LI
≤ 3	≥ 8	L	TTL42M-005	●	●	12.7	3.2	60	TT-****LE/RI

TT-type Insert
55° thread angle

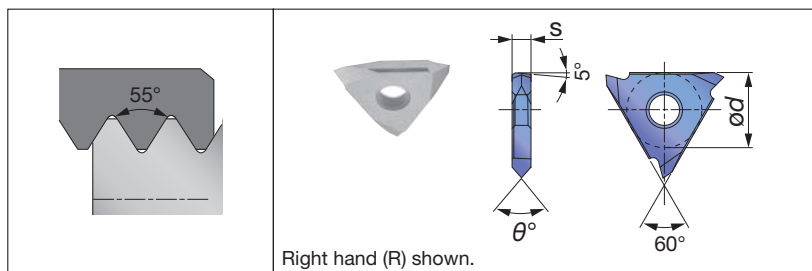

Partial-profile insert for external and internal threads

Pitch (mm)	TPI	Hand of cut	Designation	Grade		ød (mm)	s (mm)	θ°	Applicable toolholders
				Cermet NS9530	Uncoated TH10				
≤ 3	≥ 8	R	TTR42W-005	●	●	12.7	3.2	55	TT-****RE/LI
≤ 3	≥ 8	L	TTL42W-005	●	●	12.7	3.2	55	TT-****LE/RI

● : Line up / Packing Quantity = 5 pcs.

TT-R/LE

"TT type" External threading toolholders, pin lock

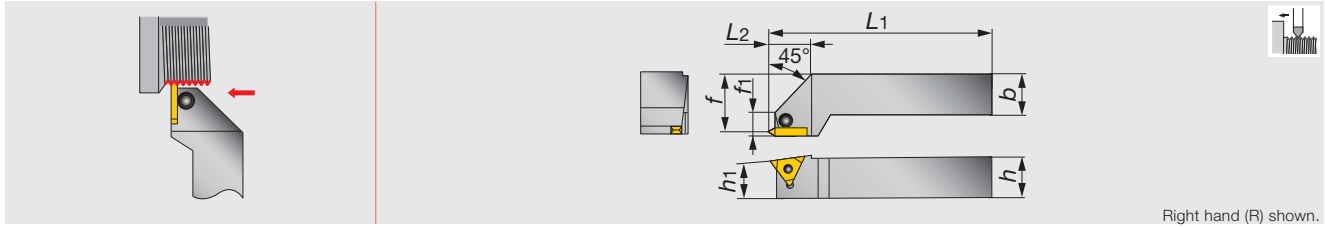

Right hand (R) shown.

Metric	h	b	L1	L2	h1	f	f1	Insert
TT-2525R/LE	25	25	150	25	25	32	15	TTR/L42...

SPARE PARTS

Designation	Clamp	Right-left screw	Wrench
TT-2525R/LE	CP91	DS-6	P-3

TUNGTHREAD

TT-RI

"TT type" Internal threading toolholders, pin lock

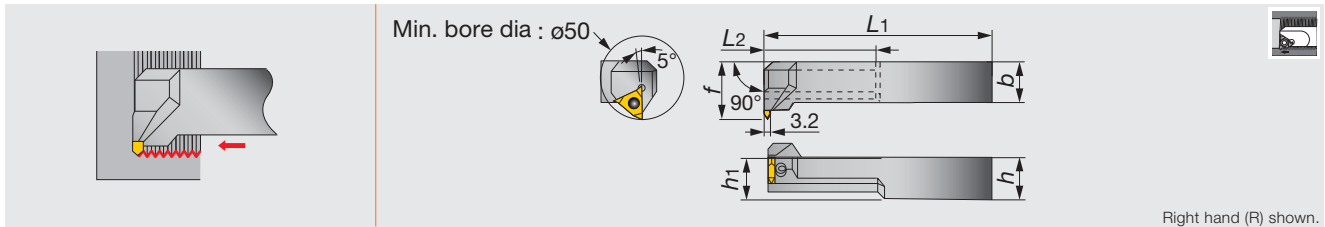

Right hand (R) shown.

Metric	øDm	h	b	L1	L2	h1	f	Insert
TT-2525RI	50	25	25	200	70	25	35	TTL42...

Notes : The left hand insert is used for right hand toolholders.

SPARE PARTS

Designation	Clamp	Right-left screw	Wrench
TT-2525RI	CP91	DS-6	P-3

- Relationship between pitch, depth of cut and number of passes for external metric threading

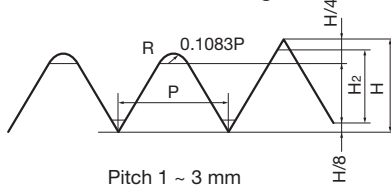

Note: Maximum machinable pitch is 3 mm.

Part assembly

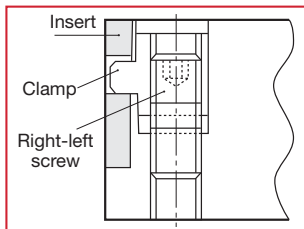

	P	1	1.25	1.5	1.75	2	2.5	3
	H ₂	0.6	0.76	0.92	1.09	1.25	1.57	1.9
	H	0.866	1.083	1.299	1.516	1.732	2.165	2.598
Number of passes	1	0.25	0.3	0.3	0.3	0.35	0.4	0.4
	2	0.15	0.2	0.25	0.25	0.25	0.3	0.35
	3	0.1	0.1	0.15	0.2	0.2	0.25	0.28
	4	0.05	0.06	0.1	0.1	0.16	0.2	0.2
	5	0.05	0.06	0.05	0.1	0.1	0.15	0.2
	6		0.06	0.05	0.07	0.07	0.1	0.13
	7			0.02	0.05	0.05	0.07	0.1
	8				0.02	0.02	0.05	0.1
	9					0.02	0.03	0.05
	10						0.02	0.05
	11							0.02
	12							0.02

(Unit: mm)

Reference pages

TT-R/LE, TT-RI: Inserts → B455

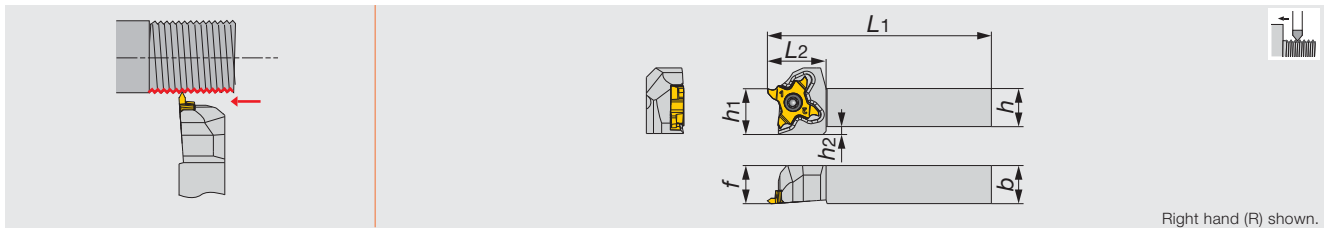

Inch	h	b	$L1$	$L2$	$h1$	f	$h2$	Insert
STCR/L06-18	0.375	0.375	4.75	0.73	0.375	0.375	0.177	TC*18...
STCR/L08-18	0.500	0.500	4.75	0.73	0.500	0.500	0.098	TC*18...
STCR/L10-18	0.625	0.625	4.75	0.73	0.625	0.625	-	TC*18...
STCR/L12-18	0.750	0.750	4.750	0.900	0.750	1.000	-	TC*18...
STCR/L16-18	1.000	1.000	5.500	0.900	1.000	1.250	-	TC*18...

Metric	h	b	$L1$	$L2$	$h1$	f	$h2$	Insert
STCR/L1010X18	10	10	120	18.5	10	10	4.5	TC*18...
STCR/L1212F18	12	12	85	18.5	12	12	2.5	TC*18...
STCR/L1212X18	12	12	120	18.5	12	12	2.5	TC*18...
STCR/L1616X18	16	16	120	18.5	16	16	-	TC*18...
STCR/L2020H18	20	20	100	18.5	20	20	-	TC*18...
STCR/L2020X18	20	20	120	23	20	25	-	TC*18...
STCR/L2525Z18	25	25	135	23	25	30	-	TC*18...

- The right hand insert (TCT18R...) is used for the right hand toolholders (STCR...), and the left hand insert (TCL18...) is used for the left hand toolholders (STCL...).

SPARE PARTS

Designation	Clamping screw	Wrench
STCR...	CSTC-4L100DL	T-1008/5
STCL...	CSTC-4L100DR	T-1008/5



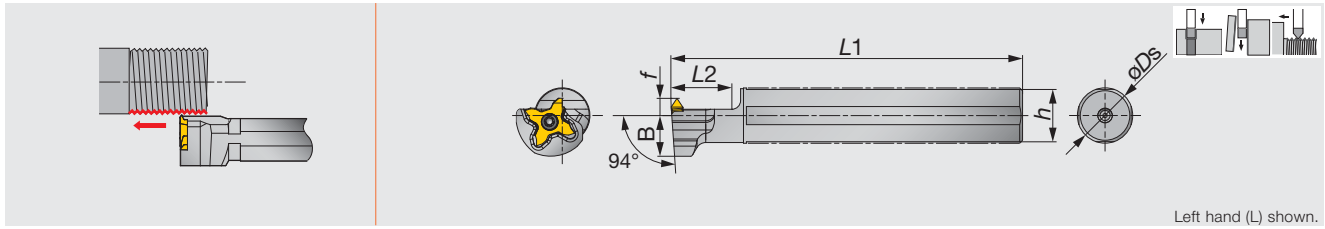

Metric	ϕD_s	L1	L2	h	B	f	Insert
JS14H-STCL18	14	100	20	13	14	6	TC*18R...
JS159F-STCL18	15.875 (0.625")	85	20	15	14	6	TC*18R...
JS16F-STCL18	16	85	20	15	14	6	TC*18R...
JS19G-STCL18	19.05 (0.750")	90	20	18	14	6	TC*18R...
JS19X-STCL18	19.05 (0.750")	120	20	18	14	6	TC*18R...
JS20G-STCL18	20	90	20	19	14	6	TC*18R...
JS20X-STCL18	20	120	20	19	14	6	TC*18R...
JS22X-STCL18	22	120	20	21	12.25	10	TC*18R...
JS25H-STCL18	25	100	20	24	12.25	10	TC*18R...
JS254X-STCL18	25.4 (1.000")	120	20	24	12.25	10	TC*18R...

- The right hand insert (TCT18R...) is used for the left hand toolholders (STCL...)



Threading Tool

SPARE PARTS

Designation	Clamping screw	Wrench
JS**STCL18	CSTC-4L100DL	T-1008/5

Reference pages

JS-STCL18: Inserts, Standard cutting conditions → B459

INSERT

TCT18R/L (For Threading)

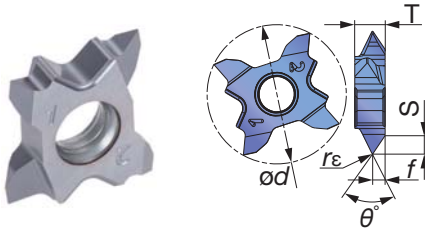

Designation	Coated AH725		Pitch min (mm)	Pitch max (mm)	f (in)	S (in)	r ϵ (in)	θ°	T (in)	ϕd (in)
	R	L								
TCT18R/L-60N-010	●	●	0.8	3	0.063	0.105	0.004	60	0.157	0.709
TCT18R/L-60N-020	●	●	1.5	3	0.063	0.101	0.008	60	0.157	0.709

● : Line up

STANDARD CUTTING CONDITIONS

ISO	Workpiece material	Grade	Cutting speed Vc (sfm)	Pitch (in)	TPI
P	Low carbon steels S15C, S20C, etc. C15, C20, etc.	AH725	197 - 492	0.031 - 0.118	32 - 8
	Carbon steels, Alloy steels S55C, SCM440, etc. C55, 42CrMoS4, etc.	AH725	197 - 492	0.031 - 0.118	32 - 8
	Prehardened steels NAK80, PX5, etc.	AH725	197 - 492	0.031 - 0.118	32 - 8
M	Stainless steels SUS303, SUS316, etc. X5CrNi18-9, X5CrNiMo17-12-2, etc	AH725	164 - 262	0.031 - 0.118	32 - 8
K	Gray cast irons 250, 300, etc.	AH725	164 - 328	0.031 - 0.118	32 - 8
	Ductile cast irons 400-15, 600-3, etc.	AH725	164 - 328	0.031 - 0.118	32 - 8
S	Titanium alloys Ti-6Al-4V, etc.	AH725	98 - 328	0.031 - 0.118	32 - 8
	Superalloys Inconel718, etc.	AH725	98 - 328	0.031 - 0.118	32 - 8



Threading Tool

J-SERIES

JSTTR/L

External threading toolholders for small lathe

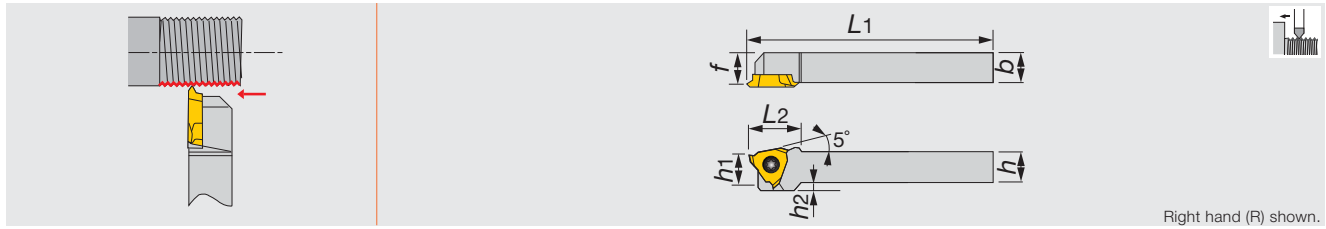

Right hand (R) shown.

Inch	<i>h</i>	<i>b</i>	<i>L1</i>	<i>L2</i>	<i>h1</i>	<i>f</i>	<i>h2</i>	Insert
JSTTR/L063	0.375	0.375	5	0.6875	0.375	0.375	0.100	JTTR/L30...
JSTTR/L083	0.500	0.500	5	0.6875	0.500	0.500	-	JTTR/L30...
JSTTR/L103	0.625	0.625	5	0.6875	0.625	0.625	-	JTTR/L30...

Metric	<i>h</i>	<i>b</i>	<i>L1</i>	<i>L2</i>	<i>h1</i>	<i>f</i>	<i>h2</i>	Insert
JSTTR/L1010X3	10	10	120	18.5	10	9.5	2	JTTR/L30...
JSTTR/L1212F3	12	12	85	18.5	12	11.5	-	JTTR/L30...
JSTTR/L1212X3	12	12	120	18.5	12	11.5	-	JTTR/L30...
JSTTR/L1616X3	16	16	120	16.5	16	15.5	-	JTTR/L30...

Recommend clamping torque: 0.89 lbt-ft (1.2 N·m)

SPARE PARTS

Designation	Clamping screw	Wrench
JSTTR/L...	CSTB-4SD	T-8F

Threading Tool

J-SERIES

JS-TTL3

External threading toolholders for small lathe

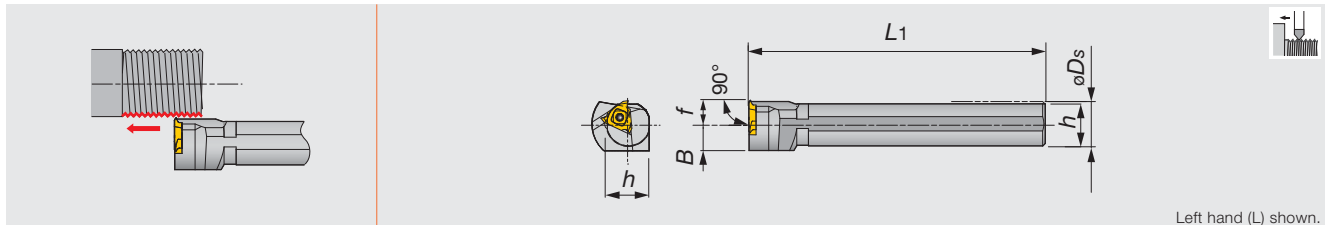

Left hand (L) shown.

Metric	<i>øDs</i>	<i>f</i>	<i>L1</i>	<i>h</i>	<i>B</i>	Insert
JS19K-TTL3	19.05	10	125	18	11.5	JTTR30...
JS20K-TTL3	20	10	125	19	11.5	JTTR30...
JS22K-TTL3	22	10	125	21	11.5	JTTR30...
JS25K-TTL3	25.4	10	125	24	12.7	JTTR30...

Recommend clamping torque: 2.58 lbt-ft (3.5 N·m)

SPARE PARTS

Designation	Clamping screw	Wrench
JS**-TTL3	CSTB-4S	T-15F

Reference pages

JSTTR/L, JS-TTL3: Inserts → **B461**

B460 www.tungaloyamerica.com

INSERT

JTT (sharp edge)

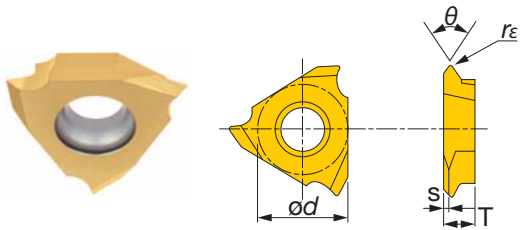

Right hand (R) shown.

Designation	rε (in)	Coated				Cermet		Uncoated		θ°	ød (in)	T (in)	s (in)
		SH725		J740		NS9530		TH10					
		R	L	R	L	R	L	R	L				
JTTR/L3005F-55	0.002	●		●						55	0.375	0.125	0.024
JTTR/L3005F	0.002	●	●	●		●		●		60	0.375	0.125	0.035
JTTR/L3010F	0.004	●	●	●		●		●		60	0.375	0.125	0.035

Machinable pitch range: 0.020" to 0.039".

● : Line up



Threading Tool

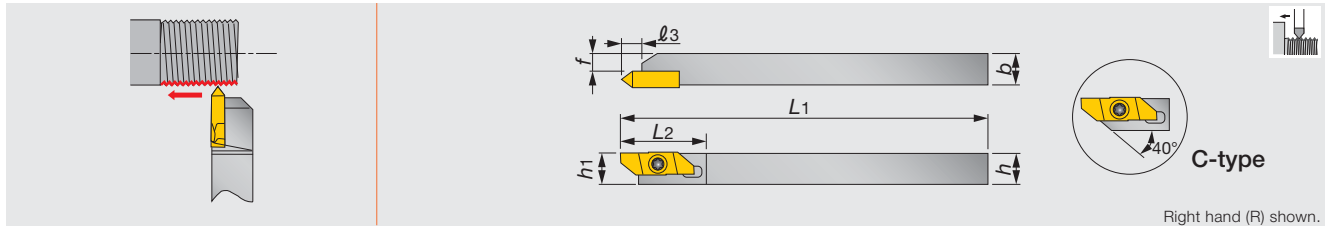

Right hand (R) shown.

Metric	<i>h</i>	<i>b</i>	<i>L</i> ₁	<i>L</i> ₂	<i>l</i> ₃	<i>h</i> ₁	<i>f</i>	Insert
JSXBR1010K8-C	10	10	125	29	6.4	10	5.7	JXT*R...
JSXBR1212K8-C	12	12	125	29	6.4	12	7.7	JXT*R...
JSXBR1616K8	16	16	125	29	6.4	16	11.7	JXT*R...
JSXBR2020K8	20	20	125	29	6.4	20	15.7	JXT*R...
JSXBR2525K8	25	25	125	29	6.4	25	20.7	JXT*R...

- Can be wrenched from back side with both end torx screw.
- This toolholder is also compatible with JSXB-type insert for back turning.

SPARE PARTS

Designation	Clamping screw	Wrench	Wrench (Optional parts)
JSXBR...	CSTB-4SD	T-8F	(T-8L)

INSERT

JXT (sharp edge)

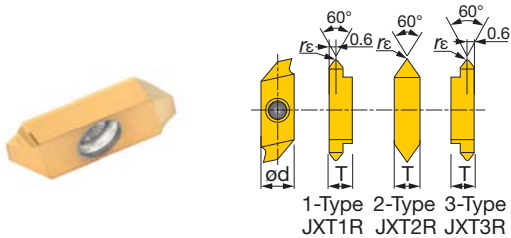

Designation	<i>r</i> _ε (mm)	Coated	Uncoated	<i>θ</i> [°]	ø <i>d</i> (mm)	<i>T</i> (mm)
		J740	TH10			
JXT1R6000F	0.03	●	●	60	8	3.97
JXT2R6000F	0.03	●	●	60	8	3.97

Machinable pitch range: 0.5 to 1 mm

● : Line up

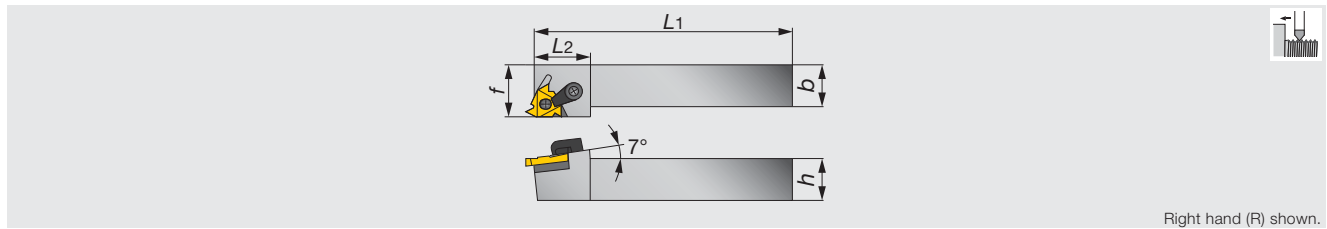

Metric	b	h	L1	L2	f	Insert
MTVNR-2525M5	25	25	152	39	31.8	L53 5B**EXT-FC
MTVNR-3232M5	32	32	178	39	38.1	L53 5B**EXT-FC

SPARE PARTS					
Designation	Shim	Lock pin	Clamp	Clamping screw	Wrench
MTVNR...	LS53NOFORMEXT	NL-58	TC-250	STC-11	1/8HEX



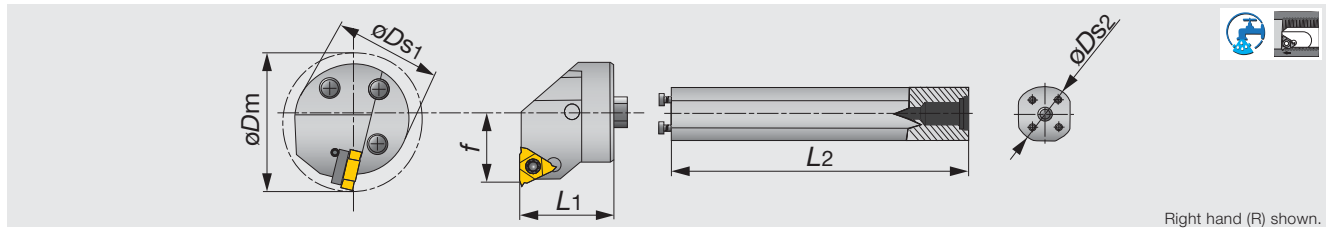

Metric	$\varnothing D_m$	$\varnothing D_{s1}$	f	L_1	Insert
HS40-LNFR-53	50	40	28.7	41.3	L53 5B**INT-FC
HS50-LNFR-53	63	50	32.7	41.3	L53 5B**INT-FC

SPARE PARTS

Designation	Lock pin	Clamp	Clamping screw	Wrench
HS**-LNFR-53	NL-56	TC-250	STC-11	1/8HEX

Shank

Designation	$\varnothing D_{s2}$ (in)	L_2 (in)
S-570-40M-40	1.575	10.75
S-570-50M-50	1.969	14.41

SPARE PARTS

Designation	Clamping screw	Wrench
S-570-40M-40	SS100	5/32HEX
S-570-50M-50	SS94	1/4EX

Full-profile insert (Single-sided)

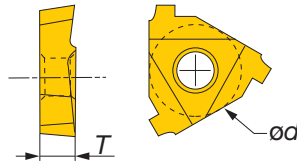

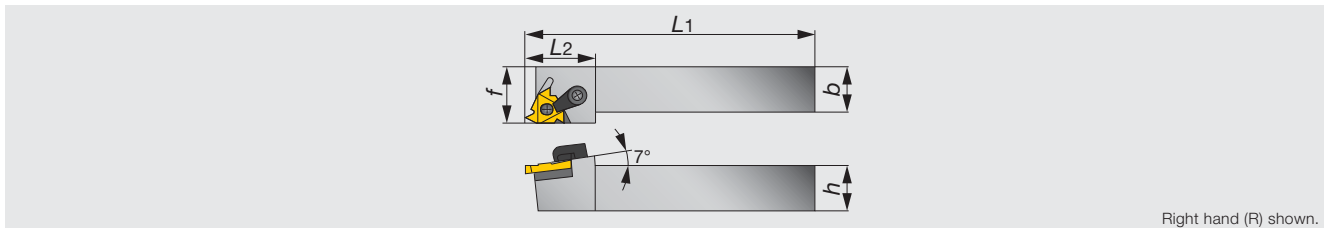

Connection	TPI	Taper		External insert (mm)				Internal insert (mm)			
		mm/mm	TPF	Designation	Grade	$\varnothing d$	T	Designation	Grade	$\varnothing d$	T
					Coated				Coated		
API	5	1/16	0.75	L53 5B75 EXT-FC	●	15.875	4.8	L53 5B75 INT-FC	●	15.875	4.8
Buttress	5	1/12	1	L53 5B1 EXT-FC	●	15.875	4.8	L53 5B1 INT-FC	●	15.875	4.8

● : Line up



Metric	<i>h</i>	<i>b</i>	<i>L1</i>	<i>L2</i>	<i>f</i>	Insert
MTVNR-3232M54	32	32	178	39	38.1	LDS 54**FT-CB#...

SPARE PARTS					
Designation	Shim	Lock pin	Clamp	Clamping screw	Wrench
MTVNR-3232M54	LS53NOFORMEXT	NL-58	TC-250	STC-11	1/8HEX



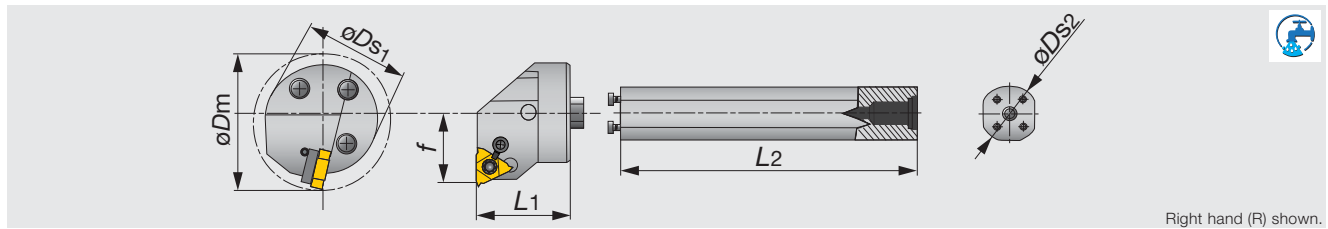

Inch	ϕD_m	ϕD_{s1}	f	L_1	Insert
HS40-LNFR-54API	1.970	1.57	1.063	1.26	LDS 54**FT-CB#...
HS50-LNFR-54API	2.480	1.97	1.378	1.57	LDS 54**FT-CB#...

SPARE PARTS

Designation	Lock pin	Clamp	Clamping screw	Wrench
HS40-LNFR-54API	H410-1	TC-250	STC-11	1/8HEX
HS50-LNFR-54API	NL-56	TC-250	STC-11	1/8HEX

Shank

Designation	ϕD_{s2} (in)	L_2 (in)
S-570-40M-40	1.575	10.75
S-570-50M-50	1.969	14.41

SPARE PARTS

Designation	Clamping screw	Wrench
S-570-40M-40	SS100	5/32HEX
S-570-50M-50	SS94	1/4EX

Full-profile insert (Double-sided)

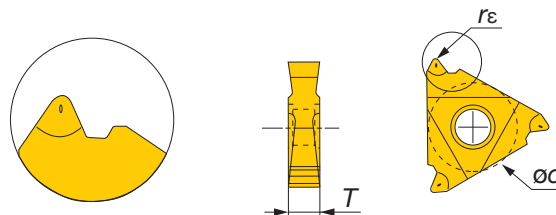

Connection	TPI	Thread form	Taper		Designation	Grade	ϕd (in)	T (in)	r_ϵ (in)
			mm/mm	TPF		Coated			
API Rotary shoulder connection	5	V-0.040	1/4	3	LDS 54 530 FT-CB #5	●	0.625	0.252	0.020
	4	V-0.038R	1/6	2	LDS 54 428 FT-CB #1	●	0.625	0.252	0.038
	4	V-0.038R	1/4	3	LDS 54 438 FT-CB #2	●	0.625	0.252	0.038
	4	V-0.050	1/6	2	LDS 54 425 FT-CB #3	●	0.625	0.252	0.025
	4	V-0.050	1/4	3	LDS 54 435 FT-CB #4	●	0.625	0.252	0.025

● : Line up

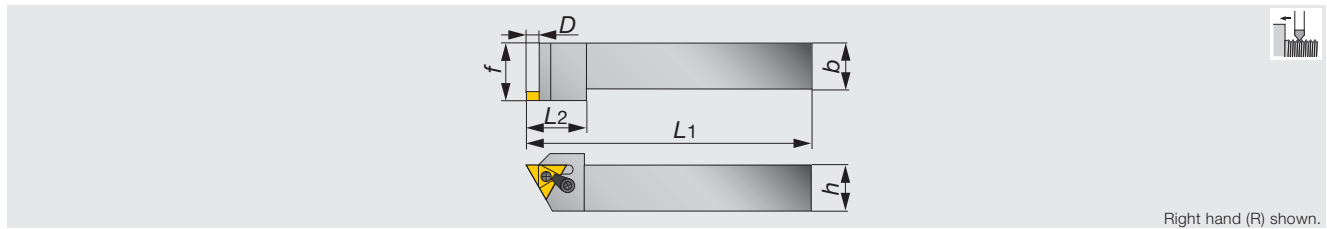

Metric	<i>h</i>	<i>b</i>	<i>L</i> ₁	<i>L</i> ₂	<i>f</i>	<i>D</i>	Insert
MTVOR-2525M4	25	25	152	31	31.7	5.8	TNM*43...
MTVOR-3232M4	32	32	178	31	38.1	5.8	TNM*43...
MTVOR-2525M5	25	25	152	36	31.7	7.3	TNM*54...
MTVOR-3232M5	32	32	178	36	38.1	7.3	TNM*54...

Note: For TNMC inserts, STVOR/L toolholder is recommended. Also, M-Type toolholder is available.

SPARE PARTS



Designation	Lock pin	Clamp	Clamping screw	Wrench
MTVOR-**M4	NL-44	TC-190	STC-5	3/32HEX
MTVOR-**M5	NL-56	TC-250	STC-11	1/8HEX



TUNGTHREAD

STVOR

External screw-on toolholders for on edge inserts

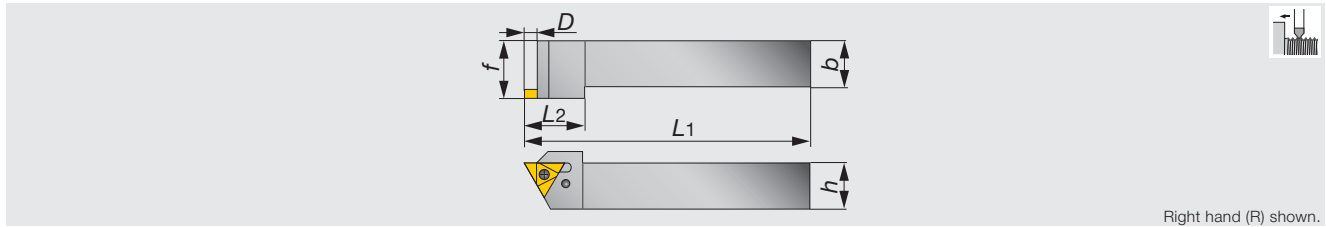

Right hand (R) shown.

Inch	h	b	L1	L2	f	D	Insert
STVOR-2525M4	0.984	0.984	5.91	1.23	1.25	0.23	TNMC43...
STVOR-3232M4	1.260	1.260	7.01	1.23	1.50	0.23	TNMC43...
STVOR-2525M5	0.984	0.984	5.91	1.42	1.25	0.29	TNMC54...
STVOR-3232M5	1.260	1.260	7.00	1.42	1.50	0.29	TNMC54...

SPARE PARTS



Designation	Clamping screw	Clamp (Optional parts)	Clamping screw (Optional parts)	Wrench
STVOR-**M4	SD2	(TC-190)	(STC-9)	T20TORX 3/32HEX
STVOR-**M5	SD3	(TC-250)	(STC-11)	T20TORX 1/8HEX

TUNGTHREAD

HS-MTHOR

Exchangeable internal threading heads, for on edge insert, applicable on S-570 shanks

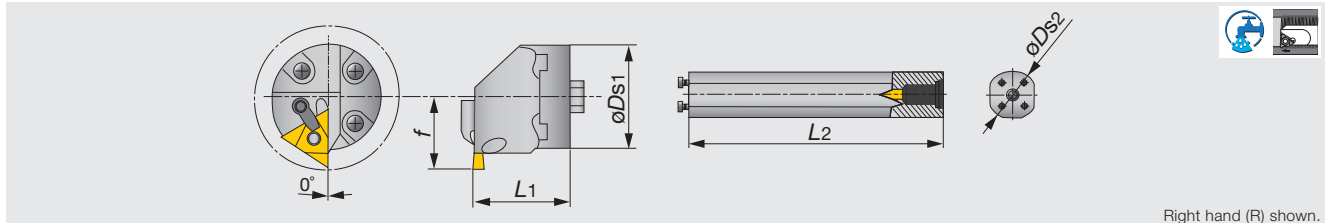

Right hand (R) shown.

Inch	øDm	øDs1	f	L1	Insert
HS40-MTHOR-4	2.625	1.57	1.020	1.26	TNM*43...
HS50-MTHOR-4	2.875	1.97	1.413	1.57	TNM*43...
HS40-MTHOR-5	3.200	1.57	1.203	1.26	TNM*54...
HS50-MTHOR-5	3.250	1.97	1.413	1.57	TNM*54...

SPARE PARTS



Designation	Lock pin	Clamp	Clamping screw	Wrench
HS**-MTHOR-4	NL-44	TC-190	STC-5	3/32HEX
HS**-MTHOR-5	NL-56	TC-250	STC-11	1/8HEX

Shank

Designation	øDs2 (in)	L2 (in)
S-570-40M-40	1.575	10.75
S-570-50M-50	1.969	14.41

SPARE PARTS



Designation	Clamping screw	Wrench
S-570-40M-40	SS100	5/32HEX
S-570-50M-50	SS94	1/4EX

Reference pages

STVOR, HS-MTHOR: Inserts → **B469**

Full profile insert and partial topping insert

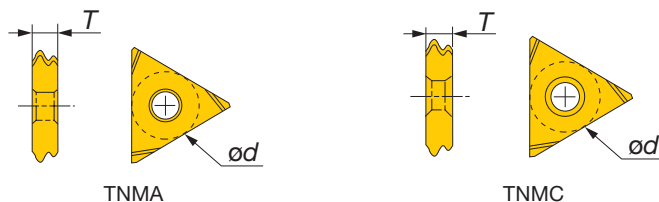

Connection	TPI	Taper		External insert (in)				Internal insert (in)			
		mm/mm	TPF	Designation	Grade	ød	T	Designation	Grade	ød	T
					Coated				Coated		
					AH725				AH725		
API Round	10	1/16	0.75	TNMA 43 10RD EXT	●	0.5	0.189	TNMA 43 10RD INT	●	0.5	0.189
	8	1/16	0.75	TNMA 43 8RD EXT	●	0.5	0.189	TNMA 43 8RD INT	●	0.5	0.189
API Buttress	5	1/12	1	TNMA 54 5B1 EXT-FC	●	0.625	0.252	TNMA 54 5B1 INT-FC	●	0.625	0.252
	5	1/16	0.75	TNMA 54 5B75 EXT-FC	●	0.625	0.252	TNMA 54 5B75 INT-FC	●	0.625	0.252
ACME (29° Trapezoid)	16	-	-	TNMA43NT16PEXT-PT	●	0.5	0.189	-	-	-	-
	14	-	-	TNMA43NT14PEXT-PT	●	0.5	0.189	-	-	-	-
	12	-	-	TNMA43NT12PEXT-PT	●	0.5	0.189	-	-	-	-
	10	-	-	TNMA43NT10PEXT-PT	●	0.5	0.189	-	-	-	-
	8	-	-	TNMA43NT8PEXT-PT	●	0.5	0.189	-	-	-	-
	6	-	-	TNMA43NT6PEXT-PT	●	0.5	0.189	-	-	-	-
	5	-	-	TNMA54NT5PEXT-PT	●	0.625	0.252	-	-	-	-
	4	-	-	TNMA54NT4PEXT-PT	●	0.625	0.252	-	-	-	-
STUB ACME (29° Trapezoid)	16	-	-	TNMA43NT16PSTUBE-PT	●	0.5	0.189	-	-	-	-
	14	-	-	TNMA43NT14PSTUBE-PT	●	0.5	0.189	-	-	-	-
	12	-	-	TNMA43NT12PSTUBE-PT	●	0.5	0.189	-	-	-	-
	10	-	-	TNMA43NT10PSTUBE-PT	●	0.5	0.189	-	-	-	-
	8	-	-	TNMA43NT8PSTUBE-PT	●	0.5	0.189	-	-	-	-
	6	-	-	TNMA43NT6PSTUBE-PT	●	0.5	0.189	-	-	-	-
	5	-	-	TNMA54NT5PSTUBE-PT	●	0.625	0.252	-	-	-	-
	4	-	-	TNMA54NT4PSTUBE-PT	●	0.625	0.252	-	-	-	-
API Round	10	1/16	0.75	TNMC 43 10RD EXT	●	0.5	0.189	TNMC 43 10RD INT	●	0.5	0.189
	8	1/16	0.75	TNMC 43 8RD EXT	●	0.5	0.189	TNMC 43 8RD INT	●	0.5	0.189
API Buttress	5	1/12	1	TNMC 54 5B1 EXT-FC	●	0.625	0.252	TNMC 54 5B1 INT-FC	●	0.625	0.252
	5	1/16	0.75	TNMC 54 5B75 EXT-FC	●	0.625	0.252	TNMC 54 5B75 INT-FC	●	0.625	0.252
ACME (29° Trapezoid)	16	-	-	TNMC43NT16PEXT-PT	●	0.5	0.189	-	-	-	-
	14	-	-	TNMC43NT14PEXT-PT	●	0.5	0.189	-	-	-	-
	12	-	-	TNMC43NT12PEXT-PT	●	0.5	0.189	-	-	-	-
	10	-	-	TNMC43NT10PEXT-PT	●	0.5	0.189	-	-	-	-
	8	-	-	TNMC43NT8PEXT-PT	●	0.5	0.189	-	-	-	-
	6	-	-	TNMC43NT6PEXT-PT	●	0.5	0.189	-	-	-	-
	5	-	-	TNMC54NT5PEXT-PT	●	0.625	0.252	-	-	-	-
	4	-	-	TNMC54NT4PEXT-PT	●	0.625	0.252	-	-	-	-
STUB ACME (29° Trapezoid)	16	-	-	TNMC43NT16PSTUBE-PT	●	0.5	0.189	-	-	-	-
	14	-	-	TNMC43NT14PSTUBE-PT	●	0.5	0.189	-	-	-	-
	12	-	-	TNMC43NT12PSTUBE-PT	●	0.5	0.189	-	-	-	-
	10	-	-	TNMC43NT10PSTUBE-PT	●	0.5	0.189	-	-	-	-
	8	-	-	TNMC43NT8PSTUBE-PT	●	0.5	0.189	-	-	-	-
	6	-	-	TNMC43NT6PSTUBE-PT	●	0.5	0.189	-	-	-	-
	5	-	-	TNMC54NT5PSTUBE-PT	●	0.625	0.252	-	-	-	-
	4	-	-	TNMC54NT4PSTUBE-PT	●	0.625	0.252	-	-	-	-
3	-	-	TNMC54NT3PSTUBE-PT	●	0.625	0.252	-	-	-	-	

• For ACME and STUB-ACME inserts can cut crest radius. Crest flat of ACME and STUB-ACME have to cut by another tool.

● : Line up

Threading Tool

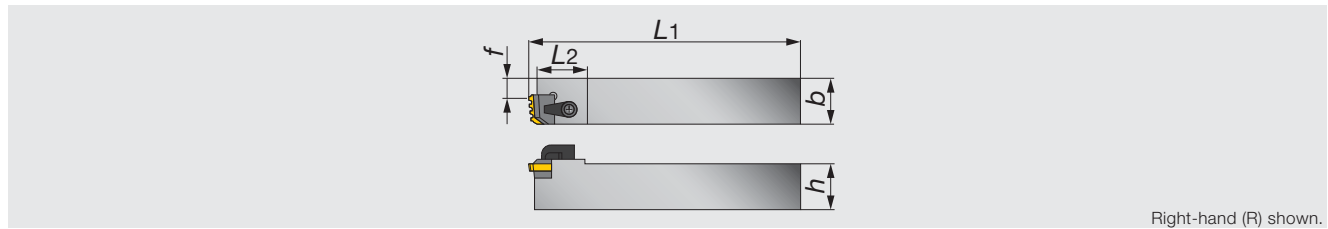

Right-hand (R) shown.

Metric	f	L1	L2	h	b	Insert
CLVOR-25M6	16.1	177.8	32	25	25	CR-8R/10R/11.5NPT/8NPT-3E/4E
CLVOR-32M6	16.1	177.8	32	32	32	CR-8R/10R/11.5NPT/8NPT-3E/4E
CLVOR-40M8	29.8	179.1	32	40	40	CR-5B75-4E

SPARE PARTS



Designation	Shim	Shim screw	Clamp	Clamping screw	Wrench		
CLVOR-25M6	TF1207	SF80	TC-311	STC-4	T-25TORX	-	5/32HEX
CLVOR-32M6	TF1207	SF85	TC-311	STC-4	T-25TORX	-	5/32HEX
CLVOR-40M8	TF8132-E	SF60	TC-311	STC-4	-	T-20TORX	5/32HEX

Full profile insert (chaser)

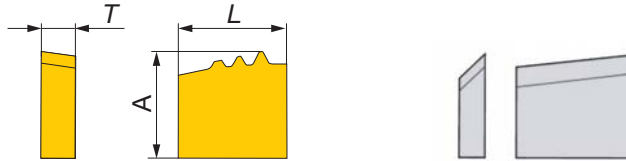

Connection	TPI	Taper		Designation	AH725	L (mm)	A (mm)	T (mm)	Breakerpiece
		mm/mm	TPF						
API Round	8	1/16	0.75	CR-8R-3E	●	16	15	5.2	CR-8R / 10R-3E / 4E-CB
	10	1/16	0.75	CR-10R-3E	●	16	15.9	5.2	CR-8R / 10R-3E / 4E-CB
API Buttress	5	1/16	0.75	CR-5B75-4E	●	20.4	15.9	5.1	CR-5B75 / 5B1-4E-CB
NPT	11.5	1/16	0.75	CR-11.5NPT-4E	●	15.9	15.7	4.76	CR-8R / 10R-3E / 4E-CB
	8	1/16	0.75	CR-8NPT-4E	●	15.9	15.7	5.2	CR-8R / 10R-3E / 4E-CB

Full profile insert (chaser)

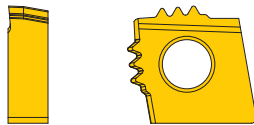

Connection	TPI	Taper		Designation	AH725
		mm/mm	TPF		
API Round	10	1/16	0.75	CNGA-10R-3E	●
	8	1/16	0.75	CNGA-8R-3E	●
API Buttress	5	1/16	0.75	CNGA-5B75-3E	●

Note: Toolholder should be designed and ordered individually.

● : Line up

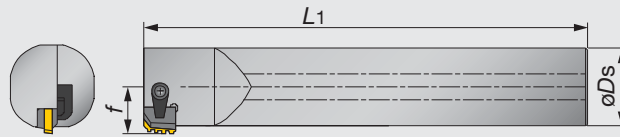

Right-hand (R) shown.

Metric	ϕD_m	ϕD_s	f	L_1	Insert
SI-CLHOR-40M6	50.8	40	23.16	400	CR-**I

SPARE PARTS



Designation	Clamp	Clamping screw	Wrench
SI-CLHOR-40M6	TC-311	STC-8	5/32HEX

Full profile insert (chaser)

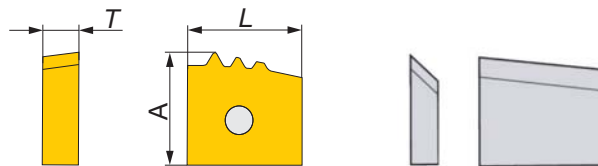

Connection	TPI	Taper		Designation	AH725	L (mm)	A (mm)	T (mm)	Breakerpiece
		mm/mm	TPF						
API Round	8	1/16	0.75	CR-8R-3I	●	16	15	5.1	CR-8R / 10R-3I / 4I-CB
	10	1/16	0.75	CR-10R-3I	●	16	15.9	5.1	CR-8R / 10R-3I / 4I-CB
API Buttress	5	1/16	0.75	CR-5B75-3I	●	16	14.7	5.2	CR-8R / 10R-3I / 4I-CB
NPT	11.5	1/16	0.75	CR-11.5NPT-4I	●	15.9	15.7	4.76	CR-8R / 10R-3I / 4I-CB
	8	1/16	0.75	CR-8NPT-4I	●	15.9	15.7	5.2	CR-8R / 10R-3I / 4I-CB

● : Line up



Threading Tool

CR-3E-#1_3

Chaser inserts for tool rotating machines

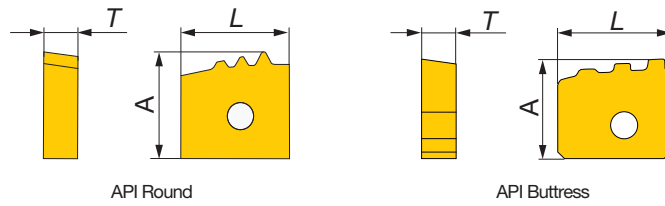

Connection	TPI	Taper		Designation	AH725	L (mm)	A (mm)	T (mm)	Breakerpiece
		mm/mm	TPF						
API Round	8	1/16	0.75	CR-8R-3E #1	●	16	14.7	5.2	TD39318R-1-CBW/CAVITY
	8	1/16	0.75	CR-8R-3E #2	●	16	14.9	5.2	TD39328R-2-CBW/CAVITY
	8	1/16	0.75	CR-8R-3E #3	●	16	15	5.2	TD39338R-3-CBW/CAVITY
API Buttress	5	1/16	0.75	CR-5B75-3E #1	●	17	14.6	5.2	TD46015B75-1-CBW/CAVITY
	5	1/16	0.75	CR-5B75-3E #2	●	17	14.8	5.2	TD46025B75-2-CBW/CAVITY
	5	1/16	0.75	CR-5B75-3E #3	●	17	15	5.2	TD46035B75-3-CBW/CAVITY

● : Line up



Threading Tool

MEMO

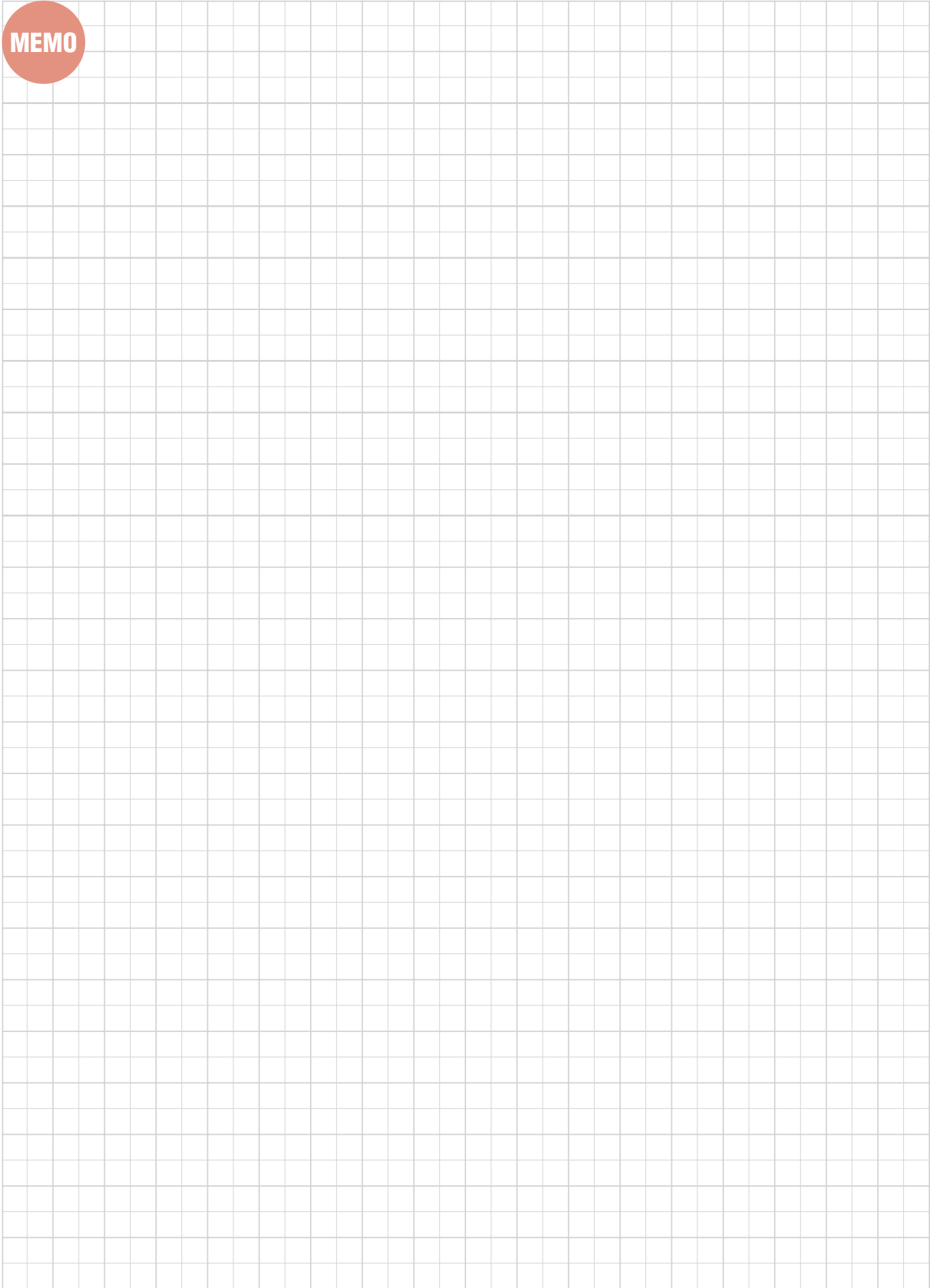

Threading Tool

GrooveLine



PARTING, GROOVING & GROOVE-TURN SYSTEM



Parting, Grooving & Groove-Turn System

C002

GrooveLine - Parting, Grooving & Groove-Turn System

				Inch	Metric
	<p>TETRAFORCE C047</p> <p>4-cornered inserts with good clamping rigidity for highly precise grooving and parting</p> <p> $W = 0.5 - 3.18 \text{ mm (0.020" - 0.125")}$</p>	<input checked="" type="checkbox"/>	<input type="checkbox"/>		
	<p>TETRAMCUT C055</p> <p>Unique insert geometry for highly precise grooving</p> <p>$W = 0.33 - 3.0 \text{ mm (0.013" - 0.118")}$</p>	<input checked="" type="checkbox"/>	<input checked="" type="checkbox"/>		
	<p>DUOJUST C009</p> <p>Innovative clamping system for stable parting operations</p> <p>$W = 1.0 - 2.0 \text{ mm (0.039" - 0.079")}$</p>	<input checked="" type="checkbox"/>	<input checked="" type="checkbox"/>		
	<p>EASYMCUT C125</p> <p>Multi-functional tool series for parting, grooving, and turning</p> <p>  $W = 4.0 - 6.0 \text{ mm (0.157" - 0.236")}$</p>	<input checked="" type="checkbox"/>	<input type="checkbox"/>		
	<p>TUNGHEAVY GROOVE C137</p> <p>Highly rigid clamping system for wide grooving and profiling in one pass</p> <p> $W = 10 - 25 \text{ mm (0.394" - 0.984")}$</p>	<input checked="" type="checkbox"/>	<input type="checkbox"/>		
	<p>TUNGCUT C059</p> <p>Multi-functional tool series for various grooving operations</p> <p>$W = 1.4 - 8.0 \text{ mm (0.055" - 0.315")}$</p>	<input checked="" type="checkbox"/>	<input checked="" type="checkbox"/>		
	<p>MY-T SERIES C092</p> <p>Variety tool series for a wide range of grooving and parting operations</p> <p>$W = 2.0 - 8.0 \text{ mm (0.079" - 0.315")}$</p>	<input checked="" type="checkbox"/>	<input checked="" type="checkbox"/>		
	<p>TUNGT-CLAMP C021</p> <p>G-class inserts with precisely designed chipbreaker for grooving</p> <p>$W = 0.79 - 6.35 \text{ mm (0.031" - 0.250")}$</p>	<input checked="" type="checkbox"/>	<input checked="" type="checkbox"/>		
	<p>GTGENTYPE C044</p> <p>3-cornered inserts for grooving</p> <p>$W = 1.0 - 2.25 \text{ mm (0.039" - 0.089")}$</p>	<input checked="" type="checkbox"/>	<input checked="" type="checkbox"/>		
<p>Other Grooving & Parting Tool C014</p> <p>J-series</p>		<input checked="" type="checkbox"/>	<input checked="" type="checkbox"/>		

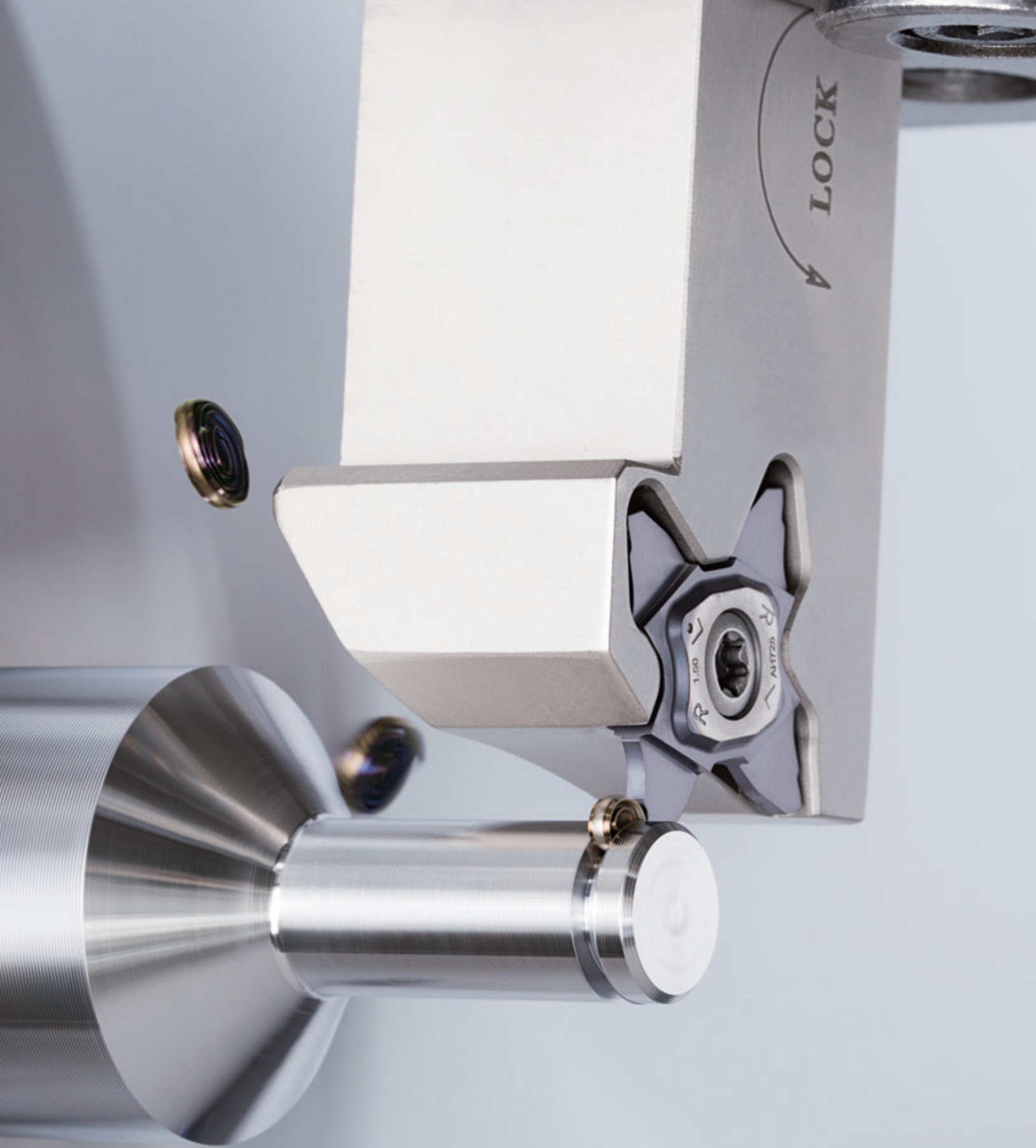

TetraForce-Cut

Tungaloy C003



External Grooving - Quick Guide

Max. groove depth: 0.252"

Series	W (in)	Max. groove depth (in)						See page
		0.040	0.080	0.120	0.160	0.200	0.240	
TetraMini-Cut	0.013	0.031						C055
	0.017 - 0.020	0.047						
	0.030 - 0.069	0.079						
	0.079 - 0.118	0.098						
JTGR/L	0.013	0.028						C018
	0.017 - 0.020	0.043						
	0.026 - 0.037	0.075						
	0.039 - 0.071	0.089						
	0.079 - 0.118	0.102						
GBR/L32	0.013	0.031						C039
	0.020	0.047						
	0.030 - 0.059	0.079						
	0.079 - 0.098	0.098						
GBR/L43	0.049 - 0.057	0.075						C039
	0.059 - 0.091	0.138						
	0.098 - 0.177	0.197						
GX-R/LE	0.039	0.059						C036
	0.059	0.091						
	0.079	0.118						
	0.098	0.150						
	0.118	0.177						
	0.138	0.209						
	0.157 - 0.177	0.236						
TetraForce-Cut	0.020 - 0.030	0.098						C047
	0.031	0.063						
	0.039 - 0.049	0.138						
	0.055	0.079						
	0.058	0.098						
	0.059	0.224						
	0.062 - 0.078	0.118						
	0.079	0.252						
	0.087 - 0.091	0.138						
	0.094 - 0.098	0.224						
0.106 - 0.113	0.244							
0.118 - 0.125	0.252							



- First choice
- Second choice

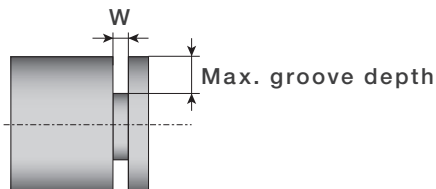

External Grooving - Quick Guide

Max. groove depth: 1.969"

Series	W (in)	Max. groove depth (in)					See page
		0.400	0.800	1.200	1.600	2.000	
MY-T FLEX	0.118	0.394					C118
	0.157	0.472					
	0.197	0.551					
CTD	0.118 - 0.157	0.551					C120
	0.197	20					
MY-T CGD	0.079	0.630					C116
	0.118 - 0.315	0.850					
MY-T G series	0.079	0.630					C092
	0.118	0.866					
	0.157 - 0.197	0.984					
TungCut	0.055	0.630					C059
	0.079	0.699					
	0.118 - 0.157	0.984					
	0.197 - 0.236	0.984	1.260				
EasyMulti-Cut	0.157	0.984	1.181				C125
	0.197	0.984	1.260				
	0.236	0.984	1.378				
TungHeavy Groove	0.394	1.417					C137
	0.591	1.575					
	0.787	1.575					
	0.984	1.969					

- First choice
- Second choice

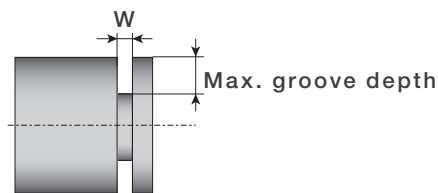

Grooving Tool



External



Internal Grooving - Quick Guide

Series	W (in)	ar (in)	øDm (in)					See page	
			0.400	0.800	1.200	1.600	2.000		
SNG	0.039 - 0.079	0.059	0.315		0.984			C031	
	0.059 - 0.138	0.079	0.551		0.984				
	0.059 - 0.138	0.118		0.787	0.984				
EasyMulti-Cut		0.236		0.787	0.984			C125	
	0.157	0.354			0.984				
		0.433				1.260			
	0.197	0.433				1.575			
	0.236	0.433				1.575			
TungCut		0.236			0.984			C059	
	0.079				0.984				
		0.315			0.984				
	0.118	0.236			0.984				
		0.201			0.984				
		0.315				1.260			
		0.394				1.575			
	0.157	0.236			0.984				
		0.315				1.260			
		0.157				1.220			
		0.394				1.575			
	0.197	0.197				1.220			
0.394					1.575				
0.236	0.157				31				
	0.394				1.575				
0.315	0.197				1.457				
	0.228				1.654				
MY-T G series		0.138			0.984			C092	
	0.118				1.260				
		0.197			1.260				
	0.157	0.197				1.575			
		0.236				1.575			
0.197	0.197			1.260					
	0.236				1.575				
GBR/L32	0.013	0.031			1.260			C040	
	0.020	0.047			1.260				
	0.030-0.098	0.079			1.260				



- First choice
- Second choice

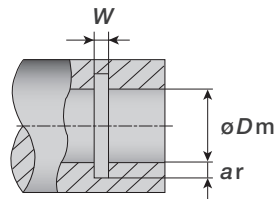

Face Grooving - Quick Guide



Grooving Tool

Series	W (in)	ar (in)	øD (in)							See page	
			2.000	4.000	6.000	8.000	10.000	12.000	16.000		20.000
TungCut	0.118	0.394	1.181	1.969							C059
		0.472	1.811	7.874							
		0.591	1.969	3.937							
	0.157	0.394	1.181 - 1.417								
		0.472	1.181 - 1.575								
		0.630	2.283	9.843							
		0.787	1.417	7.874							
	0.197	0.787	2.362	∞							
		0.984	2.362	7.874							
	0.236	0.787	2.362	9.843							
0.984		2.362	15.748								
MY-T G series	0.118	0.394	1.181	19.685						C092	
		0.551	1.181	19.685							
	0.157	0.551	1.378	19.685							
		0.866	1.378	19.685							
	0.197	0.551	1.378	19.685							
		0.866	1.378	19.685							
EasyMulti-Cut	0.157	1.969	1.181	2.953						C125	
		2.559	2.953	19.685							
	0.197	1.969	1.378	2.953							
		2.559	2.953	19.685							
	0.236	1.969	1.772	2.953							
		2.559	2.953	19.685							
GX-F	0.039	0.059	2.165	∞						C038	
	0.059	0.091	2.165	∞							
	0.079	0.118	2.165	∞							
	0.098	0.150	2.165	∞							
	0.118	0.177	2.165	∞							
	0.138	0.209	2.165	∞							
	0.157 - 0.177	0.236	2.165	∞							

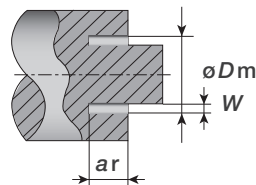

- First choice
- Second choice





Parting off - Quick Guide

Series	W (in)	Max. parting Dia. (in)								See page
		0.400	0.500	1.600	2.400	3.200	4.000	8.000		
TetraForce-Cut	0.020 - 0.030	0.197								C047
	0.031	0.126								
	0.039 - 0.049	0.197								
	0.055	0.157								
	0.058	0.197								
	0.059	0.449								
	0.062 - 0.077	0.236								
	0.079	0.504								
	0.087 - 0.091	0.276								
	0.094 - 0.098	0.448								
	0.106 - 0.113	0.488								
	0.118 - 0.125	0.504								
	DuoJust-Cut	0.039	0.236							
0.059		0.630								
0.079		0.630								
MY-T	0.079			1.696						C092
	0.118			3.937						
	0.157			3.937						
	0.197			4.724						
TungCut	0.055	1.142								C059
	0.079	0.504	1.969							
	0.118	0.504	3.937							
	0.157	1.969	4.724							
	0.197	1.969	4.724							
	0.236	1.969	4.724							
	0.315	3.150								
EasyMulti-Cut	0.157	1.969	3.937							C125
	0.197	1.969	4.724							
	0.236	1.969	4.724							

 First choice
 Second choice

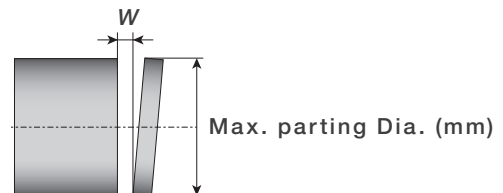



Great cutting performance in **various parting-off operations**

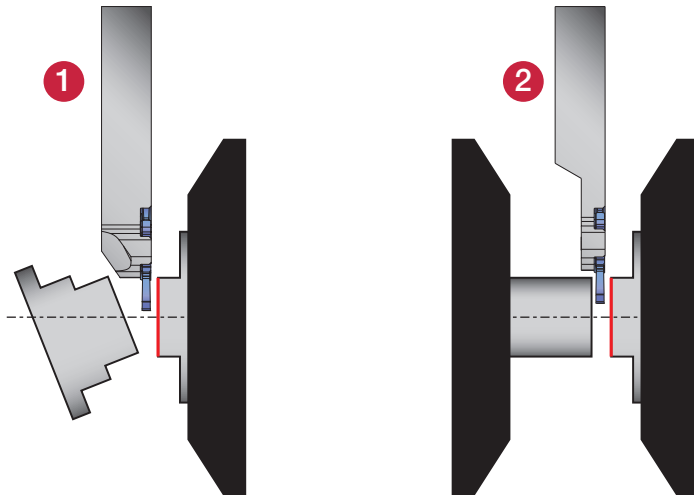

1 JSXXR/L
W = 0.039" - 0.079" (1 - 2 mm)
 Max. parting dia.: 0.630" (16 mm)
 Shank size: 0.375" - 0.50" (10 - 20 mm)
 Page C010

2 JSXXR/L - S
W = 0.039" - 0.079" (1 - 2 mm)
 Max. parting dia.: 0.630" (16 mm)
 Shank size: 0.375" - 0.50" (10 - 12 mm)
 Page C010

3 types of inserts are available for different parting-off diameters can be mounted **in the same pocket of all the toolholders.**

- Optimized overhang length for **stable machining**

Regular-type toolholder



Toolholder for sub-spindle

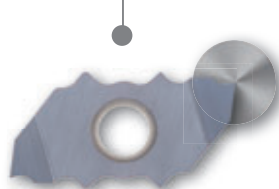

JXPG06
 Max. parting-off dia.
 ø0.236" (ø6 mm)
 Page C011

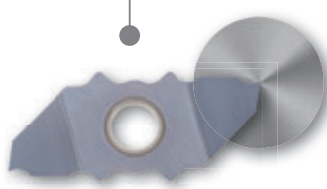

JXPG12
 Max. parting-off dia.
 ø0.472" (ø12 mm)
 Page C011

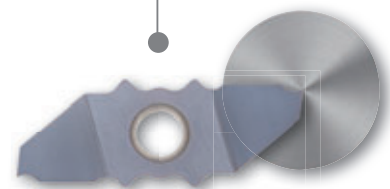

JXPG16
 Max. parting-off dia.
 ø0.630" (ø16 mm)
 Page C011





DUOJ CUT

JSXXR/L

Parting off tool for swiss lathes

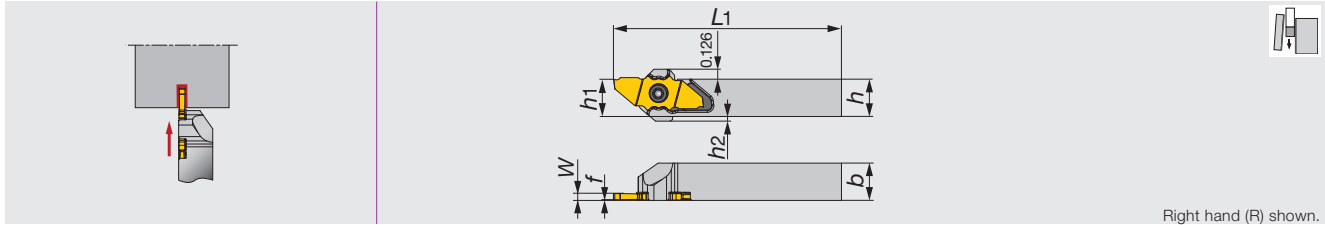

Right hand (R) shown.

Inch	W	h	b	f	L1*	h1	h2	Insert
JSXXR/L063	0.039 - 0.079	0.375	0.375	0.008	≤ 4.75	0.375	0.12	JXPG06...,12...,16...
JSXXR/L083	0.039 - 0.079	0.500	0.500	0.008	≤ 4.75	0.500	0.06	JXPG06...,12...,16...
JSXXR/L103	0.039 - 0.079	0.625	0.625	0.008	≤ 4.75	0.625	0.06	JXPG06...,12...,16...

Metric	W	h	b	f	L1*	h1	h2	Insert
JSXXR/L1010X09	1 - 2	10	10	0.2	≤120	10	3	JXPG06...,12...,16...
JSXXR/L1212F09	1 - 2	12	12	0.2	≤85	12	1.5	JXPG06...,12...,16...
JSXXR/L1212X09	1 - 2	12	12	0.2	≤120	12	1.5	JXPG06...,12...,16...
JSXXR/L1616X09	1 - 2	16	16	0.2	≤120	16	-	JXPG06...,12...,16...
JSXXR/L2020H09	1 - 2	20	20	0.2	≤100	20	-	JXPG06...,12...,16...

* "L1" is calculated with JXPG16*** insert. When JXPG12*** insert is used, "L1" is shorter 0.079" (2 mm).

When JXPG06*** insert is used, "L1" is shorter 0.157" (4 mm).

Note: The right hand insert (JXPG**R***) is used for the right hand toolholders (JSXXR***), and the left hand insert (JXPG**L***) is used for the left hand toolholders (JSXXL***).

SPARE PARTS



Designation	Clamping screw	Wrench
JSXXR...	CSTC-4L100DL	T-1008/5
JSXXL...	CSTC-4L100DR	T-1008/5

DUOJ CUT

JSXXR/L-S

Parting off tool for sub spindle in swiss lathes

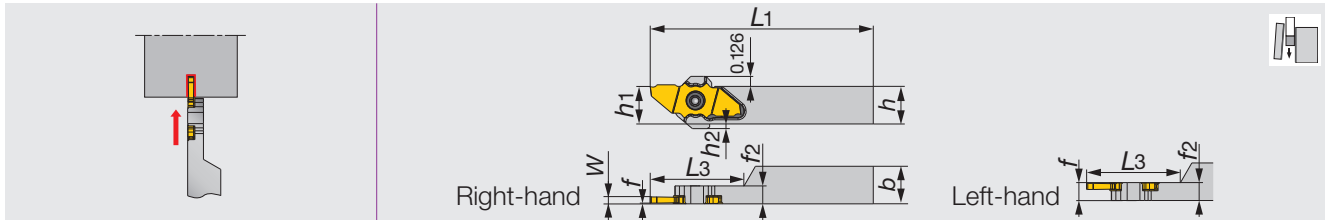

Inch	W	h	b	f	L1*	L3*	h1	h2	f2	Insert
JSXXR/L063-S	0.039 - 0.079	0.375	0.375	0.008 / 0.217	≤ 4.75	≤ 1.03	0.383	0.12	0.226	JXPG06...,12...,16...
JSXXR/L083-S	0.039 - 0.079	0.500	0.500	0.008 / 0.217	≤ 4.75	≤ 1.03	0.500	0.06	0.226	JXPG06...,12...,16...

Metric	W	h	b	f	L1*	L3*	h1	h2	f2	Insert
JSXXR/L1010X09-S	1 - 2	10	10	0.2/5.5	≤120	≤26	10	3	5.7	JXPG06...,12...,16...
JSXXR/L1212F09-S	1 - 2	12	12	0.2/5.5	≤85	≤26	12	1.5	5.7	JXPG06...,12...,16...
JSXXR/L1212X09-S	1 - 2	12	12	0.2/5.5	≤120	≤30	12	1.5	5.7	JXPG06...,12...,16...

* "L1" and "L3" are calculated with JXPG16*** insert. When JXPG12*** insert is used, "L1" and "L3" are 0.079" (2 mm) shorter.

When JXPG06*** insert is used, "L1" and "L3" are 0.157" (4 mm) shorter.

Note: The right-hand insert (JXPG**R***) is used for the right-hand toolholder (JSXXR***), and the left-hand insert (JXPG**L***) is used for the left-hand toolholder (JSXXL***).

SPARE PARTS



Designation	Clamping screw	Wrench
JSXXR**-S	CSTC-4L055DL	T-1008/5
JSXXL**-S	CSTC-4L055DR	T-1008/5

Reference pages

Inserts → C011, Standard cutting conditions → C012

INSERT

JXPG06R/L-F (sharp edge)

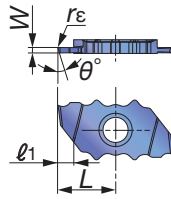

Right hand (R) shown.

Designation	$W_{\pm 0.001}$ (in)	$W_{\pm 0.025}$ (mm)	r_{ϵ} (in)	SH725		D_{max} (in)	L (in)	θ°	ℓ_1 (in)
				R	L				
JXPG06R/L10F	0.039	1	0.002	●	●	0.236	0.413	0	0.104
JXPG06R/L15F	0.059	1.5	0.002	●	●	0.236	0.413	0	0.104
JXPG06R/L10F-15	0.039	1	0.002	●	●	0.236	0.413	15	0.104
JXPG06R/L15F-15	0.059	1.5	0.002	●	●	0.236	0.413	15	0.104

● : Line up
 D_{max} : Max. parting off dia

JXPG12R/L-F (sharp edge)

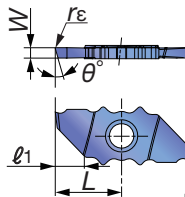

Right hand (R) shown.

Designation	$W_{\pm 0.001}$ (in)	$W_{\pm 0.025}$ (mm)	r_{ϵ} (in)	SH725		D_{max} (in)	L (in)	θ°	ℓ_1 (in)
				R	L				
JXPG12R/L15F	0.059	1.5	0.002	●	●	0.472	0.492	0	0.206
JXPG12R/L20F	0.079	2	0.002	●	●	0.472	0.492	0	0.206
JXPG12R/L15F-15	0.059	1.5	0.002	●	●	0.472	0.492	15	0.206
JXPG12R/L20F-15	0.079	2	0.002	●	●	0.472	0.492	15	0.206

● : Line up
 D_{max} : Max. parting off dia

JXPG16R/L-F (sharp edge)

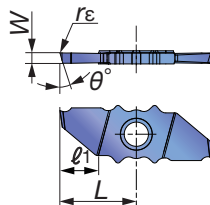

Right hand (R) shown.

Designation	$W_{\pm 0.001}$ (in)	$W_{\pm 0.025}$ (mm)	r_{ϵ} (in)	SH725		D_{max} (in)	L (in)	θ°	ℓ_1 (in)
				R	L				
JXPG16R/L15F	0.059	1.5	0.002	●	●	0.630	0.571	0	0.274
JXPG16R/L20F	0.079	2	0.002	●	●	0.630	0.571	0	0.274
JXPG16R/L15F-15	0.059	1.5	0.002	●	●	0.630	0.571	15	0.274
JXPG16R/L20F-15	0.079	2	0.002	●	●	0.630	0.571	15	0.274

● : Line up
 D_{max} : Max. parting off dia





INSERT

JXTG12FR/L-60 (For Threading / Sharp edge)

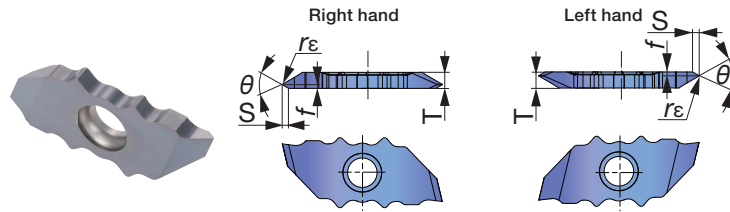

Designation	Grade SH725		Dimensions (in)					
	R	L	Pitch	f	S	r _ε	T	θ (deg)
JXTG12FR/L-60A-000	●	●	0.2 - 0.4	0.01	0.02	0.002 max Flat	0.1	60
JXTG12FR/L-60B-000	●	●	0.2 - 0.4	0.09	0.02	0.002 max Flat	0.1	60
JXTG12FR/L-60A-005	●	●	0.4 - 1	0.02	0.04	0.002	0.1	60
JXTG12FR/L-60B-005	●	●	0.4 - 1	0.08	0.04	0.002	0.1	60
JXTG12FR/L-60N-010	●	●	1 - 1.5	0.05	0.08	0.004	0.1	60

● : Line-up

STANDARD CUTTING CONDITIONS

ISO	Workpiece material	Grade	Cutting speed V _c (sfm)	Feed f (ipr)
P	Low carbon steels 1015, etc.	SH725	164 - 656	0.00039 - 0.0020
	Carbon steels, Alloy steels 1055, etc.	SH725	164 - 656	0.00039 - 0.0020
	Free cutting steels SUH22, SUH23, X50CrSi8 2, etc.	SH725	164 - 656	0.00039 - 0.0020
M	Stainless steels S30400, etc.	SH725	164 - 656	0.00039 - 0.0020
N	Aluminum alloys 5056, 6061, etc.	SH725	490 - 660	0.00039 - 0.0020
	Copper alloy C2600, C280C, etc.	SH725	330 - 660	0.00039 - 0.0020
S	Titanium alloys Ti-6Al-4V, etc.	SH725	98 - 262	0.00039 - 0.0020
	Superalloys Inconel718, etc.	SH725	98 - 262	0.00039 - 0.0020

HOW TO SELECT TOOLS

Application	Large-diameter machining of workpiece with rigidity		Small-diameter machining of workpiece with short overhang	
	Main-spindle tooling	Sub-spindle tooling	Sub-spindle tooling	
			Workpiece with long overhang at the side of sub-spindle for the process after parting-off	Short workpiece with low rigidity
	Position of parting-off is at the side of the main spindle	Position of parting-off is at the side of the sub-spindle	Position of parting-off is at the side of the main spindle	Position of parting-off is at the side of the sub-spindle
Toolholder	R-hand (JSXXR type)	L-hand (JSXXL type)	R-hand (JSXXR-S type)	L-hand (JSXXL-S type)
Insert	Right-hand insert with lead angle to remove center core (JXPG**R***-15 type)	Left-hand insert (JXPG**L*** type)	Right-hand insert (JXPG**R*** type)	Left-hand insert (JXPG**L*** type)

HOW TO SELECT TOOLHOLDERS FOR SUB-SPINDLE

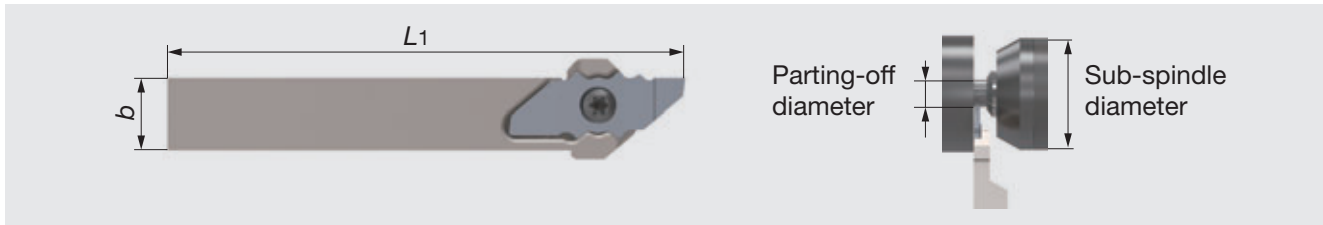

Inch

Sub-spindle dia.	Max parting-off dia.	Shank size b	Tool length L_1	Insert	Toolholder
ø1.574	~ ø0.236	0.375	4.567	JXPG06...	JSXXR/L063-S
ø1.574	~ ø0.236	0.500	3.189	JXPG06...	JSXXR/L083-S
ø1.574	~ ø0.472	0.375	4.646	JXPG12...	JSXXR/L063-S
ø1.574	~ ø0.472	0.500	3.268	JXPG12...	JSXXR/L083-S
ø1.574	~ ø0.630	0.375	4.724	JXPG16...	JSXXR/L063-S
ø1.574	~ ø0.630	0.500	3.346	JXPG16...	JSXXR/L083-S
ø1.969	~ ø0.236	0.500	4.567	JXPG06...	JSXXR/L083-S
ø1.969	~ ø0.472	0.500	4.646	JXPG12...	JSXXR/L083-S
ø1.969	~ ø0.630	0.500	3.346	JXPG16...	JSXXR/L083-S
ø1.969	~ ø0.630	0.500	4.724	JXPG16...	JSXXR/L083-S

MAX. PARTING-OFF DIA. & DEPTH

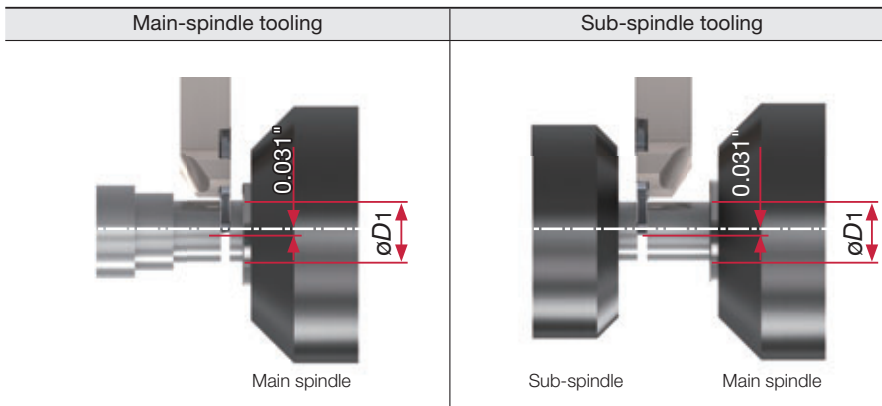

The cutting edge reaches 0.031" beyond the center line in parting-off.
 $\varnothing D_1$ = Max. parting-off dia.



Grooving Tool

DUOJÜT



Parting-off

Others

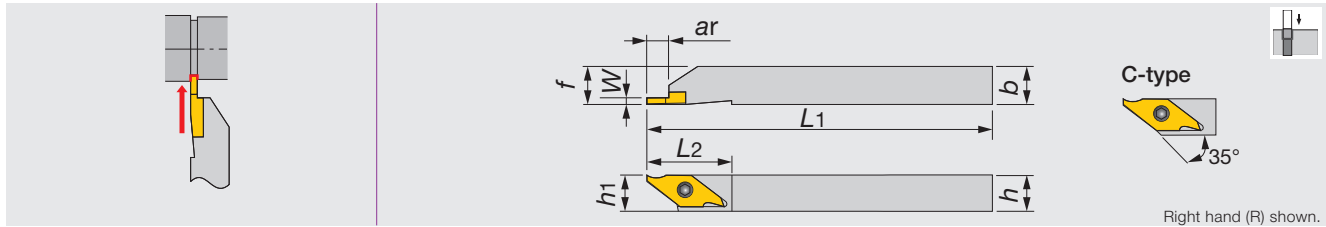

Right hand (R) shown.

Inch	W	ar	h	b	L1	L2	h1	f	Insert
JSVGR/L062.5	0.013 - 0.079	0.028 - 0.217	0.375	0.375	5	0.875	0.375	0.375	JVGR/L...
JSVGR/L082.5	0.013 - 0.079	0.028 - 0.217	0.500	0.500	5	0.875	0.500	0.500	JVGR/L...
JSVGR/L102.5	0.013 - 0.079	0.028 - 0.217	0.625	0.625	5	0.875	0.625	0.625	JVGR/L...

Metric	W	ar	h	b	L1	L2	h1	f	Insert
JSVGR/L1010K-C	0.33 - 2	0.7 - 5.5	10	10	125	23	10	10	JVGR/L...
JSVGR/L1212K-C	0.33 - 2	0.7 - 5.5	12	12	125	23	12	12	JVGR/L...
JSVGR/L1616K	0.33 - 2	0.7 - 5.5	16	16	125	23	16	16	JVGR/L...

• Recommend clamping torque: 2.3 N·m.

SPARE PARTS



Designation	Clamping screw	Wrench
JSVGR/L...	CSTB-3S	T-9F(Optional T-9L)

APPLICABLE INSERT

JVG-type (sharp edge)

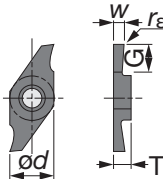

Right hand (R) shown.

Designation	W ^{+0.002} (in)	W ^{+0.05} (mm)	r _ε (in)	Coated		Cermet		Uncoated		ød (mm)	T (mm)	G (mm)
				J740	SH725	NS9530	TH10					
JVGR/L033F	0.013	0.33	0	●	● ●		●	7.94	3.18	0.7		
JVGR/L050F	0.020	0.5	0	●	● ●		●	7.94	3.18	1.1		
JVGR/L075F	0.030	0.75	0	●	● ●		●	7.94	3.18	1.9		
JVGR/L095F	0.037	0.95	0	●	● ●		●	7.94	3.18	1.9		
JVGR/L100F	0.039	1	0	●	● ●	● ●	● ●	7.94	3.18	5.5		
JVGR/L125F	0.049	1.25	0	●	● ●		●	7.94	3.18	5		
JVGR/L150F	0.059	1.5	0	●	● ●	● ●	● ●	7.94	3.18	5.5		
JVGR/L200F	0.079	2	0	●	● ●	●	●	7.94	3.18	5.5		

● : Line up

Reference pages

Standard cutting conditions → C020

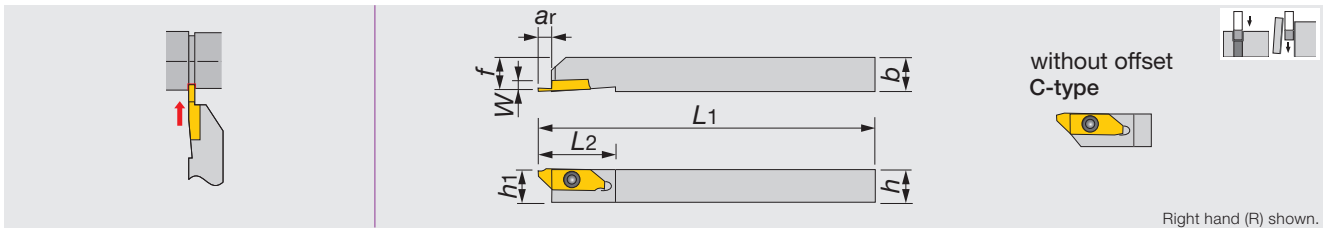

Metric	W	ar	h	b	L1	L2	h1	f	Insert
JSXGR/L1010K8-C	0.7 - 2	4.5 - 6	10	10	125	29	10	9.9	JXG...
JSXGR/L1212K8-C	0.7 - 2	4.5 - 6	12	12	125	29	12	11.9	JXG...
JSXGR/L1616K8	0.7 - 2	4.5 - 6	16	16	125	29	16	15.9	JXG...
JSXGR/L2020K8	0.7 - 2	4.5 - 6	20	20	125	29	20	19.9	JXG...
JSXGR/L2525K8	0.7 - 2	4.5 - 6	25	25	125	29	25	24.9	JXG...

• Can be wrenched from back side with double socket torx screw. • JSXGR/L-type toolholders are used for JXG-type grooving inserts, JXF-type front-turning inserts and JXR-type reverse-turning inserts.

SPARE PARTS



Designation	Clamping screw	Wrench
JSXGR/L...	CSTB-4SD	T-8F

APPLICABLE INSERT

JXG-type (with hand and sharp edge)

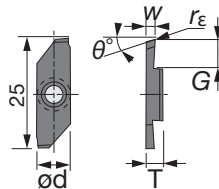

Right hand (R) shown.

Designation	W±0.025 (mm)	rε (mm)	Coated		Uncoated		ød (mm)	T (mm)	θ°	G (mm)
			J740		TH10					
			R	L	R	L				
JXGR/L8070FA	0.7	0	●	●	●	●	8	3.97	15	4.5
JXGR/L8070FA-005	0.7	0.05	●				8	3.97	15	4.5
JXGR/L8100FA	1	0	●	●	●	●	8	3.97	15	6
JXGR/L8100FA-005	1	0.05	●				8	3.97	15	6
JXGR/L8100FA45	1	0	●		●		8	3.97	15	4.5
JXGR/L8100FA45-005	1	0.05	●				8	3.97	15	4.5
JXGR/L8150FA	1.5	0	●	●	●	●	8	3.97	15	6
JXGR/L8150FA-005	1.5	0.05	●				8	3.97	15	6
JXGR/L8150FA50	1.5	0	●		●		8	3.97	15	5
JXGR/L8150FA50-005	1.5	0.05	●				8	3.97	15	5
JXGR/L8180FA	1.8	0	●		●		8	3.97	15	6
JXGR/L8180FA-005	1.8	0.05	●				8	3.97	15	6
JXGR/L8200FA	2	0	●	●	●	●	8	3.97	15	6
JXGR/L8200FA-005	2	0.05	●				8	3.97	15	6
JXGR/L8200FN	2	0	●	●	●	●	8	3.97	0	6
JXGR/L8200FN-005	2	0.05	●				8	3.97	0	6

● : Line up

Reference pages

Standard cutting conditions → C020



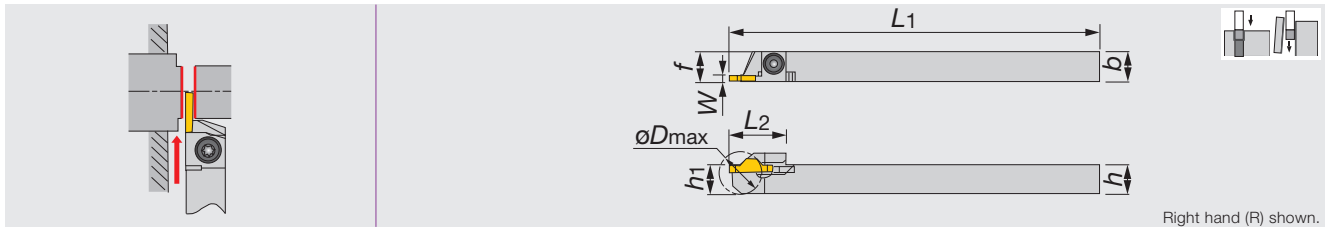

Inch	W	øDmax	h	b	L1	L2	h1	f	Insert
JCCWSR/L062	0.079	0.787	0.375	0.375	5	0.748	0.375	0.1875	JCC*200...
JCCWSR/L082	0.079	0.787	0.500	0.500	5	0.748	0.500	0.250	JCC*200...
JCCWSR/L102	0.079	0.787	0.625	0.625	5	0.748	0.625	0.3125	JCC*200...

Metric	W	øDmax	h	b	L1	L2	h1	f	Insert
JCCWSR/L1010K2	2	20	10	10	125	19	10	10	JCC*200...
JCCWSR/L1212K2	2	20	12	12	125	19	12	12	JCC*200...
JCCWSR/L1616K2	2	20	16	16	125	19	16	16	JCC*200...
JCCWSR/L2020K2	2	20	20	20	125	19	20	20	JCC*200...
JCCWSR/L2525K2	2	20	25	25	125	19	25	25	JCC*200...

øDmax: Max. parting off dia.

SPARE PARTS

Designation	Clamping screw	Wrench
JCCWSR/L...	CSTB-4S	T-15F

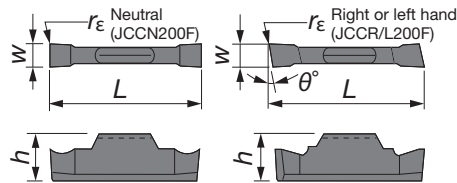
APPLICABLE INSERT**JCC-type (sharp edge)**

Right hand (R) shown.

Designation	W±0.001 (in)	W±0.025 (mm)	rε (mm)	Coated		Uncoated		h (mm)	L (mm)	θ°
				J740		TH10				
				R	L	R	L			
JCCN200F	0.079	2	0	●		●		4.8	15	0
JCCN200F-005	0.079	2	0.05	●				4.8	15	0
JCCR/L200F	0.079	2	0	●	●	●	●	4.8	15	15
JCCR/L200F-005	0.079	2	0.05	●	●			4.8	15	15

● : Line up



External



Parting-off

Reference pages

Standard cutting conditions → **C020**

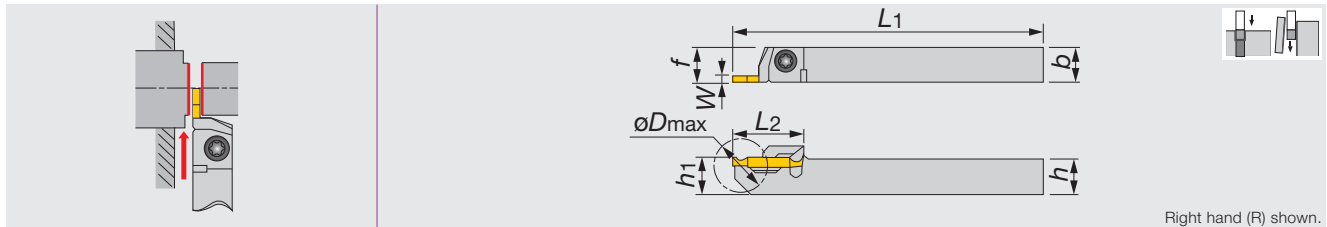

Right hand (R) shown.

Metric	W	øDmax	h	b	L1	L2	h1	f	Insert
JCGWSR/L1010K2	2	20	10	10	125	20	10	10	JCGN200F...
JCGWSR/L1212K2	2	20	12	12	125	20	12	12	JCGN200F...
JCGWSR/L1616K2	2	20	16	16	125	20	16	16	JCGN200F...

øDmax: Max. parting off dia.

SPARE PARTS



Designation	Clamping screw	Wrench
JCGWSR/L...	CSTB-4S	T-15F

APPLICABLE INSERT

JCG-type (sharp edge)

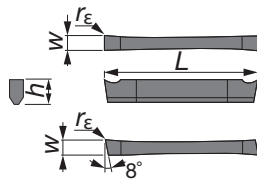

Right hand (R) shown.

Designation	W±0.025 (mm)	rε (mm)	Coated		Uncoated		h (mm)	L (mm)
			J740		TH10			
			R	L	R	L		
JCGN200F	2	0.05		●		●	3	20
JCGN200FR/L	2	0.05	●	●	●	●	3	20

● : Line up



Reference pages

Standard cutting conditions → C020



J-SERIES

JSTGR/L

External grooving toolholders for swiss lathes

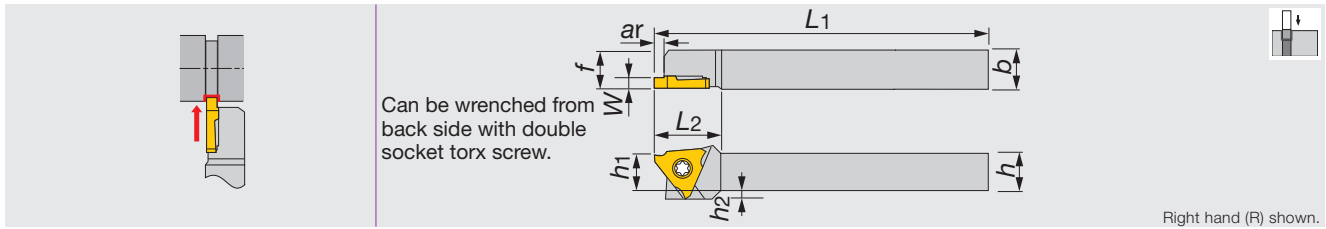

Inch	W	ar	h	b	L1	L2	h1	f	h2	Insert
JSTGR/L063	0.013 - 0.118	0.028 - 0.102	0.375	0.375	5	0.75	0.375	0.375	0.100	JTGR/L3...
JSTGR/L083	0.013 - 0.118	0.028 - 0.102	0.500	0.500	5	0.75	0.500	0.500	-	JTGR/L3...
JSTGR/L103	0.013 - 0.118	0.028 - 0.102	0.625	0.625	5	0.75	0.625	0.625	-	JTGR/L3...

Metric	W	ar	h	b	L1	L2	h1	f	h2	Insert
JSTGR/L1010X3	0.33 - 3	0.7 - 2.6	10	10	120	18.5	10	10	2	JTGR/L3...
JSTGR/L1212F3	0.33 - 3	0.7 - 2.6	12	12	85	18.5	12	12	-	JTGR/L3...
JSTGR/L1212X3	0.33 - 3	0.7 - 2.6	12	12	120	18.5	12	12	-	JTGR/L3...
JSTGR/L1616X3	0.33 - 3	0.7 - 2.6	16	16	120	18.5	16	16	-	JTGR/L3...
JSTGL1616K3	0.33 - 3	0.7 - 2.6	16	16	125	18.5	16	16	-	JTGR/L3...

• Recommend clamping torque: 1.2 N·m.

SPARE PARTS

Designation	Clamping screw	Wrench
JSTGR/L...	CSTB-4SD	T-8F

J-SERIES

JS-TGL3

External grooving toolholders for swiss lathe, perpendicularly mounted inserts

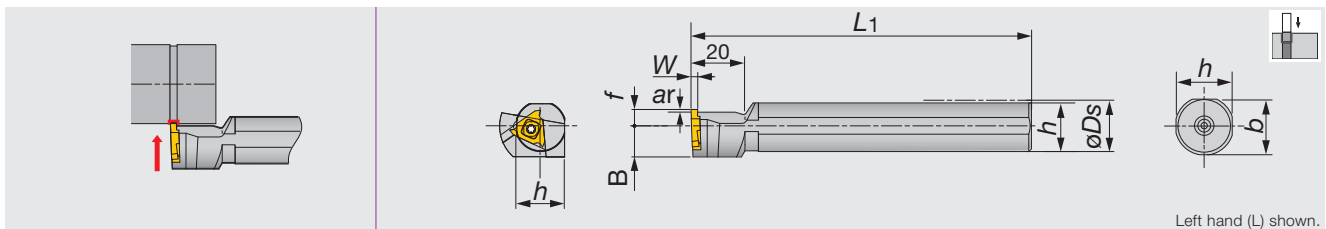

Metric	W (mm)	W (in)	ar	øDs	f	L1	h	b	B	Insert
JS19K-TGL3	0.33 - 3	0.013 - 0.118	0.7 - 2.6	19.05 (0.75")	6	125	18	18	11.5	JTGR3...
JS20K-TGL3	0.33 - 3	0.013 - 0.118	0.7 - 2.6	20	6	125	19	19	11.5	JTGR3...
JS22K-TGL3	0.33 - 3	0.013 - 0.118	0.7 - 2.6	22	6	125	21	21	11.5	JTGR3...
JS25K-TGL3	0.33 - 3	0.013 - 0.118	0.7 - 2.6	25.4 (1.00")	10	125	24	24	12.7	JTGR3...

• Left hand toolholders (TGL3) are used with right hand inserts (JTGR3). • Recommend clamping torque: 3.0 Nm·ft.

SPARE PARTS

Designation	Clamping screw	Wrench
JS***-TGL3	CSTB-4S	T-15F

Reference pages

Inserts → C019 - C020, Standard cutting conditions → C020

APPLICABLE INSERT

JTG-type (sharp edge)

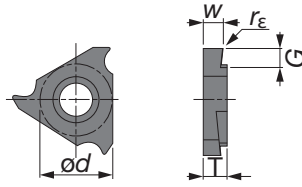

Right hand (R) shown.

Designation	$W_{0.05}^{+0.05}$ (mm)	$W_{0.002}^{+0.002}$ (in)	r_{ϵ} (mm)	Coated				Cermet		Uncoated		ϕd (mm)	T (mm)	G (mm)
				SH725		J740		NS9530		TH10				
				R	L	R	L	R	L	R	L			
JTGR/L3033F	0.33	0.013	0.03	●		●	●			●	●	9.525	3.18	0.7
JTGR/L3033F-005	0.33	0.013	0.05	●								9.525	3.18	0.7
JTGR/L3043F	0.43	0.017	0.03			●						9.525	3.18	1.1
JTGR/L3050F	0.5	0.020	0.03	●	●	●	●	●		●	●	9.525	3.18	1.1
JTGR/L3050F-005	0.5	0.020	0.05	●	●							9.525	3.18	1.1
JTGR/L3065F	0.65	0.026	0.03	●		●						9.525	3.18	1.9
JTGR/L3065F-010	0.65	0.026	0.1	●								9.525	3.18	1.9
JTGR/L3075F	0.75	0.030	0.03	●	●	●	●	●	●	●	●	9.525	3.18	1.9
JTGR/L3075F-010	0.75	0.030	0.1	●	●							9.525	3.18	1.9
JTGR/L3080F	0.8	0.031	0.03	●		●						9.525	3.18	1.9
JTGR/L3080F-010	0.8	0.031	0.1	●								9.525	3.18	1.9
JTGR/L3085F	0.85	0.034	0.03	●		●						9.525	3.18	1.9
JTGR/L3095F	0.95	0.037	0.03	●	●	●	●	●		●	●	9.525	3.18	1.9
JTGR/L3095F-010	0.95	0.037	0.1	●	●							9.525	3.18	1.9
JTGR/L3100F	1	0.039	0.05	●	●	●	●	●		●	●	9.525	3.18	2.1
JTGR/L3100F-010	1	0.039	0.1	●	●							9.525	3.18	2.1
JTGR/L3110F	1.1	0.043	0.05	●		●						9.525	3.18	2.1
JTGR/L3120F	1.2	0.047	0.05	●		●						9.525	3.18	2.1
JTGR/L3120F-010	1.2	0.047	0.1	●								9.525	3.18	2.1
JTGR/L3125F	1.25	0.049	0.05	●	●	●	●	●		●	●	9.525	3.18	2.1
JTGR/L3125F-010	1.25	0.049	0.1	●	●							9.525	3.18	2.1
JTGR/L3130F	1.3	0.051	0.05	●		●						9.525	3.18	2.1
JTGR/L3140F	1.4	0.055	0.05	●		●						9.525	3.18	2.1
JTGR/L3140F-010	1.4	0.055	0.1	●								9.525	3.18	2.1
JTGR/L3145F	1.45	0.057	0.05	●		●	●	●		●	●	9.525	3.18	2.1
JTGR/L3145F-010	1.45	0.057	0.1	●								9.525	3.18	2.1
JTGR/L3150F	1.5	0.059	0.05	●	●	●	●	●		●	●	9.525	3.18	2.1
JTGR/L3150F-010	1.5	0.059	0.1	●	●							9.525	3.18	2.1
JTGR/L3175F	1.75	0.069	0.05	●		●	●	●	●	●	●	9.525	3.18	2.1
JTGR/L3175F-010	1.75	0.069	0.1	●								9.525	3.18	2.1
JTGR/L3180F	1.8	0.071	0.05	●		●						9.525	3.18	2.1
JTGR/L3200F	2	0.079	0.05	●	●	●	●	●		●	●	9.525	3.18	2.6
JTGR/L3200F-010	2	0.079	0.1	●	●							9.525	3.18	2.6
JTGR/L3225F	2.25	0.089	0.05	●		●						9.525	3.18	2.6
JTGR/L3250F	2.5	0.098	0.05	●	●	●	●	●		●	●	9.525	3.18	2.6
JTGR/L3250F-010	2.5	0.098	0.1	●	●							9.525	3.18	2.6
JTGR/L3275F	2.75	0.108	0.05			●						9.525	3.18	2.6
JTGR/L3300F	3	0.118	0.05	●		●						9.525	3.18	2.6
JTGR/L3300F-010	3	0.118	0.1	●								9.525	3.18	2.6

● : Line up



APPLICABLE INSERT

JTG-type (with honed edge)

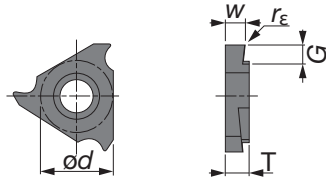

Right hand (R) shown.

Designation	$W_{\pm 0.05}^{\pm 0.05}$ (mm)	$W_{\pm 0.002}^{\pm 0.002}$ (in)	r_{ϵ} (mm)	J9530		ϕd (mm)	T (mm)	G (mm)
				R	L			
JTGR/L3100	1	0.039	0.05	●		9.525	3.18	2.1
JTGR/L3125	1.25	0.049	0.05	●		9.525	3.18	2.1
JTGR/L3150	1.5	0.059	0.05	●		9.525	3.18	2.1
JTGR/L3200	2	0.079	0.05	●		9.525	3.18	2.6

● : Line up

STANDARD CUTTING CONDITIONS FOR J SERIES GROOVING TOOLS

ISO	Workpiece material	Grade	Cutting speed V_c (sfm)	Feed f (ipr)
P	General steels, Free-cutting steels, etc.	J740	30 - 330	0.001 - 0.004
		SH725	160 - 500	0.001 - 0.004
		NS9530	160 - 500	0.001 - 0.004
		J9530	160 - 500	0.001 - 0.004
M	Stainless steels, etc.	J740	30 - 330	0.001 - 0.004
		SH725	50 - 150	0.001 - 0.004
N	Aluminum alloys, copper alloys, etc.	TH10	300 - 650	0.001 - 0.004
S	Difficult-to-cut materials, titanium alloys, etc.	TH10	30 - 100	0.001 - 0.004

TUNGST-CLAMP

FLASR/L

External grooving & threading toolholders for swiss lathes



Grooving Tool

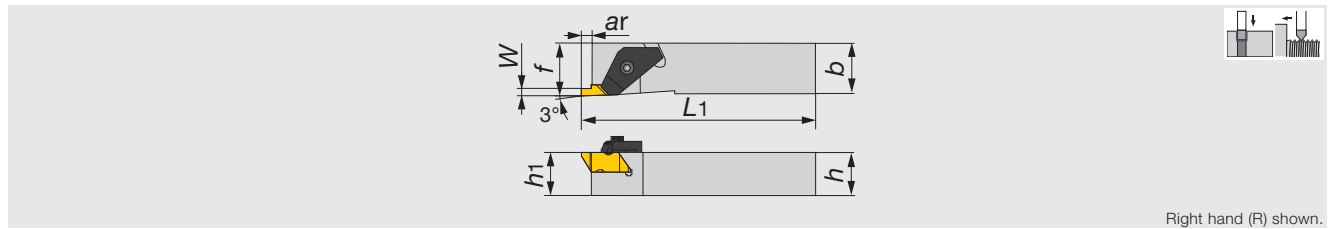

Right hand (R) shown.

Inch	W	ar	h1	h	b	L1	f	Insert
FLASR/L-082D	0.031 - 0.128	0.138	0.500	0.500	0.500	6.000	0.500	FL*-2**R/L...
FLASR-102B	0.031 - 0.128	0.138	0.625	0.625	0.625	4.500	0.625	FL*-2**R...
FLASR/L-103B	0.031 - 0.250	0.210	0.625	0.625	0.625	4.500	0.625	FL*-3**R/L...

Metric	W	ar	h1	h	b	L1	f	Insert
FLASR/L-1212M2	0.79 - 3.25	3.51	12	12	12	150	12	FL*-2**R/L...
FLASR-1616M2	0.79 - 3.25	3.51	16	16	16	150	16	FL*-2**R...
FLASR/L-1616M3	0.79 - 6.35	5.31	16	16	16	125	16	FL*-3**R/L...

Note: The right hand toolholders use right hand inserts, and the left hand toolholders use left hand inserts.

Inch SPARE PARTS



Designation	Clamp	Clamping screw	Wrench
FLASR-082D	TF-182	S-310	5/32HEX
FLASL-082D	TF-183	S-310	5/32HEX
FLASR-102B, FLASR-103B	TF-184	S-412	5/32HEX
FLASL-103B	TF-185	S-412	5/32HEX

Metric SPARE PARTS



Designation	Clamp	Clamping screw	Wrench
FLASR-1212M2	TF-182	S-310	5/32HEX
FLASL-1212M2	TF-183	S-310	5/32HEX
FLASR-1616M2, FLASR-1616M3	TF-184	S-412	5/32HEX
FLASL-1616M3	TF-185	S-412	5/32HEX

TUNGST-CLAMP

FLSR/L

External toolholders for grooving & threading



External

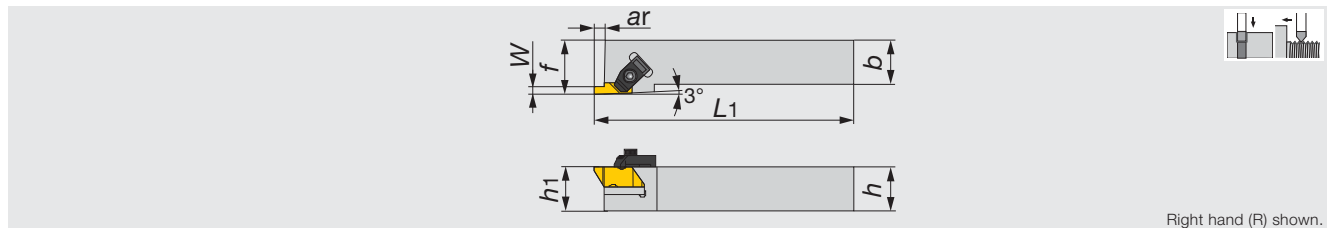

Right hand (R) shown.

Inch	W	ar	h1	h	b	L1	f	Insert
FLSR/L-122B	0.031 - 0.128	0.140	0.750	0.750	0.750	4.500	1.000	FL*-2**R/L...
FLSR/L-162C	0.031 - 0.128	0.140	1.000	1.000	1.000	5.000	1.250	FL*-2**R/L...
FLSR/L-123B	0.031 - 0.250	0.210	0.750	0.750	0.750	4.500	1.000	FL*-3**R/L...
FLSR/L-163C	0.031 - 0.250	0.210	1.000	1.000	1.000	5.000	1.250	FL*-3**R/L...

Metric	W	ar	h1	h	b	L1	f	Insert
FLSR/L-2020M3	0.79 - 6.35	4.5	20	20	20	125	32	FL*-3**R/L...
FLSR/L-2525M3	0.79 - 6.35	4.5	25	25	25	150	32	FL*-3**R/L...

Note: The right hand toolholders use right hand inserts, and the left hand toolholders use left hand inserts.

Inch SPARE PARTS



Designation	Clamp	Clamping screw	Wrench
FLSR-122B, FLSR-162C	TF-74	S-310	5/32HEX
FLSL-122B, FLSL-162C	TF-75	S-310	5/32HEX
FLSR-123B, FLSR-163C	TF-72	S-412	5/32HEX
FLSL-123B, FLSL-163C	TF-73	S-412	5/32HEX

Metric SPARE PARTS



Designation	Clamp	Clamping screw	Wrench
FLSR-***M3	TF-72	S-412	5/32HEX
FLSL-***M3	TF-73	S-412	5/32HEX

Reference pages

Inserts → C026 - C029

Others



TUNGST-CLAMP

FLER/L

External toolholders for grooving & threading

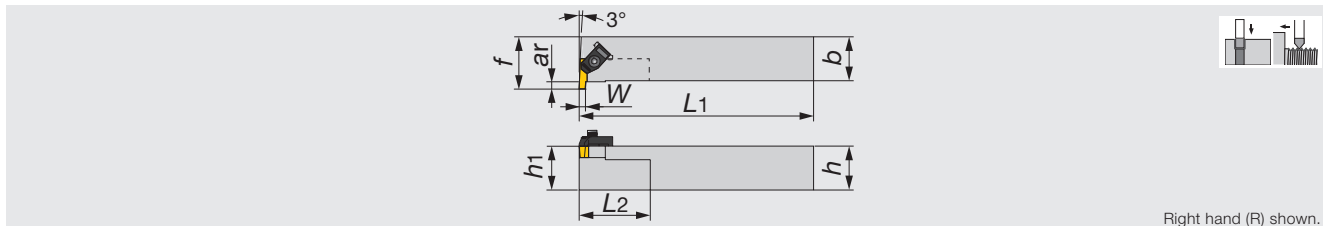

Right hand (R) shown.

Inch	W	ar	h1	h	b	L1	L2	f	Insert
FLER/L-122B	0.031 - 0.128	0.140	0.750	0.750	0.750	4.500	1.000	1.000	FL*-2**/R...
FLER/L-162C	0.031 - 0.128	0.140	1.000	1.000	1.000	5.000	1.000	1.250	FL*-2**/R...
FLER/L-123B	0.031 - 0.250	0.210	0.750	0.750	0.750	4.500	2.000	1.125	FL*-3**/R...
FLER/L-163D	0.031 - 0.250	0.210	1.000	1.000	1.000	6.000	2.000	1.250	FL*-3**/R...

Note: The right hand toolholders use right hand inserts, and the left hand toolholders use left hand inserts.

SPARE PARTS



Designation	Clamp	Clamping screw	Wrench
FLER-122B, FLER-162C	TF-75	S-310	7/64HEX
FLER-123B, FLER-163D	TF-73	S-412	5/32HEX
FLER-122B, FLEL-162C	TF-74	S-310	7/64HEX
FLEL-123B, FLEL-163D	TF-72	S-412	5/32HEX



TUNGST-CLAMP

FLSR/LT

External toolholders for grooving & threading

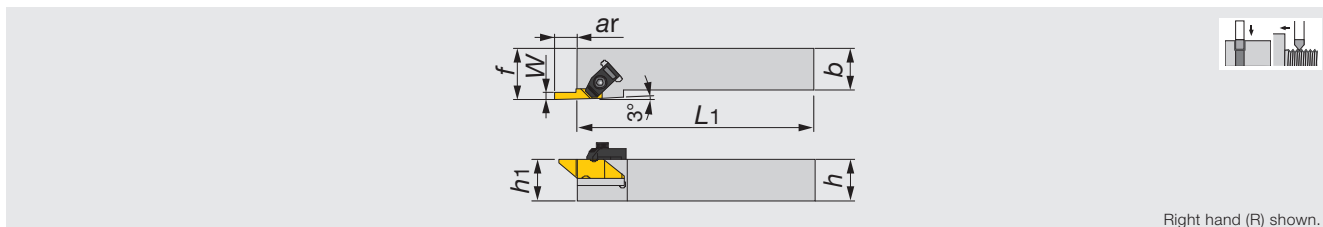

Right hand (R) shown.

Inch	W	ar	h1	h	b	L1	f	Insert
FLSR/LT-163D	0.094 - 0.189	0.440	1.000	1.000	1.000	6.000	1.250	FLGT-3R/L...
FLSR/LT-203D	0.094 - 0.189	0.440	1.250	1.250	1.250	6.000	1.500	FLGT-3R/L...

Note: The right hand toolholders use right hand inserts, and the left hand toolholders use left hand inserts.

SPARE PARTS



Designation	Clamp	Clamping screw	Wrench
FLSRT-163D, FLSRT-203D	TF-72	S-412	5/32HEX
FLSLT-163D, FLSLT-203D	TF-73	S-412	5/32HEX

Reference pages

Inserts → C026 - C029

TUNGST-CLAMP

FLER/LT

External toolholders for grooving & threading

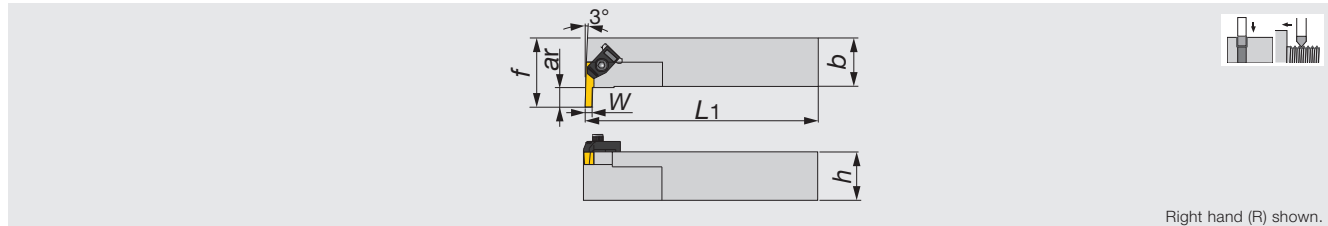

Right hand (R) shown.

Inch	W	ar	h1	h	b	L1	f	Insert
FLER/LT-163D	0.094 - 0.189	0.440	1.000	1.000	1.000	6.000	1.250	FLGT-3R/L...
FLER/LT-203D	0.094 - 0.189	0.440	1.250	1.250	1.250	6.000	1.500	FLGT-3R/L...

Note: The right hand toolholders use right hand inserts, and the left hand toolholders use left hand inserts.

SPARE PARTS



Designation	Clamp	Clamping screw	Wrench
FLERT-163D, FLERT-203D	TF-72	S-412	5/32HEX
FLELT-163D, FLELT-203D	TF-73	S-412	5/32HEX

Grooving Tool

TUNGST-CLAMP

TUNGST-CLAMP

A-FLER/LT

Internal toolholders for grooving & threading

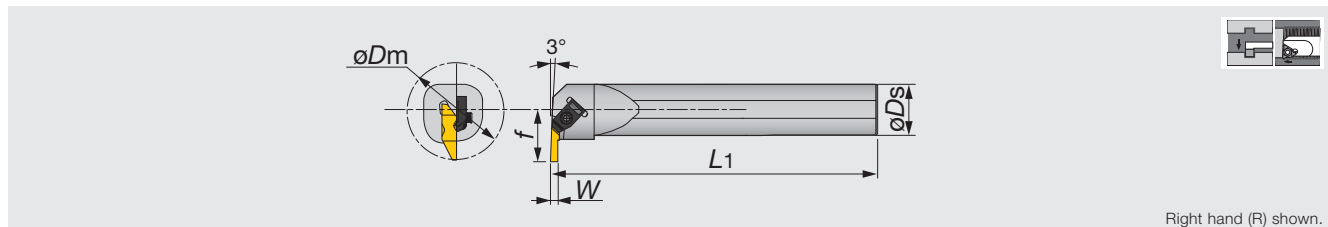

Right hand (R) shown.

Inch	W	øDm	øDs	L1	f	Insert
A20-FLER/LT3	0.094 - 0.189	1.807	1.250	6.000	1.082	FLGT-3R/L...
A24-FLER/LT3	0.094 - 0.189	2.057	1.500	6.000	1.207	FLGT-3R/L...

Note: The right hand toolholders use right hand inserts, and the left hand toolholders use left hand inserts.

SPARE PARTS



Designation	Clamp	Clamping screw	Wrench
A20-FLERT3, A24-FLERT3	TF-72	S-412	5/32HEX
A20-FLELT3, A24-FLELT3	TF-73	S-412	5/32HEX

External

Internal

Others

Reference pages

Inserts → C026 - C029



TUNGST-CLAMP

A_M-FLER/L

Internal toolholders for grooving & threading

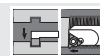
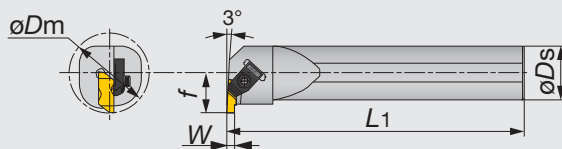

Right hand (R) shown.

Inch	W	ϕD_m	ϕD_s	L1	f	Insert
A08-FLER/L2	0.031 - 0.125	0.730	0.500	8.000	0.437	FL*-2**L/R...
A10-FLER2	0.031 - 0.125	1.000	0.625	10.000	0.500	FL*-2**L...
A12-FLER/L2	0.031 - 0.128	1.125	0.750	10.000	0.562	FL*-2**L/R...
A16-FLER/L2	0.031 - 0.128	1.375	1.000	12.000	0.688	FL*-2**L/R...
A16-FLER/L3	0.031 - 0.250	1.375	1.000	12.000	0.688	FL*-3**L/R...

Metric	W	ϕD_m	ϕD_s	L1	f	Insert
A25M-FLER/L3	0.79 - 6.35	34.9	25	300	17.7	FL*-3**L/R...
A32M-FLER/L3	0.79 - 6.35	44.45	32	350	22.1	FL*-3**L/R...
A40M-FLER3	0.79 - 6.35	50.8	40	350	24.5	FL*-3**L...

Note: The right hand boring bars used for the left hand inserts, and the left hand boring bars used for the right hand inserts.

Inch

SPARE PARTS



Designation	Clamp	Clamping screw	Wrench
A08-FLER2	TF-146	S-310	5/32HEX
A08-FLEL2	TF-147	S-310	5/32HEX
A10-FLER2, A12-FLER2, A16-FLER2	TF-75	S-310	5/32HEX
A12-FLEL2, A16-FLEL2	TF-74	S-310	5/32HEX
A16-FLER3	TF-73	S-412	5/32HEX
A16-FLEL3	TF-72	S-412	5/32HEX

Metric

SPARE PARTS



Designation	Clamp	Clamping screw	Wrench
A**M-FLER3	TF-73	S-412	5/32HEX
A**M-FLEL3	TF-72	S-412	5/32HEX



TUNGST-CLAMP

HS-FLER/L

Exchangeable heads for internal grooving & threading, applicable on S-570 shanks

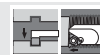
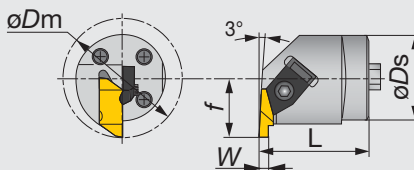

Right hand (R) shown.

Metric	W	ϕD_m	ϕD_s	L	f	Insert
HS40-FLER3W	0.79 - 6.35	56.1	40	40.1	28	FL*-3**L...
HS50-FLER3W	0.79 - 6.35	70.1	50	41.9	35	FL*-3**L...

SPARE PARTS



Designation	Clamp	Clamping screw	Wrench
HS40-FLER3W	TF-73	S-412	5/32HEX
HS50-FLER3W	TF-73	S-412	5/32HEX

Reference pages

Inserts → C026 - C029

TUNGT-CLAMP

S-570

Steel shanks for exchangeable head



Grooving Tool

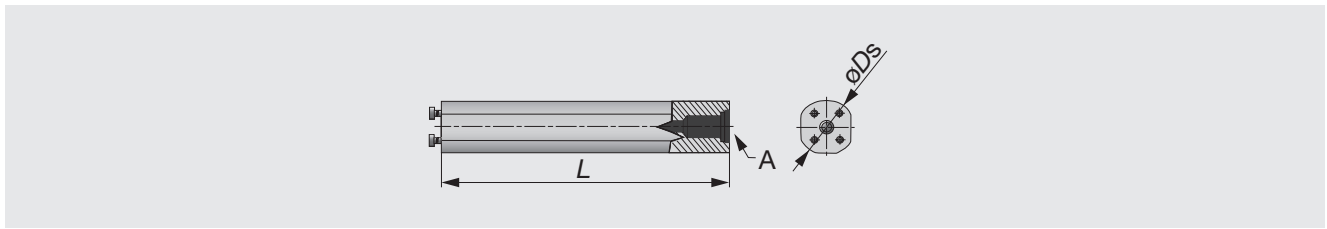

Metric	$\varnothing D_s$	L	A
S-570-40M-40	40	273	1/2-14NPT
S-570-50M-50	50	366	1/2-14NPT

SPARE PARTS



Designation	Clamping screw	Wrench
S-570-40M-40	SS100	5/32HEX
S-570-50M-50	SS94	1/4HEX

TUNGT-CLAMP



Internal

Others

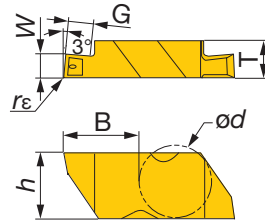
**INSERT****FLG-CB (With chipbreaker, metric width)**

Designation	$W \pm 0.025$		$r\epsilon$ (in)	AH110		G (in)	ϕd (in)	T (in)	h (in)	B (in)
	(mm)	(in)		R	L					
FLG-3M100R/L-CB	1	0.039	0.005 - 0.010	●	●	0.075	0.3750	0.195	0.344	0.4050
FLG-3M150R/L-CB	1.5	0.059	0.005 - 0.010	●	●	0.120	0.3750	0.195	0.344	0.4050
FLG-3M200R/L-CB	2	0.079	0.005 - 0.010	●	●	0.120	0.3750	0.195	0.344	0.4050
FLG-3M250R/L-CB	2.5	0.098	0.005 - 0.010	●	●	0.180	0.3750	0.195	0.344	0.4050
FLG-3M300R/L-CB	3	0.118	0.005 - 0.010	●	●	0.180	0.3750	0.195	0.344	0.4050

● : Line up

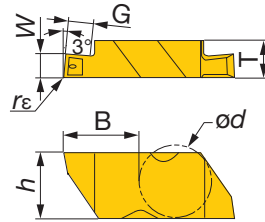
FLG-CB (With chipbreaker)

Designation	$W \pm 0.025$		$r\epsilon$ (in)	AH110		G (in)	ϕd (in)	T (in)	h (in)	B (in)
	(mm)	(in)		R	L					
FLG-2047R/L-CB	1.20	0.047	0.002 - 0.005	●	●	0.050	0.1875	0.150	0.219	0.2700
FLG-2062R/L-CB	1.57	0.062	0.005 - 0.010	●	●	0.110	0.1875	0.150	0.219	0.2700
FLG-2078R/L-CB	1.98	0.078	0.005 - 0.010	●	●	0.110	0.1875	0.150	0.219	0.2700
FLG-2094R/L-CB	2.39	0.094	0.005 - 0.010	●	●	0.110	0.1875	0.150	0.219	0.2700
FLG-2125R/L-CB	3.18	0.125	0.005 - 0.010	●	●	0.110	0.1875	0.150	0.219	0.2700
FLG-3031R/L-CB	0.79	0.031	0.002 - 0.005	●	●	0.050	0.3750	0.195	0.344	0.4050
FLG-3047R/L-CB	1.19	0.047	0.005 - 0.010	●	●	0.075	0.3750	0.195	0.344	0.4050
FLG-3062R/L-CB	1.57	0.062	0.005 - 0.010	●	●	0.120	0.3750	0.195	0.344	0.4050
FLG-3072R/L-CB	1.83	0.072	0.005 - 0.010	●	●	0.120	0.3750	0.195	0.344	0.4050
FLG-3078R/L-CB	1.98	0.078	0.005 - 0.010	●	●	0.120	0.3750	0.195	0.344	0.4050
FLG-3088R/L-CB	2.24	0.088	0.005 - 0.010	●	●	0.180	0.3750	0.195	0.344	0.4050
FLG-3094R/L-CB	2.39	0.094	0.005 - 0.010	●	●	0.180	0.3750	0.195	0.344	0.4050
FLG-3097R/L-CB	2.46	0.097	0.005 - 0.010	●	●	0.180	0.3750	0.195	0.344	0.4050
FLG-3125R/L-CB	3.18	0.125	0.005 - 0.010	●	●	0.180	0.3750	0.195	0.344	0.4050
FLG-3189R/L-CB	4.80	0.189	0.020 - 0.025	●	●	0.180	0.3750	0.195	0.344	0.4050

● : Line up

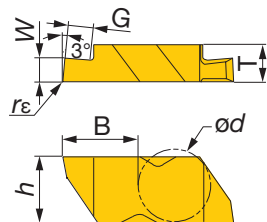

Designation	$W \pm 0.025$		$r\epsilon$ (in)	AH110		G (in)	ϕd (in)	T (in)	h (in)	B (in)
	(mm)	(in)		R	L					
FLG-2031R/L	0.79	0.031	0.002 - 0.005	●	●	0.050	0.1875	0.150	0.219	0.2700
FLG-2041R/L	1.04	0.041	0.002 - 0.005	●	●	0.050	0.1875	0.150	0.219	0.2700
FLG-2047R/L	1.19	0.047	0.002 - 0.005	●	●	0.050	0.1875	0.150	0.219	0.2700
FLG-2058R/L	1.47	0.058	0.005 - 0.010	●	●	0.050	0.1875	0.150	0.219	0.2700
FLG-2062R/L	1.57	0.062	0.005 - 0.010	●	●	0.110	0.1875	0.150	0.219	0.2700
FLG-2094R/L	2.39	0.094	0.005 - 0.010	●	●	0.110	0.1875	0.150	0.219	0.2700
FLG-2125R/L	3.18	0.125	0.005 - 0.010	●	●	0.110	0.1875	0.150	0.219	0.2700
FLG-3031R/L	0.79	0.031	0.002 - 0.005	●	●	0.050	0.3750	0.195	0.344	0.4050
FLG-3047R/L	1.19	0.047	0.005 - 0.010	●	●	0.075	0.3750	0.195	0.344	0.4050
FLG-3062R/L	1.57	0.062	0.005 - 0.010	●	●	0.120	0.3750	0.195	0.344	0.4050
FLG-3072R/L	1.83	0.072	0.005 - 0.010	●	●	0.120	0.3750	0.195	0.344	0.4050
FLG-3078R/L	1.98	0.078	0.005 - 0.010	●	●	0.120	0.3750	0.195	0.344	0.4050
FLG-3088R/L	2.24	0.088	0.005 - 0.010	●	●	0.180	0.3750	0.195	0.344	0.4050
FLG-3094R/L	2.39	0.094	0.005 - 0.010	●	●	0.180	0.3750	0.195	0.344	0.4050
FLG-3097R/L	2.46	0.097	0.010 - 0.015	●	●	0.180	0.3750	0.195	0.344	0.4050
FLG-3105R/L	2.67	0.105	0.005 - 0.010	●	●	0.180	0.3750	0.195	0.344	0.4050
FLG-3110R/L	2.79	0.110	0.005 - 0.010	●	●	0.180	0.3750	0.195	0.344	0.4050
FLG-3122R/L	3.10	0.122	0.005 - 0.010	●	●	0.180	0.3750	0.195	0.344	0.4050
FLG-3125R/L	3.18	0.125	0.005 - 0.010	●	●	0.180	0.3750	0.195	0.344	0.4050
FLG-3142R/L	3.61	0.142	0.005 - 0.010	●	●	0.180	0.3750	0.195	0.344	0.4050
FLG-3156R/L	3.96	0.156	0.005 - 0.010	●	●	0.180	0.3750	0.195	0.344	0.4050
FLG-3178R/L	4.52	0.178	0.005 - 0.010	●	●	0.180	0.3750	0.195	0.344	0.4050
FLG-3185R/L	4.70	0.185	0.020 - 0.025	●	●	0.180	0.3750	0.195	0.344	0.4050
FLG-3189R/L	4.80	0.189	0.020 - 0.025	●	●	0.180	0.3750	0.195	0.344	0.4050
FLG-3250R/L	6.35	0.250	0.020 - 0.025	●	●	0.180	0.3750	0.250	0.344	0.4050

● : Line up

FLGP (Positive rake)

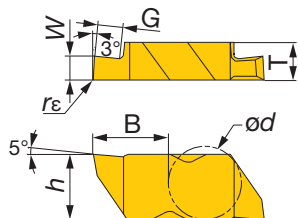

Designation	$W \pm 0.025$		$r\epsilon$ (in)	AH110		G (in)	ϕd (in)	T (in)	h (in)	B (in)
	(mm)	(in)		R	L					
FLGP-2031R/L	0.79	0.031	0.002 - 0.005	●	●	0.050	0.1875	0.150	0.219	0.2700
FLGP-2062R/L	1.57	0.062	0.005 - 0.010	●	●	0.110	0.1875	0.150	0.219	0.2700
FLGP-2125R/L	3.18	0.125	0.005 - 0.010	●	●	0.110	0.1875	0.150	0.219	0.2700
FLGP-3047R/L	1.19	0.047	0.005 - 0.010	●	●	0.075	0.3750	0.195	0.344	0.4050
FLGP-3062R/L	1.57	0.062	0.005 - 0.010	●	●	0.120	0.3750	0.195	0.344	0.4050
FLGP-3088R/L	2.24	0.088	0.005 - 0.010	●	●	0.180	0.3750	0.195	0.344	0.4050
FLGP-3094R/L	2.39	0.094	0.005 - 0.010	●	●	0.180	0.3750	0.195	0.344	0.4050
FLGP-3125R/L	3.18	0.125	0.005 - 0.010	●	●	0.180	0.3750	0.195	0.344	0.4050
FLGP-3156R/L	3.96	0.156	0.005 - 0.010	●	●	0.180	0.3750	0.195	0.344	0.4050
FLGP-3189R/L	4.80	0.189	0.020 - 0.025	●	●	0.180	0.3750	0.195	0.344	0.4050

● : Line up



FLR-CB (Full nose radius, with chipbreaker)

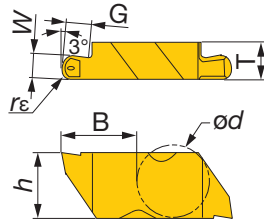

Designation	$W_{\pm 0.025}$ (mm)	$W_{\pm 0.001}$ (in)	r_{ϵ} (in)	AH110		G (in)	ϕd (in)	T (in)	h (in)	B (in)
				R	L					
FLR-3031R/L-CB	1.57	0.062	0.031	●	●	0.125	0.3750	0.195	0.344	0.4033
FLR-3047R/L-CB	2.39	0.094	0.047	●	●	0.180	0.3750	0.195	0.344	0.4025
FLR-3062R/L-CB	3.18	0.125	0.062	●	●	0.180	0.3750	0.195	0.344	0.4017

● : Line up

FLR (Full nose radius)

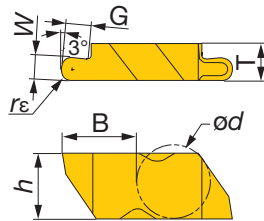

Designation	$W_{\pm 0.025}$ (mm)	$W_{\pm 0.001}$ (in)	r_{ϵ} (in)	AH110		G (in)	ϕd (in)	T (in)	h (in)	B (in)
				R	L					
FLR-2031R/L	1.57	0.062	0.031	●	●	0.110	0.1875	0.150	0.219	0.2683
FLR-2047R/L	2.39	0.094	0.047	●	●	0.110	0.1875	0.150	0.219	0.2675
FLR-2062R/L	3.18	0.125	0.062	●	●	0.110	0.1875	0.150	0.219	0.2667
FLR-3031R/L	1.57	0.062	0.031	●	●	0.125	0.3750	0.195	0.344	0.4033
FLR-3047R/L	2.39	0.094	0.047	●	●	0.180	0.3750	0.195	0.344	0.4025
FLR-3062R/L	3.18	0.125	0.062	●	●	0.180	0.3750	0.195	0.344	0.4017
FLR-3078R/L	3.96	0.156	0.078	●	●	0.180	0.3750	0.195	0.344	0.4008
FLR-3094R/L	4.80	0.189	0.094	●	●	0.180	0.3750	0.195	0.344	0.4000

● : Line up

FLRP (Full nose radius and positive rake)

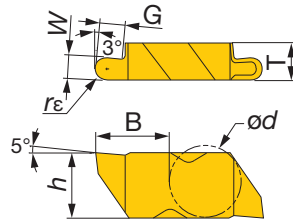

Designation	$W_{\pm 0.025}$ (mm)	$W_{\pm 0.001}$ (in)	r_{ϵ} (in)	AH110		G (in)	ϕd (in)	T (in)	h (in)	B (in)
				R	L					
FLRP-3031R/L	1.57	0.062	0.031	●	●	0.125	0.3750	0.195	0.344	0.4033
FLRP-3047R/L	2.39	0.094	0.047	●	●	0.180	0.3750	0.195	0.344	0.4025
FLRP-3062R/L	3.18	0.125	0.062	●	●	0.180	0.3750	0.195	0.344	0.4017
FLRP-3078R/L	3.96	0.156	0.078	●	●	0.180	0.3750	0.195	0.344	0.4008
FLRP-3094R/L	4.80	0.189	0.094	●	●	0.180	0.3750	0.195	0.344	0.4000

● : Line up

FLGD-CB (Single edge deep, with chipbreaker)

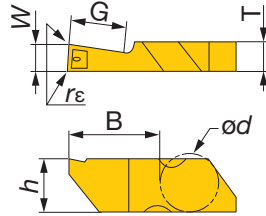

Designation	$W_{\pm 0.025}$ (mm)	$W_{\pm 0.001}$ (in)	r_{ϵ} (in)	AH110		G (in)	ϕd (in)	T (in)	h (in)	B (in)
				R	L					
FLGD-3094R/L-CB	2.39	0.094	0.005 - 0.010	●	●	0.250	0.3750	0.195	0.344	0.5050
FLGD-3125R/L-CB	3.18	0.125	0.005 - 0.010	●	●	0.250	0.3750	0.195	0.344	0.5050
FLGD-3189R/L-CB	4.80	0.189	0.020 - 0.025	●	●	0.250	0.3750	0.195	0.344	0.5050

● : Line up

FLGD (Single edge deep)

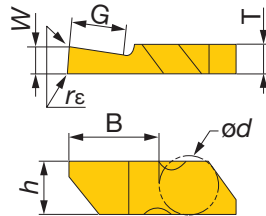

Designation	$W_{\pm 0.025}$ (mm)	$W_{\pm 0.001}$ (in)	r_{ϵ} (in)	AH110		G (in)	ϕd (in)	T (in)	h (in)	B (in)
				R	L					
FLGD-3062R/L	1.57	0.062	0.005 - 0.010	●	●	0.120	0.3750	0.195	0.344	0.5050
FLGD-3094R/L	2.39	0.094	0.005 - 0.010	●	●	0.250	0.3750	0.195	0.344	0.5050
FLGD-3125R/L	3.18	0.125	0.005 - 0.010	●	●	0.250	0.3750	0.195	0.344	0.5050
FLGD-3189R/L	4.8	0.189	0.020 - 0.025	●	●	0.250	0.3750	0.195	0.344	0.5050

● : Line up

FLRD (Full nose radius, single edge deep)

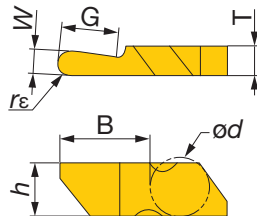

Designation	$W_{\pm 0.025}$ (mm)	$W_{\pm 0.001}$ (in)	r_{ϵ} (in)	AH110		G (in)	ϕd (in)	T (in)	h (in)	B (in)
				R	L					
FLRD-3062R/L	3.19	0.125	0.062	●	●	0.250	0.3750	0.195	0.344	0.5016
FLRD-3094R/L	4.8	0.189	0.094	●	●	0.250	0.3750	0.195	0.344	0.5016

● : Line up

FLGT (Double end deep)

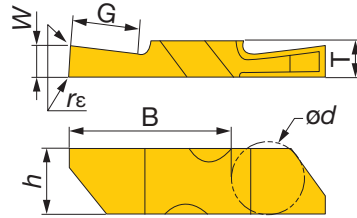

Designation	W±0.025 (mm)	W±0.001 (in)	rε (in)	AH110		G (in)	ød (in)	T (in)	h (in)	B (in)
				R	L					
FLGT-3094R/L	2.39	0.094	0.005 - 0.010	●	●	0.275	0.3750	0.195	0.344	0.8550
FLGT-3125R/L	3.18	0.125	0.005 - 0.010	●	●	0.437	0.3750	0.195	0.344	0.8550
FLGT-3189R/L	4.8	0.189	0.020 - 0.025	●	●	0.437	0.3750	0.195	0.344	0.8550

*Fits FLSLT/RT toolholders

● : Line up

FLRT (Double end deep FNR)

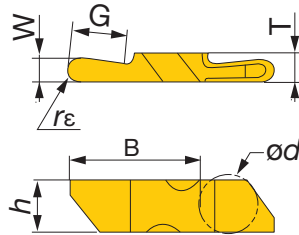

Designation	W±0.025 (mm)	W±0.001 (in)	rε (in)	AH110		G (in)	ød (in)	T (in)	h (in)	B (in)
				R	L					
FLRT-3062R/L	3.18	0.125	0.062	●	●	0.437	0.3750	0.195	0.344	0.8550
FLRT-3094R/L	4.80	0.189	0.094	●	●	0.437	0.3750	0.195	0.344	0.8550

*Fits FLSLT/RT toolholders

● : Line up

FLT-CB (For threading)

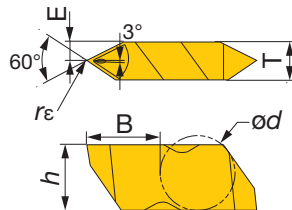

Designation	rε (in)	AH725		TPI		ød (in)	E (in)	T (in)	h (in)	B (in)
		R	L	Internal	External					
FLT-3R/L-HCB	0.005 - 0.008	●	●	5-12	6-20	0.3750	0.098	0.195	0.344	0.3999
FLT-3R/LC-HCB	0.012 - 0.015	●	●	5-6	6-11	0.3750	0.098	0.195	0.344	0.3999
FLT-3R/L-CB	0.005 - 0.008	●	●	8-12	8-20	0.3750	0.098	0.195	0.344	0.3999

● : Line up

STANDARD CUTTING CONDITIONS

ISO	Workpiece material	Grade	Application	Cutting speed Vc (sfm)	Feed f (ipr)
P	High carbon steel 1045, etc.	AH110	Grooving	328 - 656	0.005 - 0.014
		AH725	Threading	262 - 591	-
M	Alloy steel 4137, etc.	AH110	Grooving	164 - 262	0.005 - 0.012
		AH725	Threading	197 - 525	-
K	Stainless steel S30400, etc.	AH110	Grooving	164 - 492	0.004 - 0.005
		AH725	Threading	164 - 427	-
K	Gray cast iron No.250B, etc.	AH110	Grooving	164 - 591	0.004 - 0.010
		AH725	Threading	-	-
K	Ductile cast iron 60-40-18, etc.	AH110	Grooving	164 - 394	0.004 - 0.010
		AH725	Threading	-	-

SNGR/L

Toolholders for internal grooving



Grooving Tool

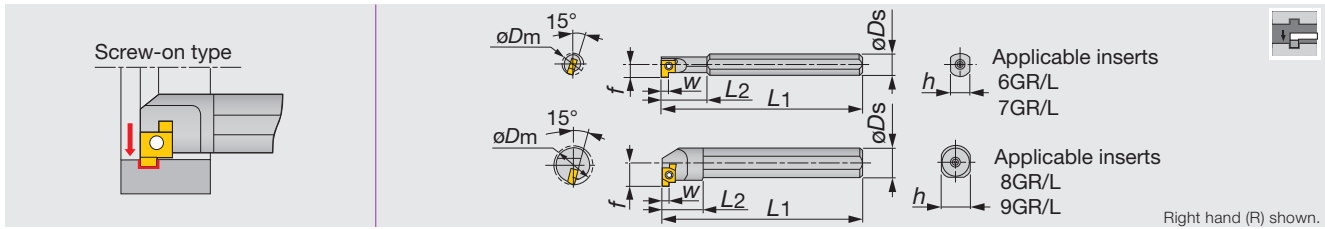

Metric	Material	W	ϕD_m	ϕD_s	f	L1	L2	h	Max. groove depth	Insert
SNGR/L08H06	STEEL	1 - 2	8	8	4.7	100	18	7	1.5	6GR/L...
SNGR/L08H07	STEEL	1 - 2	10	8	5.8	100	23	7	1.5	7GR/L...
SNGR/L10K07	STEEL	1 - 2	12	10	6.8	125	29	9	1.5	7GR/L...
SNGR/L10K08	STEEL	1.5 - 3.5	14	10	7.6	125	15	9	2	8GR/L...
SNGR/L12M08	STEEL	1.5 - 3.5	16	12	8.6	150	18	11	2	8GR/L...
SNGR/L16Q09	STEEL	1.5 - 3.5	20	16	11.6	180	20	15	3	9GR/L...
SNGR/L20R09	STEEL	1.5 - 3.5	24	20	13.6	200	25	18	3	9GR/L...
SNGR/L08K06SC	CARBIDE	1.5 - 3.5	8	8	4.7	125	28	7	1.5	6GR/L...
SNGR/L08K07SC	CARBIDE	1.5 - 3.5	10	8	5.8	125	35	7	1.5	7GR/L...
SNGR/L10M07SC	CARBIDE	1.5 - 3.5	12	10	6.8	150	45	9	1.5	7GR/L...
SNGR/L10M08SC	CARBIDE	1.5 - 3.5	14	10	7.6	150	45	9	2	8GR/L...
SNGR/L12Q08SC	CARBIDE	1.5 - 3.5	16	12	8.6	180	-	11	2	8GR/L...
SNGR/L16R09SC	CARBIDE	1.5 - 3.5	20	16	11.6	200	-	15	3	9GR/L...

SPARE PARTS



Designation	Clamping screw	Wrench
SNGR/L***06	CSTB-2L040	T-6F
SNGR/L***07	CSTB-2.2S	T-7F
SNGR/L***08	CSTB-2.2	T-7F
SNGR/L***09	CSTB-2.5L080	T-8F
SNGR/L***06SC	CSTB-2L040	T-6F
SNGR/L***07SC	CSTB-2.2S	T-7F
SNGR/L***08SC	CSTB-2.2	T-7F
SNGR/L***09SC	CSTB-2.5L080	T-8F



Internal

Reference pages

Inserts, Standard cutting conditions → C033

**CNGR/L**

Toolholders for internal grooving

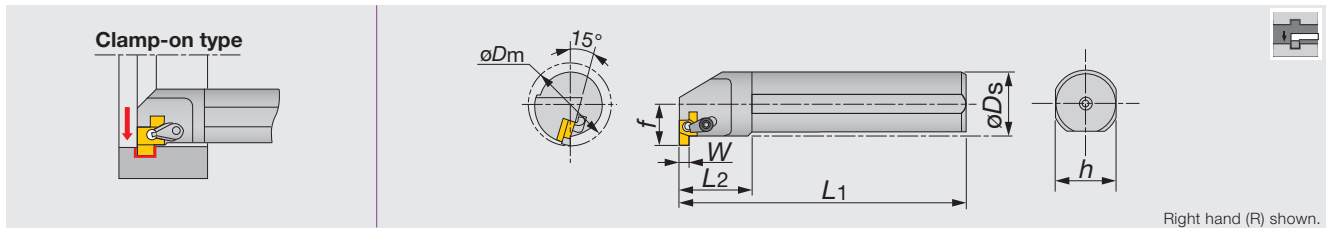

Metric	W	ϕD_m	ar	ϕD_s	f	L1	L2	h	Insert
CNGR/L25S15	2 - 5	32	5	25	18.1	250	30	23	15GR/L...
CNGR/L32T15	2 - 5	40	5	32	22.1	300	35	30	15GR/L...
CNGR/L40U15	2 - 5	48	5	40	26.1	350	45	38	15GR/L...

SPARE PARTS

Designation	Clamp set	Screw	Shim	Wrench
CNGR...	CSP22	DTS5-3.5	SGSR151	T-20F
CNGL...	CSP22	DTS5-3.5	SGSL151	T-20F

Optional parts for CNG type toolholders

When using as a screw-on type, use the following parts.



Designation	Clamping screw	Wrench
CNGR/L...	CSTB-3.5L	T-15F



INSERT

**GR/L

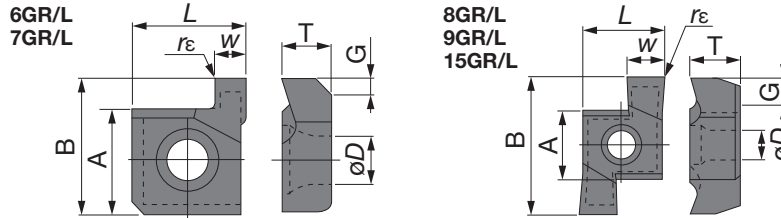

Right hand (R) shown.

Designation	W±0.025 (mm)	W±0.001 (in)	rε (in)	Cermet		Uncoated				A (in)	B (in)	T (in)	øD (in)	L (in)	G (in)
				NS9530		TH10		UX30							
				R	L	R	L	R	L						
6GR/L100	1	0.039	0.008	●		●		●	●	0.187	0.254	0.092	0.091	0.219	0.059
6GR/L150	1.5	0.059	0.008	●		●	●	●	●	0.187	0.254	0.092	0.091	0.219	0.059
6GR/L200	2	0.079	0.008	●		●	●	●	●	0.187	0.254	0.092	0.091	0.219	0.059
7GR/L100	1	0.039	0.008	●		●		●		0.219	0.290	0.121	0.102	0.219	0.059
7GR/L150	1.5	0.059	0.008	●		●		●		0.219	0.290	0.121	0.102	0.219	0.059
7GR/L200	2	0.079	0.008	●		●	●	●	●	0.219	0.290	0.121	0.102	0.219	0.059
8GR/L150	1.5	0.059	0.008	●		●		●		0.219	0.400	0.152	0.102	0.242	0.079
8GR/L200	2	0.079	0.008	●		●	●	●		0.219	0.400	0.152	0.102	0.242	0.079
8GR/L250	2.5	0.098	0.008	●		●	●	●	●	0.219	0.400	0.152	0.102	0.242	0.079
8GR/L300	3	0.118	0.008	●		●	●	●	●	0.219	0.400	0.152	0.102	0.242	0.079
8GR/L350	3.5	0.138	0.008			●		●		0.219	0.400	0.152	0.102	0.242	0.079
9GR/L150	1.5	0.059	0.008	●	●	●		●	●	0.250	0.510	0.183	0.102	0.305	0.079
9GR/L200	2	0.079	0.008	●	●	●	●	●	●	0.250	0.510	0.183	0.102	0.305	0.118
9GR/L250	2.5	0.098	0.008	●	●	●		●	●	0.250	0.510	0.183	0.102	0.305	0.118
9GR/L300	3	0.118	0.008	●	●	●	●	●	●	0.250	0.510	0.183	0.102	0.305	0.118
9GR/L350	3.5	0.138	0.008	●	●	●		●	●	0.250	0.510	0.183	0.102	0.305	0.118
15GR/L200	2	0.079	0.008	●		●		●		0.362	0.819	0.201	0.189	0.425	0.118
15GR/L250	2.5	0.098	0.008	●		●		●		0.362	0.819	0.201	0.189	0.425	0.118
15GR/L300	3	0.118	0.008	●		●		●	●	0.362	0.819	0.201	0.189	0.425	0.118
15GR/L350	3.5	0.138	0.008	●		●		●		0.362	0.819	0.201	0.189	0.425	0.118
15GR/L400	4	0.157	0.008	●		●		●		0.362	0.819	0.201	0.189	0.425	0.157
15GR/L450	4.5	0.177	0.008			●	●	●		0.362	0.819	0.201	0.189	0.425	0.157
15GR/L500	5	0.197	0.008			●		●		0.362	0.819	0.201	0.189	0.425	0.197

Note:

When using a right or left hand insert, the right hand insert is used with right hand toolholder and the left hand insert is used with left hand toolholder.

● : Line up

STANDARD CUTTING CONDITIONS

ISO	Workpiece material	Cutting speed Vc (sfm)	Feed f (ipr)
P	Medium carbon steels (S45C)	130 - 500	0.002 - 0.006
K	Cast irons, Light alloys	200 - 650	0.002 - 0.006

Notes:

- Cutting conditions shown above are a guideline only.
- When grooving close to the minimum bore diameter or with long reach conditions, reduce the conditions shown above by approximately 50%.
- To help chip evacuation, use water-soluble cutting fluid. The fluid should be applied sufficiently to the cutting point.
- When using without cutting fluid, reduce both the cutting speeds and feeds shown on the above by 50% at least.

**CGXR/L**

Toolholders for internal grooving

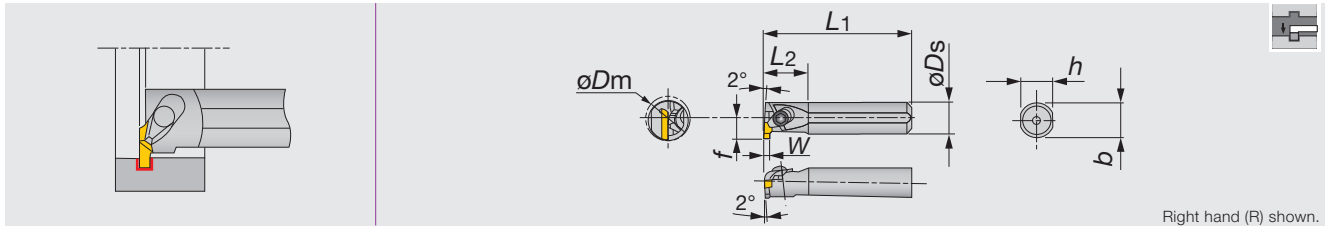

Metric	Material	W	ϕD_m	ϕD_s	f	L ₁	L ₂	h	b	Max. groove depth	Insert
CGXR/L0016	STEEL	1 - 3	20	16	11.3	150	24	15	15.5	3	GIR/L52...
CGXR/L0020	STEEL	1 - 3	24	20	13.3	180	30	18	19	3	GIR/L52...
CGXR/L0025	STEEL	1 - 5	32	25	18	200	38	23	24	5.3	GIR/L63...
CGXR/L0032	STEEL	1 - 5	40	32	23	250	48	30	31	5.3	GIR/L63...
CGXR/L0040	STEEL	1 - 5	48	40	27	300	60	37	38.5	5.3	GIR/L63...
CGXR/L16SC	CARBIDE	1 - 3	20	16	11.3	200	24	15	-	3	GIR/L52...

• When using a right or left hand insert, the right hand insert (GIR) is used for the right hand toolholders (CGXR), and the left hand insert (GIL) is used for the left hand toolholders (CGXL).

SPARE PARTS

Designation	Clamp set	Wrench 1	Wrench 2
CGXR/L0016/20	CSW-0	-	P-2.5T
CGXR/L0025/32/40	CSW-2	P-4	-
CGXR/L16SC	CSW-0	-	P-2.5T



Reference pages

Inserts, Standard cutting conditions → **C035**

INSERT

GIR/L

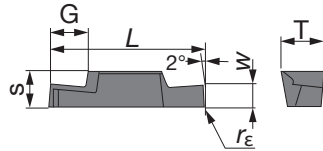

Right hand (R) shown.

Designation	W±0.05 (mm)	rε (mm)	Cermet		S (mm)	T (mm)	L (mm)	G (mm)
			NS9530	TH10				
GIR5210-02	1	0.2	●	●	3.5	4.4	15	1.5
GIR5215-02	1.5	0.2	●	●	3.5	4.4	15	2.3
GIR5220-02	2	0.2	●	●	3.5	4.4	15	3
GIR5225-02	2.5	0.2	●	●	3.5	4.4	15	3
GIR5230-02	3	0.2	●	●	3.5	4.4	15	3
GIR6310-02	1	0.2	●	●	5.5	6.4	24	1.5
GIR6315-02	1.5	0.2	●	●	5.5	6.4	24	2.3
GIR6320-02	2	0.2	●	●	5.5	6.4	24	3
GIR6325-02	2.5	0.2	●	●	5.5	6.4	24	3.8
GIR6330-02	3	0.2	●	●	5.5	6.4	24	4.5
GIR6335-02	3.5	0.2	●	●	5.5	6.4	24	5.3
GIR6340-02	4.0	0.2	●	●	5.5	6.4	24	5.3
GIR6345-02	4.5	0.2	●	●	5.5	6.4	24	5.3
GIR6350-02	5	0.2	●	●	5.5	6.4	24	5.3

Note:

● : Line up

When using a right or left hand insert, the right hand insert is used with right hand toolholder and the left hand insert is used with left hand toolholder.

STANDARD CUTTING CONDITIONS (EXTERNAL & INTERNAL GROOVING)

ISO	Workpiece material	Grade	Cutting speed Vc (sfm)	Feed f (ipr)		
				W < 0.079"	W = 0.079" - 0.157"	W > 0.157"
P	Carbon steels	NS9530	260 - 500	0.002 - 0.004	0.003 - 0.006	0.003 - 0.008
K	Cast irons, Light alloys	TH10	200 - 500	0.002 - 0.004	0.003 - 0.006	0.003 - 0.008



Grooving Tool

GX-R/LE

External toolholders for grooving, with double-ended inserts

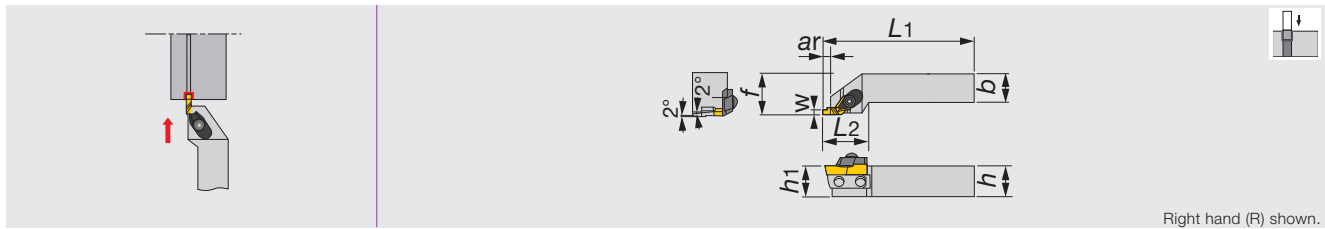

Right hand (R) shown.

Inch	W	ar	h	b	L1	L2	h1	f	Insert
GX-1212REU	0.039 - 0.177	0.059 - 0.236	0.75	0.75	5.00	1.38	0.75	1.00	XGR63...
GX-1616REU	0.039 - 0.177	0.059 - 0.236	1.00	1.00	5.90	1.38	1.00	1.25	XGR63...

Metric	W	ar	h	b	L1	L2	h1	f	Insert
GX-2020R/LE	1 - 4.5	1.5 - 6	20	20	125	35	20	25	XGR/L63...
GX-2525R/LE	1 - 4.5	1.5 - 6	25	25	150	35	25	32	XGR/L63...

• When using a right or left hand insert, the right hand insert (XGR) is used for the right hand toolholders (GX-****RE) , and the left hand insert (XGL) is used for the left hand toolholders (GX-****LE).

SPARE PARTS

Designation	Clamp set	Clamp screw	Shim	Shim screw	Wrench
GX-1212REU, GX-2020RE	CP81A	RT-1	SL-6R	BHM4-8	P-4
GX-2020LE	CP81A	RT-1	SL-6L	BHM4-8	P-4
GX-1616REU, GX-2525RE	CP81A	RT-1	SL-1R	BHM4-8	P-4
GX-2525LE	CP81A	RT-1	SL-1L	BHM4-8	P-4

Note:

Max.groove width and max. groove depth shown in the above table are the values when the insert having the largest cutting edge width is used.

GX-R/LI

Toolholders for internal grooving

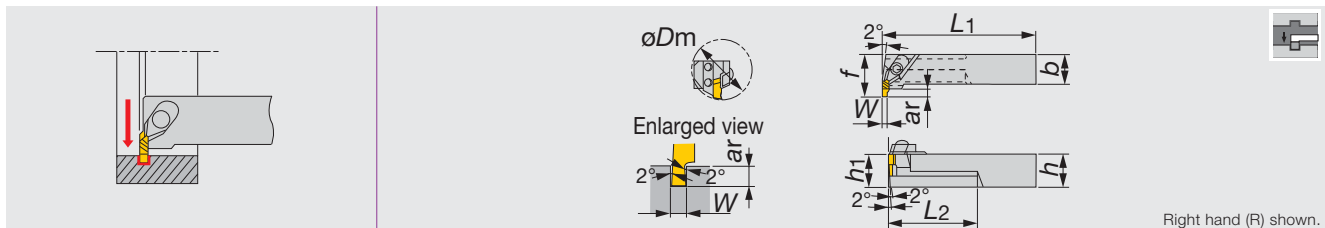

Right hand (R) shown.

Inch	W	øDm	ar	h	b	L1	L2	h1	f	Insert
GX-1212RIU	0.039 - 0.177	2.165	0.059 - 0.236	0.750	0.75	6.30	2.36	0.75	1.37	XGL63...
GX-1616RIU	0.039 - 0.177	2.165	0.059 - 0.236	1.00	1.00	7.87	1.96	1.00	1.37	XGL63...

Metric	W	øDm	ar	h	b	L1	L2	h1	f	Insert
GX-2525R/LI	1 - 4.5	55	1.5 - 6	25	25	200	70	25	35	XGL/R63...

• When using a right or left hand insert, the right hand insert (XGR) is used for the left hand toolholders (GX-****LI) , and the left hand insert (XGL) is used for the right hand toolholders (GX-****RI).

SPARE PARTS

Designation	Clamp set	Clamp screw	Shim	Shim screw	Wrench
GX-1212RIU	CP81B	RT-1	SL-7R	BHM4-8	P-4
GX-2525RI	CP81B	RT-1	SL-2R	BHM3-8	P-4
GX-1616RIU, GX-2525LI	CP81B	RT-1	SL-2L	BHM3-8	P-4

Reference pages

Inserts, Standard cutting conditions → C037



INSERT

XGR/L

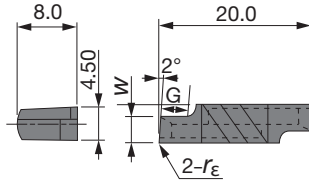

Right hand (R) shown.

Designation	$W_{\pm 0.05}$ (mm)	$W_{\pm 0.002}$ (in)	r_{ϵ} (mm)	Cermet		Uncoated		G (mm)		
				NS9530		TH10			UX30	
				R	L	R	L		R	L
XGR/L6310-02	1	0.039	0.2	●	●	●	●	●	1.5	
XGR/L6315-02	1.5	0.059	0.2	●	●	●	●	●	2.3	
XGR/L6320-02	2	0.079	0.2	●	●	●	●	●	3	
XGR/L6325-02	2.5	0.098	0.2	●	●	●	●	●	3.8	
XGR/L6330-02	3	0.118	0.2	●	●	●	●	●	4.5	
XGR/L6335-02	3.5	0.138	0.2	●	●	●	●	●	5.3	
XGR/L6340-02	4	0.157	0.2	●	●	●	●	●	6	
XGR/L6345-02	4.5	0.177	0.2	●	●	●	●	●	6	

Note;

For internal machining, use right-hand toolholder (GX-****R) with left-hand insert (XGL****), and use left-hand toolholder (GX-****L) with right-hand insert (XGR****).
For external machining, use right-hand toolholder (GX-****RE) with right-hand insert (XGR****), and use left-hand toolholder (GX-****LE) with left-hand insert (XGL****).

● : Line up

XGR/L-QBN

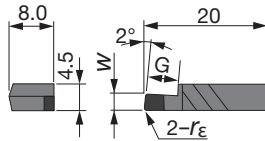

Right hand (R) shown.

Designation	$W_{\pm 0.05}$ (mm)	$W_{\pm 0.002}$ (in)	r_{ϵ} (mm)	T-CBN		G (mm)
				BX360		
				R	L	
XGL6310S-QBN	1	0.039	0.2		●	2.3
XGR/L6315S-QBN	1.5	0.059	0.2	●	●	2.3
XGR/L6320S-QBN	2	0.079	0.2	●	●	3
XGR/L6325S-QBN	2.5	0.098	0.2	●	●	3.8
XGR/L6330S-QBN	3	0.118	0.2	●	●	4.5
XGR/L6335S-QBN	3.5	0.138	0.2	●	●	5.3
XGR/L6340S-QBN	4	0.157	0.2	●	●	6
XGR/L6345S-QBN	4.5	0.177	0.2	●	●	6

● : Line up

Note;

For internal machining, use right-hand toolholder (GX-****R) with left-hand insert (XGL****), and use left-hand toolholder (GX-****L) with right-hand insert (XGR****).
For external machining, use right-hand toolholder (GX-****RE) with right-hand insert (XGR****), and use left-hand toolholder (GX-****LE) with left-hand insert (XGL****).

STANDARD CUTTING CONDITIONS

ISO	Workpiece material	Grade	Cutting speed v_c (sfm)	Feed f (ipr)		
				$W < 0.078''$	$W = 0.078'' - 0.157''$	$W > 0.157''$
P	Carbon steels	NS9530	260 - 650	0.001 - 0.004	0.003 - 0.008	0.003 - 0.010
		TX10S	200 - 500	0.001 - 0.004	0.003 - 0.008	0.003 - 0.010
		UX30	200 - 500	0.001 - 0.004	0.003 - 0.008	0.003 - 0.010
K	Cast irons , Light alloys	TH10	200 - 500	0.001 - 0.004	0.003 - 0.008	0.003 - 0.010
H	Hardened steels	BX360	60 - 500	0.001 - 0.15	0.001 - 0.15	0.001 - 0.006

GX-R/LF

Toolholders for face grooving

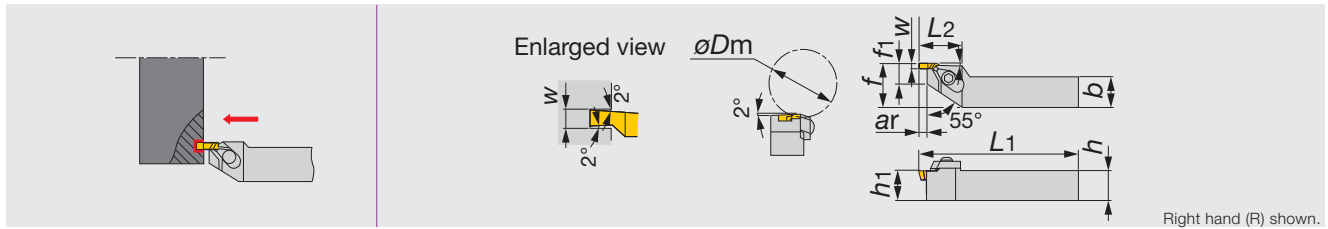

Metric	W	ϕD_m	ar	h	b	L1	L2	h1	f	f1	Insert
GX-2525R/LF	1 - 4.5	55	1.5 - 6	25	25	150	35	25	32	15	XNL/R63...

• When using a right or left hand insert, the right hand insert (XNR) is used for the left hand toolholders (GX-...LF), and the left hand insert (XNL) is used for the right hand toolholders (GX-...RF).

SPARE PARTS

Designation	Clamp set	Clamping screw	Shim	Shim screw	Wrench
GX-2525RF	CP81A	RT-1	SL-3R	BHM4-8	P-4
GX-2525LF	CP81A	RT-1	SL-3L	BHM4-8	P-4

INSERT

XNR/L

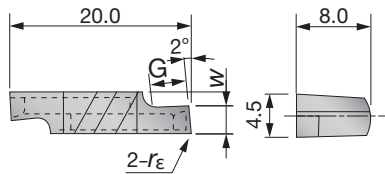

Designation	W \pm 0.05 (mm)	r ϵ (mm)	Cermet NS9530		Uncoated TH10		G (mm)
			R	L	R	L	
XNR/L6310-02	1	0.2	●	●	●	●	1.5
XNR/L6315-02	1.5	0.2	●	●	●	●	2.3
XNR/L6320-02	2	0.2	●	●	●	●	3
XNR/L6325-02	2.5	0.2	●	●	●	●	3.8
XNR/L6330-02	3	0.2	●	●	●	●	4.5
XNR/L6335-02	3.5	0.2	●	●	●	●	5.3
XNR/L6340-02	4	0.2	●	●	●	●	6
XNR/L6345-02	4.5	0.2	●	●	●	●	6

● : Line up



Face Grooving

TGTSR/L

External toolholders for grooving, with triple corner insert



Grooving Tool

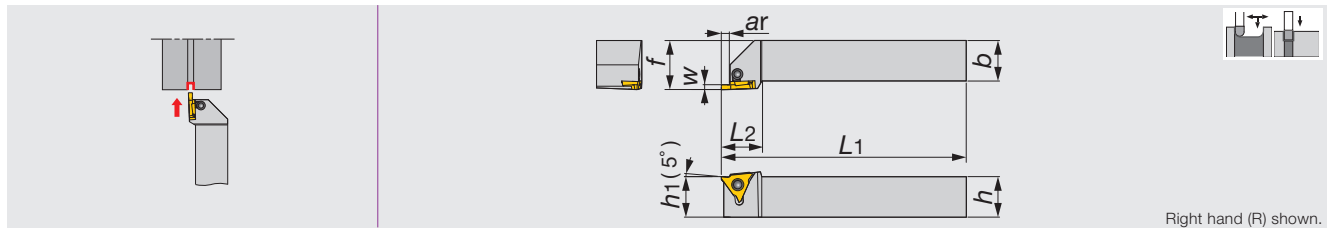

Inch	W	ar	h	b	L1	L2	h1	f
TGTSR16-3	0.013 ~ 0.100	0.110	1.00	1.00	6	0.98	1.00	1.00
TGTSR16-4-1	0.040 ~ 0.057	0.100	1.00	1.00	6	1.00	1.00	1.00
TGTSR16-4-2	0.060 ~ 0.090	0.160	1.00	1.00	6	1.00	1.00	1.00
TGTSR16-4-3	0.100 ~ 0.180	0.210	1.00	1.00	6	1.00	1.00	1.00

Metric	W	ar	h	b	L1	L2	h1	f
TGTSR/L2020K16	0.33 - 2.5	2.5	20	20	125	25	20	25
TGTSR/L2525M16	0.33 - 2.5	2.5	25	25	150	25	25	30
TGTSR/L2020K22-1	1 - 1.45	2	20	20	125	25	20	25
TGTSR/L2020K22-2	1.5 - 2.3	3.5	20	20	125	25	20	25
TGTSR/L2020K22-3	2.5 - 4.5	5	20	20	125	25	20	25
TGTSR/L2525M22-1	1 - 1.45	2	25	25	150	25	25	30
TGTSR/L2525M22-2	1.5 - 2.3	3.5	25	25	150	25	25	30
TGTSR/L2525M22-3	2.5 - 4.5	5	25	25	150	25	25	30

- See below Applicable insert table.
- The right hand insert (GBR) is used for the right hand toolholders (TGTSR), and the left hand insert (GBL) is used for the left hand toolholders (TGTSL).

Designation	Applicable insert
TGTSR16-3	GBR/L32...
TGTSR16-4-1	GBR43050R ~ 145
TGTSR16-4-2	GBR43150 ~ 230
TGTSR16-4-3	GBR43250 ~ 450
TGTSR/L2020K16	GBR/L32...
TGTSR/L2525M16	GBR/L32...
TGTSR/L2020K22-1	GBR/L43125 ~ 145 GBR/L43050R
TGTSR/L2020K22-2	GBR/L43150 ~ 230 GBR/L43075R ~ 100R
TGTSR/L2020K22-3	GBR/L43250 ~ 450 GBR/L43125R ~ 200R
TGTSR/L2525M22-1	GBR/L43125 ~ 145 GBR/L43050R
TGTSR/L2525M22-2	GBR/L43150 ~ 230 GBR/L43075R ~ 100R
TGTSR/L2525M22-3	GBR/L43250 ~ 450 GBR/L43125R ~ 200R

SPARE PARTS



Designation	Clamp	Clamping screw	Wrench
TGTSR16-3	CP900	MCS520-2.5	P-2.5
TGTSR16-4...	CP910	MCS520-2.5	P-2.5
TGTSR/L****16	CP900	MCS520-2.5	P-2.5
TGTSR/L****22...	CP910	MCS520-2.5	P-2.5



External

Others

Reference pages

Inserts → C041 - C042, Standard cutting conditions → C042

TGTRR/L

Perpendicular toolholders for external grooving, with triple corner inserts

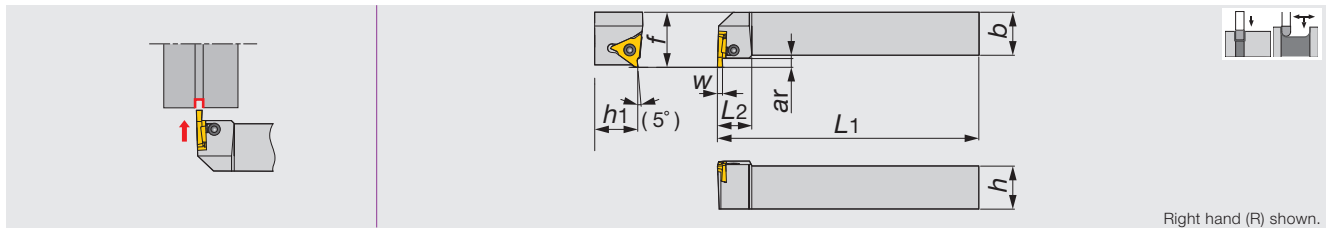

Right hand (R) shown.

Metric	W	ar	h	b	L1	L2	h1	f
TGTRR/L2020K16	0.33 - 2.5	2.5	20	20	125	20	20	27
TGTRR/L2525M16	0.33 - 2.5	2.5	25	25	150	20	25	32
TGTRR/L2020K22-1	1 - 1.45	2	20	20	125	20	20	27
TGTRR/L2020K22-2	1.5 - 2.3	3.5	20	20	125	20	20	27
TGTRR/L2020K22-3	2.5 - 4.5	5	20	20	125	20	20	27
TGTRR/L2525M22-1	1 - 2.3	2	25	25	150	20	25	32
TGTRR/L2525M22-2	1.5 - 2.3	3.5	25	25	150	20	25	32
TGTRR/L2525M22-3	2.5 - 4.5	5	25	25	150	20	25	32

• See below Applicable insert table.

• The left hand insert (GBL) is used for the right hand toolholders (TGTRR), and the right hand insert (GBR) is used for the left hand toolholders (TGTRL).

Designation	Applicable insert
TGTRR/L2020K16	GBL/R32...
TGTRR/L2525M16	GBL/R32...
TGTRR/L2020K22-1	GBL/R43125 ~ 145 GBL/R43050R
TGTRR/L2020K22-2	GBL/R43150 ~ 230 GBL/R43075R ~ 100R
TGTRR/L2020K22-3	GBL/R43250 ~ 450 GBL/R43125R ~ 200R
TGTRR/L2525M22-1	GBL/R43125 ~ 145 GBL/R43050R
TGTRR/L2525M22-2	GBL/R43150 ~ 230 GBL/R43075R ~ 100R
TGTRR/L2525M22-3	GBL/R43250 ~ 450 GBL/R43125R ~ 200R

SPARE PARTS

Designation	Clamp	Clamping screw	Wrench
TGTRR/L*****16	CP900	MCS520-2.5	P-2.5
TGTRR/L*****22...	CP910	MCS520-2.5	P-2.5



External



Internal

S-SGTR/L

Toolholders for internal grooving

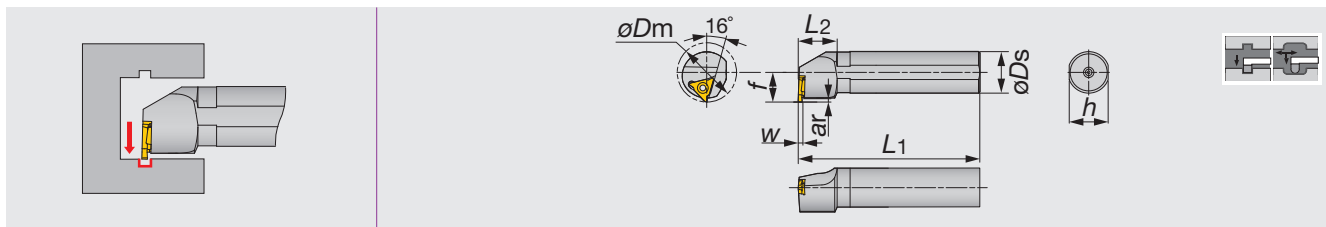

Right hand (R) shown.

Inch	W	øDm	ar	øDs	f	L1	L2	h	Insert
S16R-SGTR/L3	0.013 - 0.098	1.38	0.100	1.00	0.690	7.78	1.18	0.910	GBL/R32...
Metric	W	øDm	ar	øDs	f	L1	L2	h	Insert
S25R-SGTR/L16	0.33 - 2.5	35	2	25	17.5	200	30	23	GBL/R32...
S32S-SGTR/L22	1.25 - 4.5	40	2.5	32	23	250	30	30	GBL/R43...

• When using a right or left hand insert, the right hand insert (GBR) is used for the left hand toolholders (SGTL), and the left hand insert (GBL) is used for the right hand toolholders (SGTR).

SPARE PARTS

Designation	Clamping screw	Wrench
S16R-SGTR/L3	CSTB-4S	T-15F
S25R-SGTR/L16	CSTB-5S	T-20F
S32S-SGTR/L22	CSTB-5S	T-20F

Reference pages

Inserts → C041 - C042, Standard cutting conditions → C042

APPLICABLE INSERT

GBR/L32

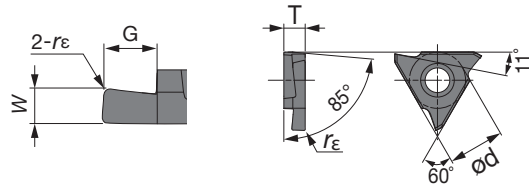

Right hand (R) shown.

Designation	$W_{\pm 0.025}$ (mm)	$W_{\pm 0.001}$ (in)	$r\epsilon$ (mm)	Coated		Cermet		Uncoated		G (mm)	ϕd (mm)	T (mm)
				AH710		NS9530		KS05F				
				R	L	R	L	R	L			
GBR/L32033	0.33	0.013	0.03	●	●	●		●		0.8	9.525	3.18
GBR/L32050	0.5	0.020	0.05	●	●	●		●		1.2	9.525	3.18
GBR/L32075	0.75	0.030	0.05	●	●	●	●	●		2	9.525	3.18
GBR/L32095	0.95	0.037	0.05	●	●	●	●	●		2	9.525	3.18
GBR/L32100	1	0.039	0.05	●	●	●	●	●		2	9.525	3.18
GBR/L32125	1.25	0.049	0.2	●	●	●	●	●		2	9.525	3.18
GBR/L32145	1.45	0.057	0.2	●	●	●		●		2	9.525	3.18
GBR/L32150	1.5	0.059	0.2	●	●	●		●		2	9.525	3.18
GBR/L32200	2	0.079	0.2	●	●	●		●		2.5	9.525	3.18
GBR/L32250	2.5	0.098	0.2	●	●	●		●		2.5	9.525	3.18

● : Line up

GBR/L43

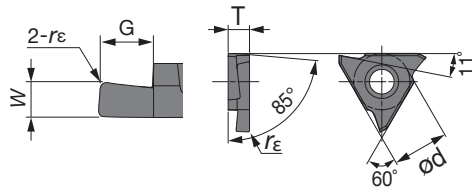

Right hand (R) shown.

Designation	$W_{\pm 0.025}$ (mm)	$W_{\pm 0.001}$ (in)	$r\epsilon$ (mm)	Coated		Cermet		Uncoated		G (mm)	ϕd (mm)	T (mm)
				AH710		NS9530		KS05F				
				R	L	R	L	R	L			
GBR/L43125	1.25	0.049	0.2	●	●	●		●		2	12.7	4.76
GBR/L43145	1.45	0.057	0.2	●	●	●		●		2	12.7	4.76
GBR/L43150	1.5	0.059	0.2	●	●	●	●	●		3.5	12.7	4.76
GBR/L43175	1.75	0.069	0.2	●	●	●	●	●		3.5	12.7	4.76
GBR/L43185	1.85	0.073	0.2	●	●	●	●	●		3.5	12.7	4.76
GBR/L43200	2	0.079	0.2	●	●	●	●	●		3.5	12.7	4.76
GBR/L43230	2.3	0.091	0.2	●	●	●	●	●		3.5	12.7	4.76
GBR/L43250	2.5	0.098	0.3	●	●	●		●		5	12.7	4.76
GBR/L43265	2.65	0.104	0.3	●	●	●		●		5	12.7	4.76
GBR/L43280	2.8	0.110	0.3	●	●	●		●		5	12.7	4.76
GBR/L43300	3	0.118	0.3	●	●	●		●		5	12.7	4.76
GBR/L43330	3.3	0.130	0.3	●	●	●		●		5	12.7	4.76
GBR/L43350	3.5	0.138	0.3	●	●	●		●		5	12.7	4.76
GBR/L43400	4	0.157	0.4	●	●	●		●		5	12.7	4.76
GBR/L43430	4.3	0.169	0.4	●	●	●		●		5	12.7	4.76
GBR/L43450	4.5	0.177	0.4	●	●	●		●		5	12.7	4.76

● : Line up

APPLICABLE INSERT

GBR/L43-R (Radius)

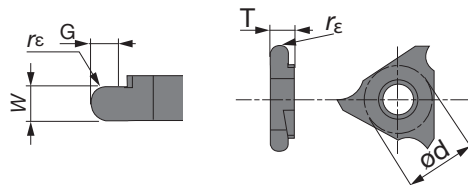

Right hand (R) shown.

Designation	W±0.025 (mm)	W±0.001 (in)	rε (mm)	Coated		Cermet		Uncoated		G (mm)	ød (mm)	T (mm)
				AH710		NS9530		KS05F				
				R	L	R	L	R	L			
GBR/L43050R	1	0.039	0.5	●	●	●	●	●	●	2	12.7	4.76
GBR/L43075R	1.5	0.059	0.75	●	●	●	●	●	●	3.5	12.7	4.76
GBR/L43100R	2	0.079	1	●	●	●	●	●	●	3.5	12.7	4.76
GBR/L43125R	2.5	0.098	1.25	●	●	●	●	●	●	5	12.7	4.76
GBR/L43150R	3	0.118	1.5	●	●	●	●	●	●	5	12.7	4.76
GBR/L43200R	4	0.157	2	●	●	●	●	●	●	5	12.7	4.76

● : Line up

STANDARD CUTTING CONDITIONS

ISO	Workpiece material	Hardness	Grade	Cutting speed Vc (sfm)	Feed f (ipr)
P	Carbon steels, Alloy steels 1045 SAE, 4140 SAE, etc.	150 - 240HB	NS9530	330 - 650	0.001 - 0.010
		150 - 240HB	AH710	200 - 500	0.002 - 0.010
M	Stainless steels 303, 304, etc.	≤ 240HB	AH710	200 - 500	0.002 - 0.010
K	Cast irons 250, etc.	Tensile strength ≤ 350 N/mm ²	AH710	200 - 500	0.002 - 0.010
N	Non-ferrous metals Aluminum, etc.	-	KS05F	650 - 980	0.002 - 0.010

SGTR/L

External toolholders for grooving, with triple corner inserts

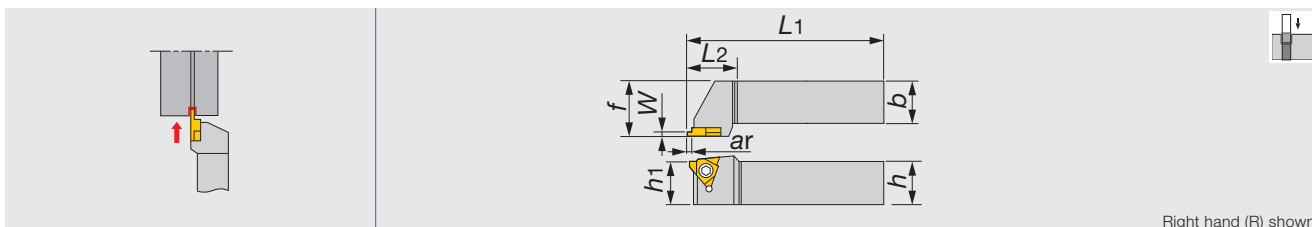

Right hand (R) shown.

Metric	W	ar	h	b	L1	L2	h1	f	Insert
SGTR1616-3	1.15 - 2.7	1.5 - 3	16	16	100	20	16	20	GLR/L3...
SGTR/L2020-3	1.15 - 2.7	1.5 - 3	20	20	125	20	20	25	GLR/L3...
SGTR/L2525-3	1.15 - 2.7	1.5 - 3	25	25	150	20	25	32	GLR/L3...
SGTR/L2020-4	1.15 - 4.2	1.5 - 4	20	20	125	30	20	25	GLR/L4...,GOR/L4...
SGTR/L2525-4	1.15 - 4.2	1.5 - 4	25	25	150	30	25	32	GLR/L4...,GOR/L4...

SPARE PARTS

Designation	Clamping screw	Wrench
SGTR/L***-3	CSTB-4	T-15F
SGTR/L***-4	CSTB-5	T-20F

Reference pages

Inserts, Standard cutting conditions → C043

APPLICABLE INSERT

GOR/L (O-ring)

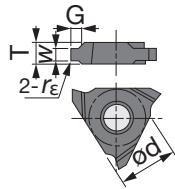

Right hand (R) shown.

Designation	$W_{+0.05}^{+0.1}$ (mm)	$W_{+0.002}^{+0.004}$ (in)	$r\epsilon$ (mm)	Cermet		Uncoated		G (mm)	ϕd (mm)	T (mm)
				NS9530		UX30				
				R	L	R	L			
GOR/L4190	2.5	0.098	0.4	●		●		1.5	12.7	4.76
GOR/L4240	3.2	0.126	0.4	●		●		2	12.7	4.76
GOR/L4310	4.1	0.161	0.7	●		●		2.5	12.7	4.76

● : Line up

GLR/L (Lock-ring)

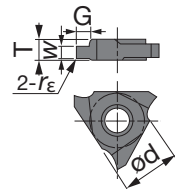

Right hand (R) shown.

Designation	$W_{+0.05}^{+0.1}$ (mm)	$W_{+0.002}^{+0.004}$ (in)	$r\epsilon$ (mm)	Cermet		Uncoated		G (mm)	ϕd (mm)	T (mm)
				NS9530		UX30				
				R	L	R	L			
GLR/L3115	1.15	0.045	0.1	●	●	●	●	1.5	9.525	3.18
GLR/L3135	1.35	0.053	0.1	●	●	●		1.5	9.525	3.18
GLR/L3165	1.65	0.065	0.1	●	●	●		2	9.525	3.18
GLR/L3175	1.75	0.069	0.1	●	●	●	●	2	9.525	3.18
GLR/L3195	1.95	0.077	0.1	●	●	●	●	2.5	9.525	3.18
GLR/L3220	2.2	0.087	0.1	●		●	●	3	9.525	3.18
GLR/L3270	2.7	0.106	0.1	●		●	●	3	9.525	3.18
GLR/L4115	1.15	0.045	0.1	●		●		1.5	12.7	4.76
GLR/L4135	1.35	0.053	0.1	●		●		1.5	12.7	4.76
GLR/L4165	1.65	0.065	0.1	●		●		2	12.7	4.76
GLR/L4175	1.75	0.069	0.1	●		●		2	12.7	4.76
GLR/L4190	1.9	0.075	0.1	●				2.5	12.7	4.76
GLR/L4195	1.95	0.077	0.1	●		●		2.5	12.7	4.76
GLR/L4220	2.2	0.087	0.1	●		●	●	3.5	12.7	4.76
GLR/L4270	2.7	0.106	0.1	●		●		3.5	12.7	4.76
GLR/L4320	3.2	0.126	0.1	●		●	●	4	12.7	4.76
GLR/L4420	4.2	0.165	0.1	●		●	●	4	12.7	4.76

● : Line up

STANDARD CUTTING CONDITIONS

ISO	Workpiece material	Grade	Cutting speed V_c (sfm)	Feed f (ipr)		
				$W < 0.078''$	$W = 0.078'' - 0.157''$	$W > 0.157''$
P	Carbon steels	NS9530	260 - 650	0.002 - 0.004	0.003 - 0.008	0.003 - 0.010
		UX30	200 - 500	0.002 - 0.004	0.003 - 0.008	0.003 - 0.010



GTGN

CER/L

External grooving toolholders, alternative clamping of screw-on or clamp-on(DT type only)

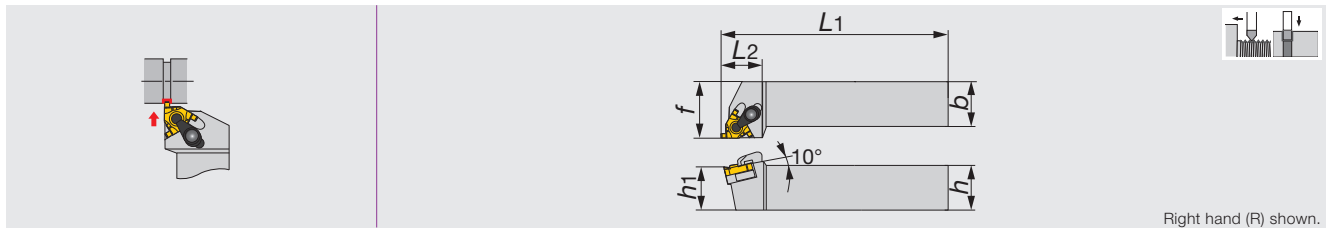

Right hand (R) shown.

Inch	<i>h</i>	<i>b</i>	<i>L1</i>	<i>L2</i>	<i>h1</i>	<i>f</i>	Insert
CER/L123DT	0.750	0.750	5.000	0.870	0.750	1.000	GTGN16...
CER/L163DT	1.000	1.000	6.000	1.000	1.000	1.250	GTGN16...
CER203DT	1.250	1.250	6.000	1.250	1.250	1.500	GTGN16...

Metric	<i>h</i>	<i>b</i>	<i>L1</i>	<i>L2</i>	<i>h1</i>	<i>f</i>	Insert
CER/L1212H16DT	12	12	100	24	12	16	GTGN16...
CER/L1616H16DT	16	16	100	24	16	20	GTGN16...
CER/L2020K16DT	20	20	125	24	20	25	GTGN16...
CER/L2525M16DT	25	25	150	28	25	32	GTGN16...
CER3232P16T	32	32	170	32	32	40	GTGN16...

- A clamp set for CER/L type consists of a clamp and a clamping screw. • A shim set for CER/L type consists of a shim and a shim screw.
- Standard shims for CER/L type can be used for both left hand and right hand toolholders. Use either of the sides depending on the hand.
- When using the GTGN insert, the exclusive shim must be used. Exclusive shim should be ordered separately.

SPARE PARTS

Designation	Clamp set	Clamping screw	Shim screw	Shim (Optional parts)	Wrench	Wrench 1
CER/L123DT, CER/L163DT, CER203DT	CSP16	CSTB-3.5ST	DTS5-3.5	(G16ER/IL-DT)	P-3.5	T-15F
CER*****16DT	CSP16	CSTB-3.5ST	DTS5-3.5	(G16ER/IL-DT)	P-3.5	T-15F
CEL*****16DT	CSP16	CSTB-3.5ST	DTS5-3.5	(G16EL/IR-DT)	P-3.5	T-15F
CER3232P16T	CSP16	-	-	(G16ER/IR-S)	-	T-15F



B-S/CER/L

External threading toolholders for swiss lathes

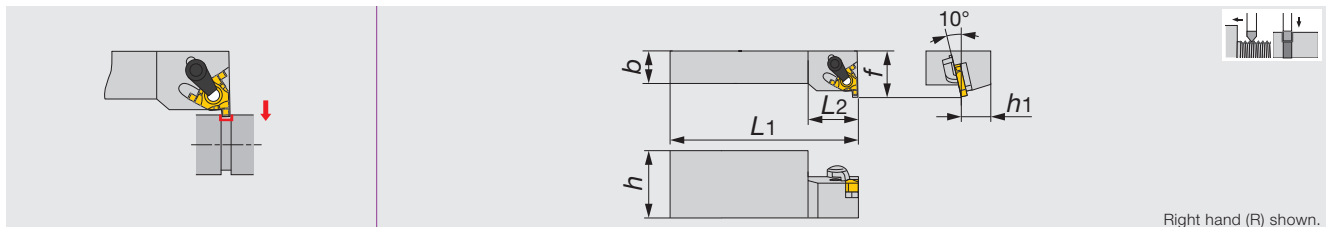

Right hand (R) shown.

Metric	<i>h</i>	<i>b</i>	<i>L1</i>	<i>L2</i>	<i>h1</i>	<i>f</i>	Insert
B-CER/L16M16	32	16	150	24	16	22	GTGN16...

- When using the GTGN insert, the exclusive shim must be used. Exclusive shim should be ordered separately.

SPARE PARTS

Designation	Clamp set	Clamping screw	Wrench	Shim (Optional parts)
B-CER16M16	CSP16	-	T-15F	(G16ER/IL-S)
B-CEL16M16	CSP16	-	T-15F	(G16EL/IR-S)

Reference pages

Inserts → C045, Standard cutting conditions → C046

CNR

Internal grooving bars, alternative clamping of screw-on or clamp-on (DT type only)

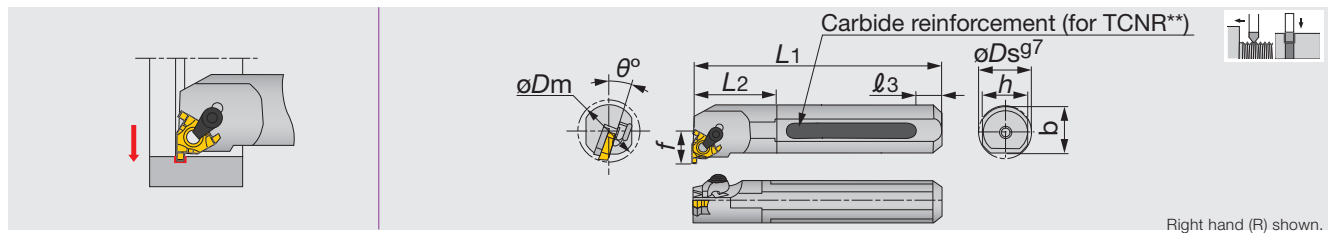

Inch	Material	ϕD_m	ϕD_s	f	L_1	L_2	ℓ_3	h	b	θ°	Insert
S12-CNR3DT	STEEL	0.950	0.750	0.552	7.000	1.200	-	0.725	0.738	15	GTGN-16...
S16-CNR3DT	STEEL	1.150	1.000	0.652	8.000	1.500	-	0.906	0.953	15	GTGN-16...
S20-CNR3DT	STEEL	1.450	1.250	0.788	10.000	1.900	-	1.188	1.219	15	GTGN-16...

- Shim is used for both right and left hand toolholders.
- A clamp set for CNR/L type toolholders consists of a clamp and a clamping screw. • A shim set for CNR/L type toolholders consists of a shim and a shim fixing screw.
- Standard shims for CNR/L type toolholders are commonly used for right and left hand toolholders.
- When using the GTGN insert, the exclusive shim must be used. Exclusive shim should be ordered separately.

SPARE PARTS						
Designation	Clamp set	Clamping screw	Shim screw	Shim (Optional parts)	Wrench	Wrench 1
S**-CNR3DT	CSP16	CSTB-3.5ST	DTS5-3.5	(G16EL/IR-DT)	P-3.5	T-15F

INSERT

GTGN16

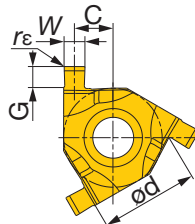

Right hand (R) shown.

Designation	$W_{\pm 0.03}$ (mm)	$W_{\pm 0.001}$ (in)	r_ϵ (in)	SH730	Insert size	ϕd (in)	G (in)	C (in)	Shim	
									Dual method clamp type; Screw-on/ Clamp-on	Clamp-on type
GTGN-16ER/IL100	1	0.039	0.004	●	16	0.375	0.049	0.166	G16ER/IL-DT	G16ER/IL-S
GTGN-16ER/IL120	1.2	0.047	0.004	●	16	0.375	0.051	0.162	G16ER/IL-DT	G16ER/IL-S
GTGN-16ER/IL140	1.4	0.055	0.004	●	16	0.375	0.059	0.158	G16ER/IL-DT	G16ER/IL-S
GTGN-16ER/IL170	1.7	0.067	0.004	●	16	0.375	0.067	0.152	G16ER/IL-DT	G16ER/IL-S
GTGN-16ER/IL195	1.95	0.077	0.004	●	16	0.375	0.067	0.148	G16ER/IL-DT	G16ER/IL-S
GTGN-16ER/IL225	2.25	0.089	0.004	●	16	0.375	0.071	0.142	G16ER/IL-DT	G16ER/IL-S
GTGN-16EL/IR100	1	0.039	0.004	●	16	0.375	0.049	0.166	G16EL/IR-DT	G16EL/IR-S
GTGN-16EL/IR120	1.2	0.047	0.004	●	16	0.375	0.051	0.162	G16EL/IR-DT	G16EL/IR-S
GTGN-16EL/IR140	1.4	0.055	0.004	●	16	0.375	0.059	0.158	G16EL/IR-DT	G16EL/IR-S
GTGN-16EL/IR170	1.7	0.067	0.004	●	16	0.375	0.067	0.152	G16EL/IR-DT	G16EL/IR-S
GTGN-16EL/IR195	1.95	0.077	0.004	●	16	0.375	0.067	0.148	G16EL/IR-DT	G16EL/IR-S
GTGN-16EL/IR225	2.25	0.089	0.004	●	16	0.375	0.071	0.142	G16EL/IR-DT	G16EL/IR-S

Note:
GTGN insert is applicable for both external and internal grooving, but the hand of tool is opposite in external and internal machining.
Shim for GTGN is exclusive to each type of toolholders

Package quantity = 10 pcs

● : Line up

Reference pages

Standard cutting conditions → C046

Tungaloy C045



STANDARD CUTTING CONDITIONS

ISO	Workpiece material	Grade	Cutting speed Vc (sfm)	Feed f (ipr)
P	Steels 1045, 4140, etc.	SH730	160 - 490	0.002 - 0.004
M	Stainless steels 304, 316, etc.	SH730	100 - 490	0.002 - 0.004
S	Heat-resistant alloys, Titanium alloys etc. Ti-6Al-4V, etc.	SH730	100 - 330	0.002 - 0.004

Multi-purpose grooving line with economical insert containing 4 cutting edges

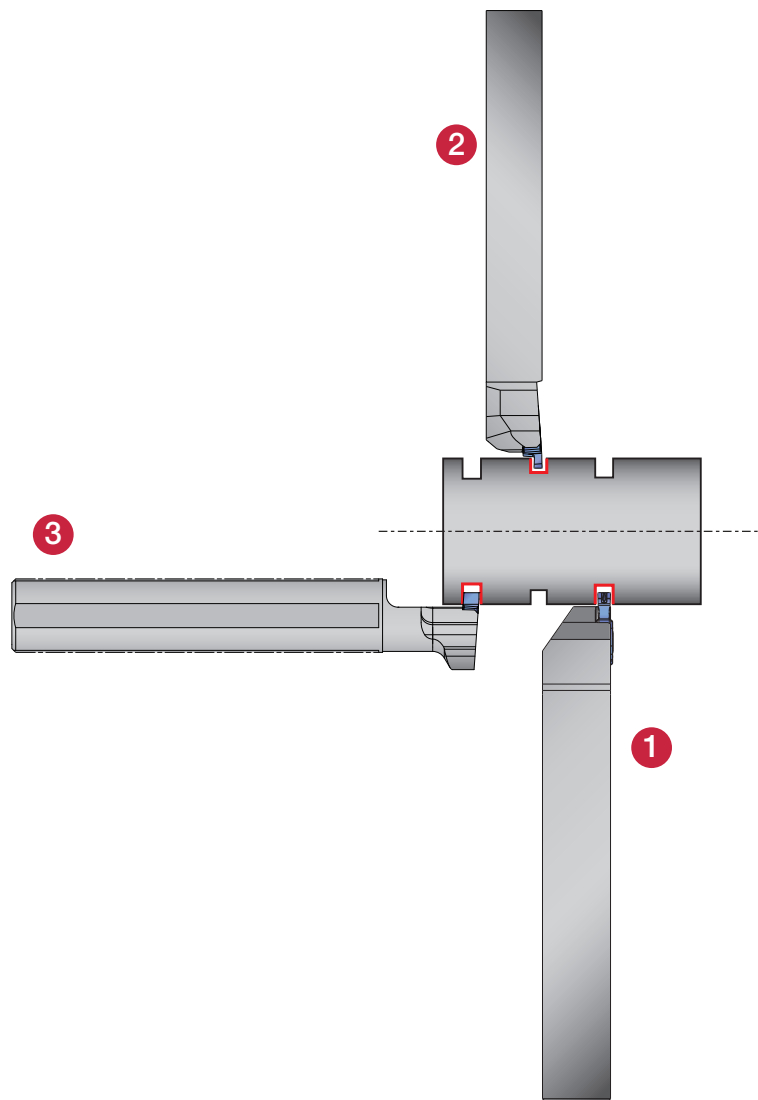

Grooving Tool

TETRAFCUT



External



Parting-off

Others

1 STCR/L -27

$W = 0.020'' - 0.125''$
(0.5 - 3.18 mm)
 $ar = 0.039'' - 0.252''$
(1.0 - 6.4 mm)
Shank size:
0.375'' - 1.000'' (10 - 25 mm)

Page C048

STCR/L -27-CHP

$W = 0.020'' - 0.125''$
(0.5 - 3.18 mm)
 $ar = 0.039'' - 0.252''$
(1.0 - 6.4 mm)
Shank size: 1.000'' (25 mm)

Page C048

2 STCR/L -18

$W = 0.013'' - 0.118''$
(0.33 - 3 mm)
 $ar = 0.031'' - 0.098''$
(0.8 - 2.5 mm)
Shank size:
0.375'' - 1.000'' (10 - 25 mm)

Page C055

3 JS-STCR/L18

$W = 0.013'' - 0.118''$
(0.33 - 3 mm)
 $ar = 0.031'' - 0.098''$
(0.8 - 2.5 mm)
Shank size:
0.551'' - 1.000'' (14 - 25.4 mm)

Page C056

JS-STCR/L27

$W = 0.020'' - 0.125''$
(0.5 - 3.18 mm)
 $ar = 0.039'' - 0.252''$
(1.0 - 6.4 mm)
Shank size:
0.750'' - 1.000'' (19.05 - 25.4 mm)

Page C049



TETRAFCUT

STCR/L-27

Precision external grooving tools with uniquely shaped insert with 4 cutting edges

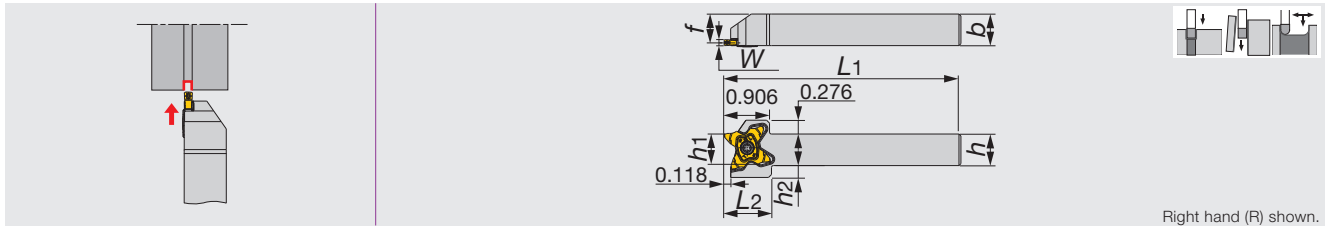

Inch	W	h1	b	h	L1	f	h2	L2	Insert
STCR/L06-27	0.020 - 0.125	0.375	0.375	0.375	5.000	0.315	0.374	0.945	TC*27...
STCR/L08-27	0.020 - 0.125	0.500	0.500	0.500	5.000	0.440	0.287	0.945	TC*27...
STCR/L10-27	0.020 - 0.125	0.625	0.625	0.625	5.000	0.570	0.236	0.945	TC*27...
STCR/L12-27	0.020 - 0.125	0.750	0.750	0.750	5.000	0.690	0.118	0.945	TC*27...
STCR/L16-27	0.020 - 0.125	1.000	1.000	1.000	5.500	0.940	-	-	TC*27...

SPARE PARTS

Designation	Screw	Wrench
STCR...	SR16-212-01397L	T-2010/5
STCL...	SR16-212-01397	T-2010/5

STCR/L-CHP

Precision external grooving tools with uniquely shaped insert, with channels for high pressure coolant.

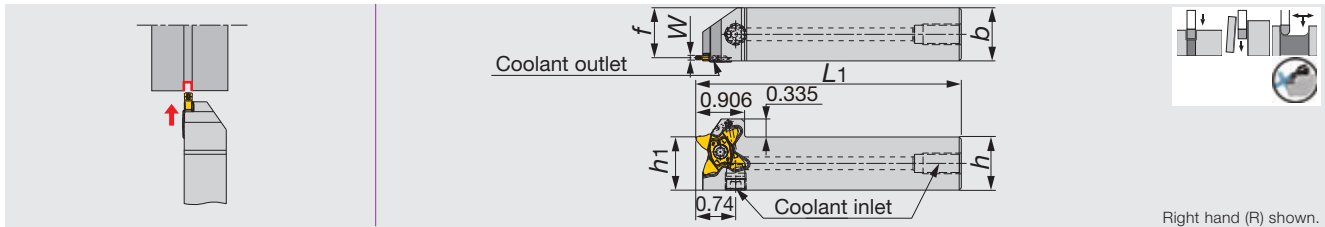

Inch	W	h1	b	h	L1	f	Insert
STCR/L16-27-CHP	0.020 - 0.125	1.000	1.000	1.000	5.500	0.940	TC*27...

SPARE PARTS

Designation	Screw	Wrench
STCR...-27-CHP	SR16-212-01397L	T-2010/5
STCL...-27-CHP	SR16-212-01397	T-2010/5



Reference pages

Inserts → C050 - C053, Standard cutting conditions → C054

Precision grooving tools with uniquely shaped insert for swiss lathes

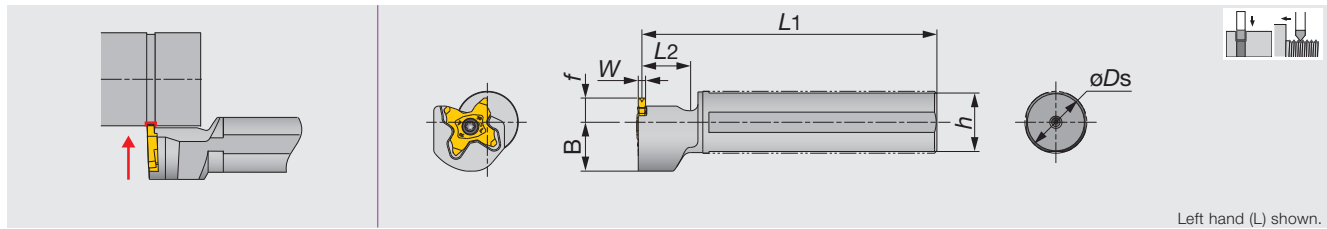

Inch	W	øDs	L1	L2	h	B	f	Insert
JS19X-STCR/L27	0.020 - 0.125	0.750	4.724	0.787	0.551	0.787	0.394	TC*27...
JS254X-STCR/L27	0.020 - 0.125	1.000	4.724	0.787	0.945	0.787	0.394	TC*27...

SPARE PARTS

Designation	Screw	Wrench
JS****-STCR27	SR16-212-01397	T-2010/5
JS****-STCL27	SR16-212-01397L	T-2010/5



Grooving Tool

TETRAFCUT



External

Others

Reference pages

Inserts → C050 - C053, Standard cutting conditions → C054



INSERT - FOR GROOVING AND PARTING OFF

TCS27

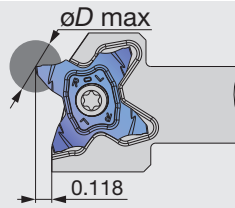
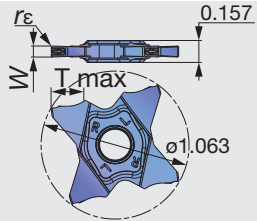

Designation	W ± 0.02 (mm)	W ± 0.001 (in)	rε (in)	AH725	T max (in)	øD max (in)	Relation of groove depth (T) and Max. diameter øD max (in)												
							T≤1	T≤2	T≤3	T≤3.5	T≤4	T≤4.5	T≤5	T≤5.5	T≤5.7	T≤6	T≤6.2	T≤6.4	
TCS27-050-000	0.5	0.020	0.000	●	0.039	0.079	∞	-	-	-	-	-	-	-	-	-	-	-	-
TCS27-050-004	0.5	0.020	0.0016	●	0.098	0.197	∞	∞	-	-	-	-	-	-	-	-	-	-	-
TCS27-075-010	0.75	0.030	0.004	●	0.098	0.197	∞	∞	-	-	-	-	-	-	-	-	-	-	-
TCS27-080-000	0.8	0.031	0.000	●	0.063	0.126	∞	-	-	-	-	-	-	-	-	-	-	-	-
TCS27-100-006	1	0.039	0.0024	●	0.138	0.276	∞	∞	∞	23.622	-	-	-	-	-	-	-	-	-
TCS27-100-010	1	0.039	0.004	●	0.138	0.276	∞	∞	∞	23.622	-	-	-	-	-	-	-	-	-
TCS27-104-000	1.04	0.041	0.000	●	0.079	0.158	∞	∞	-	-	-	-	-	-	-	-	-	-	-
TCS27-120-000	1.2	0.047	0.000	●	0.079	0.158	∞	∞	-	-	-	-	-	-	-	-	-	-	-
TCS27-125-010	1.25	0.049	0.004	●	0.138	0.276	∞	∞	∞	23.622	-	-	-	-	-	-	-	-	-
TCS27-125-020	1.25	0.049	0.008	●	0.138	0.276	∞	∞	∞	23.622	-	-	-	-	-	-	-	-	-
TCS27-140-000	1.4	0.055	0.000	●	0.079	0.158	∞	∞	-	-	-	-	-	-	-	-	-	-	-
TCS27-147-000	1.47	0.058	0.000	●	0.098	0.197	∞	∞	-	-	-	-	-	-	-	-	-	-	-
TCS27-150-010	1.5	0.059	0.004	●	0.224	0.449	∞	∞	∞	23.622	11.024	7.087	5.118	1.969	1.378	-	-	-	-
TCS27-150-020	1.5	0.059	0.008	●	0.224	0.449	∞	∞	∞	23.622	11.024	7.087	5.118	1.969	1.378	-	-	-	-
TCS27-157-015	1.57	0.062	0.006	●	0.118	0.236	∞	∞	∞	-	-	-	-	-	-	-	-	-	-
TCS27-170-010	1.7	0.067	0.004	●	0.118	0.236	∞	∞	∞	-	-	-	-	-	-	-	-	-	-
TCS27-175-010	1.75	0.069	0.004	●	0.118	0.236	∞	∞	∞	-	-	-	-	-	-	-	-	-	-
TCS27-175-020	1.75	0.069	0.008	●	0.118	0.236	∞	∞	∞	-	-	-	-	-	-	-	-	-	-
TCS27-178-018	1.78	0.070	0.007	●	0.118	0.236	∞	∞	∞	-	-	-	-	-	-	-	-	-	-
TCS27-185-020	1.85	0.073	0.008	●	0.118	0.236	∞	∞	∞	-	-	-	-	-	-	-	-	-	-
TCS27-196-015	1.96	0.077	0.006	●	0.118	0.236	∞	∞	∞	-	-	-	-	-	-	-	-	-	-
TCS27-200-010	2	0.079	0.004	●	0.252	0.504	∞	∞	∞	23.622	11.024	7.087	5.118	4.134	3.346	2.362	1.969	1.181	-
TCS27-200-020	2	0.079	0.008	●	0.252	0.504	∞	∞	∞	23.622	11.024	7.087	5.118	4.134	3.346	2.362	1.969	1.181	-
TCS27-222-015	2.22	0.087	0.006	●	0.138	0.276	∞	∞	∞	23.622	-	-	-	-	-	-	-	-	-
TCS27-230-020	2.3	0.091	0.008	●	0.138	0.276	∞	∞	∞	23.622	-	-	-	-	-	-	-	-	-
TCS27-239-015	2.39	0.094	0.006	●	0.224	0.449	∞	∞	∞	23.622	11.024	7.087	5.118	1.969	1.378	-	-	-	-
TCS27-247-020	2.47	0.097	0.008	●	0.224	0.449	∞	∞	∞	23.622	11.024	7.087	5.118	1.969	1.378	-	-	-	-
TCS27-250-010	2.5	0.098	0.004	●	0.224	0.449	∞	∞	∞	23.622	11.024	7.087	5.118	1.969	1.378	-	-	-	-
TCS27-250-030	2.5	0.098	0.012	●	0.224	0.449	∞	∞	∞	23.622	11.024	7.087	5.118	1.969	1.378	-	-	-	-
TCS27-270-010	2.7	0.106	0.004	●	0.244	0.488	∞	∞	∞	23.622	11.024	7.087	5.315	4.134	3.740	3.346	3.071	-	-
TCS27-287-020	2.87	0.113	0.008	●	0.244	0.488	∞	∞	∞	23.622	11.024	7.087	5.315	4.134	3.740	3.346	3.071	-	-
TCS27-300-000	3	0.118	0.000	●	0.252	0.504	∞	∞	∞	23.622	11.024	7.087	5.315	4.134	3.740	3.346	3.071	2.165	-
TCS27-300-020	3	0.118	0.008	●	0.252	0.504	∞	∞	∞	23.622	11.024	7.087	5.315	4.134	3.740	3.346	3.071	2.165	-
TCS27-300-030	3	0.118	0.012	●	0.252	0.504	∞	∞	∞	23.622	11.024	7.087	5.315	4.134	3.740	3.346	3.071	2.165	-
TCS27-300-040	3	0.118	0.016	●	0.252	0.504	∞	∞	∞	23.622	11.024	7.087	5.315	4.134	3.740	3.346	3.071	2.165	-
TCS27-315-015	3.15	0.124	0.006	●	0.252	0.504	∞	∞	∞	23.622	11.024	7.087	5.315	4.134	3.740	3.346	3.071	2.677	-
TCS27-318-020	3.18	0.125	0.008	●	0.252	0.504	∞	∞	∞	23.622	11.024	7.087	5.315	4.134	3.740	3.346	3.071	2.677	-

Package Quantity = 5 pcs.

● : Line up

INSERT - FOR PARTING OFF

TCS27-R/L

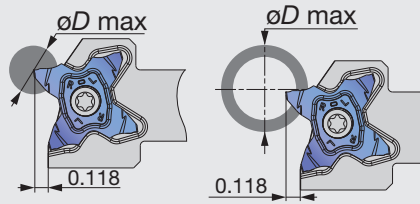
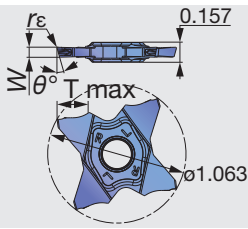

Right hand (R) shown.

Designation	W ± 0.02 (mm)	W ± 0.001 (in)	rε (in)	AH725		T max (in)	θ°	Max. parting off dia. øD max (in)	
				R	L			Solid bar	Tube
TCS27-100-15R/L	1	0.039	0.0024	●	●	0.138	15	0.276	23.622
TCS27-150-6R/L	1.5	0.059	0.0024	●	●	0.224	6	0.449	1.378
TCS27-150-15R/L	1.5	0.059	0.0024	●	●	0.224	15	0.449	1.378
TCS27-200-6R/L	2	0.079	0.004	●	●	0.252	6	0.504	1.181
TCS27-200-15R/L	2	0.079	0.004	●	●	0.252	15	0.504	1.181

Package Quantity = 5 pcs.

● : Line up

INSERT - FOR GROOVING AND PROFILING

TCS27-Full R

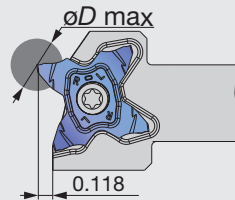
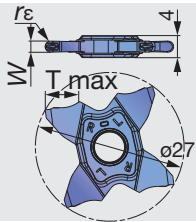

Designation	W ± 0.02 (mm)	W ± 0.001 (in)	rε (in)	AH725	T max (in)	Relation of groove depth (T) and Max. diameter øD max (in)											
						T ≤ 0.039	T ≤ 0.079	T ≤ 0.118	T ≤ 0.138	T ≤ 0.158	T ≤ 0.177	T ≤ 0.197	T ≤ 0.217	T ≤ 0.224	T ≤ 0.236	T ≤ 0.244	T ≤ 0.252
TCS27-157-079	1.57	0.062	0.031	●	0.118	∞	∞	∞	-	-	-	-	-	-	-	-	
TCS27-200-100	2	0.079	0.039	●	0.118	∞	∞	∞	-	-	-	-	-	-	-	-	
TCS27-239-120	2.39	0.094	0.047	●	0.224	∞	∞	∞	23.622	11.024	7.087	5.118	1.969	1.378	-	-	
TCS27-300-150	3	0.118	0.059	●	0.252	∞	∞	∞	23.622	11.024	7.087	5.315	4.134	3.740	3.346	3.071	2.165

Package Quantity = 5 pcs.

● : Line up



Grooving Tool

TETRAFCÜT



INSERT - FOR GROOVING AND PARTING OFF

TCM27

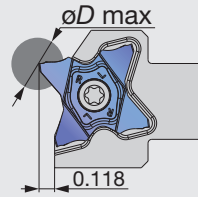
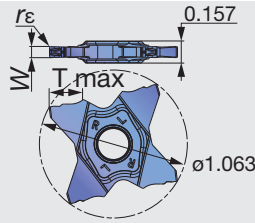

Designation	W ± 0.02 (mm)	W ± 0.001 (in)	rε (in)	AH725	T max (in)	øD max (in)	Relation of groove depth (T) and Max. diameter øD max (in)												
							Ts0.039	Ts0.078	Ts0.118	Ts0.138	Ts0.157	Ts0.177	Ts0.197	Ts0.217	Ts0.224	Ts0.236	Ts0.244	Ts0.252	
TCM27-150-010	1.5	0.059	0.004	●	0.224	0.449	∞	∞	∞	23.622	11.024	7.087	5.118	1.969	1.378	-	-	-	
TCM27-150-020	1.5	0.059	0.008	●	0.224	0.449	∞	∞	∞	23.622	11.024	7.087	5.118	1.969	1.378	-	-	-	
TCM27-157-015	1.57	0.062	0.006	●	0.118	0.236	∞	∞	∞	-	-	-	-	-	-	-	-	-	
TCM27-170-010	1.7	0.067	0.004	●	0.118	0.236	∞	∞	∞	-	-	-	-	-	-	-	-	-	
TCM27-175-010	1.75	0.069	0.004	●	0.118	0.236	∞	∞	∞	-	-	-	-	-	-	-	-	-	
TCM27-175-020	1.75	0.069	0.008	●	0.118	0.236	∞	∞	∞	-	-	-	-	-	-	-	-	-	
TCM27-178-018	1.78	0.07	0.007	●	0.118	0.236	∞	∞	∞	-	-	-	-	-	-	-	-	-	
TCM27-185-020	1.85	0.073	0.008	●	0.118	0.236	∞	∞	∞	-	-	-	-	-	-	-	-	-	
TCM27-196-015	1.96	0.077	0.006	●	0.118	0.236	∞	∞	∞	-	-	-	-	-	-	-	-	-	
TCM27-200-010	2	0.079	0.004	●	0.252	0.504	∞	∞	∞	23.622	11.024	7.087	5.118	4.134	3.346	2.362	1.969	1.181	
TCM27-200-020	2	0.079	0.008	●	0.252	0.504	∞	∞	∞	23.622	11.024	7.087	5.118	4.134	3.346	2.362	1.969	1.181	
TCM27-222-015	2.22	0.087	0.006	●	0.138	0.276	∞	∞	∞	23.622	-	-	-	-	-	-	-	-	
TCM27-230-020	2.3	0.091	0.008	●	0.138	0.276	∞	∞	∞	23.622	-	-	-	-	-	-	-	-	
TCM27-239-015	2.39	0.094	0.006	●	0.224	0.449	∞	∞	∞	23.622	11.024	7.087	5.118	1.969	1.378	-	-	-	
TCM27-247-020	2.47	0.097	0.008	●	0.224	0.449	∞	∞	∞	23.622	11.024	7.087	5.118	1.969	1.378	-	-	-	
TCM27-250-010	2.5	0.098	0.004	●	0.224	0.449	∞	∞	∞	23.622	11.024	7.087	5.118	1.969	1.378	-	-	-	
TCM27-250-030	2.5	0.098	0.012	●	0.224	0.449	∞	∞	∞	23.622	11.024	7.087	5.118	1.969	1.378	-	-	-	
TCM27-270-010	2.7	0.106	0.004	●	0.244	0.488	∞	∞	∞	23.622	11.024	7.087	5.315	4.134	3.74	3.346	3.071	-	
TCM27-287-020	2.87	0.113	0.008	●	0.244	0.488	∞	∞	∞	23.622	11.024	7.087	5.315	4.134	3.74	3.346	3.071	-	
TCM27-300-000	3	0.118	0	●	0.252	0.504	∞	∞	∞	23.622	11.024	7.087	5.315	4.134	3.74	3.346	3.071	2.165	
TCM27-300-020	3	0.118	0.008	●	0.252	0.504	∞	∞	∞	23.622	11.024	7.087	5.315	4.134	3.74	3.346	3.071	2.165	
TCM27-300-030	3	0.118	0.012	●	0.252	0.504	∞	∞	∞	23.622	11.024	7.087	5.315	4.134	3.74	3.346	3.071	2.165	
TCM27-300-040	3	0.118	0.016	●	0.252	0.504	∞	∞	∞	23.622	11.024	7.087	5.315	4.134	3.74	3.346	3.071	2.165	
TCM27-315-015	3.15	0.124	0.006	●	0.252	0.504	∞	∞	∞	23.622	11.024	7.087	5.315	4.134	3.74	3.346	3.071	2.677	
TCM27-318-020	3.18	0.125	0.008	●	0.252	0.504	∞	∞	∞	23.622	11.024	7.087	5.315	4.134	3.74	3.346	3.071	2.677	

Package Quantity = 5 pcs.

● : Line up

INSERT - FOR GROOVING AND PROFILING

TCM27-Full R

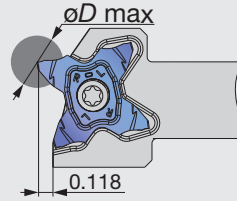
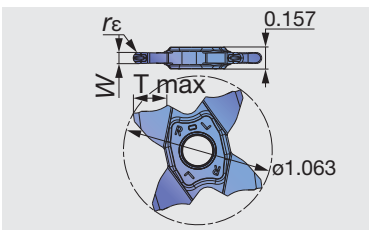

Designation	W ± 0.02 (mm)	W ± 0.001 (in)	rε (in)	AH725	T max (in)	Relation of groove depth (T) and Max. diameter øD max (in)											
						T≤0.039	T≤0.078	T≤0.118	T≤0.138	T≤0.157	T≤0.177	T≤0.197	T≤0.217	T≤0.224	T≤0.236	T≤0.244	T≤0.252
TCM27-157-079	1.57	0.062	0.031	●	0.118	∞	∞	∞	-	-	-	-	-	-	-	-	-
TCM27-200-100	2	0.079	0.039	●	0.118	∞	∞	∞	-	-	-	-	-	-	-	-	-
TCM27-239-120	2.39	0.094	0.047	●	0.224	∞	∞	∞	23.622	11.024	7.087	5.118	1.969	1.378	-	-	-
TCM27-300-150	3	0.118	0.059	●	0.252	∞	∞	∞	23.622	11.024	7.087	5.315	4.134	3.74	3.346	3.071	2.165

Package Quantity = 5 pcs.
● : Line up

CHIPBREAKER

TCS27



W = 0.059" - 0.125"
(0.5 mm - 3.18 mm)

For general machining
Lower cutting force and superior sharpness

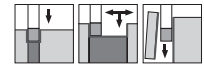

TCM27

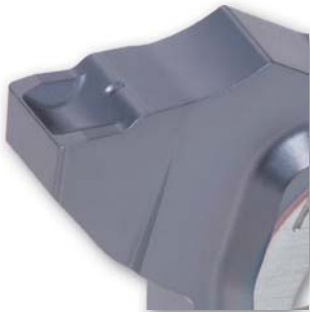

W = 0.059" - 0.125"
(1.5 mm - 3.18 mm)

For high feed machining
Well-designed edge with high strength





STANDARD CUTTING CONDITIONS

ISO	Workpiece material	Grade	Cutting speed V_c (sfm)	Feed: f (ipr)					Depth of cut for profiling (with full radius insert)
				Grooving, parting-off		Parting-off (with hand)	Profiling (with full radius insert)		
				TCS	TCM	TCS	TCS	TCM	
P	Steel (1045, etc.)	AH725	330 - 660	0.002 - 0.006	0.002 - 0.01	0.002 - 0.005	0.002 - 0.004	0.002 - 0.006	0.02
	Alloy steel (4137, etc.)	AH725	165 - 590	0.002 - 0.006	0.002 - 0.01	0.002 - 0.005	0.002 - 0.004	0.002 - 0.006	0.02
M	Stainless steel (304, etc.)	AH725	165 - 490	0.002 - 0.006	0.002 - 0.008	0.002 - 0.005	0.002 - 0.004	0.002 - 0.006	0.02
K	Gray cast iron (No.250, etc.)	AH725	165 - 590	0.002 - 0.006	0.002 - 0.01	0.002 - 0.005	0.002 - 0.004	0.002 - 0.006	0.02
	Ductile cast iron (60-40-18, etc.)	AH725	165 - 390	0.002 - 0.006	0.002 - 0.008	0.002 - 0.005	0.002 - 0.004	0.002 - 0.006	0.02
S	Titanium alloys (Ti-6Al-4V, etc.)	AH725	100 - 200	0.002 - 0.006	0.002 - 0.006	0.002 - 0.005	0.002 - 0.004	0.002 - 0.006	0.02

PARTS FOR COOLANT HOSE

Connecting hose

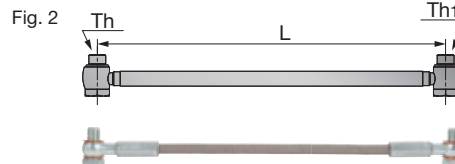
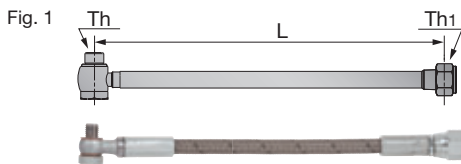

Metric	Length	Threading size		Max. pressure (MPa)	Fig.
	L	Th	Th1		
CHP-HOSE-G1/8-7/16-200BS	200	G1/8"-28 BSPP	7/16"-20 UNF	26	1
CHP-HOSE-G1/8-7/16-250BS	250	G1/8"-28 BSPP	7/16"-20 UNF	26	1
CHP-HOSE-G1/8-G1/8-200BB	200	G1/8"-28 BSPP	G1/8"-28 BSPP	26	2
CHP-HOSE-G1/8-G1/8-250BB	250	G1/8"-28 BSPP	G1/8"-28 BSPP	26	2

Connector

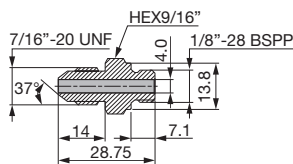

Metric
CHP-NIPPLE-G1/8-7/16UNF

Seal washer

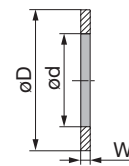

Metric	øD	ød	W
CHP-COPPER-SEAL1/8	15	10	1

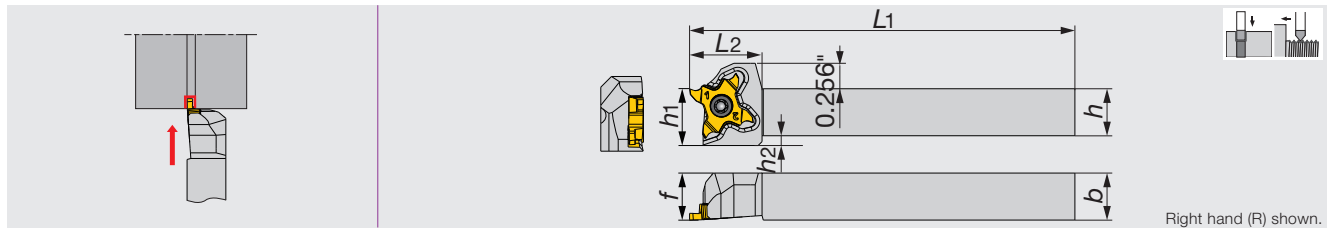

Inch	<i>h</i>	<i>b</i>	<i>L1</i>	<i>L2</i>	<i>h1</i>	<i>f</i>	<i>h2</i>	Insert
STCR/L06-18	0.375	0.375	4.750	0.740	0.375	0.375	0.177	TC*18...
STCR/L08-18	0.500	0.500	4.750	0.740	0.500	0.500	0.098	TC*18...
STCR/L10-18	0.625	0.625	4.750	0.740	0.625	0.625	-	TC*18...
STCR/L12-18	0.750	0.750	4.750	0.900	0.750	1.000	-	TC*18...
STCR/L16-18	1.000	1.000	5.500	0.900	1.000	1.250	-	TC*18...

• The right hand insert (TC*18R***) is used for the right hand toolholders (STCR***), and the left hand insert (TC*18L***) is used for the left hand toolholders (STCL***).

SPARE PARTS



Designation	Clamping screw	Wrench
STCR*****18	CSTC-4L100DL	T-1008/5
STCL*****18	CSTC-4L100DR	T-1008/5



Grooving Tool

TETRAMCUT



External

Others

Reference pages

Inserts → C056 - C058, Standard cutting conditions → C057 - C058



TETRAMCUT

JS-STCR/L18

Precision grooving tools with uniquely shaped insert for swiss lathes

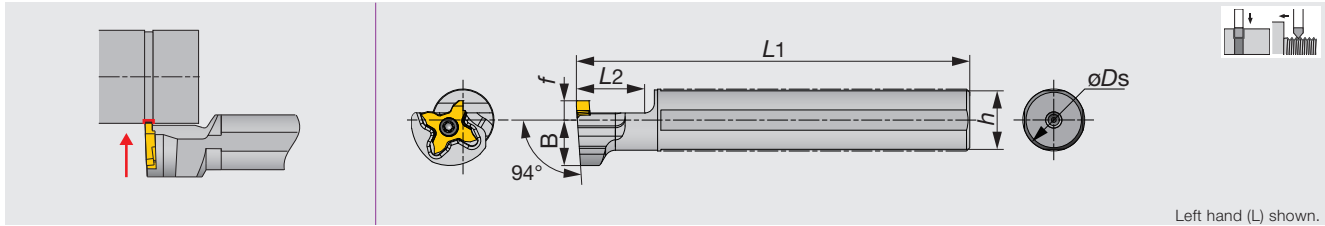

Metric	øDs	L1	L2	h	B	f	Insert
JS14H-STCL18	14	100	20	13	14	6	TC*18...
JS159F-STCL18	15.875 (0.675")	85	20	15	14	6	TC*18...
JS16F-STCL18	16	85	20	15	14	6	TC*18...
JS19G-STCR/L18	19.05 (0.750")	90	20	18	14	6	TC*18...
JS19X-STCL18	19.05 (0.750")	120	20	18	14	6	TC*18...
JS20G-STCL18	20	90	20	19	14	6	TC*18...
JS20X-STCL18	20	120	20	19	14	6	TC*18...
JS22X-STCL18	22	120	20	21	12.25	10	TC*18...
JS25H-STCL18	25	100	20	24	12.25	10	TC*18...
JS254G-STCR18	25.4 (1.00")	90	20	24	12.25	10	TC*18...
JS254X-STCL18	25.4 (1.00")	120	20	24	12.25	10	TC*18...

• The right hand insert (TC*18R**) is used for the left hand toolholders (STCL**), and the left hand insert (TC*18L**) is used for the right hand toolholders (STCR**).

SPARE PARTS

Designation	Clamping screw	Wrench
JS****-STCR18	CSTC-4L100DR	T-1008/5
JS****-STCL18	CSTC-4L100DL	T-1008/5

INSERT

TCP18R/L-F (sharp edge)

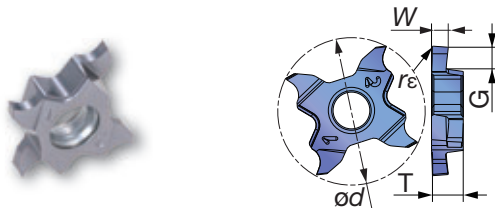

Designation	W±0.02 (mm)	W±0.001 (in)	rε (in)	SH725		G (in)	T (in)	ød (in)
				R	L			
TCP18R/L033F-005	0.33	0.013	0.002	●	●	0.031	0.157	0.709
TCP18R/L043F-005	0.43	0.017	0.002	●	●	0.047	0.157	0.709
TCP18R/L050F-005	0.5	0.020	0.002	●	●	0.047	0.157	0.709
TCP18R/L075F-005	0.75	0.030	0.002	●	●	0.079	0.157	0.709
TCP18R/L095F-005	0.95	0.037	0.002	●	●	0.047	0.157	0.709
TCP18R/L100F-010	1	0.039	0.004	●	●	0.079	0.157	0.709
TCP18R/L120F-010	1.2	0.047	0.004	●	●	0.047	0.157	0.709
TCP18R/L125F-010	1.25	0.049	0.004	●	●	0.079	0.157	0.709
TCP18R/L145F-010	1.45	0.057	0.004	●	●	0.047	0.157	0.709
TCP18R/L150F-010	1.5	0.059	0.004	●	●	0.079	0.157	0.709
TCP18R/L175F-010	1.75	0.069	0.004	●	●	0.047	0.157	0.709
TCP18R/L200F-010	2	0.079	0.004	●	●	0.098	0.157	0.709
TCP18R/L250F-010	2.5	0.098	0.004	●	●	0.098	0.157	0.709
TCP18R/L300F-010	3	0.118	0.004	●	●	0.098	0.157	0.709

● : Line up

Reference pages

Inserts → C056 - C058, Standard cutting conditions → C057 - C058

TCP18R/L(honed edge)

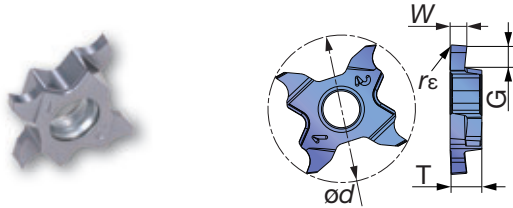

Designation	W±0.02 (mm)	W±0.001 (in)	rε (in)	AH725		G (in)	T (in)	ød (in)
				R	L			
TCP18R/L033-005	0.33	0.013	0.002	●	●	0.031	0.157	0.709
TCP18R/L043-005	0.43	0.017	0.002	●	●	0.047	0.157	0.709
TCP18R/L050-005	0.5	0.020	0.002	●	●	0.047	0.157	0.709
TCP18R/L075-005	0.75	0.030	0.002	●	●	0.079	0.157	0.709
TCP18R/L095-005	0.95	0.037	0.002	●	●	0.079	0.157	0.709
TCP18R/L100-010	1	0.039	0.004	●	●	0.079	0.157	0.709
TCP18R/L120-010	1.2	0.047	0.004	●	●	0.079	0.157	0.709
TCP18R/L125-010	1.25	0.049	0.004	●	●	0.079	0.157	0.709
TCP18R/L145-010	1.45	0.057	0.004	●	●	0.079	0.157	0.709
TCP18R/L150-010	1.5	0.059	0.004	●	●	0.079	0.157	0.709
TCP18R/L175-010	1.75	0.069	0.004	●	●	0.079	0.157	0.709
TCP18R/L200-010	2	0.079	0.004	●	●	0.098	0.157	0.709
TCP18R/L250-010	2.5	0.098	0.004	●	●	0.098	0.157	0.709
TCP18R/L300-010	3	0.118	0.004	●	●	0.098	0.157	0.709

● : Line up

STANDARD CUTTING CONDITIONS

ISO	Workpiece material	Priority	Grade	Cutting speed Vc (sfm)	Feed f (ipr)
P	Low carbon steels (1015, etc.)	First choice	SH725	260 - 590	0.001 - 0.004
		Toughness	AH725	260 - 590	0.001 - 0.004
	Carbon steels, Alloy steels (1055, etc.)	First choice	SH725	260 - 590	0.001 - 0.004
		Toughness	AH725	260 - 590	0.001 - 0.004
M	Prehardened steels (NAK80, PX5 etc.)	First choice	SH725	260 - 590	0.001 - 0.004
		Toughness	AH725	260 - 590	0.001 - 0.004
	Stainless steels (S30400, etc)	First choice	SH725	160 - 394	0.001 - 0.004
		Toughness	AH725	160 - 394	0.001 - 0.004
K	Grey cast irons (No.250B, No.300B etc.)	First choice	AH725	160 - 590	0.001 - 0.004
		Sharpness	SH725	160 - 590	0.001 - 0.004
	Ductile cast irons (60-40-18, 80-55-06, etc.)	First choice	AH725	160 - 590	0.001 - 0.004
		Sharpness	SH725	160 - 590	0.001 - 0.004
S	Titanium alloys (Ti-6Al-4V, etc.)	First choice	SH725	60 - 260	0.001 - 0.004
		Toughness	AH725	60 - 260	0.001 - 0.004
	Superalloys (Inconel718, etc.)	First choice	SH725	60 - 260	0.001 - 0.004
		Toughness	AH725	60 - 260	0.001 - 0.004

CHIPBREAKER

TCP18



W = 0.013" - 0.118"
(0.33 mm - 3 mm)

Suitable for small parts on swiss lathe
Low cutting force with large rake angle

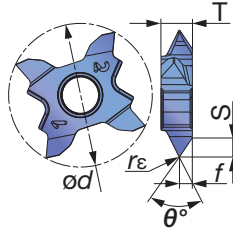

**INSERT****TCT18R/L (For Threading)**

Designation	rε (in)	AH725		Pitch min (in)	Pitch max (in)	f (in)	S (in)	θ°	T (in)	ød (in)
		R	L							
TCT18R/L-60N-010	0.004	●	●	0.031 (0.8 mm)	0.118 (3 mm)	0.063	0.105	60	0.157	0.709
TCT18R/L-60N-020	0.008	●	●	0.059 (1.5 mm)	0.118 (3 mm)	0.063	0.101	60	0.157	0.709

● : Line up

STANDARD CUTTING CONDITIONS

ISO	Workpiece material	Grade	Cutting speed Vc (sfm)	Pitch (in)	TPI
P	Low carbon steels (1015, etc.)	AH725	190 - 490	0.031 - 0.118	32 - 8
	Carbon steels, Alloy steels (1055, etc.)	AH725	190 - 490	0.031 - 0.118	32 - 8
	Prehardened steels (NAK80, PX5 etc.)	AH725	190 - 490	0.031 - 0.118	32 - 8
M	Stainless steels (S30400, etc)	AH725	160 - 260	0.031 - 0.118	32 - 8
K	Grey cast irons (No.250B, No.300B etc.)	AH725	160 - 320	0.031 - 0.118	32 - 8
	Ductile cast irons (60-40-18, 80-55-06, etc.)	AH725	160 - 320	0.031 - 0.118	32 - 8
S	Titanium alloys (Ti-6Al-4V, etc.)	AH725	90 - 320	0.031 - 0.118	32 - 8
	Superalloys (Inconel718, etc.)	AH725	90 - 320	0.031 - 0.118	32 - 8

Multi-functional tool reduces tool cost and shortens set-up time

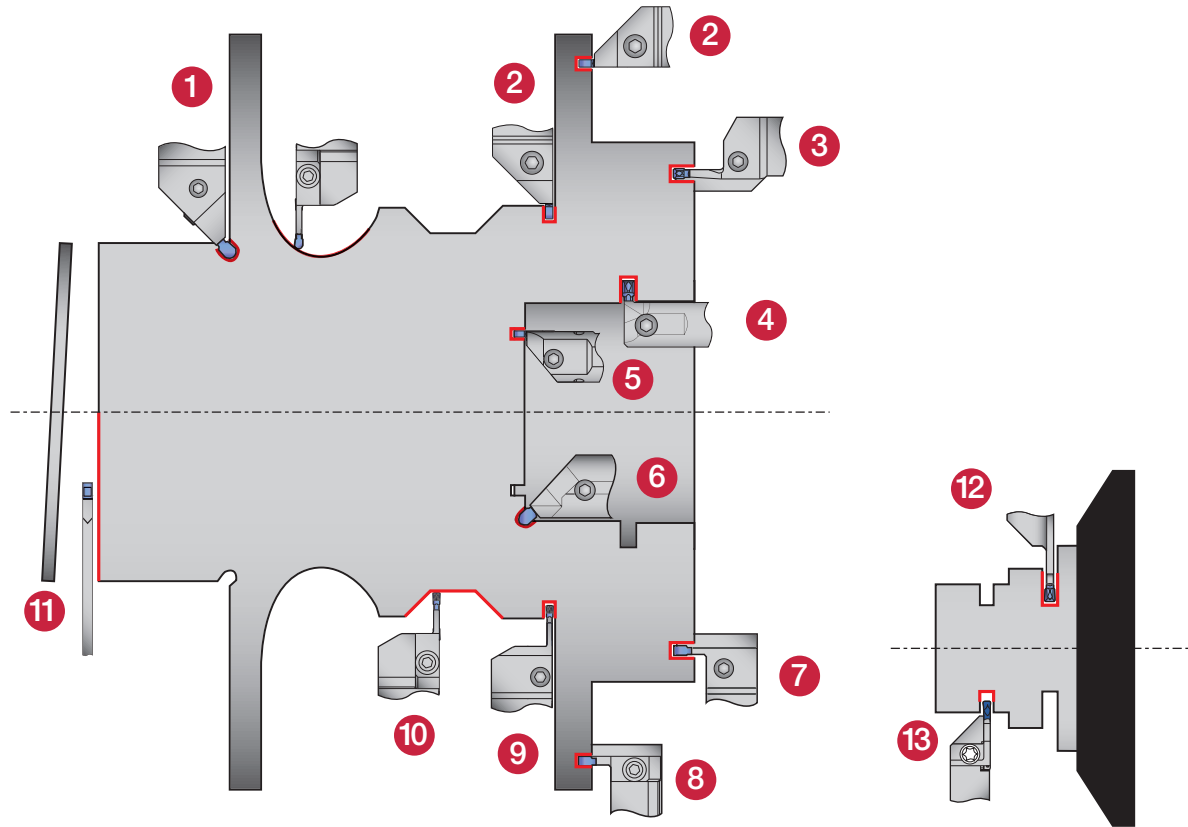

Others

1 CGEUR/L
 Monoblock type
 $W = 0.118'' - 0.236''$
 (3 - 6 mm)
 $ar = 0.110'' - 0.314''$
 (2.8 - 3.4 mm)
 Shank size: 16 - 25 mm
 Page C069

2 CTEFR/L
 Monoblock type
 $W = 0.157'' - 0.236''$
 (2 - 6 mm)
 $ar = 0.189''$
 (4.8 mm)
 Shank size: 0.75'' - 1.00''
 (20 - 25 mm)
 Page C063

3 CTFR/L
 Monoblock type
 $W = 0.118'' - 0.236''$
 (3 - 6 mm)
 $ar = 10 - 25$ mm
 Shank size: 25 mm
 Page C072

4 CTIR/L
 Monoblock type
 $W = 0.079'' - 0.315''$
 (2 - 8 mm)
 $ar = 0.157'' - 0.394''$
 (4 - 10 mm)
 Shank size:
 0.750'' - 1.500''
 (16 - 40 mm)
 Page C070

5 CTIFR/L
 Monoblock type
 $W = 0.118'' - 0.236''$
 (3 - 6 mm)
 $ar = 0.217''$ (5.5 mm)
 Shank size:
 1.000'' - 1.250''
 (25 - 32 mm)
 Page C077

6 CGIUR/L
 Monoblock type
 $W = 0.118'' - 0.236''$
 (3 - 6 mm)
 $ar = 0.110''$ (2.8 mm)
 Shank size: 20 - 25 mm
 Page C071

7 CTFVR/L
 Monoblock type
 $W = 3 - 6$ mm
 $ar = 10 - 20$ mm
 Shank size: 25 mm
 Page C073

8 CAFR/L
 Adaptor type
 $W = 0.118'' - 0.236''$
 (3 - 6 mm)
 $ar = 0.472'' - 0.984''$
 (12 - 25 mm)
 Shank size:
 0.75'' - 1.25''
 (20 - 32 mm)
 Page C074

9 CTER/L
 Monoblock type
 $W = 0.079'' - 0.315''$
 (2 - 8 mm)
 $ar = 0.315'' - 1.417''$
 (8 - 36 mm)
 Shank size:
 0.625'' - 1.250''
 (16 - 32 mm)
 Page C060

10 CAER/L
 Adaptor type
 $W = 0.118'' - 0.236''$
 (3 - 6 mm)
 $ar = 0.630'' - 0.787''$
 (16 - 20 mm)
 Shank size:
 0.75'' - 1.25''
 (20 - 32 mm)
 Page C064

11 CGP
 Blade type
 $W = 0.055'' - 0.315''$
 (1.4 - 8 mm)
 Max. parting Dia.:
 4.724'' (ø120 mm)
 Shank size:
 1.000'' - 1.26''
 (20 - 25 mm)
 Page C067

12 CGER/L
 Monoblock type
 $W = 0.055'' - 0.157''$
 (1.4 - 4 mm)
 $ar = 0.382'' - 0.799''$
 (9.7 - 20.3 mm)
 Shank size: 12 - 20 mm
 Page C063

13 JCTER/L
 Monoblock type
 $W = 0.055'' - 0.118''$
 (1.4 - 3 mm)
 $ar = 0.50'' - 0.625''$
 (10 - 16 mm)
 Shank size:
 0.500'' - 0.625''
 (10 - 20 mm)
 Page C062



Grooving Tool

TUNG CUT

CTER/L

External toolholders for grooving, parting & turning

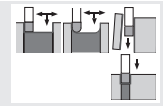
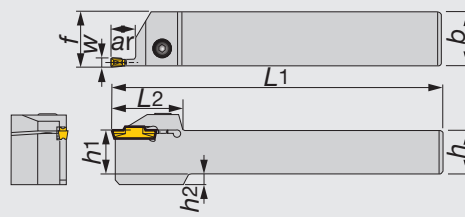
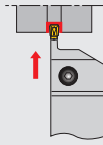

Insert:
DGM, SGM, DGS,
SGS, DGG, DTX,
DTE, DTR, DTA, SGN

Right hand (R) shown.

Inch	W (in)	W (mm)	Seat size	ar	h	b	L1	L2	h1	f ⁽¹⁾	h2
CTER/L10-2T08	0.079	2	2	0.315	0.625	0.625	4.500	1.299	0.625	0.629	0.157
CTER/L12-2T08	0.079	2	2	0.315	0.750	0.750	5.000	1.299	0.750	0.754	-
CTER/L16-2T08	0.079	2	2	0.315	1.000	1.000	6.000	1.299	1.000	1.004	-
CTER/L10-2T12	0.079	2	2	0.472	0.625	0.625	4.500	1.260	0.625	0.629	0.157
CTER/L12-2T12	0.079	2	2	0.472	0.750	0.750	5.000	1.260	0.750	0.754	-
CTER/L16-2T12	0.079	2	2	0.472	1.000	1.000	6.000	1.260	1.000	1.004	-
CTER/L10-2T17	0.079	2	2	0.669	0.625	0.625	4.500	1.457	0.625	0.629	0.157
CTER/L12-2T17	0.079	2	2	0.669	0.750	0.750	5.000	1.457	0.750	0.754	-
CTER/L16-2T17	0.079	2	2	0.669	1.000	1.000	6.000	1.457	1.000	1.004	-
CTER/L10-3T09	0.118	3	3	0.354	0.625	0.625	4.500	1.260	0.625	0.637	0.157
CTER/L12-3T09	0.118	3	3	0.354	0.750	0.750	5.000	1.260	0.750	0.762	-
CTER/L16-3T09	0.118	3	3	0.354	1.000	1.000	6.000	1.260	1.000	1.012	-
CTER/L12-3T12	0.118	3	3	0.472	0.750	0.750	5.000	1.260	0.750	0.763	-
CTER/L16-3T12	0.118	3	3	0.472	1.000	1.000	6.000	1.260	1.000	1.012	-
CTER/L10-3T20	0.118	3	3	0.787	0.625	0.625	4.500	1.516	0.625	0.637	-
CTER/L12-3T20	0.118	3	3	0.787	0.750	0.750	5.000	1.516	0.750	0.762	-
CTER/L16-3T20	0.118	3	3	0.787	1.000	1.000	6.000	1.516	1.000	1.012	0.157
CTER/L16-3T25	0.118	3	3	0.984	1.000	1.000	6.000	1.752	1.000	1.012	-
CTER/L10-4T10	0.157	4	4	0.394	0.625	0.625	4.500	1.260	0.625	0.645	-
CTER/L12-4T10	0.157	4	4	0.394	0.750	0.750	5.000	1.260	0.750	0.770	-
CTER/L16-4T10	0.157	4	4	0.394	1.000	1.000	6.000	1.260	1.000	1.020	0.157
CTER/L12-4T15	0.157	4	4	0.590	0.750	0.750	5.000	1.299	0.750	0.770	-
CTER/L16-4T15	0.157	4	4	0.590	1.000	1.000	6.000	1.299	1.000	1.020	-
CTER/L10-4T25	0.157	4	4	0.984	0.625	0.625	4.500	1.772	0.625	0.645	-
CTER/L12-4T25	0.157	4	4	0.984	0.750	0.750	5.000	1.772	0.750	0.770	-
CTER/L16-4T25	0.157	4	4	0.984	1.000	1.000	6.000	1.772	1.000	1.020	-
CTER/L20-4T25	0.157	4	4	0.984	1.250	1.250	7.000	1.772	1.250	1.270	-
CTER/L12-5T12	0.197	5	5	0.472	0.750	0.750	5.000	1.457	0.750	0.774	0.157
CTER/L16-5T12	0.197	5	5	0.472	1.000	1.000	6.000	1.457	1.000	1.024	-
CTER/L16-5T20	0.197	5	5	0.787	1.000	1.000	6.000	1.457	1.000	1.024	-
CTER/L16-5T32	0.197	5	5	1.260	1.000	1.000	6.000	2.205	1.000	1.024	-
CTER/L20-5T32	0.197	5	5	1.260	1.250	1.250	7.000	2.205	1.250	1.274	-
CTER/L12-6T12	0.236	6	6	0.472	0.750	0.750	5.000	1.457	0.750	0.770	-
CTER/L16-6T12	0.236	6	6	0.472	1.000	1.000	6.000	1.457	1.000	1.020	-
CTER/L16-6T20	0.236	6	6	0.787	1.000	1.000	6.000	1.614	1.000	1.023	-
CTER/L16-6T32	0.236	6	6	1.260	1.000	1.000	6.000	2.205	1.000	1.020	-
CTER/L20-6T32	0.236	6	6	1.260	1.250	1.250	7.000	2.205	1.250	1.270	-
CTER/L16-8T16	0.315	8	8	0.630	1.000	1.000	6.000	1.850	1.000	1.039	-
CTER/L16-8T25	0.315	8	8	0.984	1.000	1.000	6.000	1.850	1.000	1.039	-
CTER/L20-8T25	0.315	8	8	0.984	1.250	1.250	7.000	1.850	1.250	1.289	0.276
CTER/L16-8T36	0.315	8	8	1.417	1.000	1.000	6.000	2.362	1.000	1.039	-
CTER/L20-8T36	0.315	8	8	1.417	1.250	1.250	7.000	2.362	1.250	1.289	0.276

• When depth is deeper than (insert length - 0.059"), 1 corner type is recommended.
(1) "f" value is calculated with groove width "W" shown in the table.

Reference pages

Inserts → C079 - C091, Standard cutting conditions → C091



External



Parting-off

Others



Grooving Tool

Metric	W	Seat size	ar	h	b	L1	L2	h1	f ⁽¹⁾	h2
CTER/L1616-2T08	2	2	8	16	16	110	33	16	16.1	4
CTER/L2020-2T08	2	2	8	20	20	125	33	20	20.1	-
CTER/L2525-2T08	2	2	8	25	25	150	33	25	25.1	-
CTER/L1616-2T12	2	2	12	16	16	110	32	16	16.1	4
CTER/L2020-2T12	2	2	12	20	20	125	32	20	20.1	-
CTER/L2525-2T12	2	2	12	25	25	150	32	25	25.1	-
CTER/L1616-2T17	2	2	17	16	16	110	37	16	16.1	4
CTER/L2020-2T17	2	2	17	20	20	125	37	20	20.1	-
CTER/L2525-2T17	2	2	17	25	25	150	37	25	25.1	-
CTER/L1616-3T09	3	3	9	16	16	110	32	16	16.3	4
CTER/L2020-3T09	3	3	9	20	20	125	32	20	20.3	-
CTER/L2525-3T09	3	3	9	25	25	150	32	25	25.3	-
CTER/L2020-3T12	3	3	12	20	20	125	32	20	20.3	-
CTER/L2525-3T12	3	3	12	25	25	150	32	25	25.3	-
CTER/L1616-3T20	3	3	20	16	16	110	38.5	16	16.3	4
CTER/L2020-3T20	3	3	20	20	20	125	38.5	20	20.3	-
CTER/L2525-3T20	3	3	20	25	25	150	38.5	25	25.3	-
CTER/L2525-3T25	3	3	25	25	25	150	44.5	25	25.3	-
CTER/L1616-4T10	4	4	10	16	16	110	32	16	16.5	4
CTER/L2020-4T10	4	4	10	20	20	125	32	20	20.5	-
CTER/L2525-4T10	4	4	10	25	25	150	32	25	25.5	-
CTER/L2020-4T15	4	4	15	20	20	125	33	20	20.5	-
CTER/L2525-4T15	4	4	15	25	25	150	33	25	25.5	-
CTER/L1616-4T25	4	4	25	16	16	110	45	16	16.5	4
CTER/L2020-4T25	4	4	25	20	20	125	45	20	20.5	-
CTER/L2525-4T25	4	4	25	25	25	150	45	25	25.5	-
CTER/L3232-4T25	4	4	25	32	32	170	45	32	32.5	-
CTER/L2020-5T12	5	5	12	20	20	125	37	20	20.6	-
CTER/L2525-5T12	5	5	12	25	25	150	37	25	25.6	-
CTER/L2525-5T20	5	5	20	25	25	150	37	25	25.6	-
CTER/L2525-5T32	5	5	32	25	25	150	56	25	25.6	-
CTER/L3232-5T32	5	5	32	32	32	170	56	32	32.6	-
CTER/L2020-6T12	6	6	12	20	20	125	37	20	20.6	-
CTER/L2525-6T12	6	6	12	25	25	150	37	25	25.6	7
CTER/L2525-6T20	6	6	20	25	25	150	41	25	25.6	-
CTER/L2525-6T32	6	6	32	25	25	150	56	25	25.6	7
CTER/L3232-6T32	6	6	32	32	32	170	56	32	32.6	-
CTER/L2525-8T16	8	8	16	25	25	150	47	25	26.1	7
CTER/L2525-8T25	8	8	25	25	25	150	47	25	26.1	7
CTER/L3232-8T25	8	8	25	32	32	170	47	32	33.1	-
CTER/L2525-8T36	8	8	36	25	25	150	60	25	26.1	7
CTER/L3232-8T36	8	8	36	32	32	170	60	32	33.1	-

• When depth is deeper than (insert length - 0.059"), 1 corner type is recommended. (1) "f" value is calculated with groove width "W" shown in the table.

TUNGSCUT



External

SPARE PARTS



Designation	Clamping screw	Wrench
CTER/L10-2T08, CTER/L1616-2T08	CM5X0.8X16-A	P-4
CTER/L12-2T08, CTER/L2020-2T08	CM5X0.8X20-A	P-4
CTER/L16-2T08, CTER/L2525-2T08	CM5X0.8X25-A	P-4
CTER/L10-2T12, CTER/L1616-2T12	CM5X0.8X16-A	P-4
CTER/L12-2T12, CTER/L2020-2T12	CM5X0.8X20-A	P-4
CTER/L16-2T12, CTER/L2525-2T12	CM5X0.8X25-A	P-4
CTER/L10-2T17, CTER/L1616-2T17	CM5X0.8X16-A	P-4
CTER/L12-2T17, CTER/L2020-2T17	CM5X0.8X20-A	P-4
CTER/L16-2T17, CTER/L2525-2T17	CM5X0.8X25-A	P-4
CTER/L10-3T09, CTER/L1616-3T09	CM5X0.8X16-A	P-4
CTER/L12-3T09, CTER/L2020-3T09	CM5X0.8X20-A	P-4
CTER/L12-3T12, CTER/L2525-3T09	CM5X0.8X25-A	P-4
CTER/L16-3T12, CTER/L2020-3T12	CM5X0.8X20-A	P-4
CTER/L10-3T20, CTER/L2525-3T12	CM5X0.8X25-A	P-4
CTER/L12-3T20, CTER/L1616-3T20	CM5X0.8X16-A	P-4
CTER/L16-3T20, CTER/L2020-3T20	CM5X0.8X20-A	P-4
CTER/L16-3T25, CTER/L2525-3T20.25	CM5X0.8X25-A	P-4
CTER/L10-4T10, CTER/L1616-4T10	CM6X1X16-A	P-5
CTER/L12-4T10, CTER/L2020-4T10	CM6X1X20-A	P-5

SPARE PARTS



Designation	Clamping screw	Wrench
CTER/L16-4T10, CTER/L2525-4T10	CM6X1X25-A	P-5
CTER/L12-4T15, CTER/L2020-4T15	CM6X1X20-A	P-5
CTER/L16-4T15, CTER/L2525-4T15	CM6X1X25-A	P-5
CTER/L10-4T25, CTER/L1616-4T25	CM6X1X16-A	P-5
CTER/L12-4T25, CTER/L2020-4T25	CM6X1X20-A	P-5
CTER/L16-4T25, CTER/L2525-4T25	CM6X1X25-A	P-5
CTER/L20-4T25, CTER/L3232-4T25	CM6X1X25-A	P-5
CTER/L12-5T12, CTER/L16-5T12, CTER/L2020-5T12	CM6X1X20-A	P-5
CTER/L16-5T20, CTER/L2525-5T20	CM6X1X25-A	P-5
CTER/L16-5T32, CTER/L2525, 3232-5T32	CM6X1X25-A	P-5
CTER/L20-5T32, CTER/L2020-6T12	CM8X1.25X20-A	P-6
CTER/L12-6T12, CTER/L16-6T12, CTER/L2525-6T12	CM8X1.25X25-A	P-6
CTER/L16-6T20, CTER/L2525-6T20	CM8X1.25X25-A	P-6
CTER/L16-6T32, CTER/L20-6T32, CTER/L2525, 3232-6T32	CM8X1.25X25-A	P-6
CTER/L16-8T16, CTER/L2525-8T16	CM8X1.25X25-A	P-6
CTER/L16-8T25, CTER/L20-8T25, CTER/L2525, 3232-8T25	CM8X1.25X25-A	P-6
CTER/L16-8T36, CTER/L20-8T36, CTER/L2525, 3232-8T36	CM8X1.25X25-A	P-6



Parting-off

Others



Grooving Tool

TUNGSCUT

JCTER/L

External grooving & parting toolholders for swiss lathes

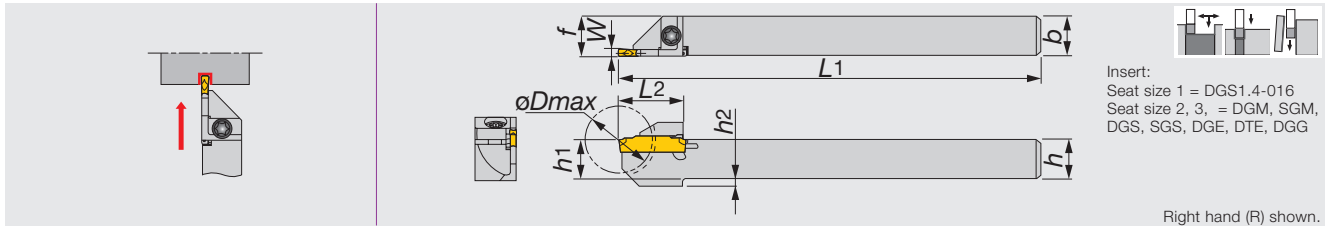

Inch	W	Seat size	øDmax	h	b	L1	L2	h1	f ⁽¹⁾	h2
JCTER/L08-2T12	0.079	1	0.945	0.500	0.500	4.750	0.748	0.500	0.504	0.051
JCTER/L08-3T12	0.118	1	0.945	0.500	0.500	4.750	0.748	0.500	0.512	0.051
JCTER/L10-2T16	0.079	1	1.260	0.625	0.625	4.750	0.945	0.625	0.629	-
JCTER/L10-3T16	0.118	1	1.260	0.625	0.625	4.750	0.945	0.625	0.637	-

Metric	W	Seat size	øDmax	h	b	L1	L2	h1	f ⁽¹⁾	h2
JCTER/L1010X1.4T10	1.4	1	20	10	10	120	18	10	10.2	-
JCTER/L1010-1.4T10	1.4	1	20	10	10	125	18	10	10.2	-
JCTER/L1212F1.4T12	1.4	1	24	12	12	85	19.5	12	12.2	-
JCTER/L1212X1.4T12	1.4	1	24	12	12	120	19.5	12	12.2	-
JCTER/L1212-1.4T12	1.4	1	24	12	12	125	19.5	12	12.2	-
JCTER/L1414-1.4T12	1.4	1	24	14	14	125	19.5	14	14.2	-
JCTER/L1616X1.4T16	1.4	1	32	16	16	120	24	16	16.2	-
JCTER/L1616-1.4T16	1.4	1	32	16	16	125	24	16	16.2	-
JCTER/L1010X2T10	2	2	20	10	10	120	19	10	10.1	2
JCTER/L1010-2T10	2	2	20	10	10	125	19	10	10.1	2
JCTER/L1212F2T12	2	2	24	12	12	85	19	12	12.1	2
JCTER/L1212X2T12	2	2	24	12	12	120	19	12	12.1	2
JCTER/L1212-2T12	2	2	24	12	12	125	19	12	12.1	2
JCTER/L1414-2T12	2	2	24	14	14	125	19	14	14.1	-
JCTER/L1616X2T16	2	2	32	16	16	120	24	16	16.1	-
JCTER/L1616-2T16	2	2	32	16	16	125	24	16	16.1	-
JCTER/L1212F3T12	3	3	24	12	12	85	19	12	12.3	2
JCTER/L1212X3T12	3	3	24	12	12	120	19	12	12.3	2
JCTER/L1212-3T12	3	3	24	12	12	125	19	12	12.3	2
JCTER/L1616X3T16	3	3	32	16	16	120	24	16	16.3	-
JCTER/L1616-3T16	3	3	32	16	16	125	24	16	16.3	-
JCTER/L2020H3T16	3	3	32	20	20	100	24	20	20.3	-
JCTER/L2020-3T16	3	3	32	20	20	125	24	20	20.3	-

(1) "f" value is calculated with groove width "W" shown in the table. • øDmax: Max. parting off dia.



External



Parting-off

Others

SPARE PARTS

Designation	Clamping screw	Wrench
JCTER/L...	CSHB-4-A	T-15F

Reference pages

Inserts → C079 - C091, Standard cutting conditions → C091

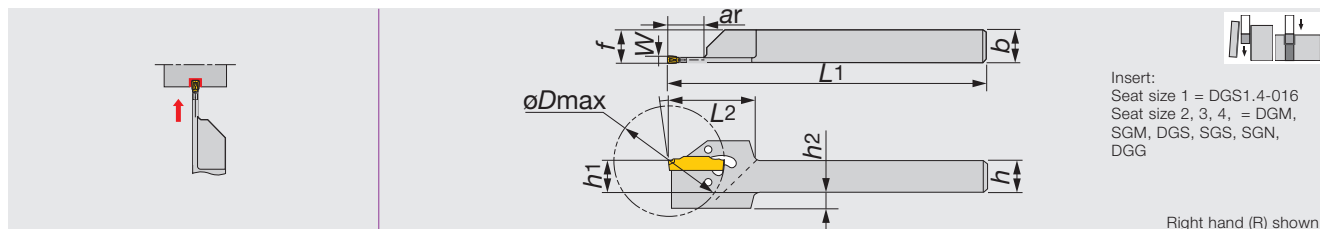

Insert:
Seat size 1 = DGS1.4-016
Seat size 2, 3, 4, = DGM,
SGM, DGS, SGS, SGN,
DGG

Right hand (R) shown.

Metric	W	Seat size	øDmax ⁽¹⁾	ar	h	b	L1	L2	h1	f ⁽²⁾	h2
CGER/L2020-1.4T14	1.4	1	29/29	9.7	20	20	125	31	20	20.2	-
CGER/L1212-2T17	2	2	35/35	11.8	12	12	150	31	12	12.1	6
CGER/L1616-2T17	2	2	35/35	11.8	16	16	150	31	16	16.1	2
CGER/L2020-2T17	2	2	35/35	9.8	20	20	125	31	20	20.1	-
CGER/L1212-3T19	3	3	38/40	12	12	12	150	31	12	12.3	6
CGER/L1616-3T19	3	3	38/45	14.9	16	16	150	31	16	16.3	2
CGER/L2020-3T19	3	3	38/45	13.2	20	20	125	31	20	20.3	-
CGER/L2020-4T19	4	4	38/55	20.3	20	20	125	33	20	20.4	-

SPARE PARTS

Designation	Wrench
CGER/L2020-1.4T14	CRW23
CGER/L***-2T17 - 4T19	CRW33

• Wrench, CRW**, should be ordered separately. Insert is clamped by the elastic deformation of upper jaw. (1) DG*/SG* Maximum diameter of parting off Dmax, can be increased by using SG* insert for some toolholders. (2) *f* value is calculated with groove width *W* shown in the table. • øDmax: Max. parting off dia.

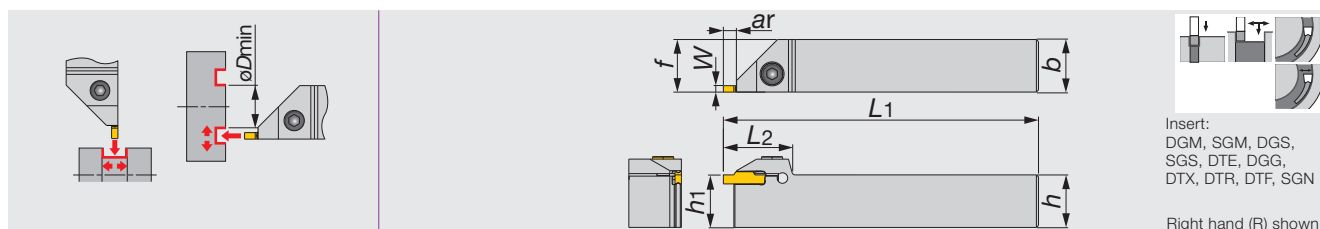

Insert:
DGM, SGM, DGS,
SGS, DTE, DGG,
DTX, DTR, DTF, SGN

Right hand (R) shown.

Inch	W (in)	W (mm)	Seat size	ar	h1	b	h	L1	f	L2
CTEFR/L12-4T04	0.079, 0.118, 0.157	4	2, 3, 4	0.189	0.750	0.750	0.750	5.000	0.770	1.300
CTEFR/L16-4T04	0.079, 0.118, 0.157	4	2, 3, 4	0.189	1.000	1.000	1.000	6.000	1.020	1.300
CTEFR/L12-6T04	0.197, 0.236	6	5, 6	0.189	0.750	0.750	0.750	5.000	0.236	1.460
CTEFR/L16-6T04	0.197, 0.236	6	5, 6	0.189	1.000	1.000	1.000	6.000	1.020	1.460

(1) *f* value is calculated with groove width *W* shown in the table.

SPARE PARTS

Designation	Clamping screw	Wrench
CTEFR/L12-4T04	CM6X1X20-A	P-5
CTEFR/L16-4T04	CM6X1X25-A	P-5
CTEFR/L12-6T04	CM6X1X20-A	P-5
CTEFR/L16-6T04	CM6X1X25-A	P-5

Insert	Groove width		Min. dia. for face grooving øDmin (in)
	W (in)		
DGM / DGS / SGN	0.078		11.614
DGM / DGS / SGN	0.118		2.126
DGM / DGS / SGN	0.157		1.339
DGM / DGS	0.196		1.929
DGM / DGS	0.236		1.811
DTE / DGG	0.118		1.732
DTE / DGG	0.157		1.654
DTE / DGG	0.196		1.969
DTE / DGG	0.236		1.890

Insert	Groove width		Min. dia. for face grooving øDmin (in)
	W (in)		
DTR	0.118		1.614
DTR	0.157		1.417
DTR	0.196		2.126
DTR	0.236		2.126
DTX	0.118		0.709
DTX	0.157		0.709
DTX	0.196		0.787
DTX	0.236		0.709
DTF	0.118		0.709
DTF	0.157		0.787

Reference pages

Inserts → C079 - C091, Standard cutting conditions → C091



Grooving Tool

TUNGCUT

CAER/L

Blades for external grooving & parting & turning

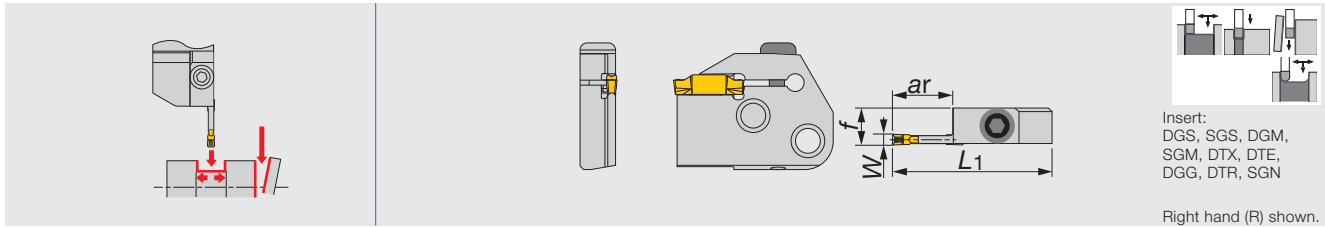

Inch	W (in)	W (mm)	Seat size	ar	L1	f	Shank
CAER/L-3T16	0.118	3	3	0.630	1.772	0.409	CHFVL/R...,CHSR/L...
CAER/L-4T16	0.157	4	4	0.630	1.772	0.413	CHFVL/R...,CHSR/L...
CAER/L-5T20	0.197	5	5	0.787	1.929	0.413	CHFVL/R...,CHSR/L...
CAER/L-6T20	0.236	6	6	0.787	1.929	0.413	CHFVL/R...,CHSR/L...

SPARE PARTS

Designation	Clamping screw	Wrench
CAER/L...	BHM6-20-A	P-4

TUNGCUT

TUNGCUT

CHSR/L

Shank of toolholders for CAER/L & CAFR/L blades

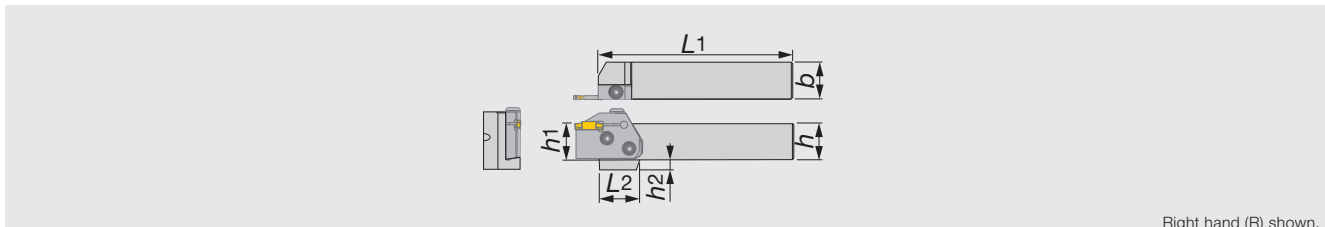

Inch	h	b	L1	L2	h1	h2	Blade*
CHSR/L12-U	0.075	0.075	5.33	1.378	0.075	0.510	CAER/L...,CAFL/R...
CHSR/L16-U	1.000	1.000	5.33	1.102	1.000	0.280	CAER/L...,CAFL/R...
CHSR/L20-U	1.250	1.250	6.330	1.102	1.250	-	CAER/L...,CAFL/R...

Metric	h	b	L1	L2	h1	h2	Blade*
CHSR/L2020	20	20	133	35	20	12	CAER/L...,CAFL/R...
CHSR/L2525	25	25	133	28	25	7	CAER/L...,CAFL/R...
CHSR/L3232	32	32	153	28	32	-	CAER/L...,CAFL/R...

* Blade sold separately.

SPARE PARTS

Designation	Clamping screw	Wrench
CHSR/L...	CSHB-6-A	P-4

Combination of blade and toolholder

Toolholders	Blade			
	CAER...	CAEL...	CAFR...	CAFL...
CHSR...	●			●
CHSL...		●	●	

● : Corresponding

Reference pages

Inserts → C079 - C091, Standard cutting conditions → C091

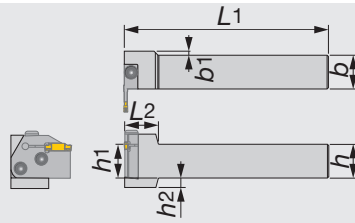

Right hand (R) shown.

Inch	<i>h</i>	<i>b</i>	<i>L1</i>	<i>L2</i>	<i>h1</i>	<i>h2</i>	<i>b1</i>	Blade
CHFVR/L12-U	0.075	0.075	6.000	0.980	0.075	0.500	0.315	CAEL/R...,CAFR/L...
CHFVR/L16-U	1.000	1.000	6.000	0.980	1.000	0.280	0.118	CAEL/R...,CAFR/L...
CHFVR/L20-U	1.250	1.250	7.000	0.980	1.250	-	-	CAEL/R...,CAFR/L...

SPARE PARTS



Designation	Clamping screw	Wrench
CHFVR/L...	C SHB-6-A	P-4

Combination of blade and toolholder

Toolholders	Blade			
	CAER...	CAEL...	CAFR...	CAFL...
CHFVR...		●	●	
CHFVL...	●			●

● : Corresponding



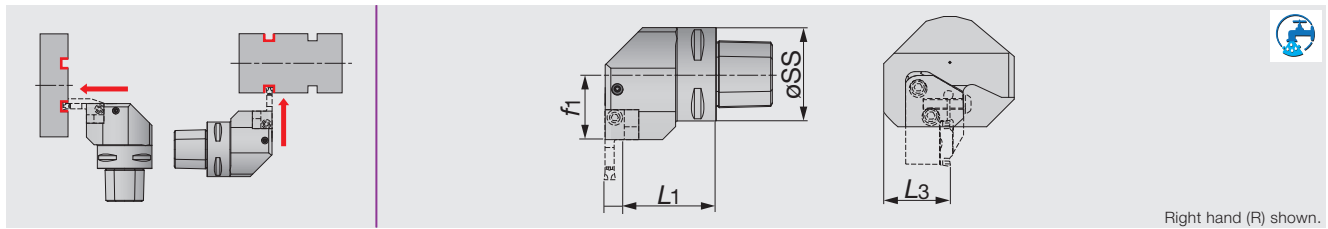

Right hand (R) shown.

Metric	øSS	L1	L3	f1
C4CHFVR/L27050N	40	42.5	36	27
C5CHFVR/L35060N	50	49.5	36	35
C6CHFVR/L45065	63	54.5	41	45
C6CHFVR/L45065N	63	54.5	41	45

• The last character of designation is "N": Capable for 7 Mpa coolant pressure.

SPARE PARTS

Designation	Coolant parts	Coolant parts 1	Plug	Clamping screw	Wrench
C4CHFVR/L27050N	SATZ-M8X1-M3	-	SSHM4-4	CSHB-6-A	P-4
C5CHFVR/L35060N	SATZ-M10X1-M5	-	SSHM4-4	CSHB-6-A	P-4
C6CHFVR/L45065	CNZ125	PNZ5	-	CSHB-6-A	P-4
C6CHFVR/L45065N	SATZ-M10X1-M5	-	SSHM4-4	CSHB-6-A	P-4

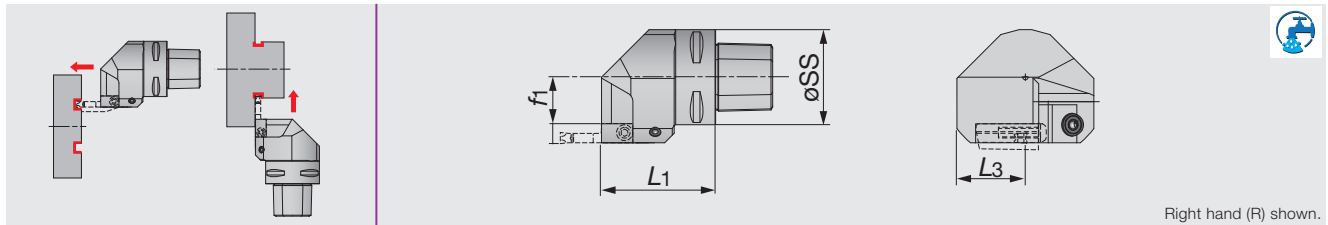
C-CHSR/L

Right hand (R) shown.

Metric	øSS	L1	L3	f1
C4CHSR/L27050N	40	50	36	16.5
C5CHSR/L35060	50	60	36	24.5
C5CHSR/L35060N	50	60	36	24.5
C6CHSR/L45065N	63	65	41	34.5

• The last character of designation is "N": Capable for 7 Mpa coolant pressure.

SPARE PARTS

Designation	Coolant parts	Coolant parts 1	Plug	Clamping screw	Wrench
C4CHSR/L27050N	SATZ-M8X1-M3	-	SSHM4-4	CSHB-6-A	P-4
C5CHSR/L35060	CNZ125	PNZ5	-	CSHB-6-A	P-4
C5CHSR/L35060N	SATZ-M10X1-M5	-	SSHM4-4	CSHB-6-A	P-4
C6CHSR/L45065N	SATE-M10X1-M5	-	SSHM4-4	CSHB-6-A	P-4

Combination of blade and toolholder

Toolholders	Blade			
	CAER...	CAEL...	CAFR...	CAFL...
C*CHFVR...		●	●	
C*CHFVL...	●			●
C*CHSR...	●			●
C*CHSL...		●	●	

● : Corresponding

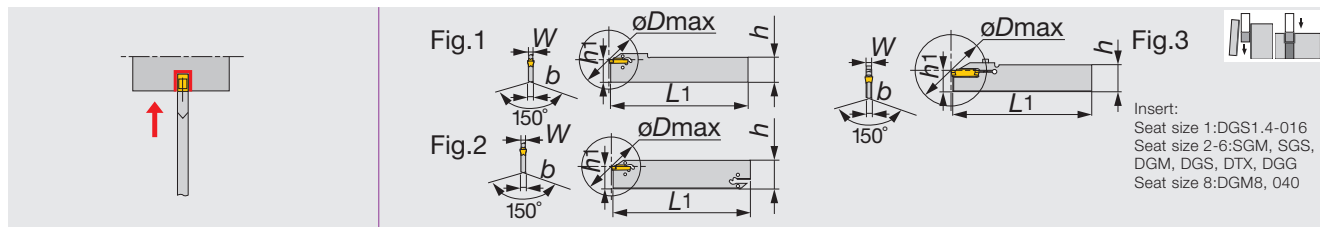

Inch	W (in)	W (mm)	Seat size	øDmax	h1	b	h	L1	Fig
CGP26-1.4S	0.055	1.4	1	1.024	0.843	0.039	1.024	5.906	1
CGP32-1.4D	0.055	1.4	1	1.024	0.976	0.039	1.260	5.906	2
CGP26-2S	0.079	2	2	1.575	0.843	0.071	1.024	5.906	1
CGP32-2D	0.079	2	2	1.969	0.976	0.071	1.260	5.906	2
CGP26-3S	0.118	3	3	1.969	0.843	0.094	1.024	5.906	1
CGP32-3D	0.118	3	3	3.937	0.976	0.094	1.260	5.906	2
CGP26-4S	0.157	4	4	3.150	0.843	0.126	1.024	5.906	1
CGP32-4D	0.157	4	4	3.937	0.980	0.126	1.260	5.906	2
CGP45-4D	0.157	4	4	4.724	1.500	0.126	1.772	5.906	2
CGP32-5D	0.197	5	5	4.724	0.980	0.157	1.260	5.906	2
CGP32-6D	0.236	6	6	4.724	0.980	0.205	1.260	5.906	2
CGP32-8S-CL	0.315	8	8	3.150	0.980	0.244	1.260	5.906	3

- When depth is deeper than (insert length - 0.059"), 1 corner type is recommended. • Wrench (CRW**) should be ordered separately.
- Max groove depth is 1.122".
- øDmax: Max. parting off dia.

SPARE PARTS

Designation	Clamping screw	Wrench
CGP**-1.4*	-	CRW23
CGP**-2/3/4/5/6	-	CRW33
CGP32-8S-CL	CM4X0.7X20-M0-A	P-3

Caution

Newly developed wrench

Insert is clamped by the elastic deformation of upper jaw. Low clamping stress increases the stability and tool life.

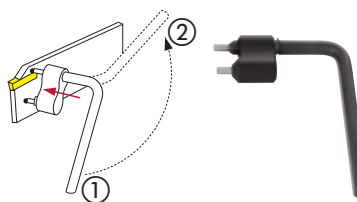

- ① → ②: unclamp
- ② → ①: clamp

**TUNG**CUT**CTBF**

Tool block for CGP blades(fixed clamp)

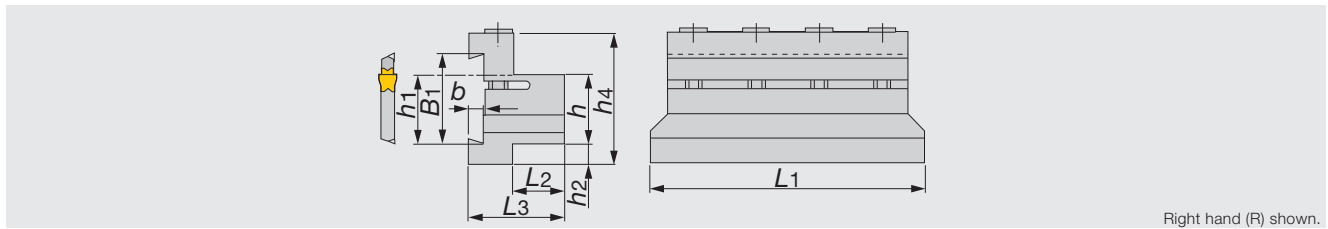

Inch	<i>h</i>	B1	<i>L2</i>	<i>L1</i>	<i>b</i>	<i>h1</i>	<i>h2</i>	<i>h4</i>	<i>L3</i>	Blade*
CTBF16-45-U	1.000	1.772	0.866	4.331	0.216	1.500	0.984	2.598	1.575	CGP45...
CTBF20-45-U	1.250	1.772	1.102	4.724	0.216	1.500	0.709	2.598	1.772	CGP45...
Metric	<i>h</i>	B1	<i>L2</i>	<i>L1</i>	<i>b</i>	<i>h1</i>	<i>h2</i>	<i>h4</i>	<i>L3</i>	Blade*
CTBF25-45	25	45	22	110	5.5	38.1	25	66	40	CGP45...
CTBF32-45	32	45	28	120	5.5	38.1	18	66	45	CGP45...

* Blade sold separately.

SPARE PARTS

Designation	Clamping screw	Wrench
CTBF...	CM6X1.0X40-A	P-5

TUNGCUT**CTBU**

Tool block for CGP and EGP blades

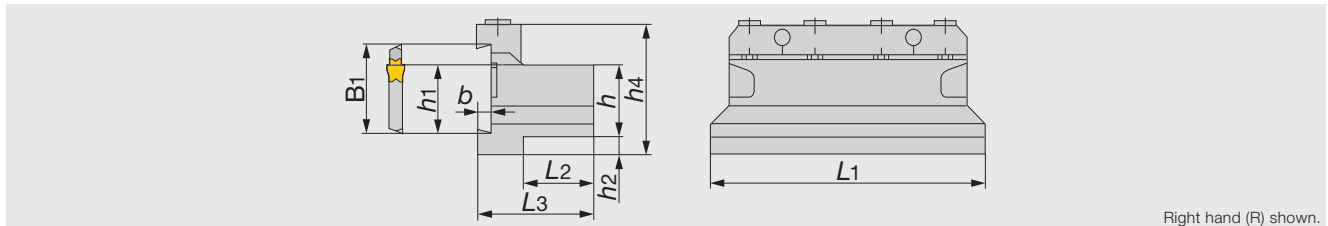

Inch	<i>h1</i>	<i>b</i>	B1	<i>L1</i>	<i>h</i>	<i>h2</i>	<i>h4</i>	<i>L2</i>	<i>L3</i>	Blade*
CTBU12-26-U	0.843	0.157	1.024	3.386	0.750	0.354	1.693	0.827	1.496	CGP26...
CTBU16-26-U	0.843	0.157	1.024	4.331	1.000	0.197	1.772	0.906	1.654	CGP26...
CTBU12-32-U	0.976	0.209	1.260	3.937	0.750	0.512	1.969	0.748	1.496	CGP32...
CTBU16-32-U	0.976	0.209	1.260	4.331	1.000	0.315	1.969	0.906	1.654	CGP32...
CTBU20-32-U	0.976	0.209	1.260	4.331	1.250	0.197	2.126	1.142	1.890	CGP32...
Metric	<i>h1</i>	<i>b</i>	B1	<i>L1</i>	<i>h</i>	<i>h2</i>	<i>h4</i>	<i>L2</i>	<i>L3</i>	Blade*
CTBU20-26	21.4	4	26	86	20	9	43	21	38	CGP26...
CTBU25-26	21.4	4	26	110	25	5	45	23	42	CGP26...
CTBU20-32	24.8	5.3	32	100	20	13	50	19	38	CGP32...
CTBU25-32	24.8	5.3	32	110	25	8	50	23	42	CGP32...
CTBU32-32	24.8	5.3	32	110	32	5	54	29	48	CGP32...

* Blade sold separately.

SPARE PARTS

Designation	Clamp	Clamping screw	Wrench
CTBU20-26...	CT-86	CM6X30-S	P-5
CTBU25-26...	CT-105	CM6X30-S	P-5
CTBU20-32...	CT-100	CM6X30-S	P-5
CTBU25-32...	CT-110	CM6X30-S	P-5
CTBU32-32...	CT-110	CM6X30-S	P-5

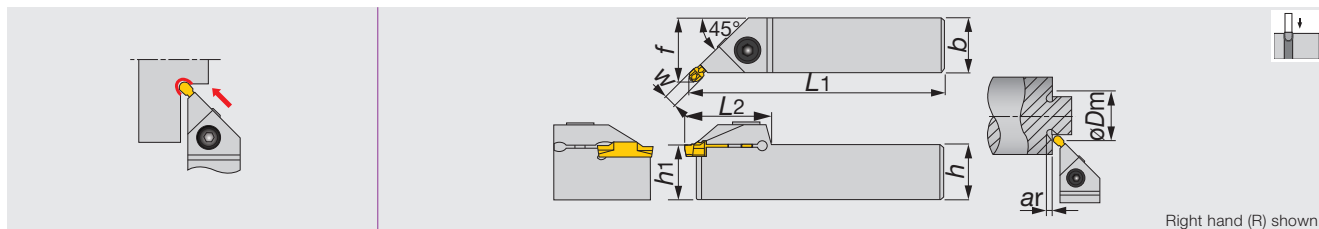

Right hand (R) shown.

Metric	W	ϕD_m	Seat size	ar	h	b	L1	L2	h1	f ⁽¹⁾	Insert
CGEUR/L1616-3T02	3	32	3	2.8	16	16	110	30	16	19.3	DTIU...
CGEUR/L2020-3T02	3	32	3	2.8	20	20	125	30	20	23.3	DTIU...
CGEUR/L2525-3T02	3	32	3	2.8	25	25	150	30	25	28.3	DTIU...
CGEUR/L1616-4T02	4	32	4	2.8	16	16	110	31	16	19.5	DTIU...
CGEUR/L2020-4T02	4	32	4	2.8	20	20	125	31	20	23.5	DTIU...
CGEUR/L2525-4T02	4	32	4	2.8	25	25	150	31	25	28.5	DTIU...
CGEUR/L2525-6T03	6	34	5, 6	3.4	25	25	150	35	25	28.9	DTIU...

(1) "f" value is calculated with groove width "W" shown in the table.

SPARE PARTS



Designation	Clamping screw	Wrench
CGEUR/L***-3T02	CM5X0.8X16-A	P-4
CGEUR/L1616-4T02	CM6X1X16-A	P-5
CGEUR/L2020-4T02	CM6X1X20-A	P-5
CGEUR/L2525-4T02/6T03	CM6X1X25-A	P-5

Reference pages

Inserts → C079 - C091, Standard cutting conditions → C091

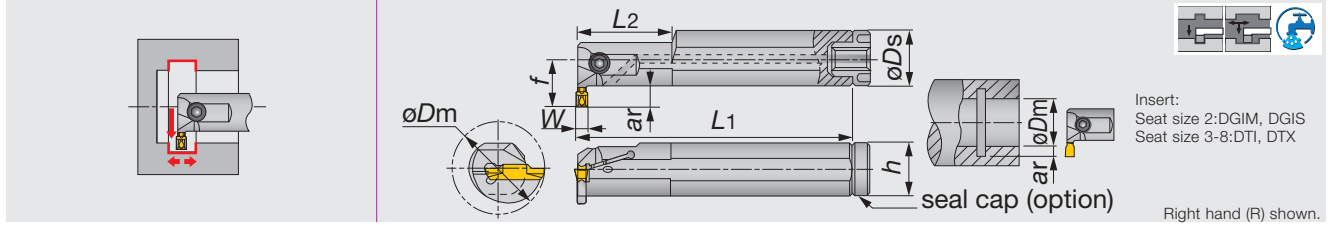

Inch	W	øDm	Seat size	ar	øDs	f	L1	L2	h	Insert
CTIR/L12-3T06-D16	0.118	1.000	3	0.236	0.750	0.609	6.500	1.575	0.551	DGIM..., DGIS...
CTIR/L16-3T05-D16	0.118	1.000	3	0.201	1.000	0.689	8.000	1.575	0.709	DGIM..., DGIS...
CTIR/L16-3T08-D20	0.118	1.250	3	0.315	1.000	0.846	8.000	1.575	0.709	DTI..., DTX...
CTIR/L20-3T10-D25	0.118	1.563	3	0.394	1.250	1.063	10.000	2.362	0.906	DTI..., DTX...
CTIR/L12-4T06-D16	0.157	1.000	4	0.236	0.750	0.609	6.500	1.575	0.906	DTI..., DTX...
CTIR/L16-4T08-D20	0.157	1.250	4	0.315	1.000	0.846	8.000	1.575	1.181	DTI..., DTX...
CTIR/L20-4T04-D20	0.157	1.250	4	0.157	1.250	0.819	10.000	2.362	0.709	DTI..., DTX...
CTIR/L20-4T10-D25	0.157	1.563	4	0.394	1.250	1.063	10.000	2.362	0.906	DTI..., DTX...
CTIR/L16-5T05-D20	0.197	1.250	5	0.197	1.000	0.681	8.000	2.362	1.181	DTI..., DTX...
CTIR/L20-5T10-D25	0.197	1.563	5	0.394	1.250	1.063	10.000	2.362	1.181	DTI..., DTX...
CTIR/L20-6T04-D20	0.236	1.250	6	0.157	1.250	0.820	10.000	2.362	0.906	DTI..., DTX...
CTIR/L20-6T10-D25	0.236	1.563	6	0.394	1.250	1.063	10.000	2.362	1.181	DTI..., DTX...
CTIR/L20-8T05-D23	0.315	1.438	8	0.197	1.250	0.839	10.000	2.362	1.181	DTI..., DTX...
CTIR/L24-8T05-D26	0.315	1.625	8	0.228	1.500	0.982	12.000	2.559	1.181	DTI..., DTX...

Metric	W	øDm	Seat size	ar	øDs	f	L1	L2	h	Insert
CTIR/L16-2T08-D250	2	25	2	8	16	16.5	125	-	14	DGIM..., DGIS...
CTIR/L20-2T06-D250	2	25	2	6	20	15.8	160	40	18	DGIM..., DGIS...
CTIR/L20-3T06-D250	3	25	3	6	20	15.8	160	40	18	DTI..., DTX...
CTIR/L25-3T05-D250	3	25	3	5.1	25	17.5	200	40	23	DTI..., DTX...
CTIR/L25-3T08-D320	3	32	3	8	25	21.5	200	40	23	DTI..., DTX...
CTIR/L32-3T10-D400	3	40	3	10	32	27	250	60	30	DTI..., DTX...
CTIR/L20-4T06-D250	4	25	4	6	20	15.8	160	40	18	DTI..., DTX...
CTIR/L25-4T08-D320	4	32	4	8	25	21.5	200	40	23	DTI..., DTX...
CTIR/L32-4T04-D310	4	31	4	4	32	20.8	250	60	30	DTI..., DTX...
CTIR/L32-4T10-D400	4	40	4	10	32	27	250	60	30	DTI..., DTX...
CTIR/L25-5T05-D310	5	31	5	5	25	17.3	200	60	23	DTI..., DTX...
CTIR/L32-5T10-D400	5	40	5	10	32	27	250	60	30	DTI..., DTX...
CTIR/L32-6T04-D310	6	31	6	4	32	20.8	250	60	30	DTI..., DTX...
CTIR/L32-6T10-D400	6	40	6	10	32	27	250	60	30	DTI..., DTX...
CTIR/L32-8T05-D370	8	37	8	5	32	21.3	250	60	30	DTI..., DTX...
CTIR/L40-8T05-D420	8	42	8	5.8	40	25.8	300	65	38	DTI..., DTX...

(1) "L1" value is calculated with groove width "W" shown in the table.

Inch SPARE PARTS



Designation	Clamping screw	Wrench	Seal cap	Thread type for connection
CTIR/L12-3T06-D16	CM5x0.8x12-A	P-4	CA-20	M6
CTIR/L16-3T05-D16	CM5x0.8x16-A	P-4	CA-25	R1/8"
CTIR/L16-3T08-D20	CM5x0.8x16-A	P-4	CA-25	R1/8"
CTIR/L20-3T10-D25	CM5x0.8x16-A	P-4	CA-32	R1/8"
CTIR/L12-4T06-D16	CM5x0.8x12-A	P-4	CA-20	M6
CTIR/L16-4T08-D20	CM5x0.8x16-A	P-4	CA-25	R1/8"
CTIR/L20-4T04-D20	CM5x0.8x16-A	P-4	CA-32	R1/8"
CTIR/L20-4T10-D25	CM5x0.8x16-A	P-4	CA-32	R1/8"
CTIR/L16-5T05-D20	CM6x1x16-A	P-5	CA-25	R1/8"
CTIR/L20-5T10-D25	CM6x1x20-A	P-5	CA-32	R1/8"
CTIR/L20-6T04-D20	CM6x1x20-A	P-5	CA-32	R1/8"
CTIR/L20-6T10-D25	CM6x1x20-A	P-5	CA-32	R1/8"
CTIR/L20-8T05-D23	CM6x1x25-A	P-5	CA-32	R1/8"
CTIR/L24-8T05-D26	CM6x1x25-A	P-5	CA-40	R1/8"

Metric SPARE PARTS



Designation	Clamping screw	Wrench	Seal cap	Thread type for connection
CTIR/L16-2T08-D250	CM5X0.8X10-A	P-4	CA-16	M6
CTIR/L20-2T06-D250	CM5X0.8X12-A	P-4	CA-20	M6
CTIR/L20-3T06-D250	CM5X0.8X12-A	P-4	CA-20	M6
CTIR/L25-3T05-D250	CM5X0.8X16-A	P-4	CA-25	R1/8"
CTIR/L25-3T08-D320	CM5X0.8X16-A	P-4	CA-25	R1/8"
CTIR/L32-3T10-D400	CM5X0.8X16-A	P-4	CA-32	R1/8"
CTIR/L20-4T06-D250	CM5X0.8X12-A	P-4	CA-20	M6
CTIR/L25-4T08-D320	CM5X0.8X16-A	P-4	CA-25	R1/8"
CTIR/L32-4T04-D310	CM5X0.8X16-A	P-4	CA-32	R1/8"
CTIR/L32-4T10-D400	CM5X0.8X16-A	P-4	CA-32	R1/8"
CTIR/L25-5T05-D310	CM6X1X16-A	P-5	CA-25	R1/8"
CTIR/L32-5T10-D400	CM6X1X20-A	P-5	CA-32	R1/8"
CTIR/L32-6T04-D310	CM6X1X20-A	P-5	CA-32	R1/8"
CTIR/L32-6T10-D400	CM6X1X20-A	P-5	CA-32	R1/8"
CTIR/L32-8T05-D370	CM6X1X25-A	P-5	CA-32	R1/8"
CTIR/L40-8T05-D420	CM6X1X25-A	P-5	CA-40	R1/8"

Reference pages

Inserts → C079 - C091, Standard cutting conditions → C091



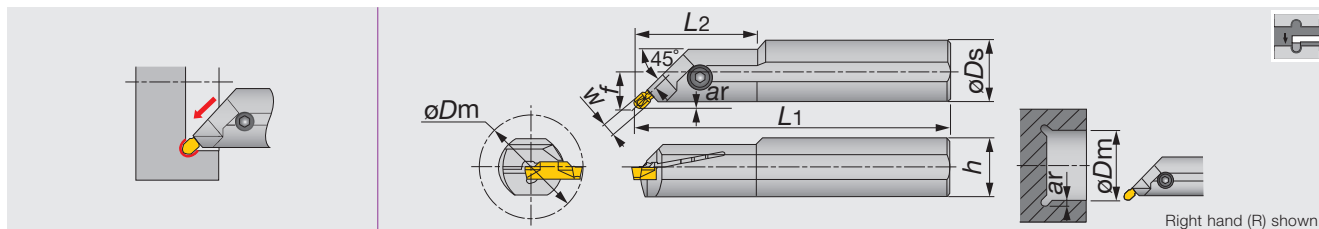

Right hand (R) shown.

Metric	W	øDm	Seat size	ar	øDs	f ⁽¹⁾	L1	L2	h	Insert
CGIUR/L20-3T02-D380	3	38	3	2.8	20	12.8	160	-	19	DTIU...
CGIUR/L25-3T02-D380	3	38	3	2.8	25	14.8	200	40	23	DTIU...
CGIUR/L20-4T02-D380	4	38	4	2.8	20	12.9	160	-	19	DTIU...
CGIUR/L25-4T02-D460	4	46	4	2.8	25	14.9	200	40	23	DTIU...
CGIUR/L25-6T02-D460	6	46	5, 6	2.8	25	15.2	200	-	23	DTIU...

(1) "f" value is calculated with groove width "W" shown in the table. . .

SPARE PARTS



Designation	Clamping screw	Wrench
CGIUR/L20-3T02-D380	CM5X0.8X12-A	P-4
CGIUR/L25-3T02-D380	CM5X0.8X16-A	P-4
CGIUR/L*-4T02-D...	CM5X0.8X16-A	P-4
CGIUR/L25-6T02-D460	CM6X1X25-A	P-5

Reference pages

Inserts → C079 - C091, Standard cutting conditions → C091

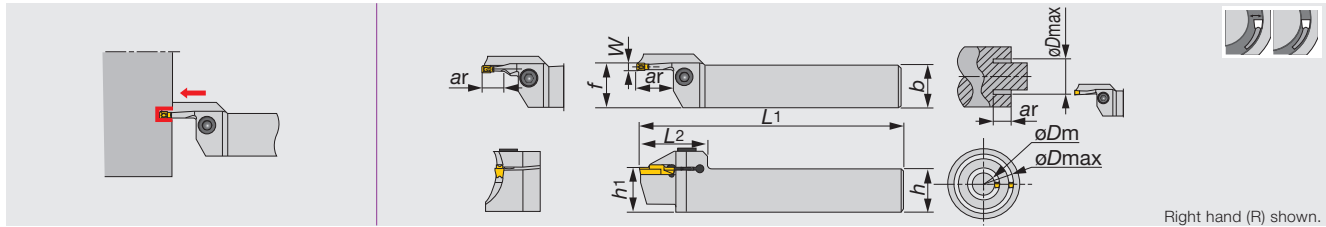

Metric	W	øDm	øDmax	Seat size	ar	h	b	L1	L2	h1	f ⁽¹⁾
CTFR/L2525-3T10-024035	3	24	35	3	10	25	25	150	38	25	25.5
CTFR/L2525-3T10-029040	3	29	40	3	10	25	25	150	38	25	25.5
CTFR/L2525-3T10-034050	3	34	50	3	10	25	25	150	38	25	25.5
CTFR/L2525-3T15-044070	3	44	70	3	15	25	25	150	38	25	25.5
CTFR/L2525-3T15-064100	3	64	100	3	15	25	25	150	38	25	25.5
CTFR/L2525-4T10-022036	4	22	36	4	10	25	25	150	39	25	25.6
CTFR/L2525-4T20-028042	4	28	42	4	20	25	25	150	39	25	25.6
CTFR/L2525-4T20-034050	4	34	50	4	20	25	25	150	39	25	25.6
CTFR/L2525-4T20-042070	4	42	70	4	20	25	25	150	39	25	25.6
CTFR/L2525-4T20-062120	4	62	120	4	20	25	25	150	39	25	25.6
CTFR/L2525-4T20-112200	4	112	200	4	20	25	25	150	39	25	25.6
CTFR/L2525-5T25-050080	5	50	80	5	25	25	25	150	49	25	25.6
CTFR/L2525-5T25-070110	5	70	110	5	25	25	25	150	49	25	25.6
CTFR/L2525-5T25-100150	5	100	150	5	25	25	25	150	49	25	25.6
CTFR/L2525-5T25-140200	5	140	200	5	25	25	25	150	49	25	25.6
CTFR/L2525-6T25-048070	6	48	70	6	25	25	25	150	49	25	25.6
CTFR/L2525-6T25-058100	6	58	100	6	25	25	25	150	49	25	25.6
CTFR/L2525-6T25-088180	6	88	180	6	25	25	25	150	49	25	25.6
CTFR/L2525-6T25-168400	6	168	400	6	25	25	25	150	49	25	25.6

- When depth is deeper than (insert length - 1.5 mm), 1 corner type is recommended.
- (1) "f" value is calculated with groove width "W" shown in the table.
- When DTF insert is installed, Max "ar" should be 15 mm.

SPARE PARTS

Designation	Clamping screw	Wrench
CTFR/L2525-3T - 4T...	CM6X1X25-A	P-5
CTFR/L2525-5T - 6T...	CM8X1.25X25-A	P-6

INSERT

Designation	Insert seat size	Insert
CTFR/L2525-3T10-024035	3	DTF, DTX
CTFR/L2525-3T10-029040	3	DTF, DTX
CTFR/L2525-3T10-034050	3	DTF, DTX
CTFR/L2525-3T15-044070	3	DTF, DTX, DTE, DTR
CTFR/L2525-3T15-064100	3	DTF, DTX, DTE, DGG, DGM, DGS, DTR
CTFR/L2525-4T10-022036	4	DTF, DTX
CTFR/L2525-4T20-028042	4	DTF, DTX
CTFR/L2525-4T20-034050	4	DTF, DTX
CTFR/L2525-4T20-042070	4	DTF, DTX, DTE, DGG, DGM, DGS, DTR
CTFR/L2525-4T20-062120	4	DTF, DTX, DTE, DGG, DGM, DGS, DTR
CTFR/L2525-4T20-112200	4	DTF, DTX, DTE, DGG, DGM, DGS, DTR
CTFR/L2525-5T25-...	5	DTX, DTE, DGG, DGM, DGS, DTR
CTFR/L2525-6T25-...	6	DTX, DTE, DGG, DGM, DGS, DTR

Reference pages

Inserts → **C079 - C091**, Standard cutting conditions → **C091**



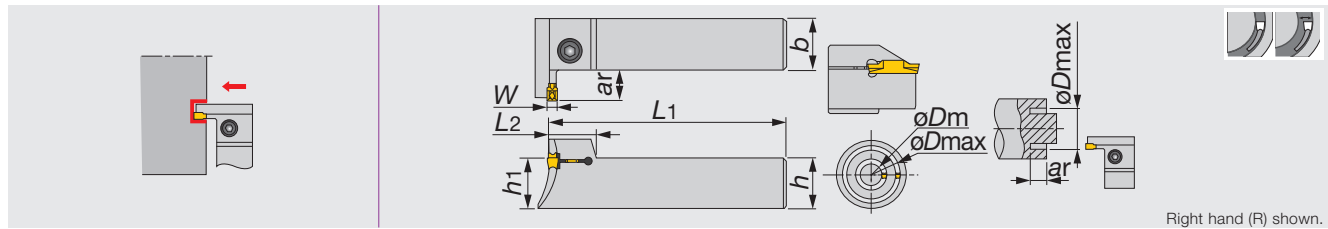

Metric	W	øDm	øDmax	Seat size	ar	h	b	L1	L2	h1
CTFVR/L2525-3T10-024035	3	24	35	3	10	25	25	150	18	25
CTFVR/L2525-3T10-029040	3	29	40	3	10	25	25	150	18	25
CTFVR/L2525-3T10-034050	3	34	50	3	10	25	25	150	18	25
CTFVR/L2525-3T15-044060	3	44	60	3	15	25	25	150	18	25
CTFVR/L2525-3T15-054085	3	54	85	3	15	25	25	150	18	25
CTFVR/L2525-4T12-022040	4	22	40	4	12	25	25	150	18.5	25
CTFVR/L2525-4T15-032050	4	32	50	4	15	25	25	150	18.5	25
CTFVR/L2525-4T15-042060	4	42	60	4	15	25	25	150	18.5	25
CTFVR/L2525-4T15-052085	4	52	85	4	15	25	25	150	18.5	25
CTFVR/L2525-5T20-050080	5	50	80	5	20	25	25	150	22	25
CTFVR/L2525-5T20-070110	5	70	110	5	20	25	25	150	22	25
CTFVR/L2525-5T20-100150	5	100	150	5	20	25	25	150	22	25
CTFVR/L2525-5T20-140200	5	140	200	5	20	25	25	150	22	25
CTFVR/L2525-6T20-048085	6	48	85	6	20	25	25	150	22	25
CTFVR/L2525-6T20-073150	6	73	150	6	20	25	25	150	22	25
CTFVR/L2525-6T20-138250	6	138	250	6	20	25	25	150	22	25

• When depth is deeper than (insert length - 1.5 mm), 1 corner type is recommended.

SPARE PARTS

Designation	Clamping screw	Wrench
CTFVR/L2525-3T...	CM5X0.8X25-A	P-4
CTFVR/L2525-4T...	CM6X1X25-A	P-5
CTFVR/L2525-5T..., 6T...	CM8X1.25X25-A	P-6

INSERT

Designation	Insert seat size	Insert
CTFVR/L2525-3T10-024035	3	DTF, DTX
CTFVR/L2525-3T10-029040	3	DTF, DTX
CTFVR/L2525-3T10-034050	3	DTF, DTX, DTR
CTFVR/L2525-3T15-044060	3	DTF, DTX, DTE, DTR
CTFVR/L2525-3T15-054085	3	DTF, DTX, DTE, DGG, DGM, DGS, DTR
CTFVR/L2525-4T12-022040	4	DTF, DTX
CTFVR/L2525-4T15-032050	4	DTF, DTX
CTFVR/L2525-4T15-042060	4	DTF, DTX, DTE, DGG, DGM, DGS, DTR
CTFVR/L2525-4T15-052085	4	DTF, DTX, DTE, DGG, DGM, DGS, DTR
CTFVR/L2525-5T20-...	5	DTX, DTE, DGG, DGM, DGS, DTR
CTFVR/L2525-6T20-...	6	DTX, DTE, DGG, DGM, DGS, DTR

(1) Min. diameter øDm of DTE, DGS and DGM insert

Insert	øDm	Note
DTE3 / DGS3 / DGM3	ø92	When diameter is smaller than øDm, DTF or DTX type insert is recommended.
DTE4 / DGS4 / DGM4	ø42	



Reference pages

Inserts → C079 - C091, Standard cutting conditions → C091

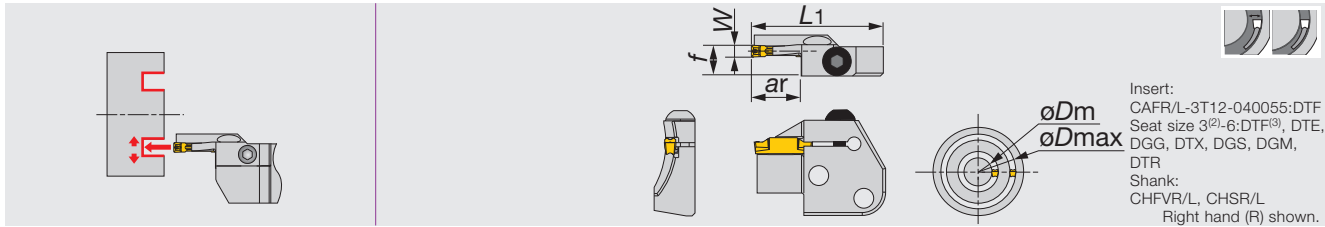

Insert:
CAFR/L-3T12-040055:DTF
Seat size 3⁽²⁾-6:DTF⁽³⁾, DTE,
DGG, DTX, DGS, DGM,
DTR
Shank:
CHFVR/L, CHSR/L
Right hand (R) shown.

Inch	W	øDm	øDmax	Seat size	ar	L1	f ⁽¹⁾
CAFR/L-3T12-040055	0.118	1.575	2.165	3	0.472	1.772	0.409
CAFR/L-3T12-055075	0.118	2.165	2.953	3	0.472	1.772	0.409
CAFR/L-3T12-075100	0.118	2.953	3.937	3	0.472	1.772	0.409
CAFR/L-3T12-100140	0.118	3.937	5.512	3	0.472	1.772	0.409
CAFR/L-3T12-140200	0.118	5.512	7.874	3	0.472	1.772	0.409
CAFR/L-4T16-050070	0.157	1.969	2.756	4	0.630	1.772	0.413
CAFR/L-4T16-070100	0.157	2.756	3.937	4	0.630	1.772	0.413
CAFR/L-4T16-100150	0.157	3.937	5.906	4	0.630	1.772	0.413
CAFR/L-4T16-150250	0.157	5.906	9.843	4	0.630	1.772	0.413
CAFR/L-5T20-055080	0.197	2.165	3.150	5	0.787	1.929	0.413
CAFR/L-5T20-080120	0.197	3.150	4.724	5	0.787	1.929	0.413
CAFR/L-5T20-120180	0.197	4.724	7.087	5	0.787	1.929	0.413
CAFR/L-5T20-180300	0.197	7.087	11.811	5	0.787	1.929	0.413
CAFR/L-5T20-300000	0.197	11.811	∞	5	0.787	1.929	0.413
CAFR/L-6T25-060090	0.236	2.362	3.543	6	0.984	2.165	0.413
CAFR/L-6T25-090150	0.236	3.543	5.906	6	0.984	2.165	0.413
CAFR/L-6T25-150250	0.236	5.906	9.843	6	0.984	2.165	0.413
CAFR/L-6T25-250400	0.236	9.843	15.748	6	0.984	2.165	0.413

• When depth is deeper than (insert length - 0.059"), 1 corner type is recommended.

(1) "f" value is calculated with groove width "W" shown in the table.

(2) Not applicable for CAFR/L-3T12-040055

(3) Seat sizes of DTF are Only 3 and 4

SPARE PARTS

Designation	Clamping screw	Wrench
CAFR/L...	BHM6-20-A	P-4

Min. diameter øDm of DTE, DGS and DGM insert

Insert	øDm	Note
DTE 3 / DGS 3 / DGM 3	ø1.733	When diameter is smaller than øDm, DTF or DTX type insert is recommended.
DTE 4 / DGS 4 / DGM 4	ø1.654	
DTE 5 / DGS 5 / DGM 5	ø1.969	
DTE 6 / DGS 6 / DGM 6	ø1.890	



Reference pages

Inserts → C079 - C091, Standard cutting conditions → C091

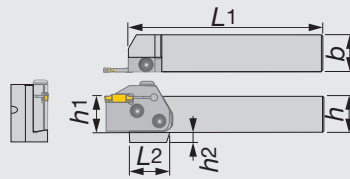

Right hand (R) shown.

Inch	h	b	L1	L2	h1	h2	Blade*
CHSR/L12-U	0.750	0.750	5.330	1.378	0.075	0.510	CAER/L...,CAFL/R...
CHSR/L16-U	1.000	1.000	5.330	1.102	1.000	0.280	CAER/L...,CAFL/R...
CHSR/L20-U	1.250	1.250	6.330	1.102	1.250	-	CAER/L...,CAFL/R...
Metric	h	b	L1	L2	h1	h2	Blade*
CHSR/L2020	20	20	133	35	20	12	CAER/L...,CAFL/R...
CHSR/L2525	25	25	133	28	25	7	CAER/L...,CAFL/R...
CHSR/L3232	32	32	153	28	32	-	CAER/L...,CAFL/R...

* Blade sold separately.

SPARE PARTS



Designation	Clamping screw	Wrench
CHSR/L...	CSHB-6-A	P-4

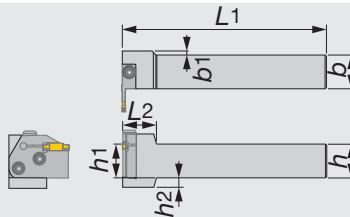

Right hand (R) shown.

Inch	h	b	L1	L2	h1	h2	b1	Blade*
CHFVR/L12-U	0.750	0.750	6.000	0.980	0.075	0.500	0.350	CAEL/R...,CAFR/L...
CHFVR/L16-U	1.000	1.000	6.000	0.980	1.000	0.280	0.120	CAEL/R...,CAFR/L...
CHFVR/L20-U	1.250	1.250	7.000	0.980	1.250	-	-	CAEL/R...,CAFR/L...
Metric	h	b	L1	L2	h1	h2	b1	Blade*
CHFVR/L2020	20	20	150	25	20	12	8	CAEL/R...,CAFR/L...
CHFVR/L2525	25	25	150	25	25	7	3	CAEL/R...,CAFR/L...
CHFVR/L3232	32	32	170	25	32	-	-	CAEL/R...,CAFR/L...

* Blade sold separately.

SPARE PARTS



Designation	Clamping screw	Wrench
CHFVR/L...	CSHB-6-A	P-4

Combination of blade and toolholder

Toolholders	Blade			
	CAER...	CAEL...	CAFR...	CAFL...
CHSR...	●			●
CHSL...		●	●	
CHFVR...		●	●	
CHFVL...	●			●

● : Corresponding

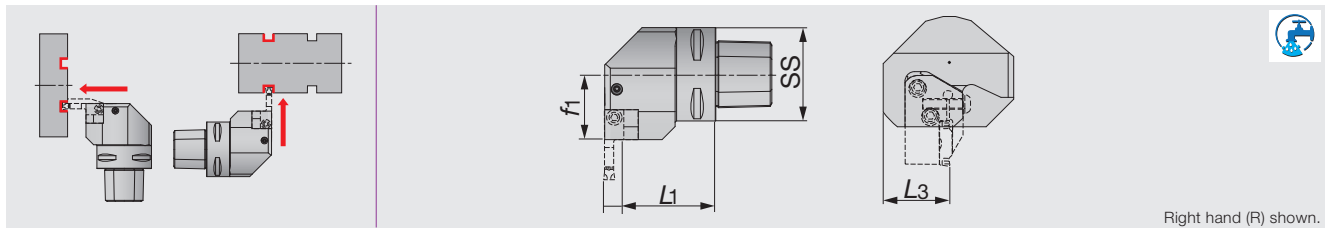

Right hand (R) shown.

Metric	SS	L1	L3	f1	Blade*
C4CHFVR/L27050N	40	42.5	36	27	CAEL/R..., CAFR/L...
C5CHFVR/L35060N	50	49.5	36	35	CAEL/R..., CAFR/L...
C6CHFVR/L45065	63	54.5	41	45	CAEL/R..., CAFR/L...
C6CHFVR/L45065N	63	54.5	41	45	CAEL/R..., CAFR/L...

* Blade sold separately.

• The last character of designation is "N": Capable for 7Mpa, coolant pressure.

SPARE PARTS

Designation	Coolant parts	Coolant parts 1	Plug	Clamping screw	Wrench
C4CHFVR/L27050N	SATZ-M8X1-M3	-	SSHM4-4	CSHB-6-A	P-4
C5CHFVR/L35060N	SATZ-M10X1-M5	-	SSHM4-4	CSHB-6-A	P-4
C6CHFVR/L45065	CNZ125	PNZ5	-	CSHB-6-A	P-4
C6CHFVR/L45065N	SATZ-M10X1-M5	-	SSHM4-4	CSHB-6-A	P-4

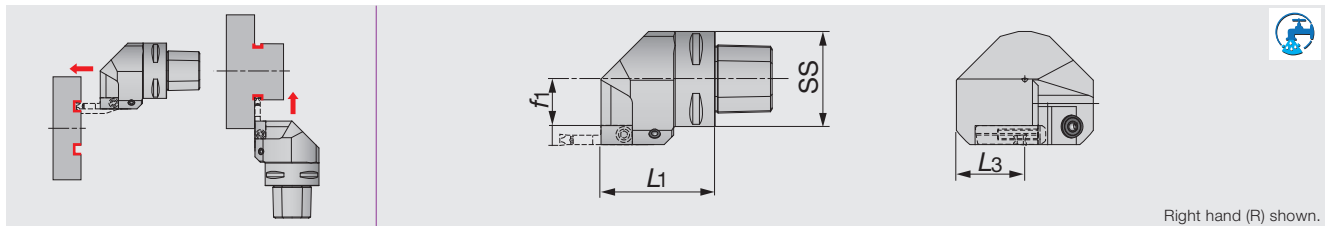
C-CHSR/L

Right hand (R) shown.

Metric	SS	L1	L3	f1	Blade
C4CHSR/L27050N	40	50	36	16.5	CAER/L..., CAFL/R...
C5CHSR/L35060	50	60	36	24.5	CAER/L..., CAFL/R...
C5CHSR/L35060N	50	60	36	24.5	CAER/L..., CAFL/R...
C6CHSR/L45065N	63	65	41	34.5	CAER/L..., CAFL/R...

• The last character of designation is "N": Capable for 7Mpa, coolant pressure.

SPARE PARTS

Designation	Coolant parts	Coolant parts 1	Clamping screw	Wrench
C4CHSR/L27050N	SATZ-M8X1-M3	-	CSHB-6-A	P-4
C5CHSR/L35060	CNZ125	PNZ5	CSHB-6-A	P-4
C5CHSR/L35060N	SATZ-M10X1-M5	-	CSHB-6-A	P-4
C6CHSR/L45065N	SATZ-M10X1-M5	-	CSHB-6-A	P-4

Combination of blade and toolholder

Toolholders	Blade			
	CAER...	CAEL...	CAFR...	CAFL...
C*CHFVR...		●	●	
C*CHFVL...	●			●
C*CHSR...	●			●
C*CHSL...		●	●	

● : Corresponding

CTIFR/L

Toolholders for face / internal face grooving & turning

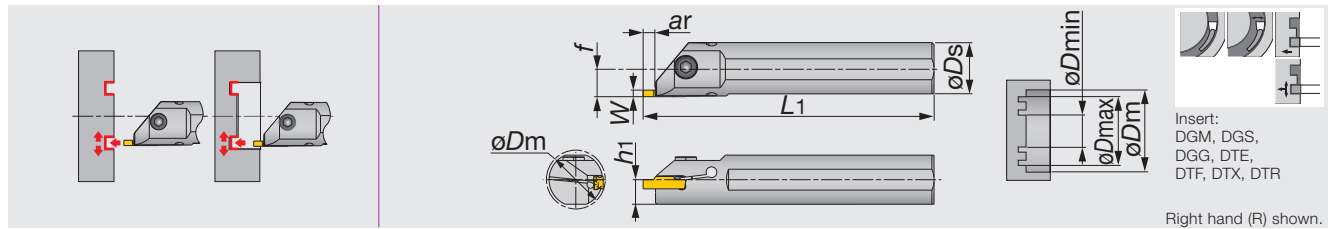

Inch	W	Seat size	ar	øDs	h1	L1 ⁽¹⁾	f
CTIFR/L16-4T05-D17	0.118, 0.157	3, 4	0.217	1.000	0.450	8.000	1.030
CTIFR/L20-4T05-D22	0.118, 0.157	3, 4	0.217	1.250	0.590	10.000	1.280
CTIFR/L16-5T05-D17	0.197, 0.236	5, 6	0.217	1.000	0.450	8.000	1.030
CTIFR/L20-5T05-D22	0.197, 0.236	5, 6	0.217	1.250	0.590	10.000	1.280

Metric	W	Seat size	ar	øDs	h1	L1 ⁽¹⁾	f
CTIFR/L25-4T05-D270	4	3, 4	5.5	25	11.5	200	13.3
CTIFR/L32-4T05-D340	4	3, 4	5.5	32	15	250	16.8
CTIFR/L25-5T05-D270	6	5, 6	5.5	25	11.5	200	13.3
CTIFR/L32-5T05-D340	6	5, 6	5.5	32	15	250	16.8

(1) "f" value is calculated with groove width "W" shown in the table.**

Inch SPARE PARTS

Designation	Clamping screw	Wrench
CTIFR/L16-4T05-D17	CM6X1X16-A	P-5
CTIFR/L20-4T05-D22	CM6X1X20-A	P-5
CTIFR/L16-5T05-D17	CM6X1X16-A	P-5
CTIFR/L20-5T05-D22	CM6X1X20-A	P-5

Insert seat size	Min. bore dia. øDm		Insert seat size	øDmin				øDmax
	øDs = 0.984"	øDs = 1.259"		DGM, DGS, DGG	DTE	DTF / DTX	DTR	
3	1.035	1.311	3	2.126	1.732	0.787	1.614	∞
4	1.055	1.331	4	1.339	1.654	0.709	1.417	∞
5	1.035	1.311	5	1.929	1.969	0.787	2.126	∞
6	1.055	1.331	6	1.811	1.890	0.709	2.126	∞

Metric SPARE PARTS

Designation	Clamping screw	Wrench
CTIFR/L25-4T05-D270	CM6X1X16-A	P-5
CTIFR/L32-4T05-D340	CM6X1X20-A	P-5
CTIFR/L25-5T05-D270	CM6X1X16-A	P-5
CTIFR/L32-5T05-D340	CM6X1X20-A	P-5

Insert seat size	Min. bore dia. øDm		Insert seat size	øDmin				øDmax
	øDs = 25 mm	øDs = 32 mm		DGM, DGS, DGG	DTE	DTF / DTX	DTR	
3	26.3	33.3	3	92	62	19	44	∞
4	26.8	33.8	4	37	42	20	32	∞
5	26.3	33.3	5	60	64	20	48	∞
6	26.8	33.8	6	57	61	23	48	∞

Reference pages

Inserts → C079 - C091, Standard cutting conditions → C091

Grooving Tool

TUNGECUT

Face Grooving

Others

**TUNG**CUT**CTER/L-15A**

Toolholders for machining aluminum wheel, square shank

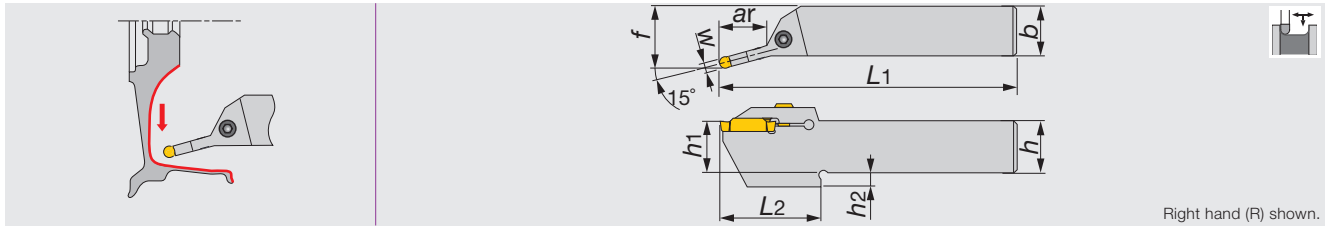

Right hand (R) shown.

Metric	W	Seat size	ar	h	b	L1	f	L2	h1	h2	Insert
CTER/L2525-6T25-15A	6	6	25	25	25	150	32.2	50.5	25	7	DTA...
CTER/L2525-8T30-15A	8	8	30	25	25	150	32.9	55	25	7	DTA...

SPARE PARTS

Designation	Clamping screw	Wrench
CTER/L2525-****-15A	CM6X1X25-A	P-5

TUNGCUT**CGIUR/L-15A**

Boring bars for machining aluminum wheel

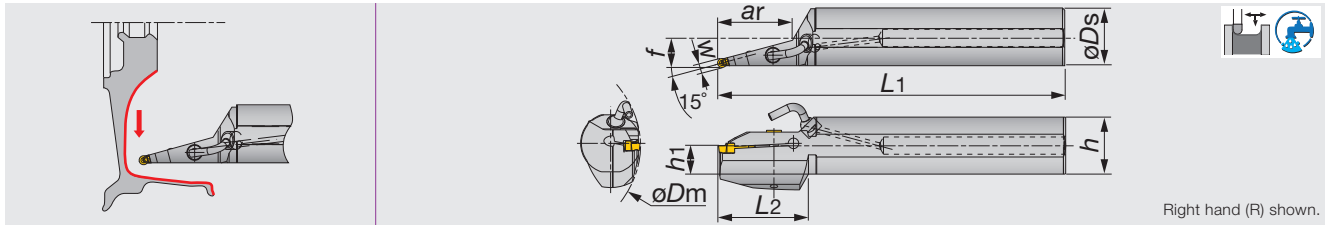

Right hand (R) shown.

Metric	W	øDm	Seat size	ar	øDs	f	L1	L2	h	h1	Insert
CGIUR/L40-6T50-D160-15A	6	160	6	50	40	19.7	320	60	38.5	19	DTA...
CGIUR/L40-8T83-D160-15A	8	160	8	83	40	20.5	320	85	38.5	19	DTA...
CGIUR/L50-6T85-D200-15A	6	200	6	85	50	25.2	350	85	48.5	23.5	DTA...
CGIUR/L50-8T85-D200-15A	8	200	8	85	50	25.9	350	85	48.5	23.5	DTA...

SPARE PARTS

Designation	Clamping screw	Wrench
CGIUR/L*-15A	CM6X1X25-A	P-5

Nozzle parts

Coolant pipe	Coolant nozzle
PNZ5	CNZ125

Reference pages

Inserts → C079 - C091, Standard cutting conditions → C091

External grooving and parting

DGM type (2 corners)
SGM type (1 corner)



Page C083

1st choice for external grooving and parting off

- Smooth chip evacuation
- Well-designed edge with high strength
- Handed insert available
- $W = 0.079'' - 0.315''$

Standard feed

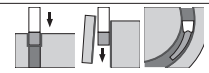
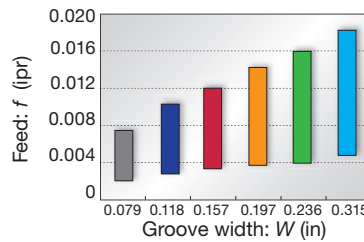

DGS type (2 corners)
SGS type (1 corner)



Page C084, C085

Lower cutting force and superior sharpness

- Unique-designed edge and chipbreaker
- Handed insert available
- $W = 0.055'' - 0.236''$

Standard feed

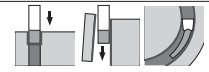
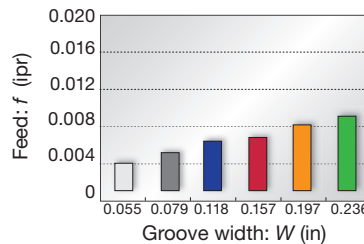

External and face grooving, and turning

DTE type (2 corners)



Page C086, C087

For general purpose

- Unique chipbreaker makes chips shorter
- Molded and ground insert available
- $W = 0.104'' - 0.315''$

Standard feed and DoC

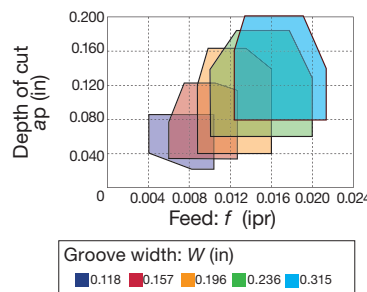

Standard feed

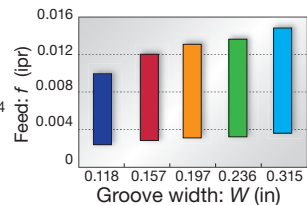

External and face grooving

DGG type (2 corners)



Page C087

For non-ferrous materials and titanium

- Chipbreaker with low cutting force
- Sharp cutting edge that prevents vibration and delivers fine surface finish
- $W = 0.079'' - 0.236''$

Standard feed

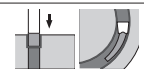
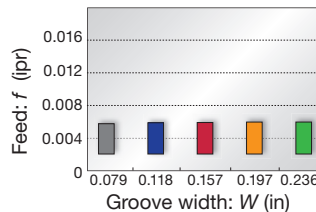



External, internal and face grooving, and turning

DTX type (2 corners) Multi-functional type

Well balanced sharpness and strength
Multi functional insert
 $W = 0.118" - 0.236"$

Page C087

Standard feed and DoC

Standard feed

External grooving

DGE type (2 corners) For high accurate and shallow groove

Excellent chip control
 $W = 0.039" - 0.085"$

Page C086

Standard feed

Profiling and undercutting

DTR type (2 corners) Full radius type

Molded
Ground

Excellent chip control
Molded and ground insert available
 $W = 0.118" - 0.315"$

Page C089, C090

Standard feed and DoC

DTIU type (2 corners) Full radius type

Excellent chip control
For undercutting
 $W = 0.118" - 0.236"$

Page C090

Standard feed and DoC

Internal grooving and turning

DTI type (2 corners)

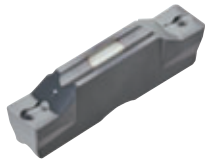

Page C088

1st choice for internal grooving
 Unique chipbreaker makes chips shorter
 Molded and ground insert available
 $W = 0.118'' - 0.315''$

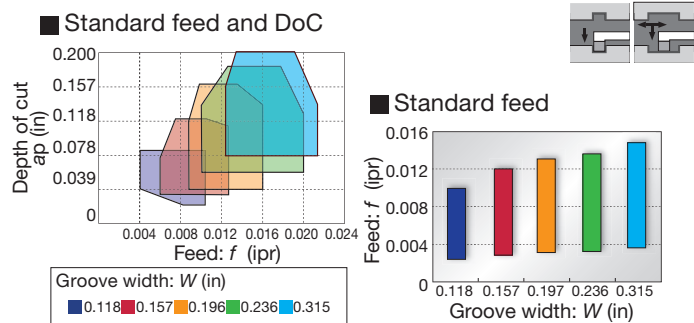

Small diameter internal grooving

DGIM type (2 corners)



Page C089

2 mm insert width only (For general purpose)
 Unique chipbreaker for excellent chip control
 Excellent fracture resistance due to optimum land on the cutting edge
 For general applications on steels & stainless steels
 $W = 0.079''$

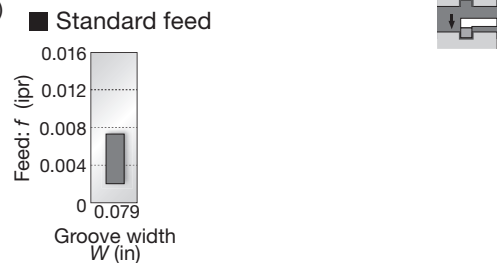

DGIS type (2 corners)



Page C089

2 mm insert width only (Lower cutting force)
 Low cutting force due to a unique land geometry
 Applicable for low carbon steels & stainless steels
 $W = 0.079''$

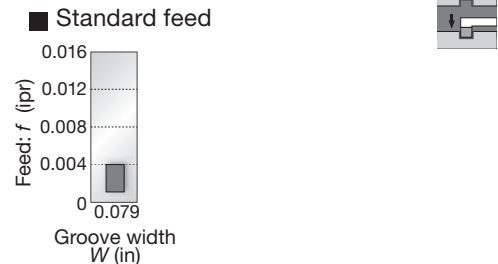

Face grooving and turning

DTF type (2 corners)



Page C088

1st choice for face grooving
 Unique chipbreaker makes chips shorter
 Handed insert
 $W = 0.118'' - 0.157''$

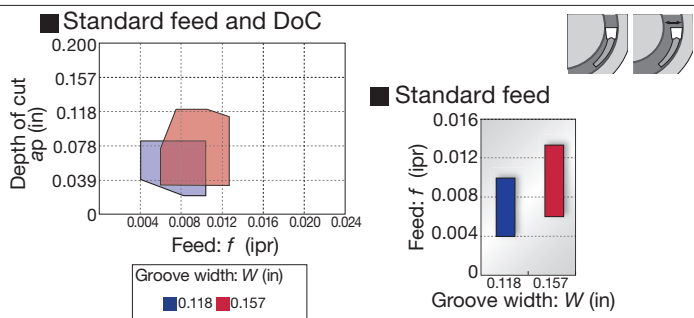



Aluminum wheel machining

**DTA type
(2 corners)**



Page C090

Full radius type

Excellent chip control

For aluminum wheel profiling

Ground insert

$W = 0.236'' - 0.315''$

■ Standard feed and DoC

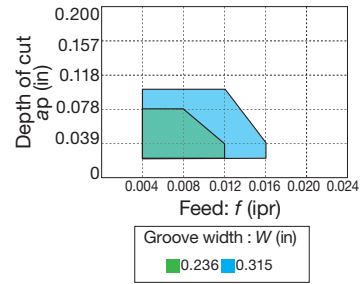

External grooving of hardened steels

**SGN-CBN type
(1 corner)**



Page C091

For hardened steel cutting

Optimum cutting edge shape for grooving of hardened steels

High tolerance width for finishing ($W = \pm 0.001''$)

$W = 0.079'' - 0.157''$

■ Standard feed

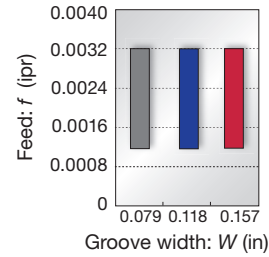

INSERT

DGM

External grooving and parting off, 2 corner

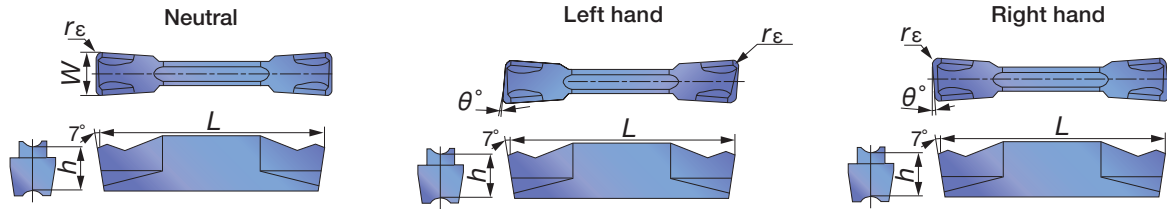

Designation	Insert seat size	W±0.05 (mm)	W±0.002 (in)	rε (in)	Coated								Cermet		L (in)	h (in)	θ°		
					T9125		AH7025		AH725		AH905		GH130					NS9530	
					R	L	R	L	R	L	R	L	R	L				R	L
DGM2-020	2	2	0.079	0.008	●		●		●			●	●	0.787	0.197	0			
DGM2-020-6R/L	2	2	0.079	0.008			●	●	●	●		●	●	0.787	0.197	6			
DGM2-020-8R/L	2	2	0.079	0.008			●	●	●	●		●	●	0.787	0.197	8			
DGM2-020-15R/L	2	2	0.079	0.008			●	●	●	●		●	●	0.787	0.197	15			
DGM2-002-15R/L	2	2	0.079	0.0008			●	●				●	●	0.772	0.197	15			
DGM3-020	3	3	0.118	0.008	●		●		●			●	●	0.787	0.197	0			
DGM3-020-6R/L	3	3	0.118	0.008			●	●				●	●	0.787	0.197	6			
DGM3-002-6R/L	3	3	0.118	0.0008			●	●				●	●	0.772	0.197	6			
DGM3-020-15R/L	3	3	0.118	0.008			●	●				●	●	0.787	0.197	15			
DGM4-030	4	4	0.157	0.012	●		●		●			●	●	0.787	0.197	0			
DGM4-030-4R/L	4	4	0.157	0.012			●	●				●	●	0.787	0.197	4			
DGM4-030-15R/L	4	4	0.157	0.012			●	●				●	●	0.787	0.197	15			
DGM5-030	5	5	0.197	0.012	●		●		●			●	●	0.984	0.217	0			
DGM5-030-4R	5	5	0.197	0.012			●					●		0.787	0.217	4			
DGM6-030	6	6	0.236	0.012	●		●		●			●	●	0.984	0.217	0			
DGM8-040	8	8	0.315	0.016	●		●					●		1.181	0.264	0			

● : Line up

SGM

External deep grooving and parting off, 1 corner

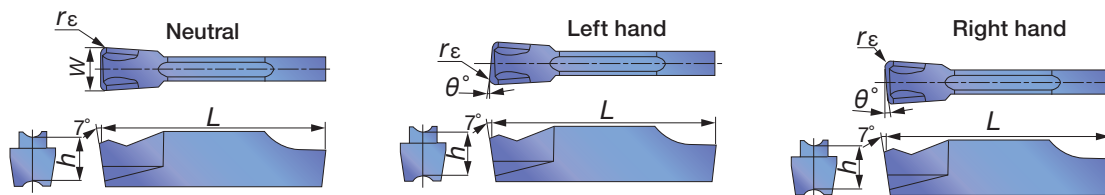

Designation	Insert seat size	W±0.05 (mm)	W±0.002 (in)	rε (in)	Coated				L (in)	h (in)	θ°
					AH725		GH130				
					R	L	R	L			
SGM2-020	2	2	0.079	0.008	●		●		0.787	0.197	0
SGM2-020-6R/L	2	2	0.079	0.008	●	●	●	●	0.787	0.197	6
SGM3-020	3	3	0.118	0.008	●		●		0.787	0.197	0
SGM3-020-6R/L	3	3	0.118	0.008	●	●	●	●	0.787	0.197	6
SGM3-020-15R/L	3	3	0.118	0.008	●	●	●	●	0.787	0.197	15
SGM4-030	4	4	0.157	0.012	●		●		0.787	0.197	0
SGM4-030-4R/L	4	4	0.157	0.012	●	●	●	●	0.787	0.197	4
SGM5-030	5	5	0.197	0.012	●		●		0.984	0.217	0
SGM6-030	6	6	0.236	0.012	●		●		0.984	0.217	0

● : Line up



DGS

External grooving and parting off, 2 corner

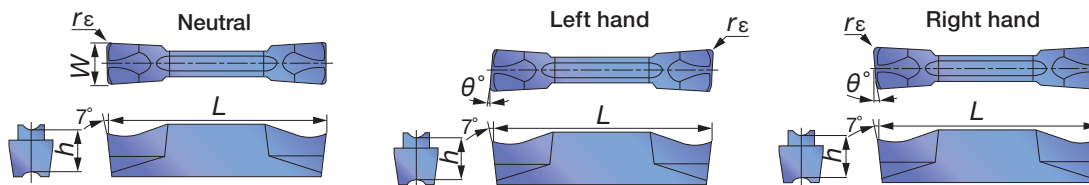

Designation	Insert seat size	W±0.05 (mm)	W±0.002 (in)	rε (in)	Coated								Cermet		L (in)	h (in)	θ°
					T9125		AH7025		AH725		GH130		NS9530				
					R	L	R	L	R	L	R	L	R	L			
DGS1.4-016	1	1.4	0.055	0.006					●		●				0.630	0.169	0
DGS2-020	2	2	0.079	0.008	●		●		●		●		●		0.787	0.197	0
DGS2-020-6R/L	2	2	0.079	0.008					●	●	●	●			0.787	0.197	6
DGS2-002-6R/L	2	2	0.079	0.0008					●	●	●	●			0.772	0.197	6
DGS2-020-15R/L	2	2	0.079	0.008					●	●	●	●			0.787	0.197	15
DGS2-002-15R/L	2	2	0.079	0.0008					●	●	●	●			0.772	0.197	15
DGS3-020	3	3	0.118	0.008	●		●		●		●		●		0.787	0.197	0
DGS3-020-6R/L	3	3	0.118	0.008					●	●	●	●			0.787	0.197	6
DGS3-002-6R/L	3	3	0.118	0.0008					●	●	●	●			0.772	0.197	6
DGS3-020-15R/L	3	3	0.118	0.008					●	●	●	●			0.787	0.197	15
DGS3-002-15R/L	3	3	0.118	0.0008					●	●	●	●			0.772	0.197	15
DGS4-030	4	4	0.157	0.012	●		●		●		●		●		0.787	0.197	0
DGS4-030-4R/L	4	4	0.157	0.012					●	●	●	●			0.787	0.197	4
DGS5-030	5	5	0.197	0.012	●				●		●		●		0.984	0.217	0
DGS6-030	6	6	0.236	0.012	●				●		●		●		0.984	0.217	0

● : Line up

Caution

Designation	øDmax (in)	Designation	øDmax (in)
DGM2-002-15R/L	1.102	DGS2-002-15R/L	1.102
DGM3-002-15R/L	1.141	DGS3-002-15R/L	1.141
DGM4-030-15R/L	1.181	SGS3-020-15R/L	4.055
SGM3-020-15R/L	4.055	SGS3-002-15R/L	1.338

The tool will interfere with the workpiece when grooving larger diameter than øDmax.

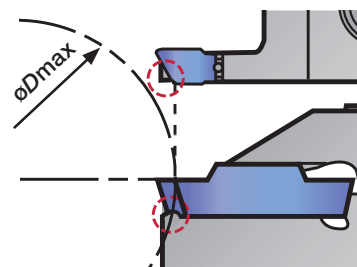

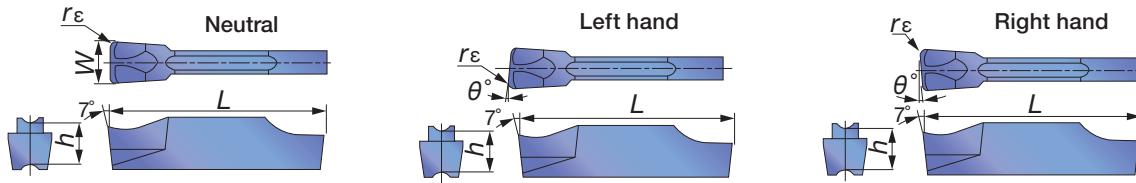

Designation	Insert seat size	W±0.05 (mm)	W±0.002 (in)	rε (in)	Coated				L (in)	h (in)	θ°
					AH725		GH130				
					R	L	R	L			
SGS2-020	2	2	0.079	0.008	●		●		0.787	0.197	0
SGS2-020-6R/L	2	2	0.079	0.008	●	●	●	●	0.787	0.197	6
SGS2-020-15R/L	2	2	0.079	0.008	●	●	●	●	0.787	0.197	15
SGS3-020	3	3	0.118	0.008		●		●	0.787	0.197	0
SGS3-020-6R/L	3	3	0.118	0.008	●	●	●	●	0.787	0.197	6
SGS3-002-6R/L	3	3	0.118	0.0008	●	●	●	●	0.780	0.197	6
SGS3-020-15R/L	3	3	0.118	0.008	●	●	●	●	0.787	0.197	15
SGS3-002-15R/L	3	3	0.118	0.0008	●	●	●	●	0.787	0.197	15
SGS4-030	4	4	0.157	0.012		●		●	0.787	0.197	0
SGS5-030	5	5	0.197	0.012		●		●	0.984	0.217	0
SGS6-030	6	6	0.236	0.012		●		●	0.984	0.217	0

● : Line up



DGE

External grooving (for high-precision machining)

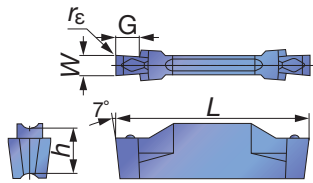

Designation	Insert seat size	W±0.02 (mm)	W±0.001 (in)	rε (in)	Coated		Cermet	G (in)	L (in)	h (in)
					AH725	GH130	NS9530			
DGE100-000	2	1	0.039	0	●	●	●	0.100	0.787	0.197
DGE130-000	2	1.3	0.051	0	●	●	●	0.100	0.787	0.197
DGE160-010	2	1.6	0.063	0.004	●	●	●	0.100	0.787	0.197
DGE185-010	2	1.85	0.073	0.004	●	●	●	0.140	0.787	0.197
DGE215-015	2	2.15	0.085	0.006	●	●	●	0.140	0.787	0.197

● : Line up

Caution

øDmax is limited as shown in the picture to the right according to the groove depth, G.D. Please refer to the following table.

G.D = Groove depth

Designation	Max. groove depth (in)	øDmax (in)				
		G.D. = 0.039	G.D. = 0.059	G.D. = 0.078	G.D. = 0.098	G.D. = 0.118
DGE100-000	0.078	∞	0.73	0.45	-	-
DGE130-000					-	-
DGE160-010					-	-
DGE185-010	0.118	∞	0.73	0.45	0.35	0.28
DGE215-015					0.35	0.28

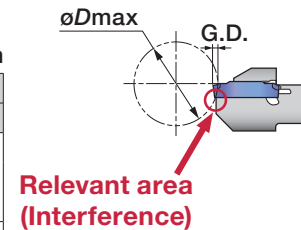

Relevant area (Interference)

DTE

External, grooving and turning (for high-precision machining)

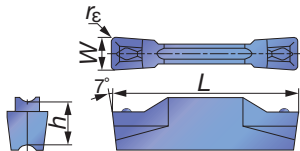

Designation	Insert seat size	W±0.02 (mm)	W±0.001 (in)	rε (in)	Coated				Cermet	L (in)	h (in)
					T9125	AH7025	AH725	GH130	NS9530		
DTE265-015	3	2.65	0.104	0.006	●	●	●	●	●	0.787	0.197
DTE300-020	3	3	0.118	0.008	●	●	●	●	●	0.787	0.197
DTE300-040	3	3	0.118	0.016	●	●	●	●	●	0.787	0.197
DTE315-015	3	3.15	0.124	0.006	●	●	●	●	●	0.787	0.197
DTE400-040	4	4	0.157	0.016	●	●	●	●	●	0.787	0.197
DTE400-080	4	4	0.157	0.031	●	●	●	●	●	0.787	0.197
DTE415-015	4	4.15	0.163	0.006	●	●	●	●	●	0.787	0.197
DTE478-055	5	4.78	0.188	0.022	●	●	●	●	●	0.984	0.217
DTE500-040	5	5	0.197	0.016	●	●	●	●	●	0.984	0.217
DTE500-080	5	5	0.197	0.031	●	●	●	●	●	0.984	0.217
DTE515-015	5	5.15	0.203	0.006	●	●	●	●	●	0.984	0.217
DTE600-080	6	6	0.236	0.031	●	●	●	●	●	0.984	0.217
DTE600-120	6	6	0.236	0.047	●	●	●	●	●	0.984	0.217
DTE800-080	8	8	0.315	0.031	●	●	●	●	●	1.181	0.264
DTE800-120	8	8	0.315	0.047	●	●	●	●	●	1.181	0.264

● : Line up

DTE

External, grooving and turning

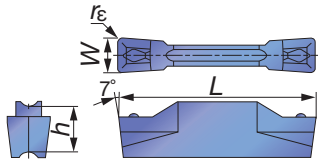

Designation	Insert seat size	W±0.05 (mm)	W±0.001 (in)	rε (in)	Coated				Cermet NS9530	L (in)	h (in)
					T9125	AH7025	AH725	GH130			
DTE3-040	3	3	0.118	0.016	●	●	●	●	●	0.787	0.197
DTE4-040	4	4	0.157	0.016	●	●	●	●	●	0.787	0.197

● : Line up

DGG

External and face grooving (for high-precision machining)

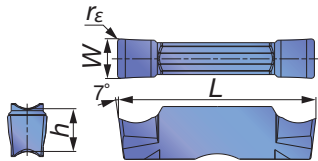

Designation	Insert seat size	W±0.02 (mm)	W±0.001 (in)	rε (in)	Cermet	Uncoated	L (in)	h (in)
					NS9530	KS05F		
DGG200-020	2	2	0.079	0.008	●	●	0.787	0.197
DGG300-020	3	3	0.118	0.008	●	●	0.787	0.197
DGG400-040	4	4	0.157	0.016	●	●	0.787	0.197
DGG500-040	5	5	0.197	0.016	●	●	0.984	0.217
DGG600-040	6	6	0.236	0.016	●	●	0.984	0.217

● : Line up

DTX

External, internal, face grooving and turning

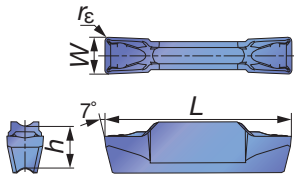

Designation	Insert seat size	W±0.05 (mm)	W±0.002 (in)	rε (in)	Coated				Cermet NS9530	L (in)	h (in)
					T9125	AH7025	AH725	GH130			
DTX3-030	3	3	0.118	0.012	●	●	●	●	●	0.787	0.197
DTX4-040	4	4	0.157	0.016	●	●	●	●	●	0.787	0.197
DTX5-040	5	5	0.197	0.016	●	●	●	●	●	0.984	0.217
DTX6-080	6	6	0.236	0.031			●	●		0.984	0.217

● : Line up



DTF

Face grooving and turning

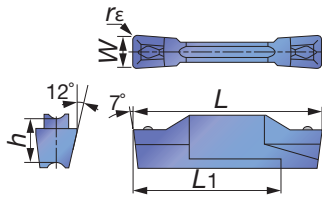

Designation	Insert seat size	W±0.05 (mm)	W±0.002 (in)	rε (in)	Coated				Cermet		L (in)	h (in)	L1 (in)		
					T9125		AH725		GH130					NS9530	
					R	L	R	L	R	L				R	L
DTF3-040-R/L	3	3	0.118	0.016	●	●	●	●	●	●	0.787	0.197	0.630		
DTF4-040-R/L	4	4	0.157	0.016	●	●	●	●	●	●	0.787	0.197	0.630		

● : Line up

DTI

Internal grooving and turning (for high-precision machining)

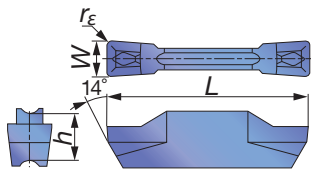

Designation	Insert seat size	W±0.02 (mm)	W±0.001 (in)	rε (in)	Coated				L (in)	h (in)
					T9125	AH725	GH130	NS9530		
DTI300-040	3	3	0.118	0.016	●	●	●	●	0.787	0.197
DTI400-040	4	4	0.157	0.016	●	●	●	●	0.787	0.197
DTI400-080	4	4	0.157	0.031	●	●	●	●	0.787	0.197
DTI500-040	5	5	0.197	0.016	●	●	●	●	0.984	0.217
DTI500-080	5	5	0.197	0.031	●	●	●	●	0.984	0.217
DTI600-080	6	6	0.236	0.031	●	●	●	●	0.984	0.217
DTI600-120	6	6	0.236	0.047	●	●	●	●	0.984	0.217
DTI800-080	8	8	0.315	0.031	●	●	●	●	1.181	0.264
DTI800-120	8	8	0.315	0.047	●	●	●	●	1.181	0.264

● : Line up

DTI

Internal grooving and turning

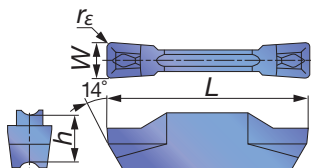

Designation	Insert seat size	W±0.05 (mm)	W±0.002 (in)	rε (in)	Coated				Cermet NS9530	L (in)	h (in)
					T9125	AH7025	AH725	GH130			
DTI3-040	3	3	0.118	0.016	●	●	●	●	●	0.016	0.197
DTI4-040	4	4	0.118	0.016	●	●	●	●	●	0.016	0.197

● : Line up

DGIM

Small diameter internal grooving

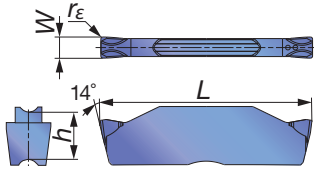

Designation	Insert seat size	W±0.05 (mm)	W±0.002 (in)	rε (in)	Coated			Cermet	L (in)	h (in)
					T9125	AH725	GH130	NS9530		
DGIM2-020	2	2	0.079	0.008	●	●	●	●	0.787	0.197

● : Line up

DGIS

Small diameter internal grooving

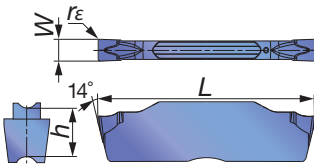

Designation	Insert seat size	W±0.05 (mm)	W±0.002 (in)	rε (in)	Coated			Cermet	L (in)	h (in)
					T9125	AH725	GH130	NS9530		
DGIS2-020	2	2	0.079	0.008	●	●	●	●	0.787	0.197

● : Line up

DTR

Profiling and undercutting (for high-precision machining)

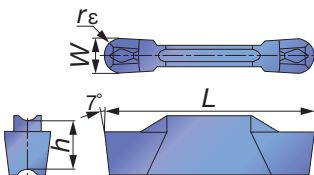

Designation	Insert seat size	W±0.02 (mm)	W±0.001 (in)	rε (in)	Coated			Cermet	L (in)	h (in)
					T9125	AH725	GH130	NS9530		
DTR300-150	3	3	0.118	0.059	●	●	●	●	0.787	0.197
DTR400-200	4	4	0.157	0.079	●	●	●	●	0.787	0.197
DTR478-239	5	4.78	0.188	0.094	●	●	●	●	0.984	0.217
DTR500-250	5	5	0.197	0.098	●	●	●	●	0.984	0.217
DTR600-300	6	6	0.236	0.118	●	●	●	●	0.984	0.217

● : Line up



Grooving Tool

TUNGSCUT



DTR

Profiling and undercutting

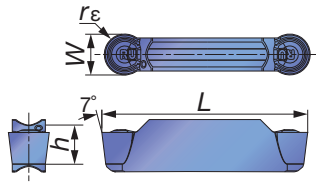

Designation	Insert seat size	W±0.05 (mm)	W±0.002 (in)	rε (in)	Coated					Cermet NS9530	L (in)	h (in)
					T9125	AH7025	AH725	AH905	GH130			
DTR3-150	3	3	0.118	0.059	●	●	●	●	●	●	0.787	0.197
DTR4-200	4	4	0.157	0.079	●	●	●	●	●	●	0.787	0.197
DTR5-250	5	5	0.197	0.098	●	●	●	●	●	●	0.984	0.217
DTR6-300	6	6	0.236	0.118	●	●	●		●		0.984	0.217
DTR8-400	8	8	0.315	0.157	●		●		●		1.181	0.264

● : Line up

DTIU

Profiling and undercutting (for high-precision machining)

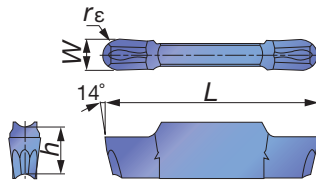

Designation	Insert seat size	W±0.02 (mm)	W±0.001 (in)	rε (in)	Coated		L (in)	h (in)
					AH725	GH130		
DTIU300-150	3	3	0.118	0.059	●	●	0.787	0.197
DTIU400-200	4	4	0.157	0.079	●	●	0.787	0.197
DTIU500-250	5	5	0.197	0.098	●	●	0.984	0.217
DTIU600-300	6	6	0.236	0.118	●	●	0.984	0.217

● : Line up

DTA

Aluminum wheel machining (for high-precision machining)

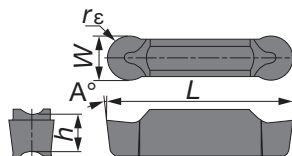

Designation	Insert seat size	W±0.02 (mm)	W±0.001 (in)	rε (in)	Uncoated	L (in)	h (in)	A
					TH10			
DTA600-300	6	6	0.236	0.118	●	0.984	0.217	7°
DTA800-400	8	8	0.315	0.157	●	1.181	0.264	10°

● : Line up

SGN

External grooving of hardened steels

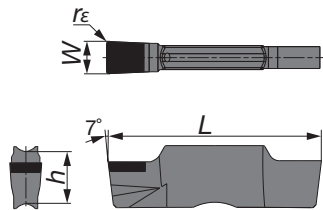

Designation	Insert seat size	W±0.025 (mm)	W±0.001 (in)	rE (in)	CBN	L (in)	h (in)
					BX360		
SGN200-020	2	2	0.079	0.008	●	0.787	0.197
SGN300-020	3	3	0.118	0.008	●	0.787	0.197
SGN400-020	4	4	0.157	0.008	●	0.787	0.197

● : Line up

STANDARD CUTTING CONDITIONS

ISO	Workpiece material	Hardness	Priority	Grade	Cutting speed Vc (sfm)
P	Steel (1045, 4135, etc.)	< 300 HB	First choice	AH7025, AH725	160 - 600
		< 300 HB	Priority for wear resistance	T9125	260 - 660
		< 300 HB	Priority for impact resistance	GH130	160 - 400
		< 300 HB	Priority for surface finish	NS9530	260 - 720
M	Stainless steel (304SS, 316SS, 17-4 PH, etc.)	< 200 HB	First choice	AH7025, AH725	160 - 400
		< 200 HB	Priority for impact resistance	GH130	160 - 400
K	Gray cast iron (Class 25, Class 30, etc.)	-	First choice	GH130	160 - 600
	Ductile cast iron (60-40-18, 60-55-06, etc.)	-	First choice	GH130	160 - 400
N	Aluminum alloys (Si < 12%)	-	First choice	TH10	330 - 1650
S	Titanium alloys (Ti-6Al-4V, etc.)	< HRC 40	First choice	AH905	60 - 260
		< HRC 40	Priority for impact resistance	AH7025, AH725	60 - 260
H	Hardened material	> HRC 50	First choice	BX360	260 - 500



Wide variety of tools dramatically reduce set up time

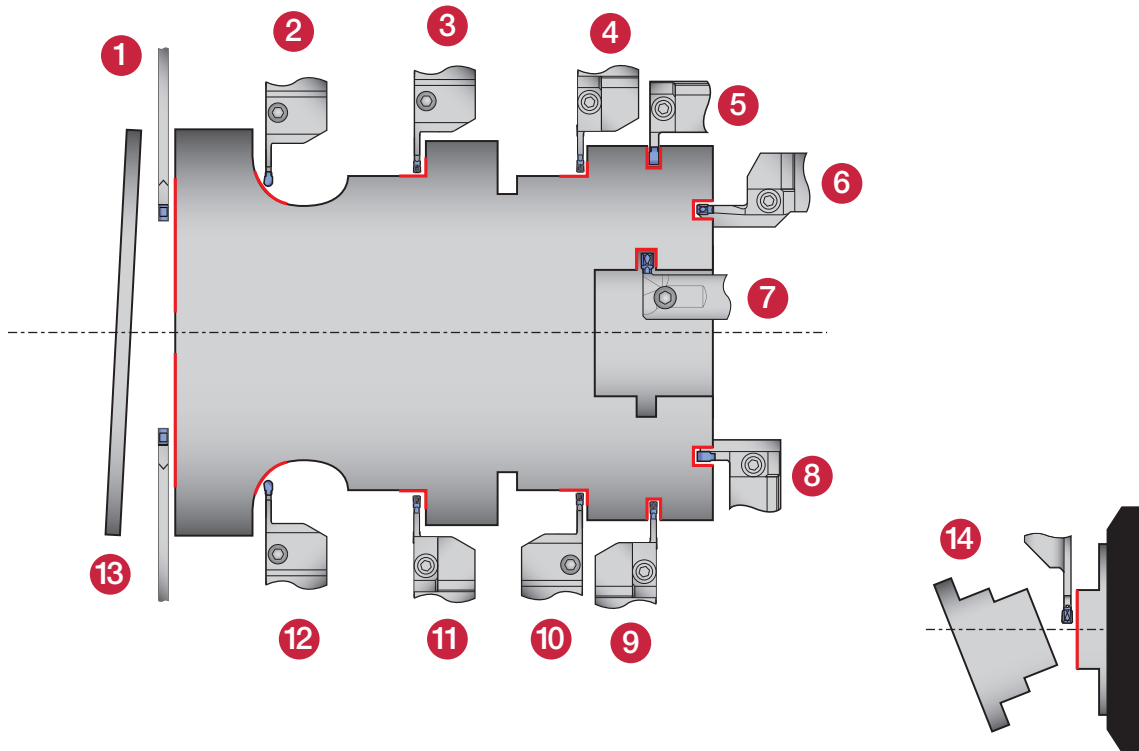

External



Internal



Face Grooving



Parting-off

Others

1 CCH

1 corner
 $W = 0.118" - 0.197"$
 (3 - 5 mm)
 Max. parting Dia.: 4.724"
 (120 mm)
 Shank size: 0.750" - 1.26"
 (20 - 32 mm)

Page C103

2 CGSSR/L-D

1 corner
 Monoblock type
 $W = 0.118" - 0.197"$
 (3 - 5 mm)
 $ar = 0.866" - 1.000"$
 (22 - 25 mm)
 Shank size: 0.625" - 1.000"
 (16 - 25 mm)

Page C102

3 CGSSR/L

1 corner
 Monoblock type
 $W = 0.080" - 0.197"$
 (2 - 5 mm)
 $ar = 0.472" - 0.630"$
 (12 - 16 mm)
 Shank size: 0.625" - 1.000"
 (16 - 25 mm)

Page C101

4 CGWSR/L-G

1 corner
 Adaptor type
 $W = 0.080" - 0.197"$
 (2 - 5 mm)
 $ar = 0.472" (12 mm)$
 Shank size: 0.750" - 1.000"
 (20 - 25 mm)

Page C100

5 CGWTR/L-G

1 corner
 Adaptor type
 $W = 0.080" - 0.197"$
 (2 - 5 mm)
 $ar = 0.472" (12 mm)$
 Shank size: 0.750" - 1.000"
 (20 - 25 mm)

Page C101

6 CGWSR/L *S/D*L/R

1 corner
 Adaptor type
 $W = 0.118" - 0.197"$
 (3 - 5 mm)
 $ar = 0.394" - 0.866"$
 (10 - 22 mm)
 Shank size: 0.750" - 1.000"
 (20 - 25 mm)

Page C106

7 CGTR/L

1 corner
 Monoblock type
 $W = 0.118" - 0.197"$
 (3 - 5 mm)
 $ar = 0.138" - 0.236"$
 (3.5 - 6 mm)
 Shank size: 1.000" - 1.575"
 (25 - 40 mm)

Page C111

8 CGWTR/L *S/D*L/R

1 corner
 Adaptor type
 $W = 0.118" - 0.197"$
 (3 - 5 mm)
 $ar = 0.394" - 0.866"$
 (10 - 22 mm)
 Shank size: 0.750" - 1.000"
 (20 - 25 mm)

Page C108

9 CGWSR/L-WG

2 corner
 Adaptor type
 $W = 0.118" - 0.197"$
 (3 - 5 mm)
 $ar = 0.472" - 0.512"$
 (12 - 13 mm)
 Shank size: 0.750" - 1.000"
 (20 - 25 mm)

Page C094

10 CGWSR/L-W

2 corner
 Monoblock type
 $W = 0.118" - 0.197"$
 (3 - 5 mm)
 $ar = 0.472" - 0.512"$
 (12 - 13 mm)
 Shank size: 0.625" - 1.000"
 (16 - 25 mm)

Page C093

11 CGWSR/L -WG-L

2 corner
 Adaptor type
 $W = 0.080" - 0.197"$
 (2 - 5 mm)
 $ar = 0.591" - 0.846"$
 (15 - 21.5 mm)
 Shank size: 0.750" - 1.000"
 (20 - 25 mm)

Page C094

12 CGWSR/L -W-L

2 corner
 Monoblock type
 $W = 0.118" - 0.197"$
 (3 - 5 mm)
 $ar = 0.591" - 0.846"$
 (15 - 21.5 mm)
 Shank size: 0.625" - 1.000"
 (16 - 25 mm)

Page C093

13 CCH-W

2 corner
 $W = 0.080" - 0.197"$
 (2 - 5 mm)
 Max. parting Dia.: 1.654"
 (42 mm)
 Shank size: 0.750" - 1.26"
 (20 - 32 mm)

Page C097

14 JCGSSR/L

1 corner
 For swiss type machine
 $W = 0.080" (2 mm)$
 Max. parting Dia.: 1.260"
 (32 mm)
 Shank size: 0.394" - 0.625"
 (10 - 16 mm)

Page C102

MY-T SERIES

CGWSR/L-W

External toolholders for grooving & parting & turning

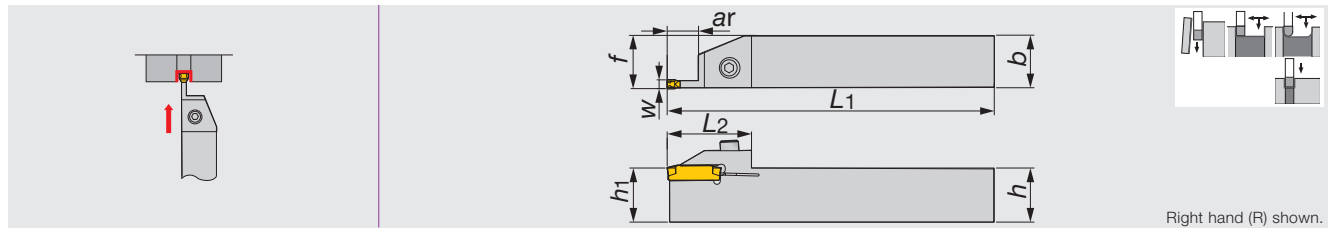

Metric	W	ar	h	b	L1	L2	h1	f	Insert
CGWSR/L1616-W30	3	12	16	16	125	34	16	16.4	WG*30, WGE30R/L
CGWSR/L2020-W30	3	12	20	20	150	34	20	20.4	WG*30, WGE30R/L
CGWSR/L2525-W30	3	12	25	25	150	34	25	25.4	WG*30, WGE30R/L
CGWSR/L2020-W40	4	13	20	20	150	39	20	20.4	WG*40, WGE40R/L
CGWSR/L2525-W40	4	13	25	25	150	39	25	25.4	WG*40, WGE40R/L
CGWSR/L2020-W50	5	13	20	20	150	39	20	20.4	WG*50, WGE50R/L
CGWSR/L2525-W50	5	13	25	25	150	39	25	25.4	WG*50, WGE50R/L

SPARE PARTS

Designation	Clamping screw	Wrench
CGWSR/L***-W...	CHHM5-18	P-4

MY-T SERIES

CGWSR/L-W-L

External toolholders for deep grooving & parting & turning

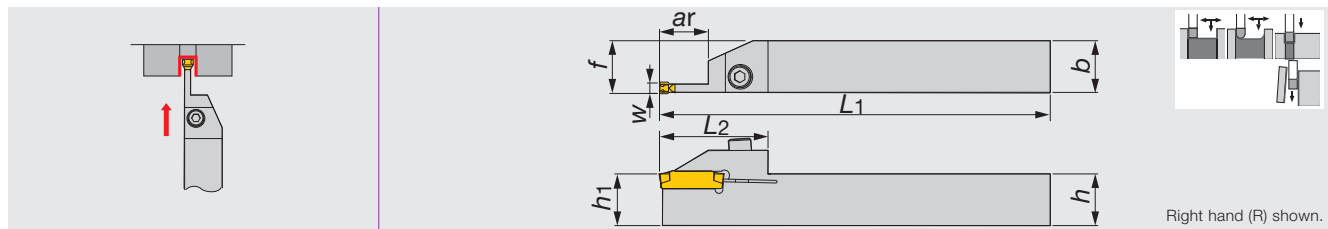

Metric	W	ar	h	b	L1	L2	h1	f	Insert
CGWSR/L1616-W20-L	2	15	16	16	125	37	16	16.2	WGE20, WGE20R/L
CGWSR/L2020-W20-L	2	15	20	20	150	37	20	20.2	WGE20, WGE20R/L
CGWSR/L2525-W20-L	2	15	25	25	150	37	25	25.2	WGE20, WGE20R/L
CGWSR/L1616-W30-L	3	16.5, 17.5	16	16	125	37	16	16.4	WG*30, WGE30R/L
CGWSR/L2020-W30-L	3	16.5, 17.5	20	20	150	37	20	20.4	WG*30, WGE30R/L
CGWSR/L2525-W30-L	3	16.5, 17.5	25	25	150	37	25	25.4	WG*30, WGE30R/L
CGWSR/L2020-W40-L	4	21, 21.5	20	20	150	42	20	20.4	WG*40, WGE40R/L
CGWSR/L2525-W40-L	4	21, 21.5	25	25	150	42	25	25.4	WG*40, WGE40R/L
CGWSR/L2020-W50-L	5	21	20	20	150	42	20	20.4	WG*50, WGE50R/L
CGWSR/L2525-W50-L	5	21	25	25	150	42	25	25.4	WG*50, WGE50R/L

SPARE PARTS

Designation	Clamping screw	Wrench
CGWSR/L***-W**-L	CHHM5-18	P-4

Reference pages

Inserts → C098 - C099, Standard cutting conditions → C099



Grooving Tool

MY-T SERIES

MY-T SERIES

CGWSR/L-WG

External toolholders for grooving & parting & turning

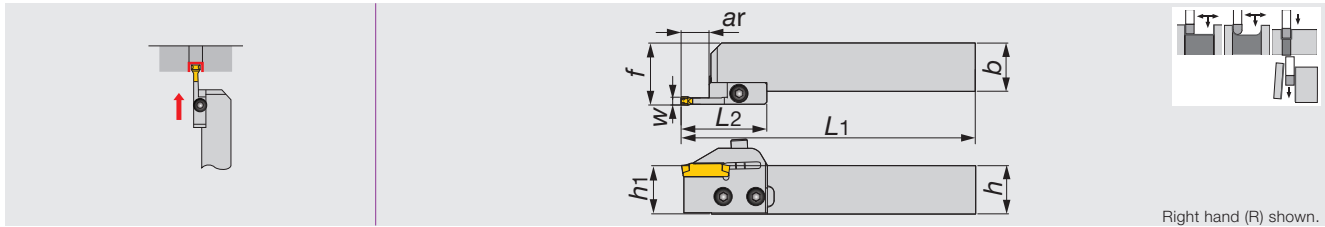

Metric	W	ar	h	b	L1	L2	h1	f	Insert	Shank	Blade*
CGWSR/L2020-W30GR/L	3	12	20	20	150.5	43.5	20	26.9	WG*30, WGE30R/L	CGWSR/L2020	W30GR/L
CGWSR/L2525-W30GR/L	3	12	25	25	150.5	43.5	25	31.9	WG*30, WGE30R/L	CGWSR/L2525	W30GR/L
CGWSR/L2020-W40GR/L	4	13	20	20	151.5	44.5	20	26.9	WG*40, WGE40R/L	CGWSR/L2020	W40GR/L
CGWSR/L2525-W40GR/L	4	13	25	25	151.5	44.5	25	31.9	WG*40, WGE40R/L	CGWSR/L2525	W40GR/L
CGWSR/L2020-W50GR/L	5	13	20	20	151.5	44.5	20	26.9	WG*50, WGE50R/L	CGWSR/L2020	W50GR/L
CGWSR/L2525-W50GR/L	5	13	25	25	151.5	44.5	25	31.9	WG*50, WGE50R/L	CGWSR/L2525	W50GR/L

• When using a right or left hand blade set, the right hand blade set is used with right hand shank and the left hand blade set is used with left hand shank.
 * Blade sold separately.

SPARE PARTS

Designation	Clamping screw	Blade screw	Wrench
CGWSR/L***-W**GR/L	CHHM5-18	CSHB-6	P-4

MY-T SERIES

CGWSR/L-WG-L

External toolholders for deep grooving & parting & turning



External

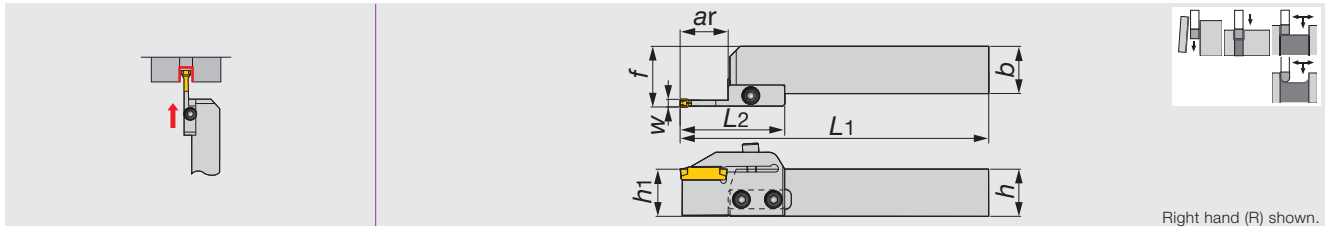

Metric	W	ar	h	b	L1	L2	h1	f	Insert	Shank	Blade*
CGWSR/L2020-W20GR/L-L	2	15	20	20	153.5	46.5	20	26.7	WGE20, WGE20R/L	CGWSR/L2020	W20GR/L-L
CGWSR/L2525-W20GR/L-L	2	15	25	25	153.5	46.5	25	31.7	WGE20, WGE20R/L	CGWSR/L2525	W20GR/L-L
CGWSR/L2020-W30GR/L-L	3	16.5 - 17.5	20	20	157.5	50.5	20	26.9	WG*30, WGE30R/L	CGWSR/L2020	W30GR/L-L
CGWSR/L2525-W30GR/L-L	3	16.5 - 17.5	25	25	157.5	50.5	25	31.9	WG*30, WGE30R/L	CGWSR/L2525	W30GR/L-L
CGWSR/L2020-W40GR/L-L	4	21 - 21.5	20	20	162.5	55.5	20	26.9	WG*40, WGE40R/L	CGWSR/L2020	W40GR/L-L
CGWSR/L2525-W40GR/L-L	4	21 - 21.5	25	25	162.5	55.5	25	31.9	WG*40, WGE40R/L	CGWSR/L2525	W40GR/L-L
CGWSR/L2020-W50GR/L-L	5	21	20	20	162.5	55.5	20	26.9	WG*50, WGE50R/L	CGWSR/L2020	W50GR/L-L
CGWSR/L2525-W50GR/L-L	5	21	25	25	162.5	55.5	25	31.9	WG*50, WGE50R/L	CGWSR/L2525	W50GR/L-L

• When using a right or left hand blade set, the right hand blade set is used with right hand shank and the left hand blade set is used with left hand shank.
 * Blade sold separately.

SPARE PARTS

Designation	Clamping screw	Blade screw	Wrench
CGWSR/L***-W**GR/L-L	CHHM5-18	CSHB-6	P-4

Reference pages

Inserts → C098 - C099, Standard cutting conditions → C099

MY-T SERIES

CGWSR/L

Shank of toolholders CGWSR/L-WG, -WG-L, -G, -CGD, -FL-G/TP & -#S/D

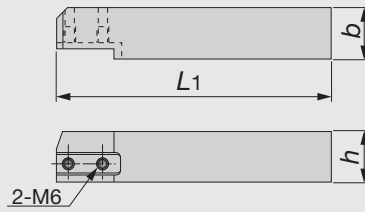

Right hand (R) shown.

Inch	<i>h</i>	<i>b</i>	<i>L1</i>
CGWSR/L12	0.75	0.75	5.40
CGWSR/L16	1.00	1.00	5.40

Metric	<i>h</i>	<i>b</i>	<i>L1</i>
CGWSR/L2020	20	20	137
CGWSR/L2525	25	25	137

Note: Right hand tool holders (R) use right hand cartridges (R)
Left hand tool holders (L) use left hand cartridges (L)

SPARE PARTS



Designation	Blade screw
CGWSR/L...	CSHB-6

MY-T SERIES

CGWSRL

Shank of toolholders. Vertical type with offset

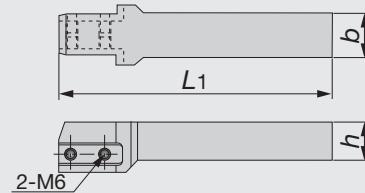

Inch	<i>h</i>	<i>b</i>	<i>L1</i>
CGWSRL12	0.75	0.75	5.40
CGWSRL16	1.00	1.00	5.40

Note: Right (R) or Left (L) hand cartridges can be used in this toolholder

SPARE PARTS



Designation	Blade screw
CGWSRL...	CSHB-6



Grooving Tool

MY-T SERIES



MY-T SERIES

CGWTR/L

Shank of perpendicular toolholders CGWTR/L-G, -CGD, -FL & -#S/D

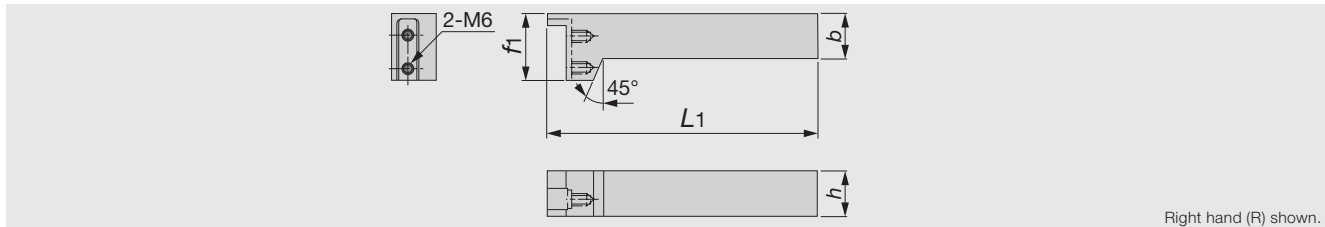

Inch	<i>h</i>	<i>b</i>	<i>L1</i>	<i>f1</i>
CGWTR/L12	0.75	0.75	6.00	1.50
CGWTR/L16	1.00	1.00	6.00	1.50

Metric	<i>h</i>	<i>b</i>	<i>L1</i>	<i>f1</i>
CGWTR/L2020	20	20	150	37
CGWTR/L2525	25	25	150	37

Note: Right hand tool holders (R) use left hand cartridges (L)
Left hand tool holders (L) use right hand cartridges (R)

SPARE PARTS



Designation	Blade screw
CGWTR/L...	C SHB-6

CCH-W

Blades for external grooving & parting off (2 corner)

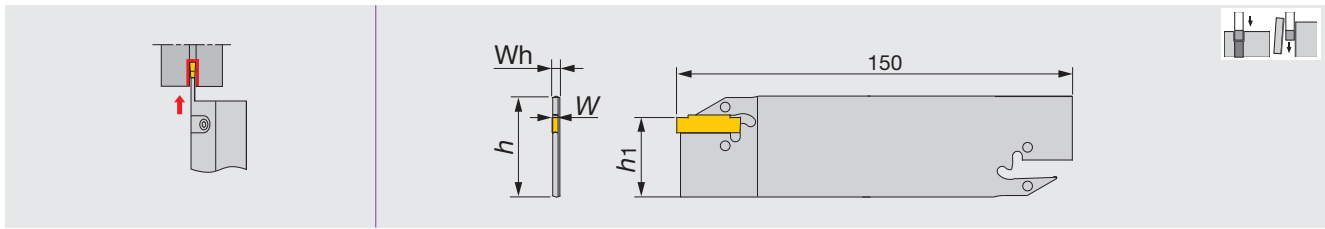

Inch	W	Applicable insert	Max. parting off dia.	Wh	h1	h
CCH32-W20	0.079	WGE20, WGE20R/L	1.3	0.063	0.968	(1.26)
CCH32-W30	0.118	WG*30, WGE30R/L	1.3	0.087	0.968	(1.26)
CCH32-W40	0.157	WG*40, WGE40R/L	1.65	0.126	0.965	(1.26)
CCH32-W50	0.197	WG*50, WGE50R/L	1.65	0.165	0.965	(1.26)

CCBS-32

Tool block for CCH blades

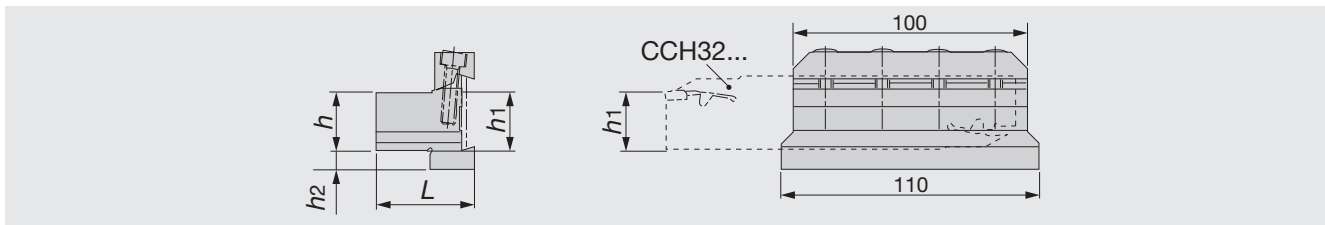

Inch	h	h1	h2	L	Blade*
CCBS12-32-U	0.75	0.75	0.55	1.49	CCH32...
CCBS16-32-U	1.00	1.00	0.30	1.66	CCH32...
CCBS20-32-U	1.25	1.25	0.21	1.66	CCH32...

* Blade sold separately.

SPARE PARTS

Designation	Clamp	Screw	Wrench
CCBS**32-U	CC-32	CM6X25	P-5



Grooving Tool

MY-T SERIES



External



Parting-off

Reference pages

Inserts → C098 - C099, Standard cutting conditions → C099



2 corner inserts

External grooving and parting off

WGE

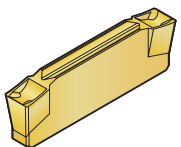

1st choice for external grooving and parting

Excellent chip control for grooving

W = 0.078" - 0.196"

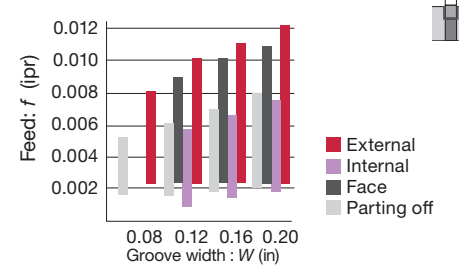

Page C099

Parting off

WGE R/L

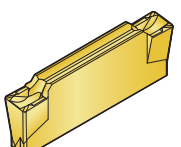

Handed insert

Minimize burr generation when workpiece is cut off

W = 0.078" - 0.196"

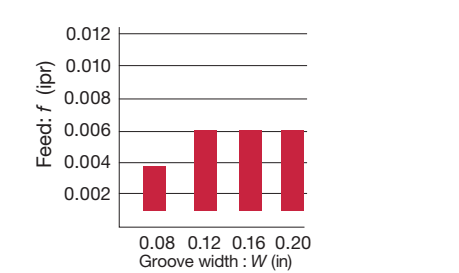

Page C099

External grooving and traversing

WGT

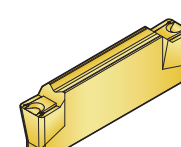

1st choice for traversing

Low cutting force and good chip control for traversing

W = 0.118" - 0.196"

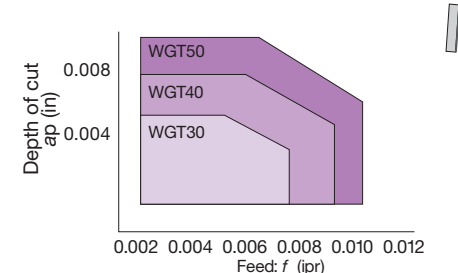

Page C099

Profiling

WGR

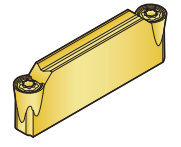

Low cutting force and good chip control for profiling

W = 0.118" - 0.196"

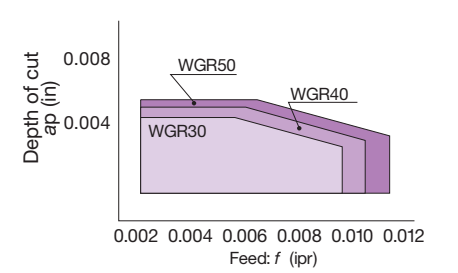

Page C099

WGE

For general parting off and grooving

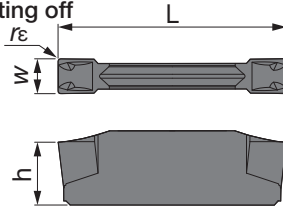

Designation	$W_{+0.1}^0$ (mm)	$W_{+0.004}^0$ (in)	$r\epsilon$ (in)	Coated			Cermet	L (in)	h (in)
				T9125	AH120	GH730	NS9530		
WGE20	2	0.078	0.008	●		●	●	0.787	0.185
WGE30	3	0.118	0.008	●	●	●	●	0.787	0.216
WGE40	4	0.157	0.008	●	●	●	●	0.984	0.224
WGE50	5	0.196	0.008	●	●	●	●	0.984	0.232

● : Line up

WGT

For traversing

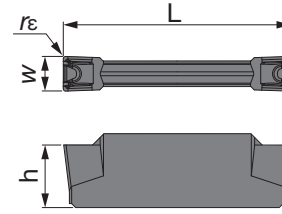

Designation	$W_{+0.1}^0$ (mm)	$W_{+0.004}^0$ (in)	$r\epsilon$ (in)	Coated			Cermet	L (in)	h (in)
				T9125	GH730	NS9530	NS9530		
WGT30	3	0.118	0.016	●	●	●	●	0.787	0.216
WGT40	4	0.157	0.016	●	●	●	●	0.984	0.224
WGT50	5	0.196	0.016	●	●	●	●	0.984	0.232

● : Line up

WGER/L

For parting off (with hand)

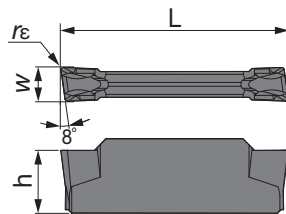

Right hand (R) shown.

Designation	$W_{+0.1}^0$ (mm)	$W_{+0.004}^0$ (in)	$r\epsilon$ (in)	Coated		L (in)	h (in)
				GH730			
				R	L		
WGE20R/L	2	0.078	0.008	●	●	0.787	0.185
WGE30R/L	3	0.118	0.008	●	●	0.787	0.216
WGE40R/L	4	0.157	0.008	●	●	0.984	0.224
WGE50R/L	5	0.196	0.008	●	●	0.984	0.232

● : Line up

WGR

For profiling

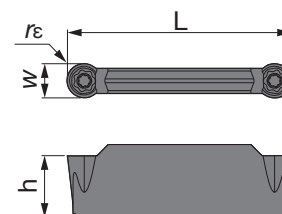

Designation	$W_{+0.1}^0$ (mm)	$W_{+0.004}^0$ (in)	$r\epsilon$ (in)	Coated			Cermet	L (in)	h (in)
				T9125	GH730	NS9530	NS9530		
WGR30	3	0.118	0.059	●	●	●	●	0.787	0.216
WGR40	4	0.157	0.078	●	●	●	●	0.984	0.224
WGR50	5	0.196	0.098	●	●	●	●	0.984	0.232

● : Line up

STANDARD CUTTING CONDITIONS

Workpiece material	Recommended grade	Cutting speed v_c (sfm)	Feed: f (ipr)			
			Groove width: W (in)			
			2 (0.078")	3 (0.118")	4 (0.157")	5 (0.196")
Low carbon steels Alloy steels (~ HB150)	T9125	260 ~ 650	0.002 ~ 0.008	0.002 ~ 0.009	0.003 ~ 0.011	0.003 ~ 0.012
	NS9530	260 ~ 550				
	GH730	160 ~ 590				
Medium carbon steels Alloy steels (HB150 ~ 250)	T9125	260 ~ 590	0.001 ~ 0.004	0.001 ~ 0.006	0.001 ~ 0.006	0.001 ~ 0.006
	NS9530	260 ~ 500				
	GH730	160 ~ 500				
High carbon steels Alloy steels (HB250 ~)	T9125	260 ~ 500	-	$a_p = 0.008 \sim 0.060$ $f = 0.002 \sim 0.006$	$a_p = 0.020 \sim 0.078$ $f = 0.002 \sim 0.009$	$a_p = 0.020 \sim 0.098$ $f = 0.002 \sim 0.010$
	NS9530	260 ~ 400				
	GH730	160 ~ 400				
Stainless steels	T9125	260 ~ 500	-	$a_p = 0.020 \sim 0.055$ $f = 0.002 \sim 0.010$	$a_p = 0.008 \sim 0.060$ $f = 0.002 \sim 0.010$	$a_p = 0.020 \sim 0.062$ $f = 0.002 \sim 0.012$
	GH730	160 ~ 400				
Gray and ductile cast irons	T9125	260 ~ 650	-	$a_p = 0.020 \sim 0.055$ $f = 0.002 \sim 0.010$	$a_p = 0.008 \sim 0.060$ $f = 0.002 \sim 0.010$	$a_p = 0.020 \sim 0.062$ $f = 0.002 \sim 0.012$
	GH730	160 ~ 590				

Note: For diameter compensation values in traversing, see page C118.



Grooving Tool

MY-T SERIES

CGWSR/L-G

External toolholders for grooving & parting & turning

MY-T SERIES

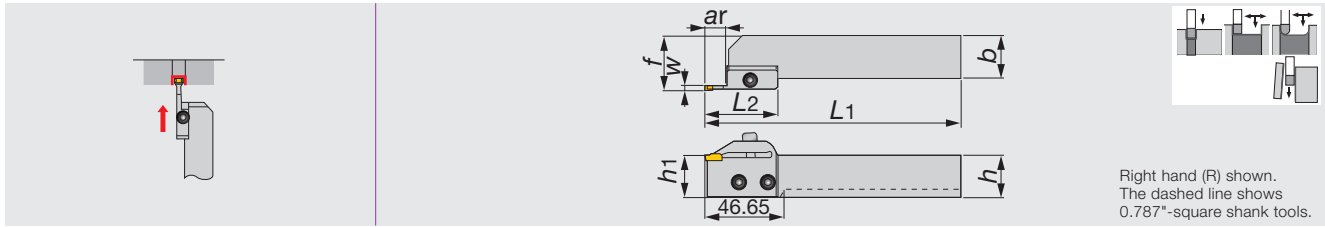

Inch	W	ar	h	b	L1	L2	h1	f	Insert	Shank	Blade*
CGWSR/L12-20GR/L	0.079	0.472	0.750	0.750	5.913	1.699	0.787	1.055	GE20, GE20-AL	CGWSR/L12	20GR/L
CGWSR/L16-20GR/L	0.079	0.472	1.000	1.000	5.913	1.699	0.984	1.252	GE20, GE20-AL	CGWSR/L16	20GR/L
CGWSR/L12-30GR/L	0.118	0.472	0.750	0.750	5.913	1.699	0.787	1.063	G*30,GE30R/L,GE30-AL	CGWSR/L12	30GR/L
CGWSR/L16-30GR/L	0.118	0.472	1.000	1.000	5.913	1.699	0.984	1.260	G*30,GE30R/L,GE30-AL	CGWSR/L16	30GR/L
CGWSR/L12-40GR/L	0.157	0.472	0.750	0.750	5.913	1.699	0.787	1.067	G*40,GE40R/L,GE40-AL	CGWSR/L12	40GR/L
CGWSR/L16-40GR/L	0.157	0.472	1.000	1.000	5.913	1.699	0.984	1.264	G*40,GE40R/L,GE40-AL	CGWSR/L16	40GR/L
CGWSR/L12-50GR/L	0.197	0.472	0.750	0.750	5.913	1.699	0.787	1.071	G*50,GE50R	CGWSR/L12	50GR

Metric	W	ar	h	b	L1	L2	h1	f	Insert	Shank	Blade*
CGWSR/L2020-20GR/L	2	12	20	20	150.2	43.15	20	26.8	GE20, GE20-AL	CGWSR/L2020	20GR/L
CGWSR/L2525-20GR/L	2	12	25	25	150.2	43.15	25	31.8	GE20, GE20-AL	CGWSR/L2525	20GR/L
CGWSR/L2020-30GR/L	3	12	20	20	150.2	43.15	20	27	G*30,GE30R/L,GE30-AL	CGWSR/L2020	30GR/L
CGWSR/L2525-30GR/L	3	12	25	25	150.2	43.15	25	32	G*30,GE30R/L,GE30-AL	CGWSR/L2525	30GR/L
CGWSR/L2020-40GR/L	4	12	20	20	150.2	43.15	20	27.1	G*40,GE40R/L,GE40-AL	CGWSR/L2020	40GR/L
CGWSR/L2525-40GR/L	4	12	25	25	150.2	43.15	25	32.1	G*40,GE40R/L,GE40-AL	CGWSR/L2525	40GR/L
CGWSR/L2020-50GR/L	5	12	20	20	150.2	43.15	20	27.2	G*50,GE50R	CGWSR/L2020	50GR

Note: For diameter compensation values in traversing, see page C118.

When using a right or left hand blade set, the right hand blade set is used with right hand shank and the left hand blade set is used with left hand shank.

* Blade sold separately.



External

SPARE PARTS

Designation	Clamping screw	Blade screw	Wrench
CGWSR/L****-**GR/L	CHHM5-18	CSHB-6	P-4



Parting-off

Others

Reference pages

Inserts → C112 - C115, Standard cutting conditions → C115

MY-T SERIES

CGWTR/L-G

External toolholders for grooving & parting & turning

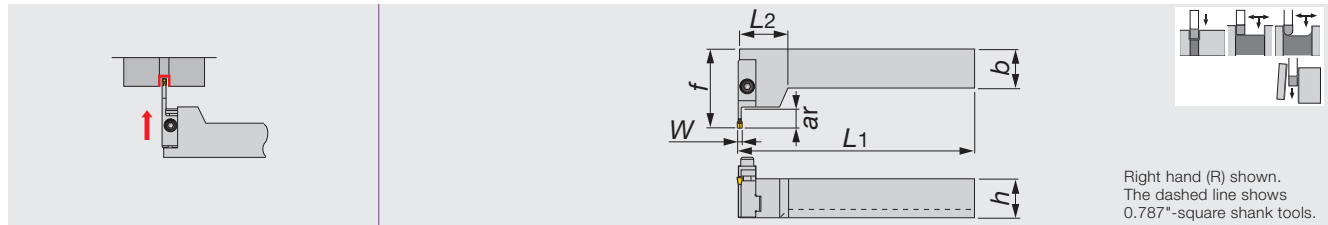

Right hand (R) shown.
The dashed line shows
0.787\"/>

Inch	W	ar	h	b	L1	L2	f	Insert	Shank	Blade*
CGWTR/L12-30GL/R	0.118	0.472	0.750	0.750	5.911	0.508	1.960	G*30,GE30R/L,GE30-AL	CGWTR/L12	30GL/R
CGWTR/L16-30GL/R	0.118	0.472	1.000	1.000	5.911	0.508	1.960	G*30,GE30R/L,GE30-AL	CGWTR/L16	30GL/R
CGWTR/L12-40GL/R	0.157	0.472	0.750	0.750	5.911	0.508	1.960	G*40,GE40R/L,GE40-AL	CGWTR/L12	40GL/R
CGWTR/L16-40GL/R	0.157	0.472	1.000	1.000	5.911	0.508	1.960	G*40,GE40R/L,GE40-AL	CGWTR/L16	40GL/R
CGWTR/L12-50GL/R	0.197	0.472	0.750	0.750	5.911	0.508	1.960	G*50,GE50R/L,GE50-AL	CGWTR/L12	50GL/R
CGWTR/L16-50GL/R	0.197	0.472	1.000	1.000	5.911	0.508	1.960	G*50,GE50R/L,GE50-AL	CGWTR/L16	50GL/R
Metric	W	ar	h	b	L1	L2	f	Insert	Shank	Blade*
CGWTR/L2020-30GL/R	3	12	20	20	150	12.9	49.9	G*30,GE30R/L,GE30-AL	CGWTR/L2020	30GL/R
CGWTR/L2525-30GL/R	3	12	25	25	150	12.9	49.9	G*30,GE30R/L,GE30-AL	CGWTR/L2525	30GL/R
CGWTR/L2020-40GL/R	4	12	20	20	150.1	12.9	49.9	G*40,GE40R/L,GE40-AL	CGWTR/L2020	40GL/R
CGWTR/L2525-40GL/R	4	12	25	25	150.1	12.9	49.9	G*40,GE40R/L,GE40-AL	CGWTR/L2525	40GL/R
CGWTR/L2020-50GL/R	5	12	20	20	150.2	12.9	49.9	G*50,GE50R/L,GE50-AL	CGWTR/L2020	50GL/R
CGWTR/L2525-50GL/R	5	12	25	25	150.2	12.9	49.9	G*50,GE50R/L,GE50-AL	CGWTR/L2525	50GL/R

Note: For diameter compensation values in traversing, see page C118.

When using a right or left hand blade set, the right hand blade set is used with left hand shank and the left hand blade set is used with right hand shank.

* Blade sold separately.

SPARE PARTS

Designation	Clamping screw	Blade screw	Wrench
CGWTR/L***-**GL/R	CHHM5-18	CSHB-6	P-4

MY-T SERIES

CGSSR/L

External toolholders for grooving & parting & turning

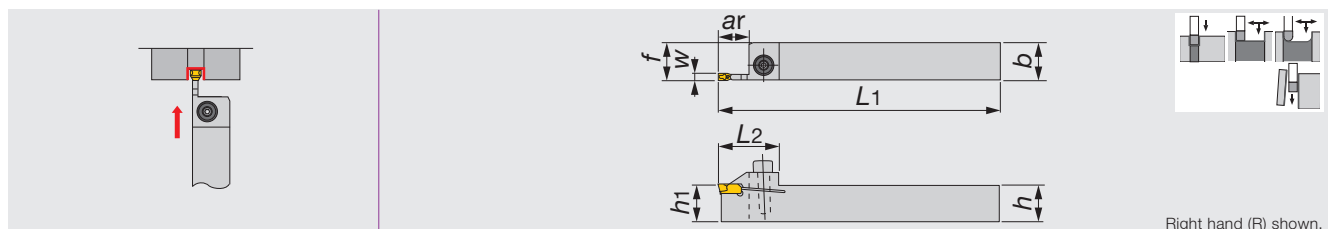

Right hand (R) shown.

Metric	W	ar	h	b	L1	L2	h1	f	Insert
CGSSR/L1616-20	2	16	16	16	125	27	16	16.2	GE20, GE20-AL
CGSSR/L2020-20	2	16	20	20	150	27	20	20.2	GE20, GE20-AL
CGSSR/L2525-20	2	16	25	25	150	27	25	25.2	GE20, GE20-AL
CGSSR/L1616-30	3	12	16	16	125	27	16	16.5	G*30,GE30R/L,GE30-AL
CGSSR/L2020-30	3	12	20	20	150	27	20	20.5	G*30,GE30R/L,GE30-AL
CGSSR/L2525-30	3	12	25	25	150	27	25	25.5	G*30,GE30R/L,GE30-AL
CGSSR/L2020-40	4	12	20	20	150	27	20	20.6	G*40,GE40R/L,GE40-AL
CGSSR/L2525-40	4	12	25	25	150	27	25	25.6	G*40,GE40R/L,GE40-AL
CGSSR/L2020-50	5	12	20	20	150	27	20	20.7	G*50,GE50R/L,GE50-AL
CGSSR/L2525-50	5	12	25	25	150	27	25	25.7	G*50,GE50R/L,GE50-AL

SPARE PARTS

Designation	Clamping screw	Wrench
CGSSR/L...	CHHM5-18	P-4

Reference pages

Inserts → C112 - C115, Standard cutting conditions → C115



Grooving Tool

MY-T SERIES



External



Parting-off

Others



Grooving Tool

MY-T SERIES

CGSSR/L-D

External toolholders for deep grooving & parting & turning

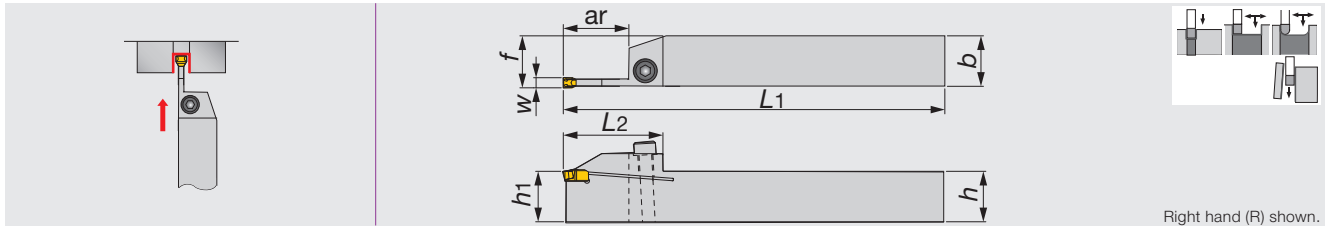

Metric	W	ar	h	b	L1	L2	h1	f	Insert
CGSSR/L1616-30D	3	22	16	16	125	36.2	16	16.5	G*30,GE30R/L,GE30-AL
CGSSR/L2020-30D	3	22	20	20	150	36.2	20	20.5	G*30,GE30R/L,GE30-AL
CGSSR/L2525-30D	3	22	25	25	150	36.2	25	25.5	G*30,GE30R/L,GE30-AL
CGSSR/L2020-40D	4	25	20	20	150	39.5	20	20.6	G*40,GE40R/L,GE40-AL
CGSSR/L2525-40D	4	25	25	25	150	39.5	25	25.6	G*40,GE40R/L,GE40-AL
CGSSR/L2020-50D	5	25	20	20	150	39.5	20	20.7	G*50,GE50R/L
CGSSR/L2525-50D	5	25	25	25	150	39.5	25	25.7	G*50,GE50R/L

SPARE PARTS

Designation	Clamping screw	Wrench
CGSSR/L***-**D	CHHM5-18	P-4

MY-T SERIES

JCGSSR/L

External grooving toolholders for swiss lathe



External

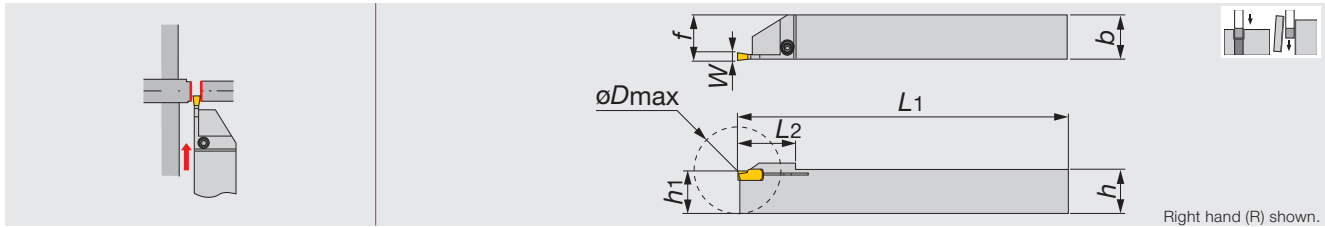

Metric	W	øDmax	h	b	L1	L2	h1	f	Insert
JCGSSR/L1010-20	2	20	10	10	125	15	10	10.2	GE20, GE20-AL
JCGSSR/L1212-20	2	25	12	12	125	19	12	12.2	GE20, GE20-AL
JCGSSR/L1616-20	2	32	16	16	125	22.5	16	16.2	GE20, GE20-AL

• øDmax: Max. parting off diameter.



Parting-off

Others

SPARE PARTS

Designation	Clamping screw	Wrench
JCGSSR/L...	CSTB-3	T-9F

Reference pages

Inserts → C112 - C115, Standard cutting conditions → C115

MY-T SERIES

CCH

Blades for external grooving & parting off (for 1 corner insert)

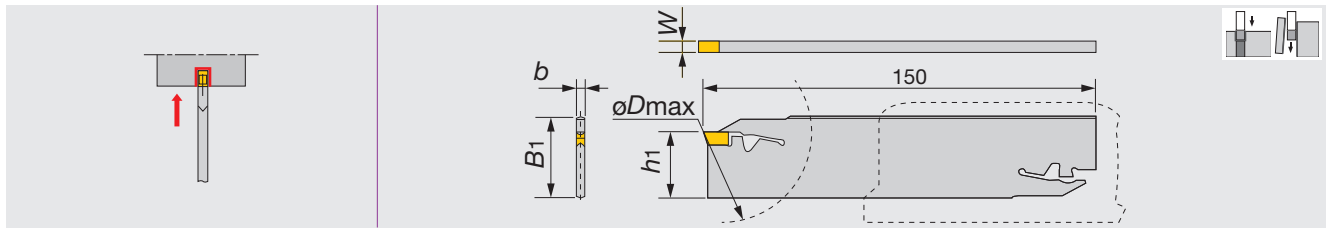

Inch	W	øDmax	b	h1	B1	Insert
CCH26-30	0.118	2.76	0.087	0.843	0.979	GE30,GE30R/L,GE30-AL
CCH26-40	0.157	2.76	0.126	0.837	0.968	GE40,GE40R/L,GE40-AL
CCH32-30U	0.118	3.94	0.087	0.968	1.230	GE30,GE30R/L,GE30-AL
CCH32-40U	0.157	3.94	0.126	0.963	1.220	GE40,GE40R/L,GE40-AL
CCH32-50U	0.197	4.72	0.165	0.958	1.210	GE50,GE50R/L,GE50-AL

• øDmax: Max. parting off diameter

SPARE PARTS

Designation	Wrench
CCH...	CTL-2

CCBS-32

Tool block for CCH blades

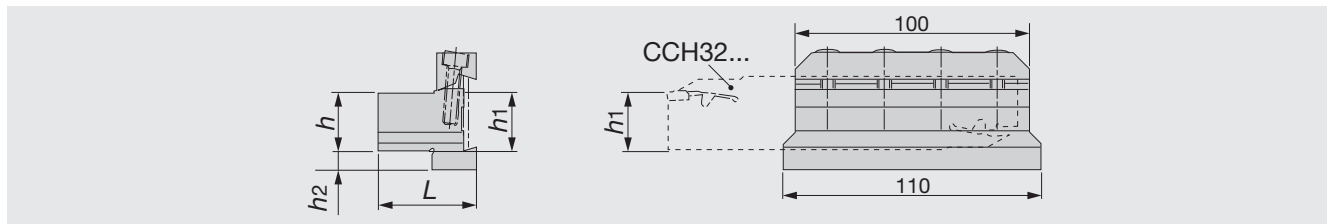

Inch	h	h1	h2	L	Blade
CCBS12-32-U	0.750	0.75	0.55	1.49	CCH32...
CCBS16-32-U	1.000	1.00	0.30	1.66	CCH32...
CCBS20-32-U	1.250	1.25	0.21	1.66	CCH32...

SPARE PARTS

Designation	Clamp	Screw	Wrench
CCBS**-32-U	CC-32	CM6X25	P-5

Reference pages

Inserts → **C112 - C115**, Standard cutting conditions → **C115**



Grooving Tool

MY-T SERIES



External



Parting-off

**CTBU**

Tool block for CGP and EGP blades

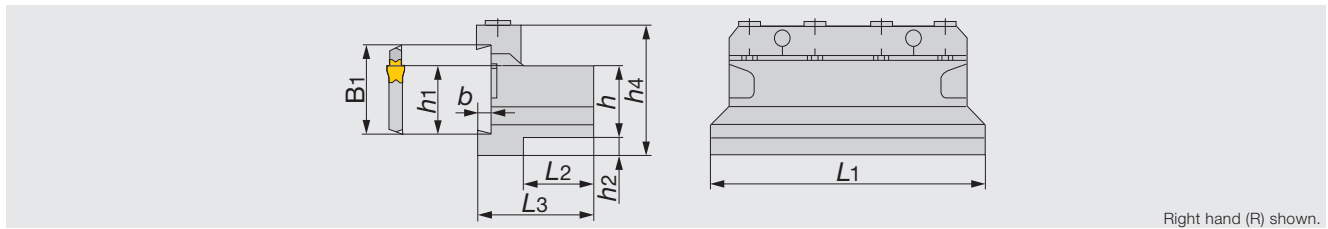

Inch	h_1	b	B_1	L_1	h	h_2	h_4	L_2	L_3	Blade*
CTBU12-26-U	0.843	0.157	1.024	3.386	0.750	0.354	1.693	0.827	1.496	CGP26..., CCH26...
CTBU16-26-U	0.843	0.157	1.024	4.331	1.000	0.197	1.772	0.906	1.654	CGP26..., CCH26...
CTBU12-32-U	0.976	0.209	1.260	3.937	0.750	0.512	1.969	0.748	1.496	CGP32..., CCH32...
CTBU16-32-U	0.976	0.209	1.260	4.331	1.000	0.315	1.969	0.906	1.654	CGP32..., CCH32...
CTBU20-32-U	0.976	0.209	1.260	4.331	1.250	0.197	2.126	1.142	1.890	CGP32..., CCH32...

Metric	h_1	b	B_1	L_1	h	h_2	h_4	L_2	L_3	Blade*
CTBU20-26	21.4	4	26	86	20	9	43	21	38	CGP26..., CCH26...
CTBU25-26	21.4	4	26	110	25	5	45	23	42	CGP26..., CCH26...
CTBU20-32	24.8	5.3	32	100	20	13	50	19	38	CGP32..., CCH32...
CTBU25-32	24.8	5.3	32	110	25	8	50	23	42	CGP32..., CCH32...
CTBU32-32	24.8	5.3	32	110	32	5	54	29	48	CGP32..., CCH32...

* Blade sold separately.

SPARE PARTS

Designation	Clamp	Clamping screw	Wrench
CTBU12-26-U, CTBU20-26	CT-86	CM6X30-S	P-5
CTBU12-32-U, CTBU25-26	CT-105	CM6X30-S	P-5
CTBU16-26-U, CTBU20-32	CT-100	CM6X30-S	P-5
CTBU16-32-U, CTBU25-32	CT-110	CM6X30-S	P-5
CTBU20-32-U, CTBU32-32	CT-110	CM6X30-S	P-5

MEMO

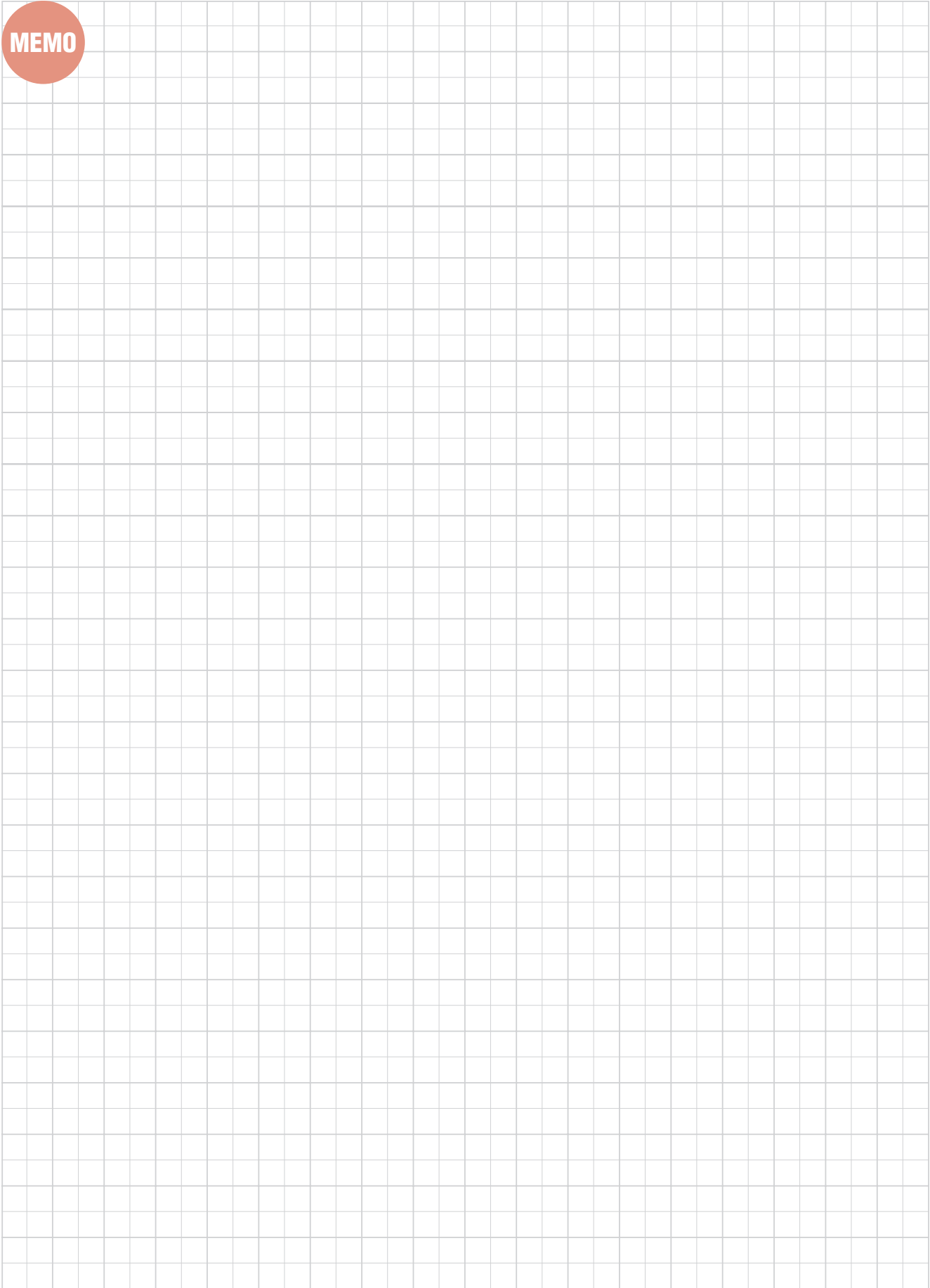

Grooving Tool

MY-T SERIES



MY-T SERIES

#S/D##R/L+CGWSR/L

Blades of "My-T" toolholders CGWSR/L-#S/D & CGWTR/L-#S/D for face grooving & turning

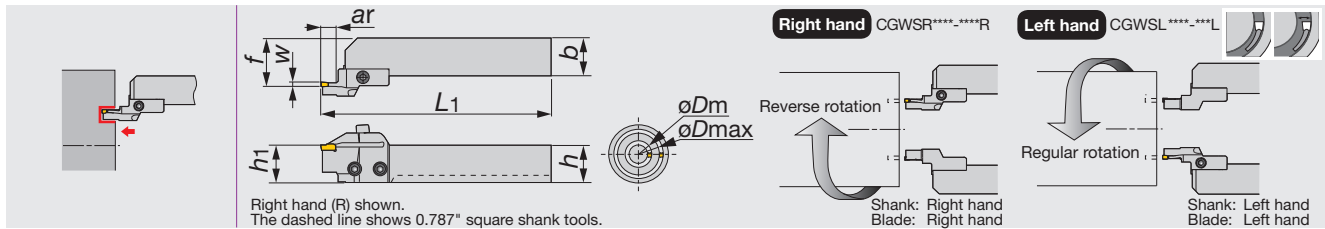

Inch	W	øDm	øDmax	ar	h	b	L1	h1	f	Insert	Shank
30S3040R/L	0.118	1.181	1.575	0.393	0.750/1.0	0.750/1.0	6.004	0.750/1.0	1.063/1.260	G*30, GE30-AL	CGWSR/L12, 16
30S4050R/L	0.118	1.575	1.696	0.393	0.750/1.0	0.750/1.0	6.004	0.750/1.0	1.063/1.260	G*30, GE30-AL	CGWSR/L12, 16
30S5065R/L	0.118	1.696	2.559	0.393	0.750/1.0	0.750/1.0	6.004	0.750/1.0	1.063/1.260	G*30, GE30-AL	CGWSR/L12, 16
30S6590R/L	0.118	2.559	3.543	0.393	0.750/1.0	0.750/1.0	6.004	0.750/1.0	1.063/1.260	G*30, GE30-AL	CGWSR/L12, 16
30S90150R/L	0.118	3.543	5.906	0.393	0.750/1.0	0.750/1.0	6.004	0.750/1.0	1.063/1.260	G*30, GE30-AL	CGWSR/L12, 16
30S150500R/L	0.118	5.906	19.685	0.393	0.750/1.0	0.750/1.0	6.004	0.750/1.0	1.063/1.260	G*30, GE30-AL	CGWSR/L12, 16
40S3545R/L	1.157	1.378	1.772	0.551	0.750/1.0	0.750/1.0	6.004	0.750/1.0	1.063/1.260	G*40, GE40-AL	CGWSR/L12, 16
40S4555R/L	1.157	1.772	2.165	0.551	0.750/1.0	0.750/1.0	6.004	0.750/1.0	1.063/1.260	G*40, GE40-AL	CGWSR/L12, 16
40S5580R/L	1.157	2.165	3.150	0.551	0.750/1.0	0.750/1.0	6.004	0.750/1.0	1.063/1.260	G*40, GE40-AL	CGWSR/L12, 16
40S80140R/L	1.157	3.150	5.512	0.551	0.750/1.0	0.750/1.0	6.004	0.750/1.0	1.063/1.260	G*40, GE40-AL	CGWSR/L12, 16
40S140500R/L	1.157	5.512	19.685	0.551	0.750/1.0	0.750/1.0	6.004	0.750/1.0	1.063/1.260	G*40, GE40-AL	CGWSR/L12, 16
40D3545R/L	1.157	1.378	1.772	0.866	0.750/1.0	0.750/1.0	6.319	0.750/1.0	1.063/1.260	G*40, GE40-AL	CGWSR/L12, 16
40D4555R/L	1.157	1.772	2.165	0.866	0.750/1.0	0.750/1.0	6.319	0.750/1.0	1.063/1.260	G*40, GE40-AL	CGWSR/L12, 16
40D5580R/L	1.157	2.165	3.150	0.866	0.750/1.0	0.750/1.0	6.319	0.750/1.0	1.063/1.260	G*40, GE40-AL	CGWSR/L12, 16
40D80140R/L	1.157	3.150	5.512	0.866	0.750/1.0	0.750/1.0	6.319	0.750/1.0	1.063/1.260	G*40, GE40-AL	CGWSR/L12, 16
40D140500R/L	1.157	5.512	19.685	0.866	0.750/1.0	0.750/1.0	6.319	0.750/1.0	1.063/1.260	G*40, GE40-AL	CGWSR/L12, 16
50S3545R/L	0.197	1.378	1.772	0.551	0.750/1.0	0.750/1.0	6.004	0.750/1.0	1.063/1.260	G*50	CGWSR/L12, 16
50S4555R/L	0.197	1.772	2.165	0.551	0.750/1.0	0.750/1.0	6.004	0.750/1.0	1.063/1.260	G*50	CGWSR/L12, 16
50S5575R/L	0.197	2.165	2.953	0.551	0.750/1.0	0.750/1.0	6.004	0.750/1.0	1.063/1.260	G*50	CGWSR/L12, 16
50S75130R/L	0.197	2.953	5.118	0.551	0.750/1.0	0.750/1.0	6.004	0.750/1.0	1.063/1.260	G*50	CGWSR/L12, 16
50S130500R/L	0.197	5.118	19.685	0.551	0.750/1.0	0.750/1.0	6.004	0.750/1.0	1.063/1.260	G*50	CGWSR/L12, 16
50D3545R/L	0.197	1.378	1.772	0.866	0.750/1.0	0.750/1.0	6.319	0.750/1.0	1.063/1.260	G*50	CGWSR/L12, 16
50D4555R/L	0.197	1.772	2.165	0.866	0.750/1.0	0.750/1.0	6.319	0.750/1.0	1.063/1.260	G*50	CGWSR/L12, 16
50D5575R/L	0.197	2.165	2.953	0.866	0.750/1.0	0.750/1.0	6.319	0.750/1.0	1.063/1.260	G*50	CGWSR/L12, 16
50D75130R/L	0.197	2.953	5.118	0.866	0.750/1.0	0.750/1.0	6.319	0.750/1.0	1.063/1.260	G*50	CGWSR/L12, 16
50D130500R/L	0.197	5.118	19.685	0.866	0.750/1.0	0.750/1.0	6.319	0.750/1.0	1.063/1.260	G*50	CGWSR/L12, 16

- There are 2 shank type of CGWSR/L and CGWTR/L.
- CGWSR/L Shank : The right hand blade set(...R) is used with right hand shank(CGWSR...) and the left hand blade set(...L) is used with left hand shank(CGWSL...).
- CGWTR/L Shank : The left hand blade set(...L) is used with right hand shank(CGWTR...) and the right hand blade set(...R) is used with left hand shank(CGWTL...).



SPARE PARTS

Designation	Clamping screw	Blade screw	Wrench
30S..., 40S...	CHHM5-18	CSHB-6	P-4
40D...	CM5X0.8X16	CSHB-6	P-4
50S...	CHHM5-18	CSHB-6	P-4
50D...	CM5X0.8X16	CSHB-6	P-4

Reference pages

Inserts → C112 - C115, Standard cutting conditions → C115



Metric	W	ϕD_m	ϕD_{max}	a _r	h	b	L ₁	h ₁	f	Insert	Shank
30S3040R/L	3	30	40	10	20/25	20/25	152.5	20/25	27/32	G*30, GE30-AL	CGWSR/L2020, 2525
30S4050R/L	3	40	50	10	20/25	20/25	152.5	20/25	27/32	G*30, GE30-AL	CGWSR/L2020, 2525
30S5065R/L	3	50	65	10	20/25	20/25	152.5	20/25	27/32	G*30, GE30-AL	CGWSR/L2020, 2525
30S6590R/L	3	65	90	10	20/25	20/25	152.5	20/25	27/32	G*30, GE30-AL	CGWSR/L2020, 2525
30S90150R/L	3	90	150	10	20/25	20/25	152.5	20/25	27/32	G*30, GE30-AL	CGWSR/L2020, 2525
30S150500R/L	3	150	500	10	20/25	20/25	152.5	20/25	27/32	G*30, GE30-AL	CGWSR/L2020, 2525
40S3545R/L	4	35	45	14	20/25	20/25	152.5	20/25	27/32	G*40, GE40-AL	CGWSR/L2020, 2525
40S4555R/L	4	45	55	14	20/25	20/25	152.5	20/25	27/32	G*40, GE40-AL	CGWSR/L2020, 2525
40S5580R/L	4	55	80	14	20/25	20/25	152.5	20/25	27/32	G*40, GE40-AL	CGWSR/L2020, 2525
40S80140R/L	4	80	140	14	20/25	20/25	152.5	20/25	27/32	G*40, GE40-AL	CGWSR/L2020, 2525
40S140500R/L	4	140	500	14	20/25	20/25	152.5	20/25	27/32	G*40, GE40-AL	CGWSR/L2020, 2525
40D3545R/L	4	35	45	22	20/25	20/25	160.5	20/25	27/32	G*40, GE40-AL	CGWSR/L2020, 2525
40D4555R/L	4	45	55	22	20/25	20/25	160.5	20/25	27/32	G*40, GE40-AL	CGWSR/L2020, 2525
40D5580R/L	4	55	80	22	20/25	20/25	160.5	20/25	27/32	G*40, GE40-AL	CGWSR/L2020, 2525
40D80140R/L	4	80	140	22	20/25	20/25	160.5	20/25	27/32	G*40, GE40-AL	CGWSR/L2020, 2525
40D140500R/L	4	140	500	22	20/25	20/25	160.5	20/25	27/32	G*40, GE40-AL	CGWSR/L2020, 2525
50S3545R/L	5	35	45	14	20/25	20/25	152.5	20/25	27/32	G*50	CGWSR/L2020, 2525
50S4555R/L	5	45	55	14	20/25	20/25	152.5	20/25	27/32	G*50	CGWSR/L2020, 2525
50S5575R/L	5	55	75	14	20/25	20/25	152.5	20/25	27/32	G*50	CGWSR/L2020, 2525
50S75130R/L	5	75	130	14	20/25	20/25	152.5	20/25	27/32	G*50	CGWSR/L2020, 2525
50S130500R/L	5	130	500	14	20/25	20/25	152.5	20/25	27/32	G*50	CGWSR/L2020, 2525
50D3545R/L	5	35	45	22	20/25	20/25	160.5	20/25	27/32	G*50	CGWSR/L2020, 2525
50D4555R/L	5	45	55	22	20/25	20/25	160.5	20/25	27/32	G*50	CGWSR/L2020, 2525
50D5575R/L	5	55	75	22	20/25	20/25	160.5	20/25	27/32	G*50	CGWSR/L2020, 2525
50D75130R/L	5	75	130	22	20/25	20/25	160.5	20/25	27/32	G*50	CGWSR/L2020, 2525
50D130500R/L	5	130	500	22	20/25	20/25	160.5	20/25	27/32	G*50	CGWSR/L2020, 2525

• There are 2 shank type of CGWSR/L and CGWTR/L.

• CGWSR/L Shank : The right hand blade set(...R) is used with right hand shank(CGWSR...) and the left hand blade set(...L) is used with left hand shank(CGWSL...).

• CGWTR/L Shank : The left hand blade set(...L) is used with right hand shank(CGWTR...) and the right hand blade set(...R) is used with left hand shank(CGWTL...).

SPARE PARTS



Designation	Clamping screw	Blade screw	Wrench
30S..., 40S...	CHHM5-18	CSHB-6	P-4
40D...	CM5X0.8X16	CSHB-6	P-4
50S...	CHHM5-18	CSHB-6	P-4
50D...	CM5X0.8X16	CSHB-6	P-4



Reference pages

Inserts → C112 - C115, Standard cutting conditions → C115



MY-T SERIES

#S/D##R/L+CGWTR/L

Blades of "My-T" toolholders CGWSR/L-#S/D & CGWTR/L-#S/D for face grooving & turning

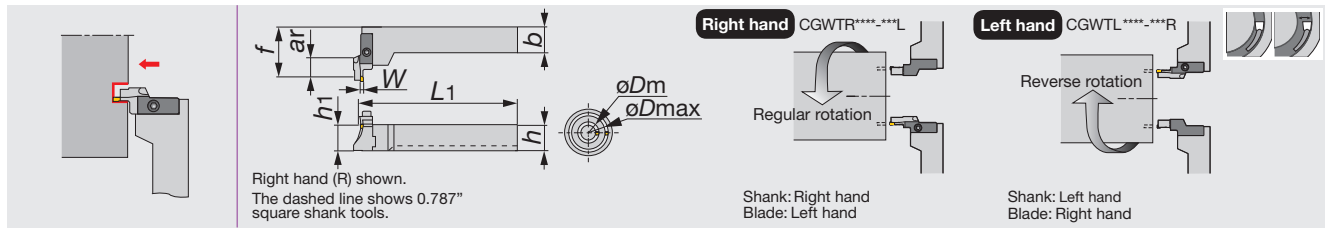

Inch	W	øDm	øDmax	ar	h	b	L1	h1	f	Insert	Shank
30S3040R/L	0.118	1.181	1.575	0.393	0.750/1.0	0.750/1.0	5.906	0.750/1.0	2.057	G*30, GE30-AL	CGWSR/L12, 16
30S4050R/L	0.118	1.575	1.696	0.393	0.750/1.0	0.750/1.0	5.906	0.750/1.0	2.057	G*30, GE30-AL	CGWSR/L12, 16
30S5065R/L	0.118	1.696	2.559	0.393	0.750/1.0	0.750/1.0	5.906	0.750/1.0	2.057	G*30, GE30-AL	CGWSR/L12, 16
30S6590R/L	0.118	2.559	3.543	0.393	0.750/1.0	0.750/1.0	5.906	0.750/1.0	2.057	G*30, GE30-AL	CGWSR/L12, 16
30S90150R/L	0.118	3.543	5.906	0.393	0.750/1.0	0.750/1.0	5.906	0.750/1.0	2.057	G*30, GE30-AL	CGWSR/L12, 16
30S150500R/L	0.118	5.906	19.685	0.393	0.750/1.0	0.750/1.0	5.906	0.750/1.0	2.057	G*30, GE30-AL	CGWSR/L12, 16
40S3545R/L	0.157	1.378	1.772	0.551	0.750/1.0	0.750/1.0	5.906	0.750/1.0	2.057	G*40, GE40-AL	CGWSR/L12, 16
40S4555R/L	0.157	1.772	2.165	0.551	0.750/1.0	0.750/1.0	5.906	0.750/1.0	2.057	G*40, GE40-AL	CGWSR/L12, 16
40S5580R/L	0.157	2.165	3.150	0.551	0.750/1.0	0.750/1.0	5.906	0.750/1.0	2.057	G*40, GE40-AL	CGWSR/L12, 16
40S80140R/L	0.157	3.150	5.512	0.551	0.750/1.0	0.750/1.0	5.906	0.750/1.0	2.057	G*40, GE40-AL	CGWSR/L12, 16
40S140500R/L	0.157	5.512	19.685	0.551	0.750/1.0	0.750/1.0	5.906	0.750/1.0	2.057	G*40, GE40-AL	CGWSR/L12, 16
40D3545R/L	0.157	1.378	1.772	0.866	0.750/1.0	0.750/1.0	5.906	0.750/1.0	2.372	G*40, GE40-AL	CGWSR/L12, 16
40D4555R/L	0.157	1.772	2.165	0.866	0.750/1.0	0.750/1.0	5.906	0.750/1.0	2.372	G*40, GE40-AL	CGWSR/L12, 16
40D5580R/L	0.157	2.165	3.150	0.866	0.750/1.0	0.750/1.0	5.906	0.750/1.0	2.372	G*40, GE40-AL	CGWSR/L12, 16
40D80140R/L	0.157	3.150	5.512	0.866	0.750/1.0	0.750/1.0	5.906	0.750/1.0	2.372	G*40, GE40-AL	CGWSR/L12, 16
40D140500R/L	0.157	5.512	19.685	0.866	0.750/1.0	0.750/1.0	5.906	0.750/1.0	2.372	G*40, GE40-AL	CGWSR/L12, 16
50S3545R/L	0.197	1.378	1.772	0.551	0.750/1.0	0.750/1.0	5.906	0.750/1.0	2.057	G*50	CGWSR/L12, 16
50S4555R/L	0.197	1.772	2.165	0.551	0.750/1.0	0.750/1.0	5.906	0.750/1.0	2.057	G*50	CGWSR/L12, 16
50S5575R/L	0.197	2.165	2.953	0.551	0.750/1.0	0.750/1.0	5.906	0.750/1.0	2.057	G*50	CGWSR/L12, 16
50S75130R/L	0.197	2.953	5.118	0.551	0.750/1.0	0.750/1.0	5.906	0.750/1.0	2.057	G*50	CGWSR/L12, 16
50S130500R/L	0.197	5.118	19.685	0.551	0.750/1.0	0.750/1.0	5.906	0.750/1.0	2.057	G*50	CGWSR/L12, 16
50D3545R/L	0.197	1.378	1.772	0.866	0.750/1.0	0.750/1.0	5.906	0.750/1.0	2.372	G*50	CGWSR/L12, 16
50D4555R/L	0.197	1.772	2.165	0.866	0.750/1.0	0.750/1.0	5.906	0.750/1.0	2.372	G*50	CGWSR/L12, 16
50D5575R/L	0.197	2.165	2.953	0.866	0.750/1.0	0.750/1.0	5.906	0.750/1.0	2.372	G*50	CGWSR/L12, 16
50D75130R/L	0.197	2.953	5.118	0.866	0.750/1.0	0.750/1.0	5.906	0.750/1.0	2.372	G*50	CGWSR/L12, 16
50D130500R/L	0.197	5.118	19.685	0.866	0.750/1.0	0.750/1.0	5.906	0.750/1.0	2.372	G*50	CGWSR/L12, 16

- There are 2 shank type of CGWSR/L and CGWTR/L.
- CGWSR/L Shank : The right hand blade set(...R) is used with right hand shank(CGWSR...) and the left hand blade set(...L) is used with left hand shank(CGWSL...).
- CGWTR/L Shank : The left hand blade set(...L) is used with right hand shank(CGWTR...) and the right hand blade set(...R) is used with left hand shank(CGWTL...).



SPARE PARTS

Designation	Clamping screw	Blade screw	Wrench
30S..., 40S...	CHHM5-18	CSHB-6	P-4
40D...	CM5X0.8X16	CSHB-6	P-4
50S...	CHHM5-18	CSHB-6	P-4
50D...	CM5X0.8X16	CSHB-6	P-4

Reference pages

Inserts → C112 - C115, Standard cutting conditions → C115



Metric	W	ϕD_m	ϕD_{max}	a _r	h	b	L1	h1	f	Insert	Shank
30S3040R/L	3	30	40	10	20/25	20/25	150	20/25	52.25	G*30, GE30-AL	CGWSR/L2020, 2525
30S4050R/L	3	40	50	10	20/25	20/25	150	20/25	52.25	G*30, GE30-AL	CGWSR/L2020, 2525
30S5065R/L	3	50	65	10	20/25	20/25	150	20/25	52.25	G*30, GE30-AL	CGWSR/L2020, 2525
30S6590R/L	3	65	90	10	20/25	20/25	150	20/25	52.25	G*30, GE30-AL	CGWSR/L2020, 2525
30S90150R/L	3	90	150	10	20/25	20/25	150	20/25	52.25	G*30, GE30-AL	CGWSR/L2020, 2525
30S150500R/L	3	150	500	10	20/25	20/25	150	20/25	52.25	G*30, GE30-AL	CGWSR/L2020, 2525
40S3545R/L	4	35	45	14	20/25	20/25	150	20/25	52.25	G*40, GE40-AL	CGWSR/L2020, 2525
40S4555R/L	4	45	55	14	20/25	20/25	150	20/25	52.25	G*40, GE40-AL	CGWSR/L2020, 2525
40S5580R/L	4	55	80	14	20/25	20/25	150	20/25	52.25	G*40, GE40-AL	CGWSR/L2020, 2525
40S80140R/L	4	80	140	14	20/25	20/25	150	20/25	52.25	G*40, GE40-AL	CGWSR/L2020, 2525
40S140500R/L	4	140	500	14	20/25	20/25	150	20/25	52.25	G*40, GE40-AL	CGWSR/L2020, 2525
40D3545R/L	4	35	45	22	20/25	20/25	150	20/25	60.25	G*40, GE40-AL	CGWSR/L2020, 2525
40D4555R/L	4	45	55	22	20/25	20/25	150	20/25	60.25	G*40, GE40-AL	CGWSR/L2020, 2525
40D5580R/L	4	55	80	22	20/25	20/25	150	20/25	60.25	G*40, GE40-AL	CGWSR/L2020, 2525
40D80140R/L	4	80	140	22	20/25	20/25	150	20/25	60.25	G*40, GE40-AL	CGWSR/L2020, 2525
40D140500R/L	4	140	500	22	20/25	20/25	150	20/25	60.25	G*40, GE40-AL	CGWSR/L2020, 2525
50S3545R/L	5	35	45	14	20/25	20/25	150	20/25	52.25	G*50	CGWSR/L2020, 2525
50S4555R/L	5	45	55	14	20/25	20/25	150	20/25	52.25	G*50	CGWSR/L2020, 2525
50S5575R/L	5	55	75	14	20/25	20/25	150	20/25	52.25	G*50	CGWSR/L2020, 2525
50S75130R/L	5	75	130	14	20/25	20/25	150	20/25	52.25	G*50	CGWSR/L2020, 2525
50S130500R/L	5	130	500	14	20/25	20/25	150	20/25	52.25	G*50	CGWSR/L2020, 2525
50D3545R/L	5	35	45	22	20/25	20/25	150	20/25	60.25	G*50	CGWSR/L2020, 2525
50D4555R/L	5	45	55	22	20/25	20/25	150	20/25	60.25	G*50	CGWSR/L2020, 2525
50D5575R/L	5	55	75	22	20/25	20/25	150	20/25	60.25	G*50	CGWSR/L2020, 2525
50D75130R/L	5	75	130	22	20/25	20/25	150	20/25	60.25	G*50	CGWSR/L2020, 2525
50D130500R/L	5	130	500	22	20/25	20/25	150	20/25	60.25	G*50	CGWSR/L2020, 2525

- There are 2 shank type of CGWSR/L and CGWTR/L.
- CGWSR/L Shank : The right hand blade set(...R) is used with right hand shank(CGWSR...) and the left hand blade set(...L) is used with left hand shank(CGWSL...).
- CGWTR/L Shank : The left hand blade set(...L) is used with right hand shank(CGWTR...) and the right hand blade set(...R) is used with left hand shank(CGWTL...).

SPARE PARTS



Designation	Clamping screw	Blade screw	Wrench
30S..., 40S...	CHHM5-18	CSHB-6	P-4
40D...	CM5X0.8X16	CSHB-6	P-4
50S...	CHHM5-18	CSHB-6	P-4
50D...	CM5X0.8X16	CSHB-6	P-4



Reference pages

Inserts → C112 - C115, Standard cutting conditions → C115



MY-T SERIES

CGWSR/L

Shank of toolholders CGWSR/L-WG, -WG-L, -G, -CGD, -FL-G/TP & -#S/D

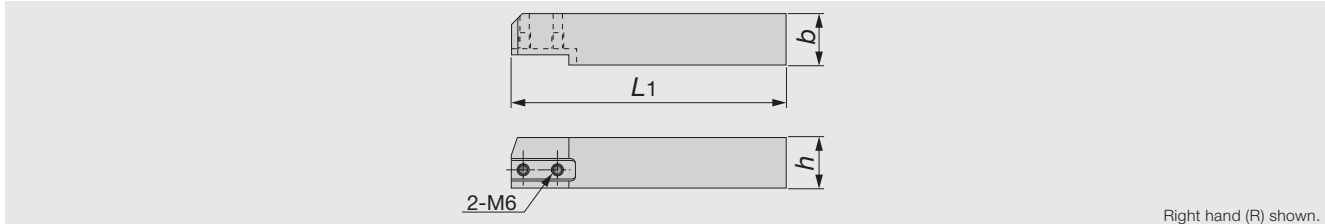

Inch	<i>h</i>	<i>b</i>	<i>L1</i>
CGWSR/L12	0.75	0.75	6.00
CGWSR/L16	1.00	1.00	6.00

Metric	<i>h</i>	<i>b</i>	<i>L1</i>
CGWSR/L2020	20	20	137
CGWSR/L2525	25	25	137

Note: Right hand tool holders (R) use right hand cartridges (R)
Left hand tool holders (L) use left hand cartridges (L)

SPARE PARTS



Designation	Blade screw
CGWSR/L...	CSHB-6

MY-T SERIES

CGWSRL

Shank of toolholders. Vertical type with offset

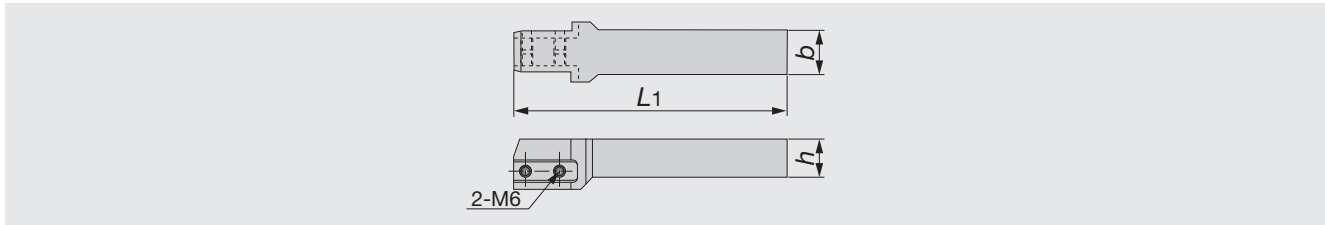

Inch	<i>h</i>	<i>b</i>	<i>L1</i>
CGWSRL12	0.75	0.75	6.00
CGWSRL16	1.00	1.00	6.00

Note: Right (R) or Left (L) hand cartridges can be used in this toolholder

SPARE PARTS



Designation	Blade screw
CGWSRL...	CSHB-6

MY-T SERIES

CGWTR/L

Shank of perpendicular toolholders CGWTR/L-G, -CGD, -FL & -#S/D

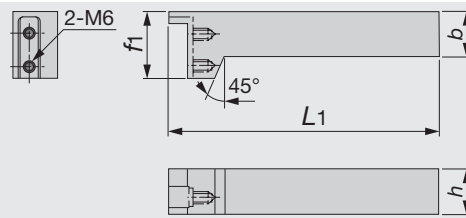

Right hand (R) shown.

Inch	<i>h</i>	<i>b</i>	<i>L1</i>	<i>f1</i>
CGWTR/L12	0.75	0.75	6.00	1.50
CGWTR/L16	1.00	1.00	6.00	1.50

Metric	<i>h</i>	<i>b</i>	<i>L1</i>	<i>f1</i>
CGWTR/L2020	20	20	150	37
CGWTR/L2525	25	25	150	37

Note: Right hand tool holders (R) use left hand cartridges (L)
Left hand tool holders (L) use right hand cartridges (R)

SPARE PARTS



Designation	Blade screw
CGWTR/L...	CSHB-6

MY-T SERIES

CGTR/L

Toolholders for internal grooving

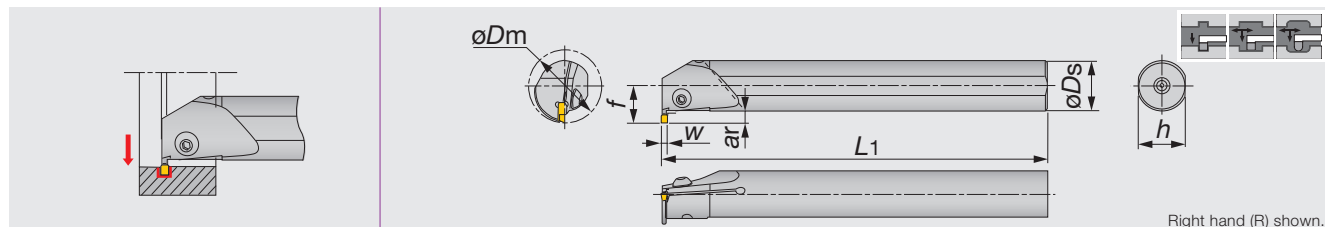

Right hand (R) shown.

Inch	<i>W</i>	$\varnothing D_m$	<i>ar</i>	$\varnothing D_s$	<i>f</i>	<i>L1</i>	<i>h</i>	Insert
A12Q-CGTR30U	0.118	1.0	0.138	0.75	0.571	7.09	0.709	G*30, GE30-AL
A16R-CGTR/L30U	0.118	1.26	0.197	1.00	0.728	7.87	0.961	G*30, GE30-AL
A16R-CGTR/L40U	0.157	1.26	0.197	1.00	0.728	7.87	0.961	G*40, GE40-AL
A20S-CGTR50U	0.197	1.575	0.236	1.25	0.906	9.84	1.21	G*50

SPARE PARTS



Designation	Clamping screw	Wrench
A***-CGTR/L...	BHM5-14	P-3

Reference pages

Inserts → C112 - C115, Standard cutting conditions → C115



Grooving Tool

MY-T SERIES



Internal

Others



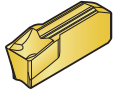
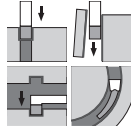

1 corner inserts

External grooving and parting off

<p>GE</p>  <p>Page C114</p>	<p>1st choice for external grooving and parting</p> <p>Excellent chip control for grooving</p> <p>W = 0.078" - 0.196"</p>	<table border="1"> <caption>Feed: f (ipr) vs Groove width: W (in) for GE</caption> <thead> <tr> <th>Groove width: W (in)</th> <th>External (ipr)</th> <th>Internal (ipr)</th> <th>Face (ipr)</th> <th>Parting off (ipr)</th> </tr> </thead> <tbody> <tr> <td>0.078</td> <td>0.008</td> <td>0.006</td> <td>0.009</td> <td>0.005</td> </tr> <tr> <td>0.118</td> <td>0.010</td> <td>0.007</td> <td>0.009</td> <td>0.006</td> </tr> <tr> <td>0.157</td> <td>0.011</td> <td>0.008</td> <td>0.010</td> <td>0.007</td> </tr> <tr> <td>0.196</td> <td>0.012</td> <td>0.009</td> <td>0.011</td> <td>0.008</td> </tr> </tbody> </table> 	Groove width: W (in)	External (ipr)	Internal (ipr)	Face (ipr)	Parting off (ipr)	0.078	0.008	0.006	0.009	0.005	0.118	0.010	0.007	0.009	0.006	0.157	0.011	0.008	0.010	0.007	0.196	0.012	0.009	0.011	0.008
Groove width: W (in)	External (ipr)	Internal (ipr)	Face (ipr)	Parting off (ipr)																							
0.078	0.008	0.006	0.009	0.005																							
0.118	0.010	0.007	0.009	0.006																							
0.157	0.011	0.008	0.010	0.007																							
0.196	0.012	0.009	0.011	0.008																							

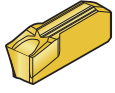
Parting off

<p>GE R/L</p>  <p>Page C114</p>	<p>Handed insert</p> <p>Minimize burr generation when workpiece is cut off</p> <p>W = 0.118" - 0.196"</p>	<table border="1"> <caption>Feed: f (ipr) vs Groove width: W (in) for GE R/L</caption> <thead> <tr> <th>Groove width: W (in)</th> <th>External (ipr)</th> </tr> </thead> <tbody> <tr> <td>0.118</td> <td>0.006</td> </tr> <tr> <td>0.157</td> <td>0.006</td> </tr> <tr> <td>0.196</td> <td>0.006</td> </tr> </tbody> </table> 	Groove width: W (in)	External (ipr)	0.118	0.006	0.157	0.006	0.196	0.006
Groove width: W (in)	External (ipr)									
0.118	0.006									
0.157	0.006									
0.196	0.006									

Grooving and traversing

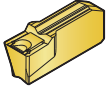
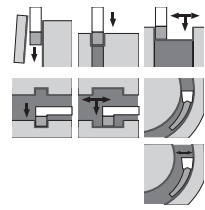
<p>GT</p>  <p>Page C114</p>	<p>1st choice for traversing</p> <p>Low cutting force and good chip control for traversing</p> <p>W = 0.118" - 0.196"</p>	
---	---	---

Profiling

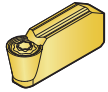
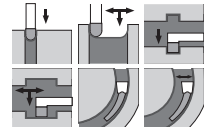
<p>GR</p>  <p>Page C114</p>	<p>Full radius type</p> <p>Low cutting force and good chip control for profiling</p> <p>W = 0.118" - 0.196"</p>	
---	---	---



1 corner inserts

Face grooving

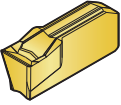
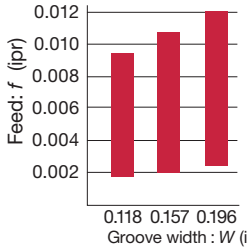
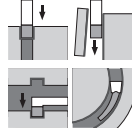
<p>GF</p>  <p>Page C114</p>	<p>1st choice for face grooving</p> <p>Low cutting force and good chip control for face grooving W = 0.118" - 0.196"</p>		
---	--	--	---

Internal grooving

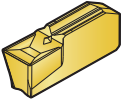
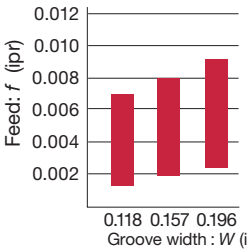
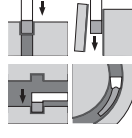
<p>GN</p>  <p>Page C114</p>	<p>1st choice for internal grooving</p> <p>Low cutting force and good chip control for internal grooving W = 0.118" - 0.196"</p>		
---	--	--	---

For non-ferrous materials

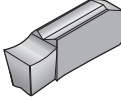
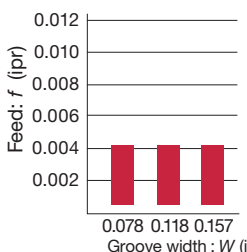
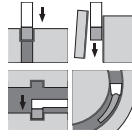
<p>GE-AL</p>  <p>Page C114</p>	<p>Reduce cutting force and welding due to sharp chipbreaker</p> <p>W = 0.078" - 0.157"</p>		
--	---	--	---



INSERT

GE

For general grooving

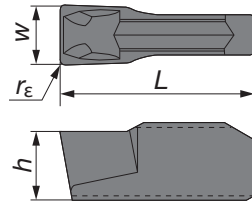

Designation	$W_0^{+0.1}$ (mm)	$W_0^{+0.004}$ (in)	$r\epsilon$ (in)	Coated			Cermet	L (in)	h (in)
				T9125	GH730	NS9530			
GE20	2	0.078	0.008		●	●		0.393	0.137
GE30	3	0.118	0.008	●	●	●		0.393	0.137
GE40	4	0.157	0.008	●	●	●		0.393	0.157
GE50	5	0.196	0.008	●	●	●		0.472	0.177

GN

For internal grooving

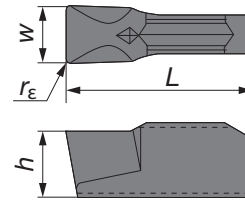

Designation	$W_0^{+0.1}$ (mm)	$W_0^{+0.004}$ (in)	$r\epsilon$ (in)	Coated			L (in)	h (in)
				GH730				
GN30	3	0.118	0.008	●			0.393	0.137
GN40	4	0.157	0.008	●			0.393	0.157
GN50	5	0.196	0.008	●			0.472	0.177

GT

For traversing

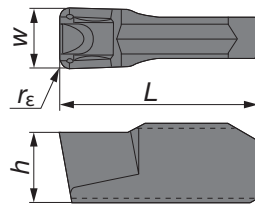

Designation	$W_0^{+0.1}$ (mm)	$W_0^{+0.004}$ (in)	$r\epsilon$ (in)	Coated			Cermet	L (in)	h (in)
				T9125	GH730	NS9530			
GT30	3	0.118	0.016		●	●		0.393	0.137
GT40	4	0.157	0.016		●	●		0.393	0.157
GT50	5	0.196	0.016	●	●	●		0.472	0.177

GR

For profiling

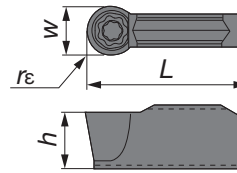

Designation	$W_0^{+0.1}$ (mm)	$W_0^{+0.004}$ (in)	$r\epsilon$ (in)	Coated			Cermet	L (in)	h (in)
				T9125	GH730	NS9530			
GR30	3	0.118	0.059		●	●		0.393	0.137
GR40	4	0.157	0.078	●	●	●		0.393	0.157
GR50	5	0.196	0.098	●	●	●		0.472	0.177

GE-AL

For aluminum and non-ferrous metals

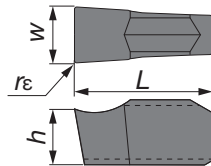

Designation	$W_0^{+0.025}$ (mm)	$W_0^{=0.001}$ (in)	$r\epsilon$ (in)	Uncoated	L (in)	h (in)
				KS05F		
GE20-AL	2	0.078	0.008	●	0.393	0.137
GE30-AL	3	0.118	0.008	●	0.393	0.138
GE40-AL	4	0.157	0.008	●	0.393	0.157

GF

For face grooving (Improved chip control)

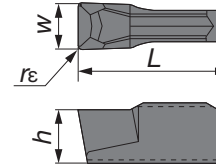

Designation	$W_0^{+0.1}$ (mm)	$W_0^{+0.004}$ (in)	$r\epsilon$ (in)	Coated		Cermet	L (in)	h (in)
				GH730	NS9530			
GF30	3	0.118	0.008	●	●		0.393	0.137
GF40	4	0.157	0.008	●	●		0.393	0.157
GF50	5	0.196	0.008	●	●		0.472	0.177

GE-R/L

For parting off (handed insert)

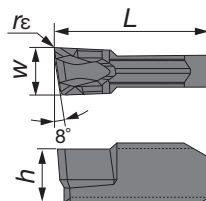

Right hand (R) shown.

Designation	$W_0^{+0.1}$ (mm)	$W_0^{+0.004}$ (in)	$r\epsilon$ (in)	Coated	L (in)	h (in)
				GH730		
GE30R/L	3	0.118	0.008	●	0.393	0.137
GE40R/L	4	0.157	0.008	●	0.393	0.157
GE50R/L	5	0.196	0.008	●	0.472	0.177

● : Line up

STANDARD CUTTING CONDITIONS



Workpiece material	Recommended grade	Cutting speed v_c (sfm)
Low carbon steels Alloy steels (~ HB150)	T9125	260 - 650
	NS9530	330 - 650
	GH730	160 - 590
Medium carbon steels Alloy steels (HB150 ~ 250)	T9125	260 - 590
	NS9530	260 - 590
	GH730	160 - 500
High carbon steels Alloy steels (HB250 ~)	T9125	260 - 500
	NS9530	260 - 500
	GH730	160 - 400
Stainless steels	T9125	260 - 500
	GH730	160 - 400
Gray and ductile cast irons	T9125	260 - 650
	GH730	160 - 590
Aluminum alloys, Non-ferrous metals	KS05F	200 - 300

For External

Operation	Feed: f (ipr)			
	Groove width: W (in)			
	0.078	0.118	0.157	0.196
Grooving (GE**)	0.002 - 0.008	0.002 - 0.009	0.002 - 0.010	0.002 - 0.012
Parting off (GE**/L)	0.001 - 0.003	0.001 - 0.006	0.001 ~ 0.006	0.001 - 0.006
Traversing (GT**)	-	Depth of cut $ap = 0.008 - 0.060$ $f = 0.002 - 0.006$	Depth of cut $ap = 0.020 - 0.078$ $f = 0.002 - 0.009$	Depth of cut $ap = 0.020 - 0.098$ $f = 0.002 - 0.010$
Profiling (GR**)	-	Depth of cut $ap = 0.050 - 0.055$ $f = 0.002 - 0.009$	Depth of cut $ap = 0.008 - 0.060$ $f = 0.002 - 0.010$	Depth of cut $ap = 0.020 - 0.062$ $f = 0.002 - 0.012$
Grooving for Aluminum alloys (GE**-AL)	0.001 - 0.003	0.001 - 0.003	0.001 - 0.003	-

- For diameter compensation values in traversing, see page C118.

For Face

Operation	Feed: f (ipr)		
	Groove width: W (in)		
	0.118	0.157	0.196
Face grooving (GE**)	0.002 - 0.009	0.002 - 0.009	0.003 - 0.016
Face grooving (GF**)	0.002 - 0.010	0.002 - 0.010	0.002 - 0.012
Face traversing (GT**)	Depth of cut $ap = 0.008 - 0.060$ $f = 0.002 - 0.006$	Depth of cut $ap = 0.020 - 0.078$ $f = 0.002 - 0.009$	Depth of cut $ap = 0.020 - 0.098$ $f = 0.002 - 0.010$
Face traversing (GR**)	Depth of cut $ap = 0.050 - 0.055$ $f = 0.002 - 0.009$	Depth of cut $ap = 0.008 - 0.060$ $f = 0.002 - 0.010$	Depth of cut $ap = 0.020 - 0.062$ $f = 0.002 - 0.012$
Face grooving for aluminum alloys (GE**-AL)	0.001 - 0.003	0.001 - 0.003	-

- For diameter compensation values in traversing, see page C118.
- For occurrence of vibrations in face traversing, set the feed to the lower side of the values show in the above table.

For Internal

Operation	Feed: f (ipr)		
	Groove width: W (in)		
	0.118	0.157	0.196
Face grooving (GE**)	0.002 - 0.006	0.002 - 0.006	0.002 - 0.006
Face grooving (GN**)	0.002 - 0.006	0.002 - 0.007	0.002 - 0.008
Face traversing (GT**)	$ap = 0.008 - 0.060$ $f = 0.002 - 0.006$	$ap = 0.020 - 0.078$ $f = 0.002 - 0.009$	$ap = 0.020 - 0.098$ $f = 0.002 - 0.010$
Face traversing (GR**)	$ap = 0.050 - 0.055$ $f = 0.002 - 0.009$	$ap = 0.008 - 0.060$ $f = 0.002 - 0.010$	$ap = 0.020 - 0.062$ $f = 0.002 - 0.012$
Face grooving for aluminum alloys (GE**-AL)	0.001 - 0.003	0.001 - 0.003	-

- For diameter compensation values in traversing, see page C118.
- For occurrence of vibrations in face traversing, set the feed to the lower side of the values show in the above table.



MY-T SERIES

CGWSR/L-CGD

External toolholders for grooving & parting

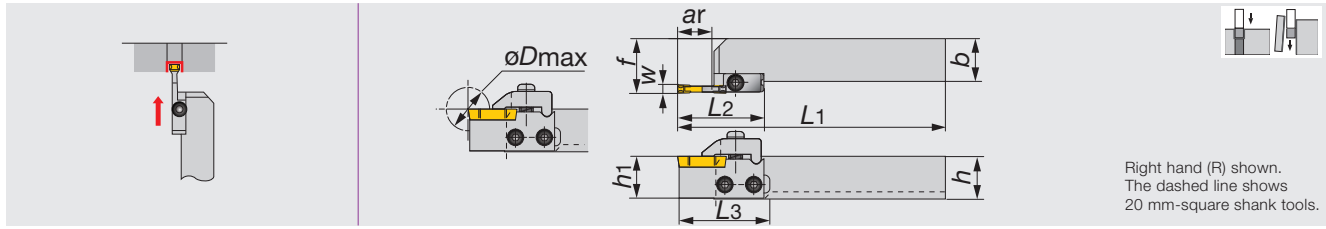

Metric	W	øDmax	ar	h	b	L1	L2	L3	h1	f	Insert	Shank	Blade*
CGWSR/L2020-CGDR/L2	2	35	16	20	20	152	45	48.5	20	26.45	CGD200	CGWSR/L2020	CGDR/L2
CGWSR/L2525-CGDR/L2	2	35	16	25	25	152	45	-	25	31.45	CGD200	CGWSR/L2525	CGDR/L2
CGWSR/L2020-CGDR/L3	3	46	21.6	20	20	157.6	50.6	54.1	20	26.45	CGD300	CGWSR/L2020	CGDR/L3
CGWSR/L2525-CGDR/L3	3	46	21.6	25	25	157.6	50.6	-	25	31.45	CGD300	CGWSR/L2525	CGDR/L3
CGWSR/L2020-CGDR/L4	4	46	21.6	20	20	157.6	50.6	54.1	20	26.65	CGD400	CGWSR/L2020	CGDR/L4
CGWSR/L2525-CGDR/L4	4	46	21.6	25	25	157.6	50.6	-	25	31.65	CGD400	CGWSR/L2525	CGDR/L4
CGWSR/L2020-CGDR/L5	5	46	21.6	20	20	157.6	50.6	54.1	20	26.95	CGD500	CGWSR/L2020	CGDR/L5
CGWSR/L2525-CGDR/L5	5	46	21.6	25	25	157.6	50.6	-	25	31.95	CGD500	CGWSR/L2525	CGDR/L5
CGWSR/L2020-CGDR/L6	6	46	21.6	20	20	157.6	50.6	54.1	20	27.1	CGD600	CGWSR/L2020	CGDR/L6
CGWSR/L2525-CGDR/L6	6	46	21.6	25	25	157.6	50.6	-	25	32.1	CGD600	CGWSR/L2525	CGDR/L6
CGWSR2525-8	7 / 8	50	21.6	25	25	150	-	-	25	26.35	CGD700, CGD800	-	-
CGWSR3232-8	7 / 8	50	21.6	32	32	170	-	-	32	33.35	CGD700, CGD800	-	-

When using a right or left hand blade set, the right hand blade set is used with right hand shank and the left hand blade set is used with left hand shank.
* Blade sold separately.

SPARE PARTS

Designation	Blade	Clamp	Clamping screw	Blade screw	Spring pin	Spring	Wrench
CGWSR****-CGDR2	TCR2	CCR2	RT-1	CSHB-6	-	BP-9	P-4
CGWSL****-CGDL2	TCL2	CCL2	RT-1	CSHB-6	-	BP-9	P-4
CGWSR****-CGDR3	TCR3	CCR3	RT-1	CSHB-6	-	BP-9	P-4
CGWSL****-CGDL3	TCL3	CCL3	RT-1	CSHB-6	-	BP-9	P-4
CGWSR****-CGDR4	TCR4	CCR4	RT-1	CSHB-6	-	BP-9	P-4
CGWSL****-CGDL4	TCL4	CCL4	RT-1	CSHB-6	-	BP-9	P-4
CGWSR****-CGDR5	TCR5	CCR5	RT-1	CSHB-6	-	BP-9	P-4
CGWSL****-CGDL5	TCL5	CCL5	RT-1	CSHB-6	-	BP-9	P-4
CGWSR****-CGDR6	TCR6	CCR6	RT-1	CSHB-6	-	BP-9	P-4
CGWSL****-CGDL6	TCL6	CCL6	RT-1	CSHB-6	-	BP-9	P-4
CGWSR****-8	-	CCR/L-8	CHHM6-20	-	5X14AW	BP-9	P-5



Reference pages

Inserts, Standard cutting conditions → C117

INSERT

CGD

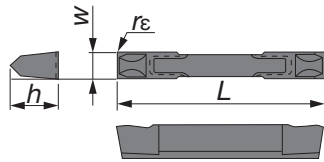

Designation	$W^{+0.025}$ (mm)	$W^{+0.001}$ (in)	$r\epsilon$ (in)	Coated			L (in)	h (in)
				GH330	Cermet NS9530	Uncoated UX30		
CGD200	2	0.078	0.008	●	●	●	0.787	0.128
CGD300	3	0.118	0.008	●	●	●	1.13	0.248
CGD400	4	0.157	0.008	●	●	●	1.13	0.248
CGD500	5	0.197	0.008	●	●	●	1.13	0.248
CGD600	6	0.236	0.008	●	●	●	1.13	0.335
CGD700	7	0.276	0.008	●		●	1.13	0.335
CGD800	8	0.315	0.008	●		●	1.13	0.335

● : Line up

STANDARD CUTTING CONDITIONS

Operation	Cutting speed V_c (sfm)	Groove width: W (in)						
		Feed: f (ipr)						
		0.078	0.118	0.157	0.197	0.236	0.276	0.315
Grooving Low Carbon Steels	330 - 650			0.003 - 0.010	0.003 - 0.010	0.003 - 0.010	0.003 - 0.010	0.003 - 0.010
Grooving Medium Carbon Steels		0.003 - 0.008	0.003 - 0.010	0.003 - 0.012	0.003 - 0.012	0.003 - 0.012	0.003 - 0.012	0.003 - 0.012
Parting off	100 - 150	0.003 - 0.006	0.003 - 0.006	0.003 - 0.006	0.003 - 0.006	0.003 - 0.006	0.003 - 0.006	0.003 - 0.006



Grooving Tool

MY-T SERIES



MY-T SERIES

CGWSR/L-FLR/L#GP

External toolholders for grooving & turning

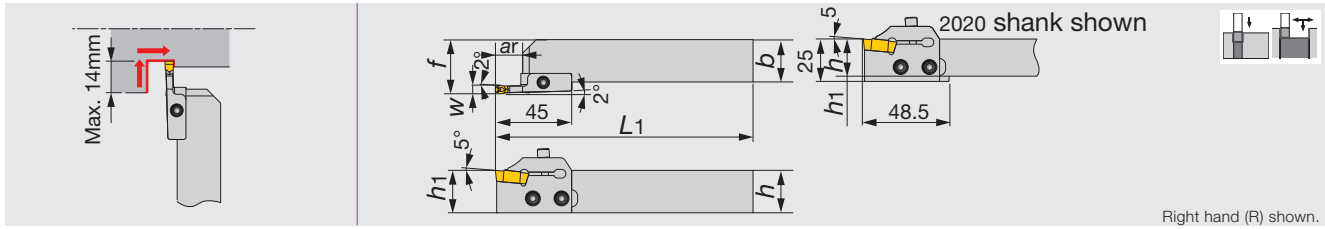

Metric	W	ar	h	b	L1	h1	f	Insert	Shank	Blade*
CGWSR/L2020-FLR/L3GP	3	10	20	20	152	20	27	FLEX30R/L	CGWSR/L2020	FLR/L3GP
CGWSR/L2525-FLR/L3GP	3	10	25	25	152	25	32	FLEX30R/L	CGWSR/L2525	FLR/L3GP
CGWSR/L2020-FLR/L4GP	4	12	20	20	152	20	27	FLEX40R/L	CGWSR/L2020	FLR/L4GP
CGWSR/L2525-FLR/L4GP	4	12	25	25	152	25	32	FLEX40R/L	CGWSR/L2525	FLR/L4GP
CGWSR/L2020-FLR/L5GP	5	14	20	20	152	20	27	FLEX50R/L	CGWSR/L2020	FLR/L5GP
CGWSR/L2525-FLR/L5GP	5	14	25	25	152	25	32	FLEX50R/L	CGWSR/L2525	FLR/L5GP

- When ordering, shank and blade assembly Designation or shank and blade-set are required.
- When using a right or left hand blade-set, the right hand blade-set is used with right hand shank and the left hand blade-set is used with left hand shank.
- * Blade sold separately.

SPARE PARTS

Designation	Clamping screw	Blade screw	Wrench
CGWSR/L***-FLR/L*GP	CHHM5-18	CSHB-6	P-4

Cautionary Notes

When performing OD machining, the tool point must be set at a right angle to the axial direction of the work.

- When replacing an insert, the replacement should be made only after completely removing any chips or other foreign matter from the tool clamping area on the holder by using compressed air, etc.
- Never tighten the insert mounting screws when an insert has not been installed since doing so can deform the screws and prevent the future installation of an insert.
- Flex-Tool has mechanism in which the end cutting edge angle is formed by accepting a cutting force. In external grooving, there is a possibility that if the cutting conditions (feed and depth of cut) are set too high, the programmed diameter will not be achieved. To prevent this problem, it is necessary to perform a compensation in the program by an amount that is equal to the amount A'-A that is shown in the drawing on the right. The values of compensation corresponding to the feeds are also shown in the graph.

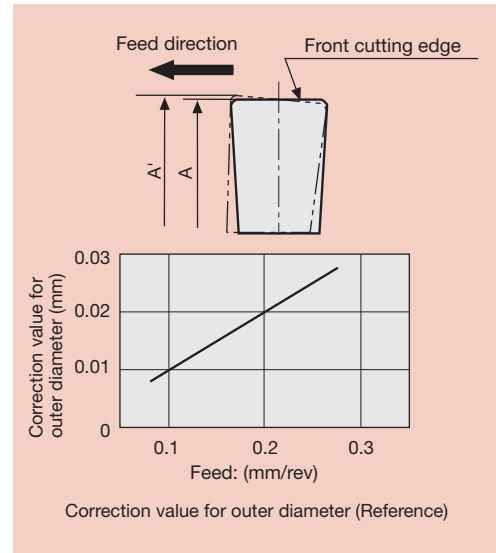

The length of blade for 5 mm width is shortened 2 mm compared from the old type blade. Please notice and read the instruction manual packaged in the box.

Reference pages

Inserts → C119

MY-T SERIES

CGWSR/L-FLR/L5TP

Toolholders for face grooving & turning

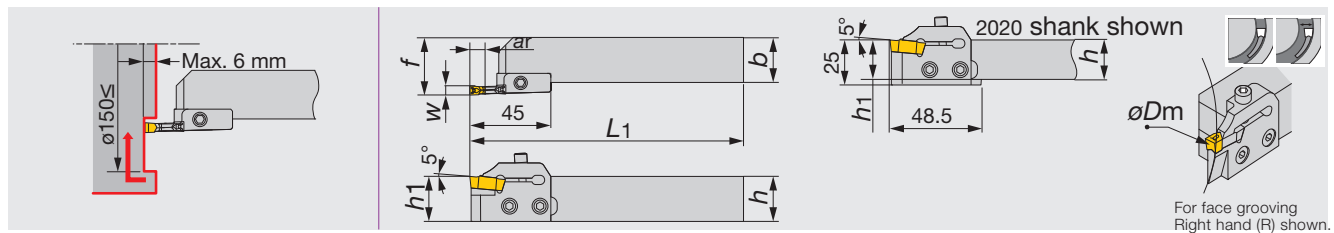

Metric	W	øDm	ar	h	b	L1	h1	f	Insert	Shank	Blade*
CGWSR/L2020-FLR/L5TP	5	150	6	20	20	152	20	27	FLEX50R/L	CGWSR/L2020	FLR/L5TP
CGWSR/L2525-FLR/L5TP	5	150	6	25	25	152	25	32	FLEX50R/L	CGWSR/L2525	FLR/L5TP

- When ordering, shank and blade assembly Designation or shank and blade set are required.
- When using a right or left hand blade set, the right hand blade set is used with right hand shank and the left hand blade set is used with left hand shank.
- * Blade sold separately.

SPARE PARTS

Designation	Clamping screw	Blade screw	Wrench
CGWSR/L***-FLR/L5TP	CHHM5-18	CSHB-6	P-4

MY-T SERIES

CGWTR/L0040-FLL/R3NP

Toolholders for internal grooving & turning

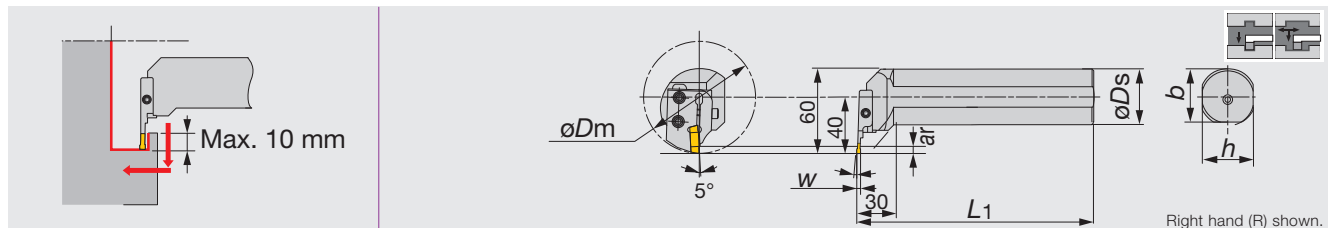

Metric	W	øDm	ar	øDs	L1	h	b	Insert	Shank	Blade*
CGWTR/L0040-FLL/R3NP	3	80	10	40	180	37.5	37	FLEX30L/R	CGWTR/L0040	FLL/R3NP

- When ordering, shank and blade assembly Designation or shank and blade set are required.
- When using a right or left hand blade set, the right hand blade set is used with left hand shank and the left hand blade set is used with right hand shank.
- * Blade sold separately.

SPARE PARTS

Designation	Clamping screw	Blade screw	Wrench
CGWTR/L0040-FLL/R3NP	CHHM5-18	CSHB-6	P-4

APPLICABLE INSERT

FLEX(R/L)

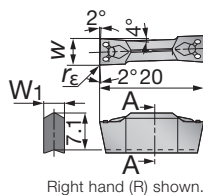

Right hand (R) shown.

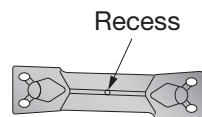

Left hand inserts are identified with a recessed dot.

Designation	w±0.05 (mm)	rE (mm)	Coated	Cermet	Uncoated	W1 (mm)
			T9125	NS9530	UX30	
FLEX30R/L	3	0.4		●		2.15
FLEX40R/L	4	0.4		●		3.1
FLEX50R/L	5	0.4	●	●	●	4

● : Line up



Grooving Tool

MY-T SERIES



Internal



Face Grooving

Others

CTWR/L

External toolholders for grooving & parting, with double-ended inserts

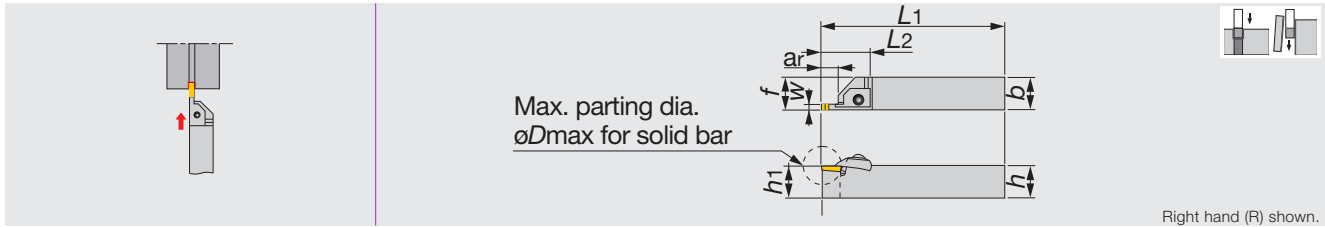

Right hand (R) shown.

Metric	W	øDmax	ar	h	b	L1	L2	h1	f	Insert
CTWR/L2020-3	3	32	14	20	20	150	41	20	20.25	CTD3
CTWR/L2525-3	3	32	14	25	25	150	41	25	25.25	CTD3
CTWR/L2020-4	4	32	14	20	20	150	41	20	20.25	CTD4
CTWR/L2525-4	4	32	14	25	25	150	41	25	25.25	CTD4
CTWR/L2525-5	5	42	20	25	25	150	46	25	25.25	CTD5

SPARE PARTS



Designation	Clamp	Pin	Clamping screw	Washer	Wrench
CTWR2020-3	CTC-3R	BP-360	CTS-M6	CDW6	P-4
CTWL2020-3	CTC-3L	BP-360	CTS-M6	CDW6	P-4
CTWR2525-3	CTC-3R	BP-360	CTS-M6	CDW6	P-4
CTWL2525-3	CTC-3L	BP-360	CTS-M6	CDW6	P-4
CTWR2020-4	CTC-4R	BP-360	CTS-M6	CDW6	P-4
CTWL2020-4	CTC-4L	BP-360	CTS-M6	CDW6	P-4
CTWR2525-4	CTC-4R	BP-360	CTS-M6	CDW6	P-4
CTWL2525-4	CTC-4L	BP-360	CTS-M6	CDW6	P-4
CTWR2525-5	CTC-5R	BP-360	CTS-M6	CDW6	P-4
CTWL2525-5	CTC-5L	BP-360	CTS-M6	CDW6	P-4

APPLICABLE INSERT

CTD

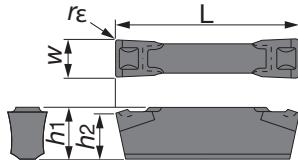

Designation	W±0.1 (mm)	rε (mm)	AH725	L (mm)	h1 (mm)	h2 (mm)
CTD3	3	0.2	●	20	4.3	4
CTD4	4	0.2	●	20	5.3	5
CTD5	5	0.2	●	25	6.3	6

● : Line up

STANDARD CUTTING CONDITIONS

Operation (Work materials)		Cutting speed vc (sfm)	Feed: f (ipr)		
			CTD3	CTD4	CTD5
Grooving	Low carbon steels	330 - 500	0.003 - 0.009	0.003 - 0.009	0.003 - 0.009
	Medium carbon steels		0.003 - 0.012	0.003 - 0.012	0.003 - 0.012
Parting off		330 - 500	0.003 - 0.006		

CTH

Blades for external grooving & parting

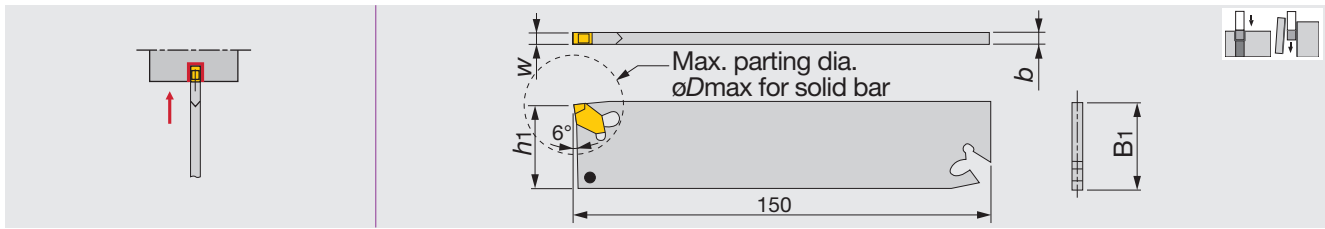

Metric	W	ϕD_{max}	b	h1	B1	Insert
CTH32-3	3	100	2.2	30.27	32.24	CT*3...
CTH32-4	4	100	3.2	30.13	31.97	CT*4...
CTH32-5	5	100	4.2	30	31.7	CT*5...
CTH32-6	6	100	5.2	29.87	31.44	CT*6...

SPARE PARTS

Designation	Wrench
CTH...	CTL-2



Grooving Tool



External



Parting-off

Reference pages

Inserts, Standard cutting conditions → **C124**



CTBN/S-32

Tool block for CTH blades

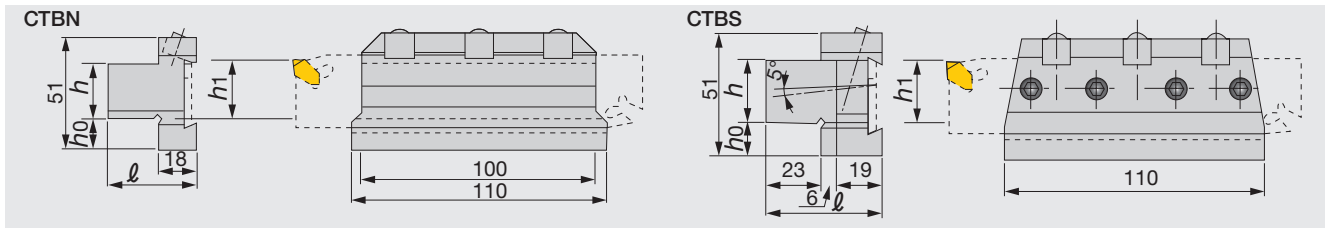

Metric	h	h1	h0	ℓ	Blade*
CTBN20-32	20	20.2	19.6	38	CTH32...
CTBN25-32	25	25.2	14.6	38	CTH32...
CTBN32-32	32	32.2	7.6	43	CTH32...
CTBS20-32	20	20.2	19.4	48	CTH32...
CTBS25-32	25	25.2	14.4	48	CTH32...
CTBS32-32	32	32.2	7.4	48	CTH32...

* Blade sold separately.

SPARE PARTS



Designation	Wedge clamping screw	Wedge	Wrench
CTBN**-32	NDS-8S	CTW-2	P-4
CTBS**-32	DS-8	CTW-2	P-4

CTSR/L

Blades for external grooving & parting

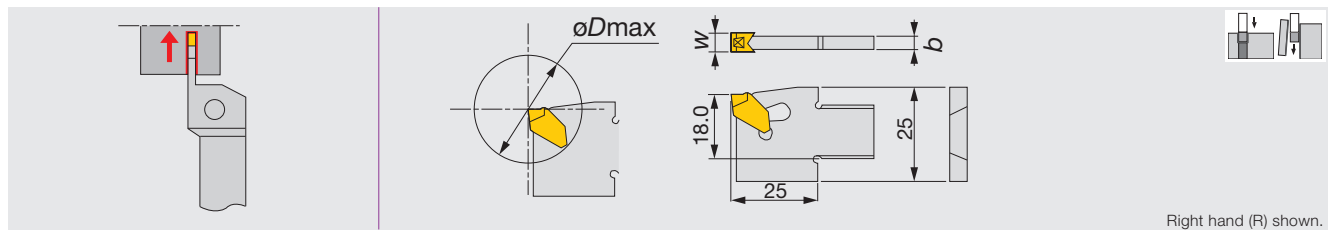

Metric	W	øDmax	b	Insert
CTSR/L25-3	3	50	2.2	CT*3...
CTSR/L25-4	4	50	3.2	CT*4...
CTSR25-5	5	50	4.2	CT*5...
CTSR25-6	6	50	5.2	CT*6...

• Refer to the assembly drawing of "CTBR/L" regarding the dimensions.

SPARE PARTS

Designation	Wrench
CTSR/L...	CTL-2

TOOLHOLDER

CTBR/L

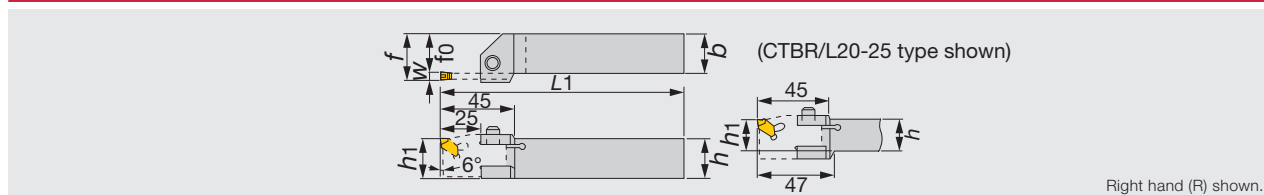

W	Metric	Blade	ar	h1	h	b	L1	f0	f
3,4	CTBR/L20-25	CTSR/L25-3/4	Max.25Max.cut off dia.ø50	20.2	20	25	150	19.6	22.6/23.6
3,4,5,6	CTBR/L25-25	CTSR/L25-3/4/5/6	Max.25Max.cut off dia.ø50	25.2	25	25	150	24.6	27.6/28.6/29.6/30.6

When using a right or left hand blade set, the right hand blade set is used with right hand shank and the left hand blade set is used with left hand shank.

SPARE PARTS

Designation	Clamping Screw	Wrench
CTBR/L...	M6×20	P-5

Reference pages

Inserts, Standard cutting conditions → C124

INSERT for CTH, CTS TYPE PARTING OFF TOOLHOLDER

CTN/CTR/CTL

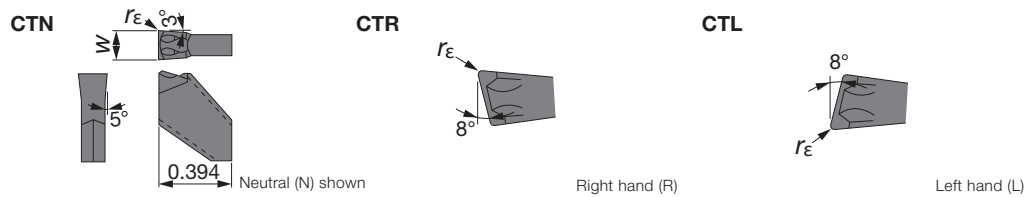

Designation	W±0.2 (mm)	W±0.008 (in)	rε (in)	Coated			Uncoated		
				T313W			TH10		
				N	R	L	N	R	L
CTN3	3	0.118	0.008	●					
CTR/L3	3	0.118	0.008		●	●			
CTN3K	3	0.118	0.008				●		
CTR/L3K	3	0.118	0.008					●	●
CTN4	4	0.157	0.008	●					
CTR/L4	4	0.157	0.008		●	●			
CTN4K	4	0.157	0.008				●		
CTR/L4K	4	0.157	0.008					●	●
CTN5	5	0.197	0.012	●					
CTR/L5	5	0.197	0.012		●				
CTN5K	5	0.197	0.012				●		
CTR/L5K	5	0.197	0.012					●	
CTN6	6	0.236	0.012	●					
CTN6K	6	0.236	0.012				●		

● : Line up

STANDARD CUTTING CONDITIONS FOR CTH, CTS

Operation / Workpiece material		Cutting speed v _c (sfm)	Feed: f (ipr)					
			CTN3	CTN4	CTN5	CTN6	CTR/L□	CT□□K
Grooving	Low carbon steels	330 - 500	0.003 - 0.009	0.003 - 0.009	0.003 - 0.009	0.003 - 0.012	-	-
	Medium carbon steels			0.003 - 0.012	0.003 - 0.012			
	Cast irons, Light alloys	330 - 660	-	-	-	-	0.004 - 0.006	
Parting off	Low carbon steels	330 - 500	0.003 - 0.008	0.003 - 0.008	0.003 - 0.008	0.003 - 0.008	0.003 - 0.006	-
	Medium carbon steels							
	Cast irons, Light alloys	330 - 660	-	-	-	-	0.004 - 0.012	

Note: When using CTS type (blade type) toolholders, reduce the values given in the table by 80 %.



The insert's secure & unique clamping guarantees reliable machining in grooving and turning

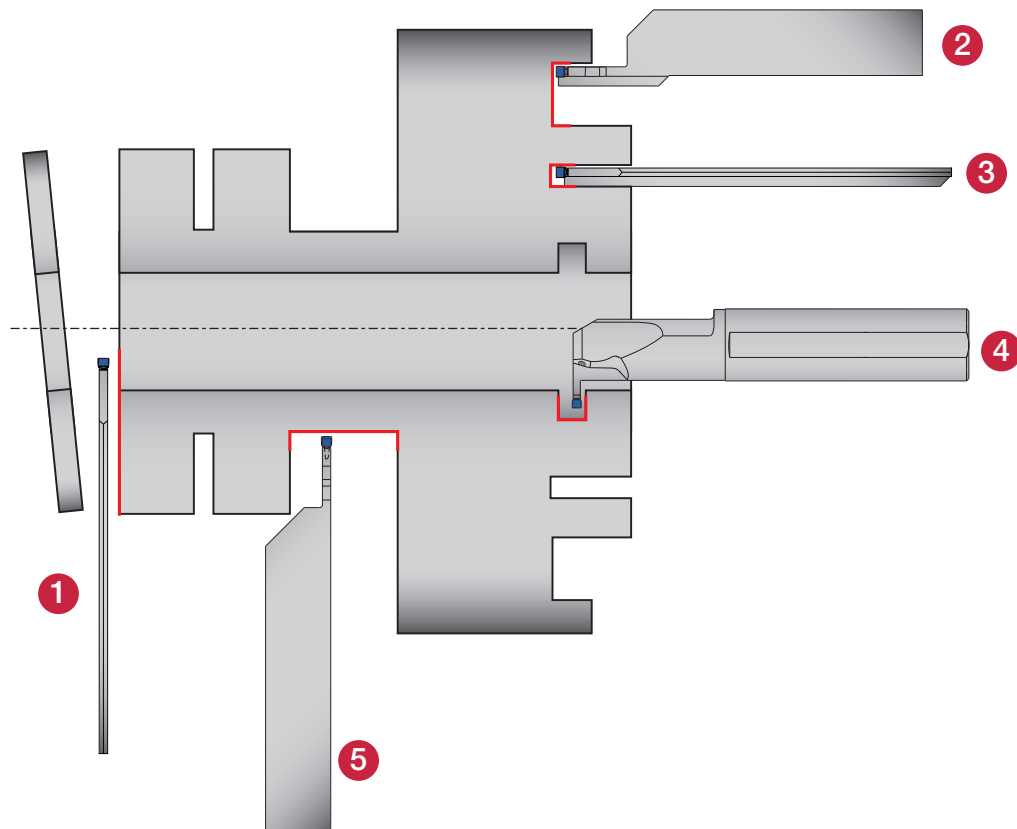

External



Internal



Face Grooving



Parting-off

Others

1 EGP

Blade type
 $W = 0.16'' - 0.24''$
 (4 - 6 mm)
 Max. parting Dia.:
 4.724" (120 mm)
 Shank size:
 $0.800'' - 0.126''$
 (20 - 32 mm)

Page C127

EGP-CHP

Blade type
 $W = 0.16'' - 0.24''$
 (4 - 6 mm)
 Max. parting Dia.:
 4.724" (120 mm)
 Shank size:
 $0.800'' - 0.126''$
 (20 - 32 mm)

Page C128

2 ETFR/L

$W = 0.16'' - 0.24''$
 (4 - 6 mm)
 $ar = 0.591'' - 1.260''$
 (15 - 32 mm)
 Shank size:
 $0.750'' - 1.000''$
 (20 - 25 mm)

Page C130

ETFR-CHP

$W = 0.16''$ (4 mm)
 Shank size:
 $0.800'' - 0.126''$
 (20 - 32 mm)
 Shank size: 1.000"
 (25 mm)

Page C131

3 EFPR/L

Blade type
 $W = 0.16'' - 0.24''$
 (4 - 6 mm)
 $ar = \text{Max.: } 2.559''$
 (65 mm)
 Shank size: 1.000"
 (25 mm)

Page C132

4 ETIR/L

$W = 0.16'' - 0.24''$
 (4 - 6 mm)
 $ar = 0.24'' - 0.433''$
 (6 - 11 mm)
 Shank size:
 $0.625'' - 1.250''$
 (16 - 32 mm)

Page C129

5 ETER/L

$W = 0.16'' - 0.24''$
 (4 - 6 mm)
 $ar = 0.984'' - 1.378''$
 (25 - 35 mm)
 Shank size:
 $0.750'' - 1.250''$
 (20 - 32 mm)

Page C126



Grooving Tool

EASyM^{ULTI} ETER/L

External toolholders for grooving & parting & turning

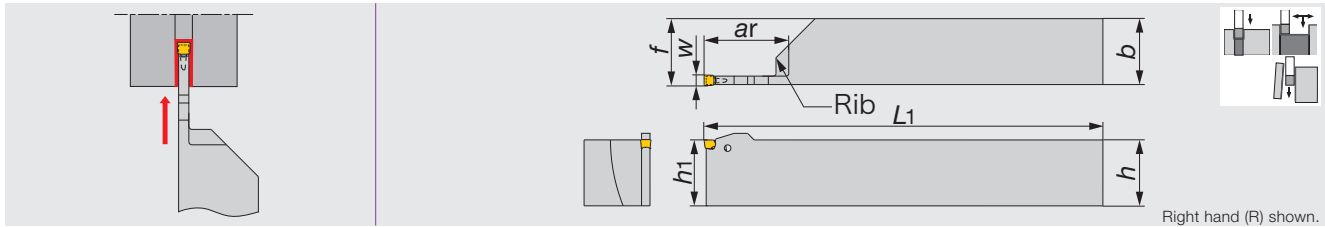

Inch	W	ar	h1	b	h	L1	f	Insert	Rib
ETER/L12-4T25	0.157	0.984	0.750	0.750	0.750	5.000	0.766	E**4...	Without
ETER/L16-4T25	0.157	0.984	1.000	1.000	1.000	6.000	1.016	E**4...	Without
ETER/L20-4T30	0.157	1.181	1.250	1.250	1.250	7.000	1.266	E**4...	Without
ETER/L12-5T25	0.197	0.984	0.750	0.750	0.750	5.000	0.766	ETX5...	Without
ETER/L16-5T32	0.197	1.260	1.000	1.000	1.000	6.000	1.016	ETX5...	Without
ETER/L20-5T32	0.197	1.260	1.250	1.250	1.250	7.000	1.266	ETX5...	Without
ETER/L16-6T35	0.236	1.378*	1.000	1.000	1.000	6.000	1.016	ETX6...	With
ETER/L20-6T35	0.236	1.378**	1.250	1.250	1.250	7.000	1.266	ETX6...	With

* Max. $\phi 6.69$ "
** Max. $\phi 13.38$ "



SPARE PARTS

Designation	Wrench (Optional parts)
ETER/L12-4T25	(ECW-456EF)
ETER/L16-4T25	(ECW-456EF)
ETER/L20-4T30	(ECW-456EF)
ETER/L12-5T25	(ECW-456EF)
ETER/L16-5T32	(ECW-456EF)
ETER/L20-5T32	(ECW-456EF)
ETER/L16-6T35	(ECW-456EF)
ETER/L20-6T35	(ECW-456EF)



External



Parting-off

Others

Reference pages

Inserts → C134 - C135, Standard cutting conditions → C135

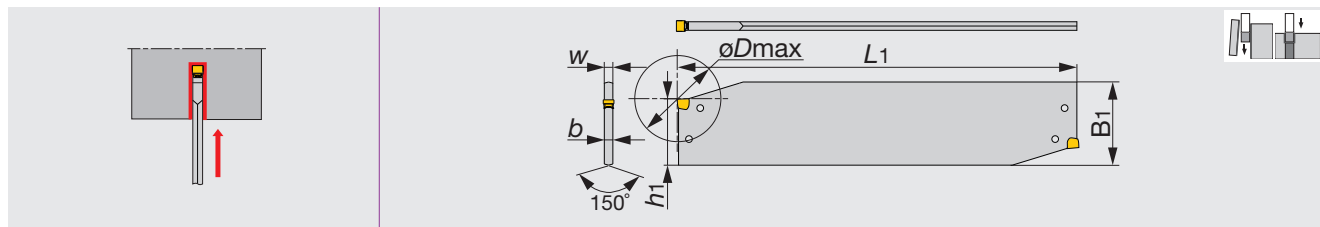

Inch	W	øDmax	h1	b	B1	L1	Insert
EGP26-4D	0.157	3.150	0.843	0.126	1.024	5.906	E**4...
EGP32-4D	0.157	3.937	0.980	0.126	1.260	5.906	E**4...
EGP32-5D	0.197	4.724	0.980	0.157	1.260	5.906	ETX5...
EGP32-6D	0.236	4.724	0.980	0.205	1.260	5.906	ETX6...

• øDmax: Max. parting off diameter

SPARE PARTS

Designation	Wrench (Optional parts)
EGP26-4D	(ECW-456EF)
EGP32-*D	(ECW-456EF)

EASYM^{ULTI}CUT

CTBU

Tool block for CGP and EGP blades

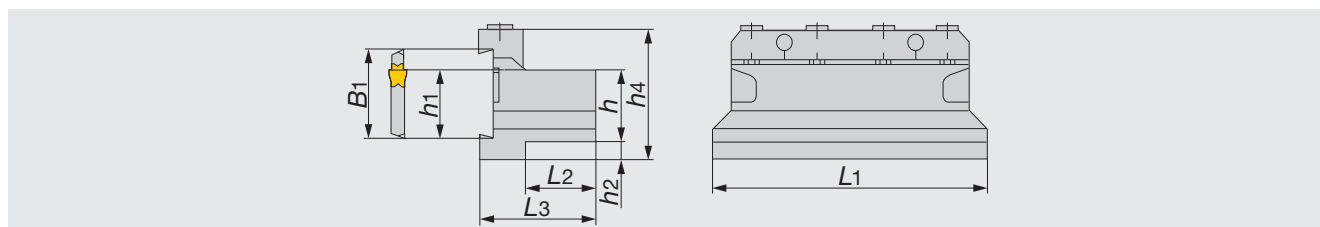

Inch	h1	B1	L1	h	h2	h4	L2	L3	Blade*
CTBU12-26-U	0.843	1.024	3.386	0.750	0.354	1.693	0.827	1.496	EGP26...
CTBU16-26-U	0.843	1.024	4.331	1.000	0.197	1.772	0.906	1.654	EGP26...
CTBU12-32-U	0.976	1.260	3.937	0.750	0.512	1.969	0.748	1.496	EGP32...
CTBU16-32-U	0.976	1.260	4.331	1.000	0.315	1.969	0.906	1.654	EGP32...
CTBU20-32-U	0.976	1.260	4.331	1.250	0.197	2.126	1.142	1.890	EGP32...

* Blade sold separately.

SPARE PARTS

Designation	Clamp	Clamping screw	Wrench
CTBU12-26-U	CT-86	CM6x30-S	P-5
CTBU16-26-U	CT-100	CM6x30-S	P-5
CTBU12-32-U	CT-105	CM6x30-S	P-5
CTBU16-32-U	CT-110	CM6x30-S	P-5
CTBU20-32-U	CT-110	CM6x30-S	P-5

Reference pages

Inserts → C134 - C135, Standard cutting conditions → C135



Grooving Tool

EASYM^{ULTI}CUT TUNG^{URN}TJET

EGP-CHP

Blades for external deep grooving & parting, with channels for high pressure coolant.

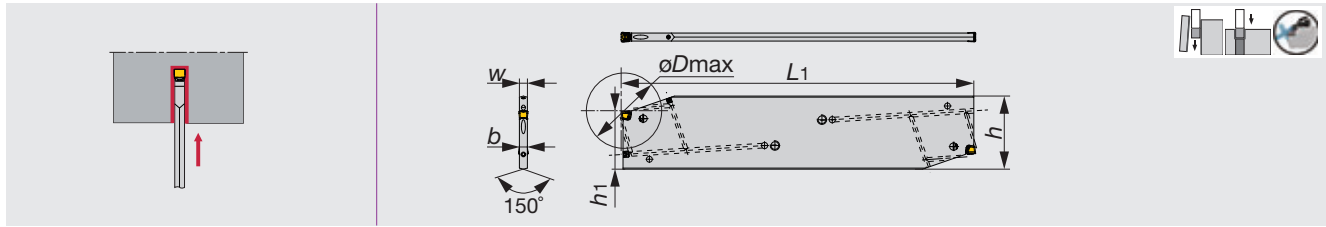

Metric	W	øDmax	ar	h	b	L1	h1	Insert
EGP32-4D-CHP	4	100	50	32	3.4	150	24.9	E**4...
EGP32-5D-CHP	5	120	60	32	4.2	160	24.9	ETX5...
EGP32-6D-CHP	6	120	60	32	5.2	160	24.9	ETX6...

• øDmax: Max. parting off diameter

SPARE PARTS

Designation	Sealing screw	Wrench (Optional parts)
EGP32-*D-CHP	SGC340	(ECW-456EF)

EASYM^{ULTI}CUT

CTBU-CHP

Tool blocks for external deep parting and grooving blades with channels for high pressure coolant

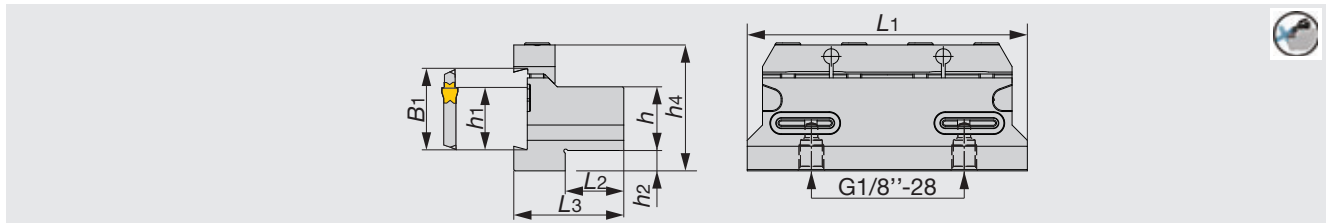

Inch	h	B1	L2	L1	h1	h2	h4	L3	Blade*
CTBU16-32-U-CHP	1.000	1.260	0.906	4.331	0.976	0.315	1.969	1.654	EGP32-*D-CHP

* Blade sold separately.

SPARE PARTS

Designation	Sealing screw	Clamp	Wrench	O-ring
CTBU16-32-U-CHP	SRM6X16DIN912-12.9	CT-110	P-5	OR14X2.5NN



External



Parting-off

Reference pages

Inserts → C134 - C135, Standard cutting conditions → C135

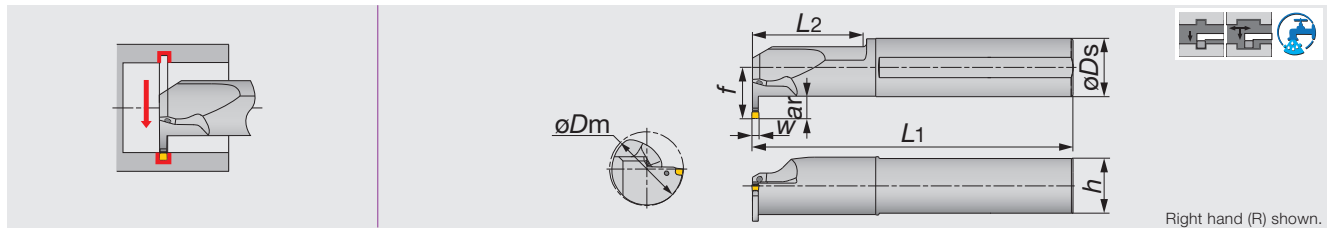

Inch	W	øDm	ar	øDs	h	L1	f	L2	Insert
ETIR/L10-4T06-D12	0.157	0.750	0.236	0.625	0.600	6.500	0.590	1.575	E**4...
ETIR/L12-4T06-D16	0.157	1.000	0.236	0.750	0.725	6.500	0.651	1.575	E**4...
ETIR/L16-4T09-D20	0.157	1.250	0.354	1.000	0.975	7.500	0.884	1.575	E**4...
ETIR/L20-4T11-D24	0.157	1.500	0.433	1.250	1.188	10.000	1.088	2.362	E**4...
ETIR/L20-5T11-D24	0.197	1.500	0.433	1.250	1.188	10.000	1.088	2.362	ETX5...
ETIR/L20-6T11-D24	0.236	1.500	0.433	1.250	1.188	10.000	1.098	2.362	ETX6...

• Wrench should be ordered separately.

SPARE PARTS

Designation	Seal cap (Optional parts: internal screw)	Wrench (Optional parts)
ETIR/L10-4T06-D12	CA-16(M6)	(ECW-456I)
ETIR/L12-4T06-D16	CA-20(M6)	(ECW-456I)
ETIR/L16-4T09-D20	CA-25(R1/8")	(ECW-456EF)
ETIR/L20-4T11-D24	CA-32(R1/8")	(ECW-456EF)
ETIR/L20-5T11-D24	CA-32(R1/8")	(ECW-456EF)
ETIR/L20-6T11-D24	CA-32(R1/8")	(ECW-456EF)



Grooving Tool

EASYMCUT^{ULTI}



Internal

Others

Reference pages

Inserts → **C134 - C135**, Standard cutting conditions → **C135**



Grooving Tool

EASYM^{ULTI}CUT ETFR/L

Toolholders for face grooving & turning

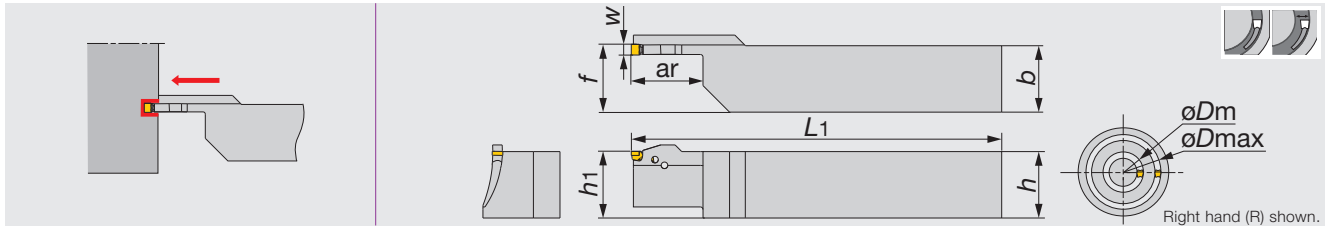

Inch	W	øDm	øDmax	ar	h	b	L1	h1	f	Insert
ETFR/L12-4T15-030035	0.157	1.181	1.378	0.591	0.750	0.750	0.750	5.000	0.770	E**4...
ETFR/L16-4T15-030035	0.157	1.181	1.378	0.591	1.000	1.000	1.000	6.000	1.020	E**4...
ETFR/L12-4T22-035045	0.157	1.378	1.772	0.866	0.750	0.750	0.750	5.000	0.770	E**4...
ETFR/L16-4T22-035045	0.157	1.378	1.772	0.866	1.000	1.000	1.000	6.000	1.020	E**4...
ETFR/L12-4T25-045055	0.157	1.772	2.165	0.984	0.750	0.750	0.750	5.000	0.770	E**4...
ETFR/L16-4T25-045055	0.157	1.772	2.165	0.984	1.000	1.000	1.000	6.000	1.020	E**4...
ETFR/L12-4T25-055075	0.157	2.165	2.953	0.984	0.750	0.750	0.750	5.000	0.770	E**4...
ETFR/L16-4T25-055075	0.157	2.165	2.953	0.984	1.000	1.000	1.000	6.000	1.020	E**4...
ETFR/L12-4T25-075120	0.157	2.953	4.724	0.984	0.750	0.750	0.750	5.000	0.770	E**4...
ETFR/L16-4T25-075120	0.157	2.953	4.724	0.984	1.000	1.000	1.000	6.000	1.020	E**4...
ETFR/L16-4T25-120200	0.157	4.724	7.874	0.984	1.000	1.000	1.000	6.000	1.020	E**4...
ETFR/L16-4T25-200500	0.157	7.874	19.685	0.984	1.000	1.000	1.000	6.000	1.020	E**4...
ETFR/L16-5T25-035045	0.197	1.378	1.772	0.984	1.000	1.000	1.000	6.000	1.020	ETX5...
ETFR/L16-5T25-045055	0.197	1.772	2.165	0.984	1.000	1.000	1.000	6.000	1.020	ETX5...
ETFR/L16-5T25-055075	0.197	2.165	2.953	0.984	1.000	1.000	1.000	6.000	1.020	ETX5...
ETFR/L16-5T32-075120	0.197	2.953	4.724	1.260	1.000	1.000	1.000	6.000	1.020	ETX5...
ETFR/L16-5T32-120200	0.197	4.724	7.874	1.260	1.000	1.000	1.000	6.000	1.020	ETX5...
ETFR/L16-5T32-200500	0.197	7.874	19.685	1.260	1.000	1.000	1.000	6.000	1.020	ETX5...
ETFR/L16-6T25-040055	0.236	1.575	2.165	0.984	1.000	1.000	1.000	6.000	1.020	ETX6...
ETFR/L16-6T25-055075	0.236	2.165	2.953	0.984	1.000	1.000	1.000	6.000	1.020	ETX6...
ETFR/L16-6T32-075120	0.236	2.953	4.724	1.260	1.000	1.000	1.000	6.000	1.020	ETX6...
ETFR/L16-6T32-120200	0.236	4.724	7.874	1.260	1.000	1.000	1.000	6.000	1.020	ETX6...
ETFR/L16-6T32-200500	0.236	7.874	19.685	1.260	1.000	1.000	1.000	6.000	1.020	ETX6...

SPARE PARTS



Designation	Wrench (Optional parts)
ETFR/L...	(ECW-456EF)



Face Grooving

Others

Reference pages

Inserts → **C134 - C135**, Standard cutting conditions → **C135**

Toolholders for face grooving & turning, with channels for high pressure coolant.

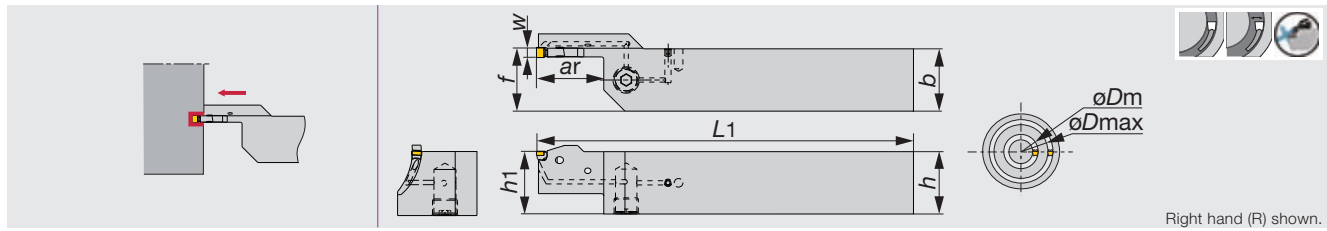

Inch	W	øDm	øDmax	ar	h	b	L1	h1	f	Insert
ETFR16-4T15-030035-CHP	0.157	1.181	1.378	0.591	1.000	1.000	6.000	1.000	1.020	E**4...
ETFR16-4T22-035045-CHP	0.157	1.378	1.772	0.866	1.000	1.000	6.000	1.000	1.020	E**4...
ETFR16-4T25-045055-CHP	0.157	1.772	2.165	0.984	1.000	1.000	6.000	1.000	1.020	E**4...
ETFR16-4T25-055075-CHP	0.157	2.165	2.953	0.984	1.000	1.000	6.000	1.000	1.020	E**4...
ETFR16-4T25-075120-CHP	0.157	2.953	4.724	0.984	1.000	1.000	6.000	1.000	1.020	E**4...
ETFR16-4T25-120200-CHP	0.157	4.724	7.874	0.984	1.000	1.000	6.000	1.000	1.020	E**4...
ETFR16-4T25-200500-CHP	0.157	7.874	19.685	0.984	1.000	1.000	6.000	1.000	1.020	E**4...

SPARE PARTS



Designation	Wrench (Optional parts)
ETFR****-CHP	(ECW-456EF)



Grooving Tool

EASYM^{ULTI}CUT



Face Grooving

Others

Reference pages

Inserts → C134 - C135, Standard cutting conditions → C135



Grooving Tool

EASYM^{ULTI}CUT

EFPR/L

Face grooving blade

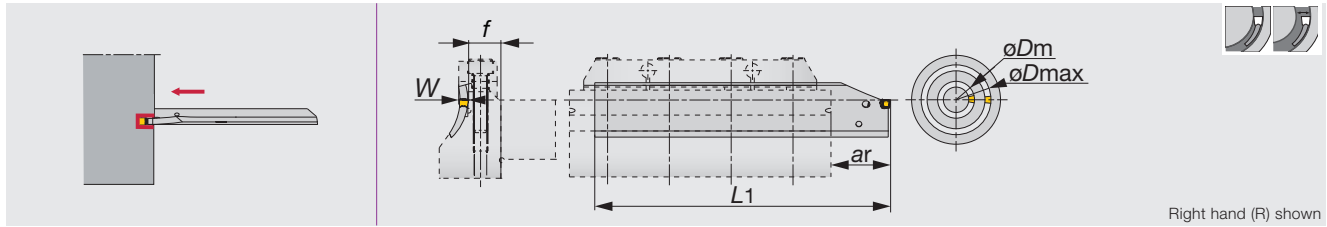

Inch	W	øDm	øDmax	f	L1	min ar	max ar	Insert
EFPR/L-4-030035	0.157	1.181	1.378	0.535	4.921	0.709	1.968	E**4...
EFPR-4-035045	0.157	1.378	1.772	0.535	4.921	0.709	1.968	E**4...
EFPR-4-045055	0.157	1.772	2.165	0.535	4.921	0.709	1.968	E**4...
EFPR-4-055075	0.157	2.165	2.953	0.535	4.921	0.709	1.968	E**4...
EFPR-4-075120	0.157	2.953	4.724	0.535	5.512	0.709	2.559	E**4...
EFPR-4-120200	0.157	4.724	7.874	0.535	5.512	0.709	2.559	E**4...
EFPR-4-200500	0.157	7.874	19.685	0.535	5.512	0.709	2.559	E**4...
EFPR-5-035045	0.197	1.378	1.772	0.535	4.921	0.748	1.968	ETX5...
EFPR-5-045055	0.197	1.772	2.165	0.535	4.921	0.748	1.968	ETX5...
EFPR-5-055075	0.197	2.165	2.953	0.535	4.921	0.748	1.968	ETX5...
EFPR-5-075120	0.197	2.953	4.724	0.535	5.512	0.748	2.559	ETX5...
EFPR-5-120200	0.197	4.724	7.874	0.535	5.512	0.748	2.559	ETX5...
EFPR-5-200500	0.197	7.874	19.685	0.535	5.512	0.748	2.559	ETX5...
EFPR-6-045055	0.236	1.772	2.165	0.535	4.921	0.787	1.968	ETX6...
EFPR-6-055075	0.236	2.165	2.953	0.535	4.921	0.787	1.968	ETX6...
EFPR-6-075120	0.236	2.953	4.724	0.535	5.512	0.787	2.559	ETX6...
EFPR-6-120200	0.236	4.724	7.874	0.535	5.512	0.787	2.559	ETX6...
EFPR/L-6-200500	0.236	7.874	19.685	0.535	5.512	0.787	2.559	ETX6...

SPARE PARTS



Designation	Wrench (Optional parts)
EFPR/L...	(ECW-456I)



Face Grooving

Others

Reference pages

Inserts → C134 - C135, Standard cutting conditions → C135

Tool block for EFP blades, with channels for high pressure coolant.



Grooving Tool

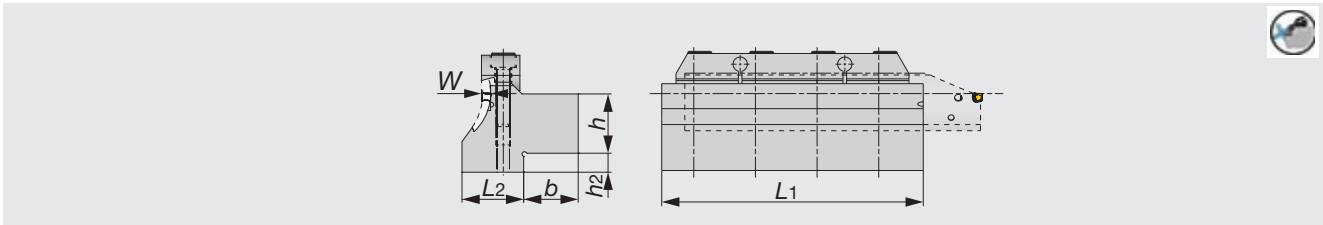

Inch	W	ϕD_m	h	b	h2	L2	L1	Blade*
CTBU16-030-4U-CHP	0.157	1.181	1.000	0.905	0.315	1.024	4.331	EFPR/L-4-030035
CTBU16-035-4/5U-CHP	0.157, 0.197	1.378	1.000	0.905	0.315	1.024	4.331	EFPR/L-4/5-035045
CTBU16-045-4/5U-CHP	0.157, 0.197	1.772	1.000	0.905	0.315	1.024	4.331	EFPR/L-4/5-045055
CTBU16-055-4/5U-CHP	0.157, 0.197	2.165	1.000	0.905	0.315	0.945	4.331	EFPR/L-4/5-055075
CTBU16-075-4/5U-CHP	0.157, 0.197	2.953	1.000	0.905	0.315	0.866	4.331	EFPR/L-4/5-075120
CTBU16-120-4/5U-CHP	0.157, 0.197	4.724	1.000	0.905	0.315	0.827	4.331	EFPR/L-4/5-120200
CTBU16-200-4/5U-CHP	0.157, 0.197	7.874	1.000	0.905	0.315	0.728	4.331	EFPR/L-4/5-200500
CTBU16-045-6U-CHP	0.236	1.772	1.000	0.905	0.315	1.102	4.331	EFPR/L-6-045055
CTBU16-055-6U-CHP	0.236	2.165	1.000	0.905	0.315	1.024	4.331	EFPR/L-6-055075
CTBU16-075-6U-CHP	0.236	2.953	1.000	0.905	0.315	0.945	4.331	EFPR/L-6-075120
CTBU16-120-6U-CHP	0.236	4.724	1.000	0.905	0.315	0.906	4.331	EFPR/L-6-120200
CTBU16-200-6U-CHP	0.236	7.874	1.000	0.905	0.315	0.807	4.331	EFPR/L-6-200500

* Blade sold separately.

SPARE PARTS



Designation	Clamp	Clamping screw	Wrench
CTBU...-CHP	CT-110	CM6X30-S	P-5

EASYMCUT^{ULTI}



Face Grooving

Others



ETX type



Page C135

Multi-functional insert
Well-balanced sharpness and strength

$W = 0.157'' - 0.236''$

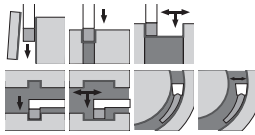

■ Standard feed for grooving

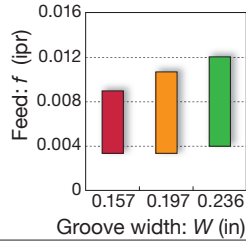

■ Standard feed and depth of cut for turning

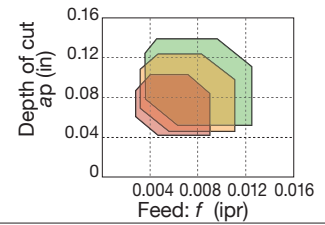

EGM type

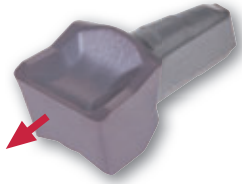

Page C135

First choice for parting off
Well-designed edge with high strength

$W = 0.157''$

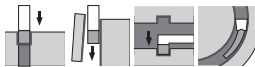

■ Standard feed for grooving

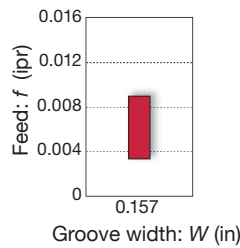

INSERT

ETX

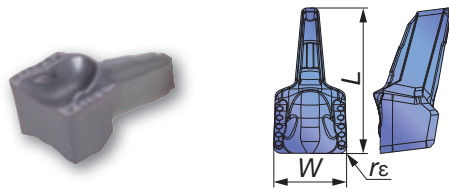

Designation	W±0.05 (mm)	W±0.002 (in)	rε (in)	AH725	L (in)
ETX4-040	4	0.157	0.016	●	0.315
ETX5-040	5	0.197	0.016	●	0.394
ETX6-040	6	0.236	0.016	●	0.472

● : Line up

EGM

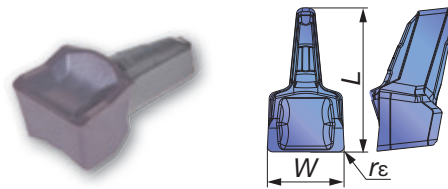

Designation	W±0.05 (mm)	W±0.002 (in)	rε (in)	AH725	L (in)
EGM4-030	4	0.157	0.012	●	0.315

● : Line up

STANDARD CUTTING CONDITIONS

ISO	Workpiece material	Hardness	Grades	Chip-breaker	Cutting speed Vc (sfm)
P	Low carbon steel (1018, 1020, 1026, etc.)	- 300 HB	AH725	ETX	160 - 600
		- 300 HB	AH725	EGM	160 - 600
	Carbon steel, Alloy steel (1045, 1055, etc.)	- 300 HB	AH725	ETX	160 - 600
		- 300 HB	AH725	EGM	160 - 600
	Prehardened steel (NAK80, PX5, etc.)	- 300 HB	AH725	ETX	160 - 600
		- 300 HB	AH725	EGM	160 - 600
M	Stainless steel (304SS, 316SS, 17-4 PH, etc.)	-	AH725	ETX	160 - 400
		-	AH725	EGM	160 - 400



Grooving Tool

EASYM^{ULTI}CUT



PROCEDURE TO CLAMP AND UNCLAMP INSERT

1 Put the insert in the pocket

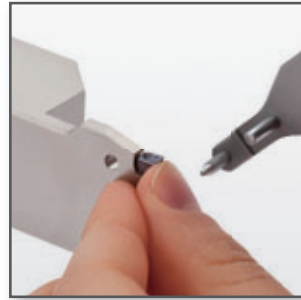
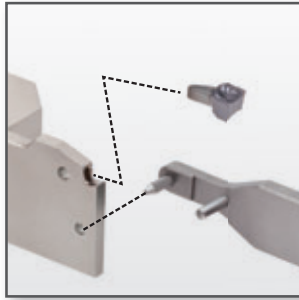

2 Turn the wrench and push the insert into the pocket to clamp



3 Unclamp

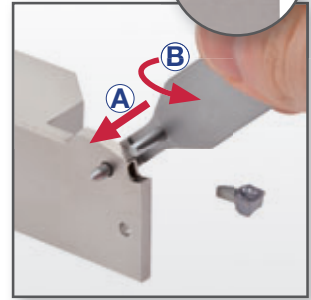

A Twist the wrench

B Push out the insert from the pocket to unclamp

PARTS FOR COOLANT HOSE

Connecting hose

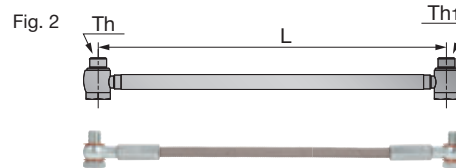
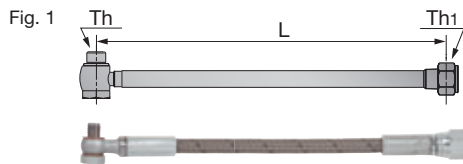

Metric	Length L	Threading size		Max. pressure (MPa)	Fig.
		Th	Th1		
CHP-HOSE-G1/8-7/16-200BS	200	G1/8"-28 BSPP	7/16"-20 UNF	26	1
CHP-HOSE-G1/8-7/16-250BS	250	G1/8"-28 BSPP	7/16"-20 UNF	26	1
CHP-HOSE-5/16-7/16-200BS	200	5/16"-24UNF	7/16"-20 UNF	20	1
CHP-HOSE-5/16-G1/8-200BS	200	5/16"-24UNF	G1/8"-28 BSPP	20	1
CHP-HOSE-G1/8-G1/8-200BB	200	G1/8"-28 BSPP	G1/8"-28 BSPP	26	2
CHP-HOSE-G1/8-G1/8-250BB	250	G1/8"-28 BSPP	G1/8"-28 BSPP	26	2

Connector

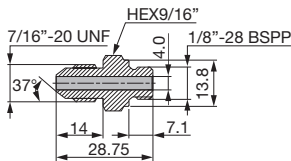

Metric
CHP-NIPPLE-G1/8-7/16UNF

Seal washer

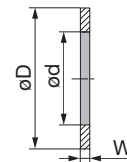

Metric	øD	ød	W
CHP-COPPER-SEAL1/8	15	10	1
CHP-COPPER-SEAL5/16	11	8	1
CHP-COPPER-SEAL5/16-2.5	11	8	2.5

Connector for small lathe with seal washer

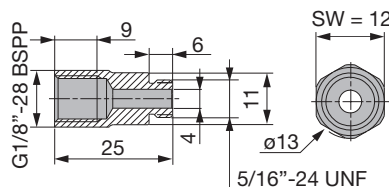

Metric
CHP-CONNECTOR/5/16-G1/8



Efficiently **reduces machining time** of wide width grooving and forming!

Effectively reduces the number of passes or machining time of complex profiles!

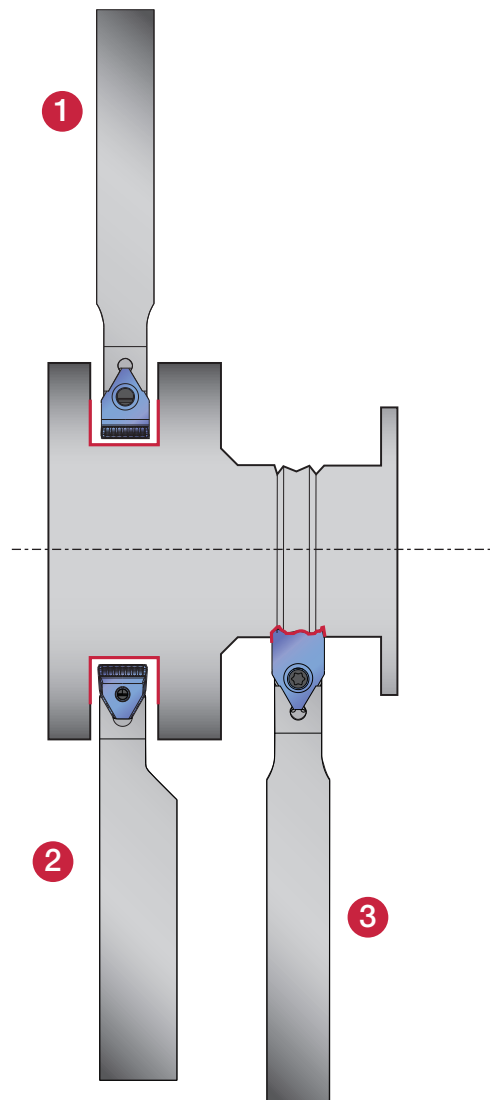

1 FPGN

Lever lock type
W = 0.394" - 0.984"
(10 - 25 mm)
ar = 0.787" - 1.614"
(20 - 36 mm)
Shank size:
0.500" - 1.000"
(12 - 25 mm)
Page C139

2 FPGR

Lever lock type
W = 0.394" - 0.984"
(10 - 25 mm)
ar = 0.787" - 2.615"
(20 - 50 mm)
Shank size:
1.000" - 1.500"
(25 - 40 mm)
Page C138

3 SPGN

Screw clamp type
W = 0.394" - 0.984"
(10 - 25 mm)
ar = 0.984" - 1.614"
(20 - 36 mm)
Shank size:
0.500" - 1.000"
(12 - 25 mm)
Page C139



TUNG H HEAVY GROOVE

FPGR

Lever lock type for external wide grooving and profiling

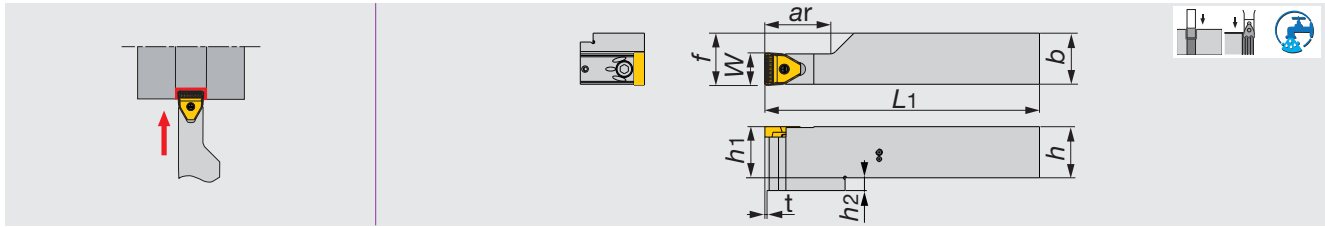

Inch	W	ar PSGB	ar PSGM	h1	b	h	L1 PSGB	L1 PSGM	f	h2	t PSGB	t PSGM	Insert ⁽¹⁾
FPGR16-10T20	0.394	0.984	0.787	1.000	1.000	1.000	7.196	7.000	1.020	-	0.216	0.019	PSG*10...
FPGR20-10T36	0.394	1.614	1.417	1.250	1.250	1.250	8.196	8.000	1.270	-	0.216	0.019	PSG*10...
FPGR16-15T20	0.590	0.984	0.787	1.000	1.000	1.000	7.196	7.000	1.020	-	0.216	0.019	PSG*15...
FPGR20-15T40	0.590	1.771	1.574	1.250	1.250	1.250	8.196	8.000	1.270	-	0.216	0.015	PSG*15...
FPGR20-20T40	0.787	1.771	1.574	1.250	1.250	1.250	8.196	8.000	1.270	0.314	0.216	0.015	PSG*20...
FPGR24-20T50	0.787	2.165	1.968	1.500	1.500	1.500	10.917	10.000	1.520	0.314	0.216	0.015	PSG*20...
FPGR20-25T40	0.984	1.771	1.574	1.250	1.250	1.250	8.196	8.000	1.270	0.314	0.216	0.015	PSG*25...
FPGR24-25T50	0.984	2.615	1.968	1.500	1.500	1.500	10.917	10.000	1.520	0.314	0.216	0.015	PSG*25...

(1) Can be used with both wide grooving and profile grooving inserts

SPARE PARTS



Designation	Lever	Clamping screw	Spring	Wrench
FPGR*****-10T..., 15T...	FCL4	FCS3	BP-5	P-2.5
FPGR*****-20T..., 25T...	FCL8	FCS6	BP-9	P-5



Reference pages

Inserts → C140 - C141, Standard cutting conditions → C141

Lever lock type for external wide grooving and profiling

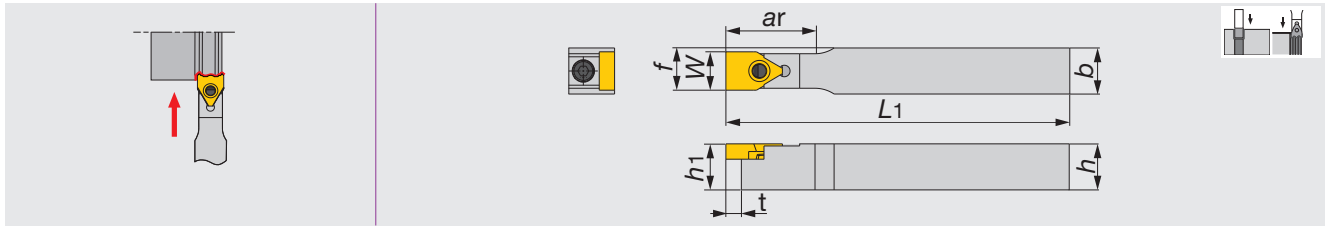

Inch	W	ar PSGB	ar PSGM	h1	b	h	L1 PSGB	L1 PSGM	f	t PSGB	t PSGM	Insert ⁽¹⁾
FPGN08-10T20	0.394	0.984	0.787	0.500	0.500	0.500	4.946	4.750	0.450	0.216	0.019	PSG*10...
FPGN10-10T20	0.394	0.984	0.787	0.625	0.625	0.625	4.946	4.750	0.510	0.216	0.019	PSG*10...
FPGN12-10T20	0.394	0.984	0.787	0.750	0.750	0.750	5.196	5.000	0.570	0.216	0.019	PSG*10...
FPGN10-15T25	0.590	1.181	0.984	0.625	0.625	0.625	4.946	4.750	0.610	0.216	0.015	PSG*15...
FPGN12-15T25	0.590	1.181	0.984	0.750	0.750	0.750	5.196	5.000	0.670	0.216	0.015	PSG*15...
FPGN12-20T32	0.787	1.456	1.259	0.750	0.750	0.750	5.196	5.000	0.770	0.216	0.015	PSG*20...
FPGN16-20T32	0.787	1.456	1.259	1.000	1.000	1.000	6.196	6.000	0.890	0.216	0.015	PSG*20...
FPGN16-25T36	0.984	1.614	1.417	1.000	1.000	1.000	6.196	6.000	0.990	0.216	0.015	PSG*25...

• We can make special shape with forming insert (PSGB type) responding to customer's request.(1) Can be used with both wide grooving and profile grooving inserts

SPARE PARTS



Designation	Lever	Clamping screw	Spring	Wrench
FPGN*****-10T..., 15T...	FCL4	FCS3	BP-5	P-2.5
FPGN*****-20T..., 25T...	FCL8	FCS6	BP-9	P-5

SPGN

Screw-on type, for external wide grooving and profiling

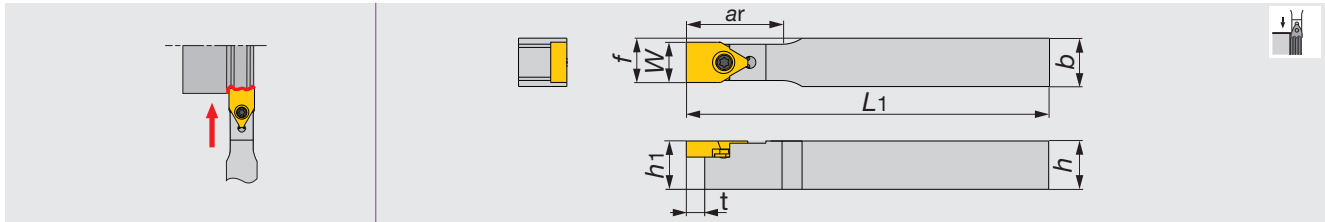

Inch	W	ar	h1	b	h	L1	f	t	Insert ⁽¹⁾
SPGN08-10T20	0.394	0.984	0.500	0.500	0.500	4.946	0.450	0.216	PSGB10
SPGN10-10T20	0.394	0.984	0.625	0.625	0.625	4.946	0.510	0.216	PSGB10
SPGN12-10T20	0.394	0.984	0.750	0.750	0.750	5.196	0.570	0.216	PSGB10
SPGN10-15T25	0.590	1.181	0.625	0.625	0.625	4.946	0.610	0.216	PSGB15
SPGN12-15T25	0.590	1.181	0.750	0.750	0.750	5.196	0.670	0.216	PSGB15
SPGN12-20T32	0.787	1.456	0.750	0.750	0.750	5.196	0.770	0.216	PSGB20
SPGN16-20T32	0.787	1.456	1.000	1.000	1.000	6.196	0.890	0.216	PSGB20
SPGN16-25T36	0.984	1.614	1.000	1.000	1.000	6.196	0.990	0.216	PSGB25

• We can make special shape with forming insert (PSGB type) responding to customer's request.(1) Can be used with profile grooving inserts, only

SPARE PARTS



Designation	Clamping screw	Wrench
SPGN*****-10T20	CSTB-3L081	T-8F
SPGN*****-15T25	CSTB-4	T-15F
SPGN*****-20T..., 25T...	CSTB-5	T-20F

Reference pages

Inserts → C140 - C141, Standard cutting conditions → C141



TUNGSTALOY ^{HEAVY}GROOVE - Chipbreaker Guide

PSGM



Page C141

For wide grooving
Excellent chip control

$W = 0.394" - 0.984"$
(10 mm - 25 mm)

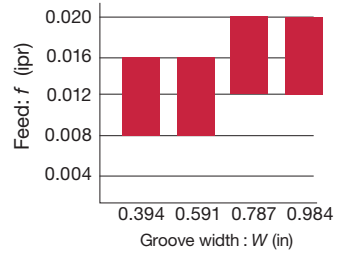

PSGB

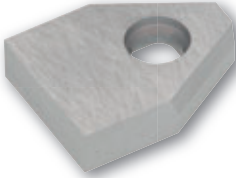

Page C141

Blank for profiling shape

$W = 0.402" - 0.992"$
(10.2 mm - 25.2 mm)

Specially tailored profile inserts



INSERT

For wide grooving

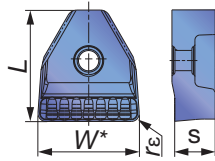

Designation	W* (mm)	W* (in)	rε (in)	Coated	L (in)	s (in)
				AH725		
PSGM10-08	10	0.394	0.032	●	0.433	0.157
PSGM15-15	15	0.590	0.059	●	0.591	0.197
PSGM20-20	20	0.787	0.079	●	0.866	0.256
PSGM25-20	25	0.984	0.079	●	0.866	0.256

*: Tolerance W ± 0.003 (W = 0.394), ± 0.004 (W ≥ 0.591) ● : Line up

Blanks for wide profile grooving*

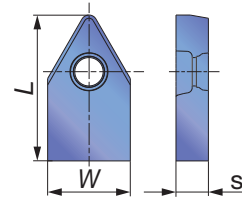

Designation	W ± 0.025 (mm) / W ± 0.001 (in)		Uncoated		L (in)	s (in)
	(mm)	(in)	UX30	TH10		
PSGB10	10.2	0.402	●	●	0.709	0.157
PSGB15	15.2	0.598	●	●	0.787	0.197
PSGB20	20.2	0.795	●	●	1.062	0.256
PSGB25	25.2	0.992	●	●	1.062	0.256

*Stocked products are blanks (semi-finished) for formed inserts ● : Line up

STANDARD CUTTING CONDITIONS

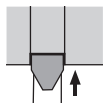

Wide grooving

ISO	Workpiece material	Hardness (HB)	Grade	Cutting speed Vc (sfm)
P	Alloy steel (4140, 8620, etc.)	< 300	AH725	165 - 590
	Alloy steel (4140, 8620, etc.)	< 300	UX30	165 - 390

PSGM type insert

Groove width: W (in)

	0.394	0.590	0.787	0.984
Feed: f (ipr)	0.008 - 0.016	0.008 - 0.016	0.012 - 0.020	0.012 - 0.020

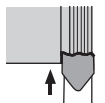

Forming

ISO	Workpiece material	Hardness (HB)	Grade	Cutting speed Vc (sfm)
P	Steel (1045, 1055, etc.)	< 200	UX30	165 - 490
	Alloy steel (4140, 8620, etc.)	< 300	UX30	165 - 390
M	Stainless steel (304SS, 316SS, 17-4 PH, etc.)	< 200	UX30	165 - 390
K	Gray cast iron (Class 25, Class 30, etc.)	-	TH10	165 - 490
	Ductile cast iron (60-40-18, 60-55-06, etc.)	-	TH10	165 - 390
N	Aluminum alloy (Si < 12%, etc.)	-	TH10	330 - 1640

■ Spare parts for internal coolant supply attachment (Order separately)

No.	Parts name	Designation	Note
①	Body	FPGR...	-
②	Insert	PSGM...	-
③	Coolant supply attachment	SGCU-341	-
④	Connector	Commercial items can be used	G 1/8 thread
			NPT 1/8 thread

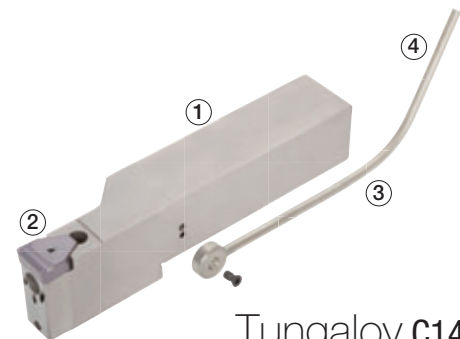

Tungaloy C141

MillLine





MILLING



 High-Feed Milling D002

 Shoulder Milling D032

 Face Milling D096

 Slot Milling D126

 Profile Milling D140

 Multi-Functional Milling D168

 Milling Insert D212

MillLine - High-Feed Milling

				Inch	Metric
	<p>HYBRIDTACMILL EXH</p> <p>High-feed endmills</p> <p>20° $\varnothing 0.394'' - \varnothing 0.625''$ ($\varnothing 10 - \varnothing 16$ mm) max. ap 0.031" (0.8 mm)</p> <p>P M K N</p>	<u>D004</u>	<input checked="" type="checkbox"/>	<input checked="" type="checkbox"/>	
	<p>DOFEED</p> <p>Super high-feed milling cutters with 4-cornered double-sided inserts</p> <p>15° $\varnothing 0.625'' - \varnothing 6.000''$ max. ap 0.059"</p> <p>P M K S H</p>	<u>D008</u>	<input checked="" type="checkbox"/>	<input checked="" type="checkbox"/>	
	<p>DOTWISTBALL</p> <p>Super high-feed cutters for profile milling with rigid clamping</p> <p>20° $\varnothing 1.000'' - \varnothing 2.000''$ max. ap 0.157"</p> <p>P M K S H</p>	<u>D016</u>	<input checked="" type="checkbox"/>	<input checked="" type="checkbox"/>	
	<p>DOFEEDQUAD</p> <p>Super high-feed cutters for face milling with 8-cornered double-sided inserts</p> <p>13° $\varnothing 2.000'' - \varnothing 6.000''$ max. ap 0.079"</p> <p>P M K S H</p>	<u>D021</u>	<input checked="" type="checkbox"/>	<input type="checkbox"/>	
	<p>MILLQFEED</p> <p>Super high-feed milling cutters for large depths of cut</p> <p>14° $\varnothing 2.000'' - \varnothing 6.000''$ max. ap 0.098"</p> <p>P M K S H</p>	<u>D024</u>	<input checked="" type="checkbox"/>	<input type="checkbox"/>	
	<p>MILLFEED TXP</p> <p>High-feed milling cutters with single-sided inserts</p> <p>10°-20° $\varnothing 0.750'' - \varnothing 6.000''$ max. ap 0.118"</p> <p>P M K H</p>	<u>D026</u>	<input checked="" type="checkbox"/>	<input type="checkbox"/>	
	<p>TUNGMEISTER</p> <p>Endmills with exchangeable heads for reduced tool change time $\varnothing 0.375'' - \varnothing 0.750''$</p> <p>P M K N S H</p>	<u>D181</u>	<input checked="" type="checkbox"/>	<input type="checkbox"/>	

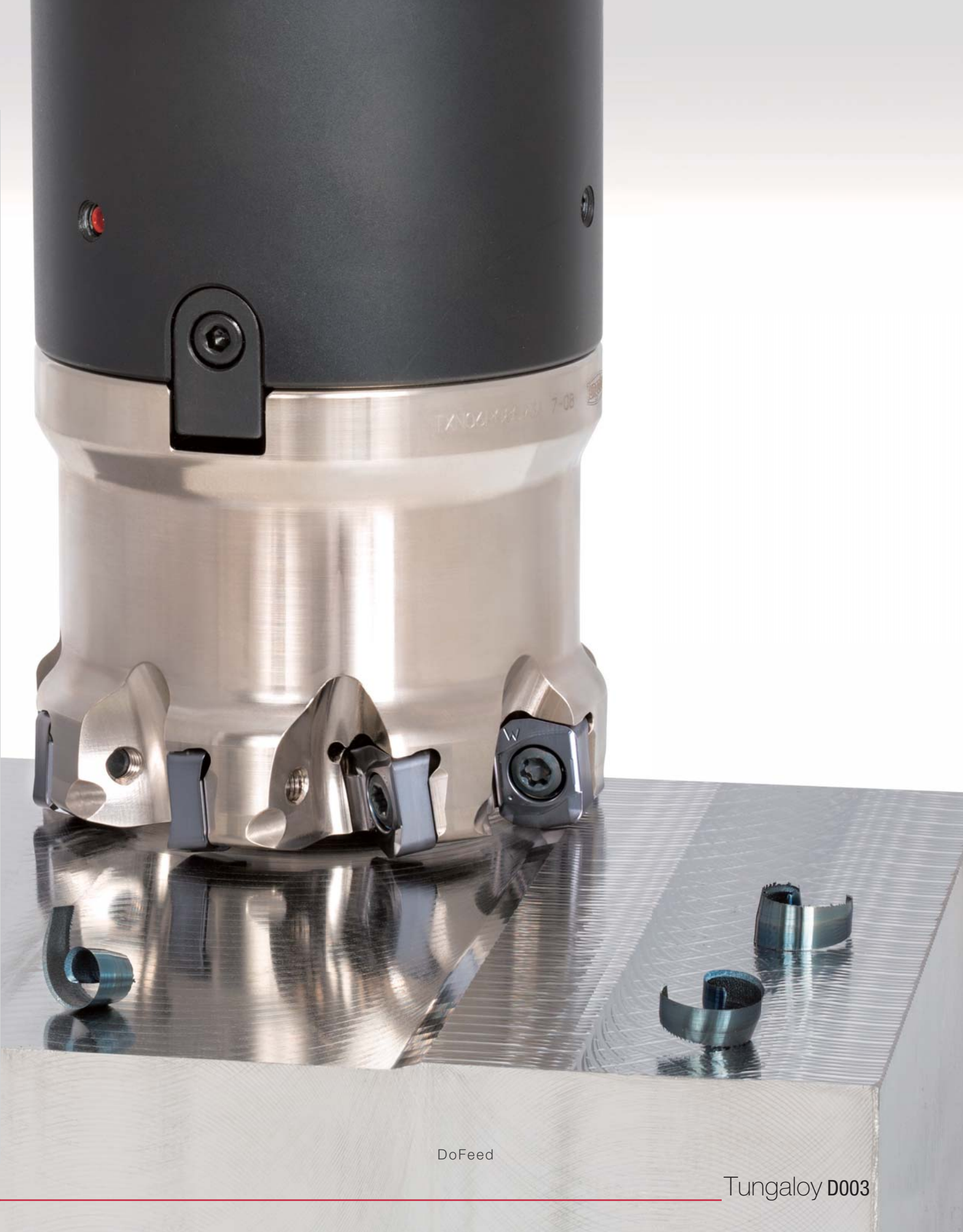

DoFeed

Tungaloy D003



HYBRIDTACMILL

EXH

Super high feed milling endmills with center cutting edge

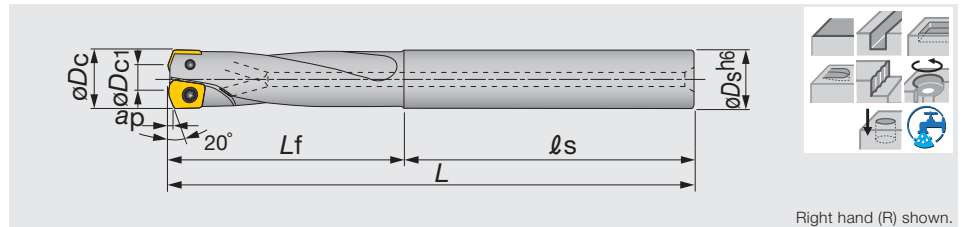

Inch	Max. a_p	ϕD_c	z	ϕD_{c1}	ϕD_s	L	L_f	ℓ_s	Insert
EXH06R039U0050-02	0.024	0.394	2	0.197	0.500	3.570	1.570	2.000	XXGT06H2...
EXH07R050U0050-02	0.024	0.500	2	0.276	0.500	4.000	2.000	2.000	XXGT07X3...
EXH09R063U0063-02	0.031	0.625	2	0.394	0.625	4.500	2.500	2.000	XXGT09X4...

Metric	Max. a_p	ϕD_c	z	ϕD_{c1}	ϕD_s	L	L_f	ℓ_s	Insert
EXH06R010M10.0-02	0.6	10	2	5	10	90	40	50	XXGT06H2...
EXH07R012M12.0-02	0.6	12	2	7	12	98	48	50	XXGT07X3...
EXH09R016M16.0-02	0.8	16	2	10	16	124	64	60	XXGT09X4...

SPARE PARTS



Designation	① Clamping screw	Lubricant	Wrench	Wrench 1
EXH06R...	CSPD-1.8S	M-1000	-	IP-6F
EXH07R...	CSPB-2H	M-1000	-	IP-6F
EXH09R...	CSPB-2.5S	M-1000	IP-8D	-

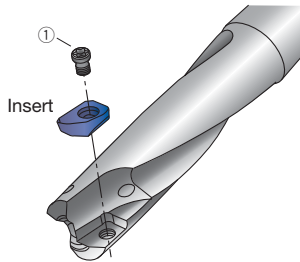

Reference pages

Inserts, Standard cutting conditions → **D005**

INSERT

XXGT EC-MJ (Center cutting edge)

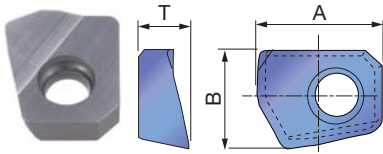

XXGT EP-MJ (Peripheral cutting edge)

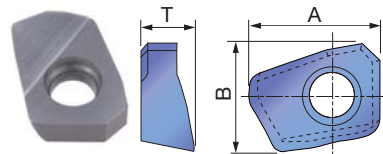

XXGT FC-AJ (Center cutting edge)

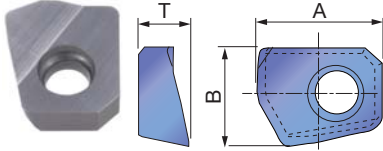

XXGT FP-AJ (Peripheral cutting edge)

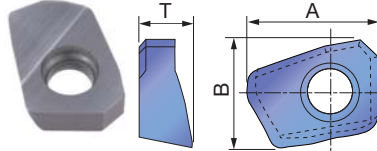

P	Steel	★																		
M	Stainless	★																		
K	Cast iron	★																		
N	Non-ferrous		★																	
S	Superalloys																			
H	Hard materials																			

★ : First choice
☆ : Second choice

Designation	Max. ap	Coated		A	B	T
		AH730	DS1200			
XXGT06H205EC-MJ	0.024	●		0.244	0.193	0.098
XXGT07X305EC-MJ	0.024	●		0.276	0.232	0.118
XXGT09X408EC-MJ	0.031	●		0.350	0.311	0.157
XXGT06H205FC-AJ	0.024		●	0.244	0.193	0.098
XXGT07X305FC-AJ	0.024		●	0.276	0.232	0.118
XXGT09X408FC-AJ	0.031		●	0.350	0.311	0.157
XXGT06H205EP-MJ	0.024	●		0.244	0.201	0.098
XXGT07X305EP-MJ	0.024	●		0.276	0.248	0.118
XXGT09X408EP-MJ	0.031	●		0.350	0.315	0.157
XXGT06H205FP-AJ	0.024		●	0.244	0.201	0.098
XXGT07X305FP-AJ	0.024		●	0.276	0.248	0.118
XXGT09X408FP-AJ	0.031		●	0.350	0.315	0.157

● : Line up

STANDARD CUTTING CONDITIONS

●Shoulder milling, Slotting

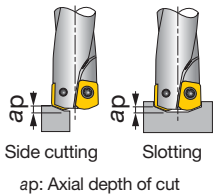

Workpiece material	Carbon steels and alloy steels		Alloy steels and prehardened steels		Stainless steels		Cast irons		Aluminum alloys (Si < 13%)		Aluminum alloys (Si ≥ 13%)		
	Hardness < 30HRC		30 ~ 40HRC		< 250HB		-		-		-		
Cutting speed	Vc = 330 - 1,000 sfm		Vc = 330 - 820 sfm		Vc = 330 - 1,000 sfm		Vc = 330 - 1,000 sfm		Vc = 330 - 1,650 sfm		Vc = 330 - 1,000sfm		
Conditions	No. of rev. n	Feed speed Vf	No. of rev. n	Feed speed Vf	No. of rev. n	Feed speed Vf	No. of rev. n	Feed speed Vf	No. of rev. n	Feed speed Vf	No. of rev. n	Feed speed Vf	
	rpm	ipm	rpm	ipm	rpm	ipm	rpm	ipm	rpm	ipm	rpm	ipm	
Tool dia. (in)	0.394	4770	56	3820	30	4770	56	6360	100	9550	226	6360	125
	0.500	3980	47	3180	25	3980	47	5300	83	7950	188	5300	104
	0.625	2980	35	2380	19	2980	35	3970	62	5960	141	3970	78
Depth of cut	0.394	ap < 0.024		ap < 0.020		ap < 0.024		ap < 0.024		ap < 0.024		ap < 0.024	
	0.500	ap < 0.024		ap < 0.020		ap < 0.024		ap < 0.024		ap < 0.024		ap < 0.024	
	0.625	ap < 0.031		ap < 0.024		ap < 0.031		ap < 0.031		ap < 0.031		ap < 0.031	

●Plunging



Workpiece material	Carbon steels and alloy steels		Alloy steels and prehardened steels		Stainless steels		Cast irons		Aluminum alloys (Si < 13%)		Aluminum alloys (Si ≥ 13%)		
	Hardness < 30HRC		30 ~ 40HRC		< 250HB		-		-		-		
Cutting speed	Vc = 330 - 1,000 SFM		Vc = 330 - 820 SFM		Vc = 330 - 1,000 SFM		Vc = 330 - 1,000 SFM		Vc = 330 - 1,650 SFM		Vc = 330 - 1,000 SFM		
Conditions	No. of rev. n	Feed speed Vf	No. of rev. n	Feed speed Vf	No. of rev. n	Feed speed Vf	No. of rev. n	Feed speed Vf	No. of rev. n	Feed speed Vf	No. of rev. n	Feed speed Vf	
	rpm	ipm	rpm	ipm	rpm	ipm	rpm	ipm	rpm	ipm	rpm	ipm	
Tool dia. (in)	0.394	4770	9	3820	6	4770	9	6360	17	9550	30	6360	17
	0.500	3980	8	3180	5	3980	8	5300	15	7950	25	5300	15
	0.625	2980	6	2380	4	2980	6	3970	11	5960	19	3970	11

Note: ● In slotting or pocketing where chips tend to stay in the cutting zone, use an air blast to remove chips for preventing chip recutting.
● When chips tend to weld excessively on the cutting edge such as in machining aluminum alloys, use a water soluble cutting fluid.
● In the case of cutting a casting skin or a heavily interrupted work surface, decrease the feed per tooth and the maximum depth of cut to 1/2 to 2/3 times the values shown in the table.

● Tool overhang length must be as short as possible to avoid chatter. When the tool overhang length is long, decrease the number of revolutions and feed.
● Cutting conditions are generally limited by the rigidity and power of the machine and the rigidity of the workpiece. When setting the conditions, start from half of the values of the standard cutting conditions and then increase the value gradually while making sure that the machine is running normally.

APPLICATION RANGE

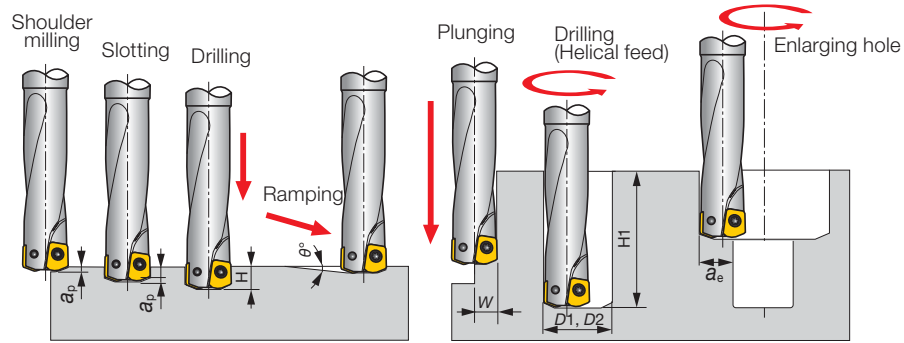

	Tool dia.	Max. depth of cut	Max. depth of drilling	Max. cutting width in plunging	Max. ramping angle	Min. machinable hole dia.	Max. machinable hole dia.	Max. cutting width in enlarging hole	Max. depth of boring
Inch	ϕDc	ap	H	W	θ°	D1	D2	ae	H1
EXH06R039U0050-02	0.394	0.236	0.197	0.197	5	0.472	0.748	0.276	1.250
EXH07R050U0050-02	0.500	0.236	0.236	0.236	5	0.551	0.906	0.354	1.420
EXH09R063U0063-02	0.625	0.315	0.315	0.315	5	0.709	1.220	0.492	1.890

	Tool dia.	Max. depth of cut	Max. depth of drilling	Max. cutting width in plunging	Max. ramping angle	Min. machinable hole dia.	Max. machinable hole dia.	Max. cutting width in enlarging hole	Max. depth of boring
Metric	ϕDc	ap	H	W	θ°	D1	D2	ae	H1
EXH06R010M10.0-02	10	0.6	5	5	5	12	19	7	30
EXH07R012M12.0-02	12	0.6	6	6	5	14	23	9	36
EXH09R016M16.0-02	16	0.8	8	8	5	18	31	12.5	48

TOOL GEOMETRY FOR PROGRAMMING

When using CAD/CAM, please program it for radius cutter. The following table shows actual cutting edge geometry and amount of unfinished work cut.

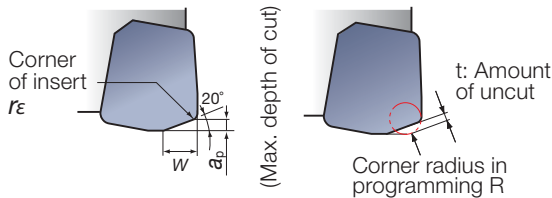

	Max. depth of cut	Corner of insert	Width	Amount of uncut	Corner radius in programming
Inch	ap	$r\epsilon$	W	t	R
EXH06R039U0050-02	0.024	0.020	0.098	0.028	R.020
				0.024	R.039
				0.024	R.020
EXH07R050U0050-02	0.024	0.020	0.098	0.028	R.020
				0.024	R.039
				0.024	R.020
EXH09R063U0063-02	0.031	0.031	0.118	0.031	R.020
				0.028	R.039
				0.024	R.060

	Max. depth of cut	Corner of insert	Width	Amount of uncut	Corner radius in programming
Metric	ap	$r\epsilon$	W	t	R
EXH06R010M10.0-02	0.6	0.5	2.5	0.7	R0.5
				0.6	R1.0
				0.6	R0.5
EXH07R012M12.0-02	0.6	0.5	2.5	0.7	R0.5
				0.6	R1.0
				0.6	R0.5
EXH09R016M16.0-02	0.8	0.8	3	0.8	R0.5
				0.7	R1.0
				0.6	R1.5



MEMO

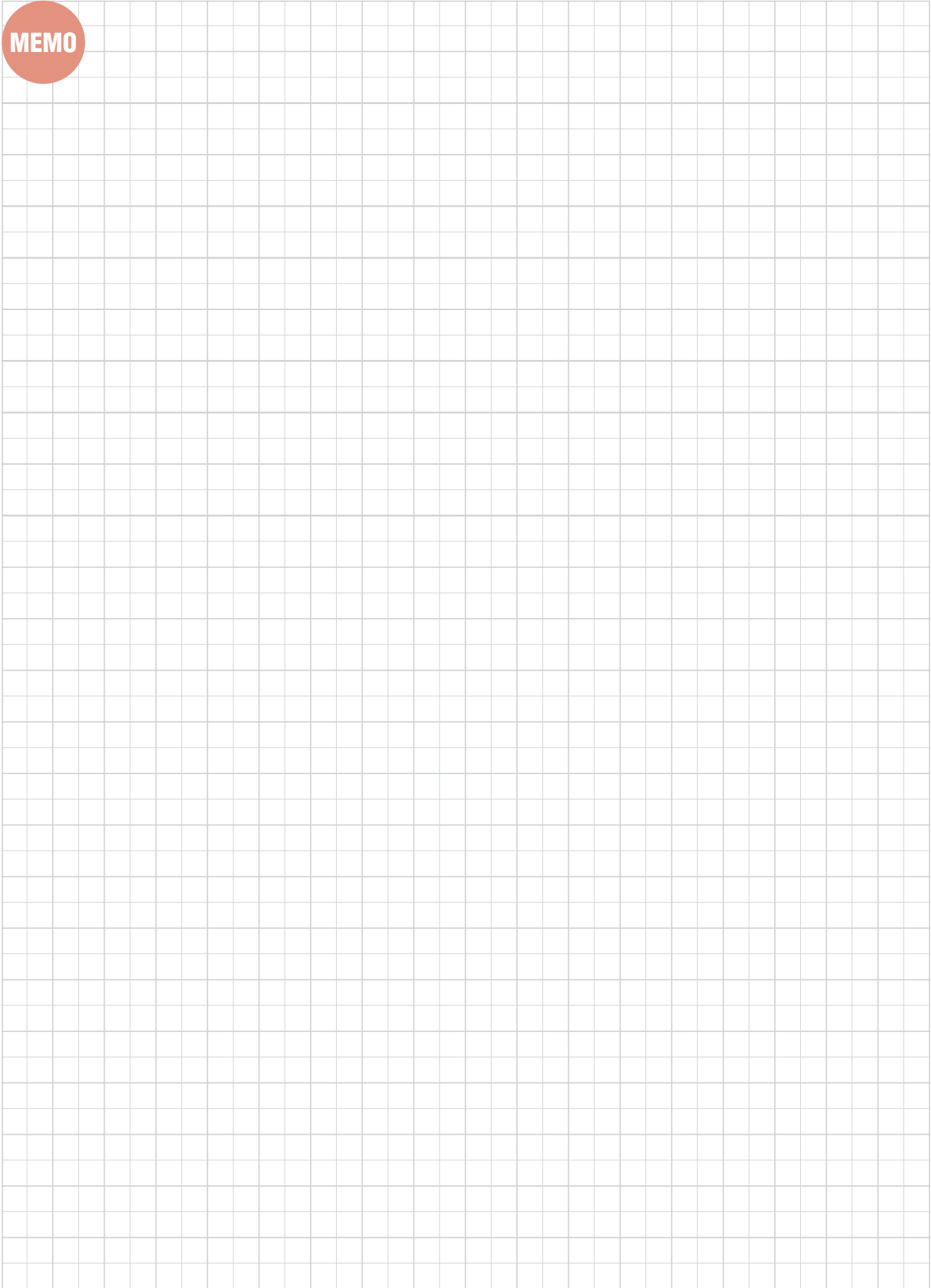

DOFEED TXN03

Super high feed milling cutters with double sided inserts with 4 edges

A.R. = +6°, R.R. = +12° ~ 13°

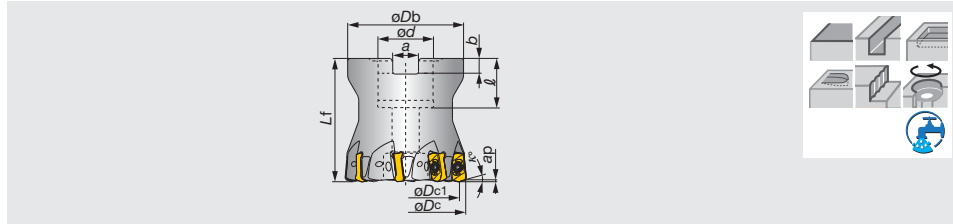

Inch	Max. ap	ϕD_c	z	ϕD_{c1}	ϕD_b	ϕd	ℓ	L_f	b	a	κ°	lb	Air hole	Insert
TXN03R150U0050A05	0.039	1.500	5	1.248	1.460	0.500	0.750	1.575	0.160	0.252	17	0.530	with	LNMU03...
TXN03R150U0050A06	0.039	1.500	6	1.248	1.380	0.500	0.600	1.575	0.160	0.252	17	0.510	with	LNMU03...
TXN03R200U0075A05	0.039	2.000	5	1.718	1.693	0.750	0.750	1.969	0.197	0.315	17	1.100	with	LNMU03...
TXN03R200U0075A08	0.039	2.000	8	1.718	1.693	0.750	0.750	1.969	0.197	0.315	17	1.100	with	LNMU03...
TXN03R200U0075A10	0.039	2.000	10	1.718	1.693	0.750	0.750	1.969	0.197	0.315	17	1.100	with	LNMU03...

SPARE PARTS

Designation	Clamping screw	Lubricant	Wrench	Center bolt (Optional parts)
TXN03...	CSPB-2.5	M-1000	IP-8D	(C0.375X1.125H)

DOFEED EXN03

Super high feed milling endmills with double sided inserts with 4 edges

A.R. = +6°, R.R. = +5° ~ +11°

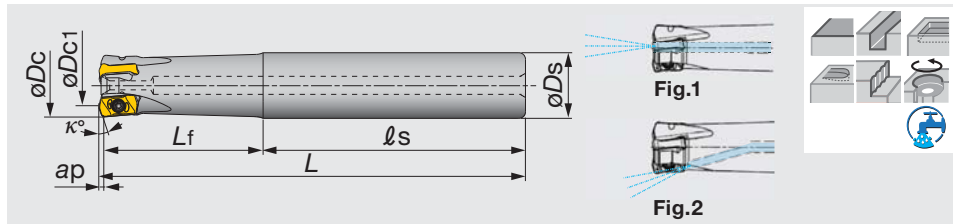

Inch	Max. ap	ϕD_c	z	ϕD_{c1}	ϕD_s	L	L_f	ℓ_s	κ°	lb	Air hole	Insert	Fig.
EXN03R062U0062-02	0.039	0.625	2	0.372	0.625	4.000	1.250	2.750	15	0.310	with	LNMU03...	1
EXN03R062U0062-02L	0.039	0.625	2	0.372	0.625	6.000	2.000	4.000	15	0.460	with	LNMU03...	1
EXN03R068U0062-02	0.039	0.688	2	0.434	0.625	4.000	1.250	2.750	17	0.310	with	LNMU03...	1
EXN03R068U0062-02L	0.039	0.688	2	0.434	0.625	6.000	1.000	5.000	17	0.490	with	LNMU03...	1
EXN03R075U0075-02	0.039	0.750	2	0.495	0.750	5.000	2.000	3.000	17	0.550	with	LNMU03...	1
EXN03R075U0075-03	0.039	0.750	3	0.495	0.750	5.000	2.000	3.000	17	0.550	with	LNMU03...	1
EXN03R075U0075-03L	0.039	0.750	3	0.495	0.750	6.500	3.500	3.000	17	0.710	with	LNMU03...	1
EXN03R075U0075-03-C	0.039	0.750	3	0.494	0.750	5.000	2.000	3.000	17	0.660	with	LNMU03...	2
EXN03R087U0075-02	0.039	0.875	2	0.621	0.750	5.000	2.000	3.000	17	0.570	with	LNMU03...	1
EXN03R087U0075-03	0.039	0.875	3	0.621	0.750	5.000	2.000	3.000	17	0.570	with	LNMU03...	1
EXN03R087U0075-03L	0.039	0.875	3	0.621	0.750	6.500	1.250	5.250	17	0.750	with	LNMU03...	1
EXN03R087U0075-03-C	0.039	0.875	3	0.634	0.750	5.000	2.000	3.000	17	0.660	with	LNMU03...	2
EXN03R100U0100-04	0.039	1.000	4	0.746	1.000	5.500	2.500	3.000	17	1.080	with	LNMU03...	1
EXN03R100U0100-04L	0.039	1.000	4	0.746	1.000	7.000	4.000	3.000	17	1.340	with	LNMU03...	1
EXN03R100U0100-05	0.039	1.000	5	0.746	1.000	5.500	2.500	3.000	17	1.080	with	LNMU03...	1
EXN03R100U0100-05-C	0.039	1.000	5	0.756	1.000	5.500	2.500	3.000	17	1.100	with	LNMU03...	2
EXN03R112U0100-04	0.039	1.125	4	0.871	1.000	5.500	2.500	3.000	17	1.120	with	LNMU03...	1
EXN03R112U0100-04L	0.039	1.125	4	0.871	1.000	7.000	1.500	5.500	17	1.460	with	LNMU03...	1
EXN03R112U0100-05	0.039	1.125	5	0.871	1.000	5.500	2.500	3.000	17	1.120	with	LNMU03...	1
EXN03R125U0125-05	0.039	1.250	5	0.997	1.250	6.000	3.000	3.000	17	1.870	with	LNMU03...	1
EXN03R125U0125-05L	0.039	1.250	5	0.997	1.250	8.000	5.000	3.000	17	2.430	with	LNMU03...	1
EXN03R125U0125-06	0.039	1.250	6	0.997	1.250	6.000	3.000	3.000	17	1.850	with	LNMU03...	1
EXN03R125U0125-06-C	0.039	1.250	6	1.008	1.250	6.000	3.000	3.000	17	1.760	with	LNMU03...	2

SPARE PARTS

Designation	Clamping screw	Lubricant	Wrench
EXN03...	CSPB-2.5	M-1000	IP-8D

Reference pages

Inserts → D009, Standard cutting conditions → D010 - D011

A.R. = +6°, R.R. = +5° ~ +11°

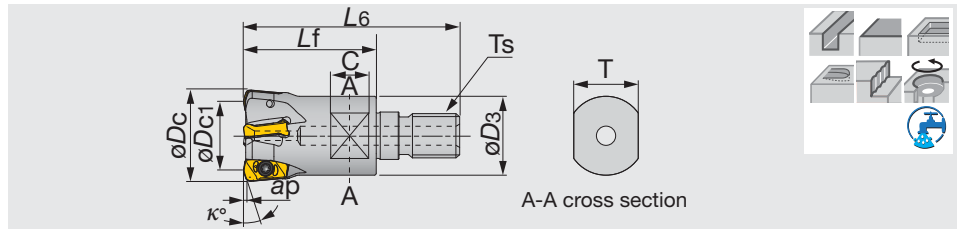

Metric	Max. ap	ϕD_c	z	ϕD_{c1}	L6	Lf	C	T	ϕD_3	κ°	Ts	Kg	Air hole	Insert
HXN03R016MM08-02	1	16	2	9.5	42	25	8	10	12.8	15	M8	0.03	with	LNMU03...
HXN03R018MM08-02	1	18	2	11.5	42	25	8	10	14.5	17	M8	0.04	with	LNMU03...
HXN03R020MM10-03	1	20	3	13.5	49	30	10	15	17.8	17	M10	0.06	with	LNMU03...
HXN03R020MM10-04	1	20	4	13.5	49	30	10	15	17.8	17	M10	0.06	with	LNMU03...
HXN03R022MM10-03	1	22	3	15.5	49	30	10	15	17.8	17	M10	0.06	with	LNMU03...
HXN03R022MM10-04	1	22	4	15.5	49	30	10	15	17.8	17	M10	0.07	with	LNMU03...
HXN03R025MM12-04	1	25	4	18.5	57	35	10	17	20.8	17	M12	0.1	with	LNMU03...
HXN03R025MM12-05	1	25	5	18.5	57	35	10	17	20.8	17	M12	0.11	with	LNMU03...
HXN03R028MM12-04	1	28	4	21.5	57	35	10	17	23	17	M12	0.12	with	LNMU03...
HXN03R028MM12-05	1	28	5	21.5	57	35	10	17	23	17	M12	0.12	with	LNMU03...
HXN03R030MM16-04	1	30	4	23.5	63	40	12	22	28.8	17	M16	0.19	with	LNMU03...
HXN03R030MM16-05	1	30	5	23.5	63	40	12	22	28.8	17	M16	0.2	with	LNMU03...
HXN03R032MM16-05	1	32	5	25.5	63	40	12	22	28.8	17	M16	0.2	with	LNMU03...
HXN03R032MM16-06	1	32	6	25.5	63	40	12	22	28.8	17	M16	0.21	with	LNMU03...

SPARE PARTS

Designation	Clamping screw	Lubricant	Wrench
HXN03...	CSPB-2.5	M-1000	IP-8D

INSERT

LNMU03-MJ (for general purpose)

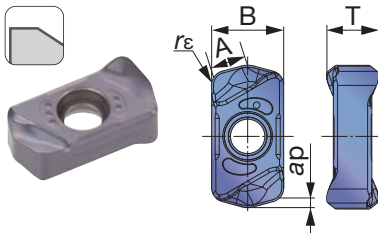

LNMU03-ML (for low cutting force)

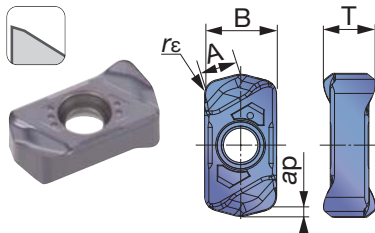

LNGU03-MH (for robust cutting edges)

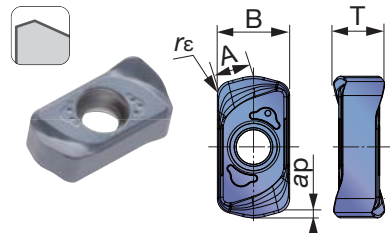

P	Steel	☆	★	☆															
M	Stainless	☆		★															
K	Cast iron		★		☆														
N	Non-ferrous																		
S	Superalloys	★	☆																
H	Hard materials		☆		★	★													

★ : First choice
☆ : Second choice

Designation	r_ϵ	Max. ap	Coated					A	B	T
			AH130	AH725	AH3035	AH8015	AH8005			
LNMU0303ZER-MJ	0.047	0.039	●	●	●	●	●	0.126	0.236	0.169
LNMU0303ZER-ML	0.047	0.039	●	●	●	●	●	0.126	0.236	0.169
LNGU0303ZER-MH	0.047	0.039				●	●	0.126	0.236	0.169

● : Line up

Reference pages

Standard cutting conditions → D010 - D011

STANDARD CUTTING CONDITIONS TXN03/EXN03/HXN03

ISO	Workpiece material	Hardness	Priority	Grade	Chip-breaker	Cutting speed Vc (sfm)	Feed per tooth: fz (ipt)									
							Tool dia.: ϕD_c (in)			$\phi 0.625"$, z=2		$\phi 0.688"$, z=2		$\phi 0.750"$		
							$\phi 0.620$ - $\phi 0.870$	$\phi 1.000$ - $\phi 2.000$	Plunging	n	Vf	n	Vf	n	Vf	
P	Carbon steels 1045, 1055, etc.	~ 300HB	First choice	AH3035	MJ	330 - 990	0.020 - 0.047	0.020 - 0.059	0.004	4,040	240	3,670	220	3,360	200	300
		~ 300HB	for wear resistance	AH8015	MJ	330 - 990	0.020 - 0.047	0.020 - 0.059	0.004	4,040	240	3,670	220	3,360	200	300
	Alloy steels 4140, SCr415, etc.	~ 300HB	First choice	AH3035	MJ	330 - 990	0.020 - 0.047	0.020 - 0.059	0.004	4,040	240	3,670	220	3,360	200	300
		~ 300HB	for wear resistance	AH8015	MJ	330 - 990	0.020 - 0.047	0.020 - 0.059	0.004	4,040	240	3,670	220	3,360	200	300
	Prehardened steels NAK80, PX5, etc.	30 ~ 40HRC	First choice	AH3035	ML	330 - 660	0.020 - 0.039	0.020 - 0.039	0.004	3,060	180	2,780	170	2,550	150	230
		30 ~ 40HRC	for impact resistance	AH3035	MJ	330 - 660	0.020 - 0.047	0.020 - 0.059	0.004	3,060	180	2,780	170	2,550	150	230
30 ~ 40HRC		for wear resistance	AH8015	ML	330 - 660	0.020 - 0.039	0.020 - 0.039	0.004	3,060	180	2,780	170	2,550	150	230	
M	Stainless steels 304, 316, etc.	~ 200HB	First choice	AH3035	ML	330 - 490	0.012 - 0.028	0.012 - 0.028	0.003	2,510	100	2,280	90	2,090	80	130
		~ 200HB	for impact resistance	AH3035	MJ	330 - 490	0.012 - 0.031	0.012 - 0.031	0.003	2,510	100	2,280	90	2,090	80	130
K	Gray cast irons No.250B, etc.	150 ~ 250HB	First choice	AH725	MJ	330 - 990	0.020 - 0.047	0.020 - 0.059	0.004	4,040	240	3,670	220	3,360	200	300
		150 ~ 250HB	for wear resistance	AH8015	MJ	330 - 990	0.020 - 0.047	0.020 - 0.059	0.004	4,040	240	3,670	220	3,360	200	300
	Ductile cast irons 65-45-12, etc.	150 ~ 250HB	First choice	AH725	MJ	260 - 660	0.020 - 0.047	0.020 - 0.059	0.004	3,610	220	3,280	200	3,010	180	270
		150 ~ 250HB	for wear resistance	AH8015	MJ	260 - 660	0.020 - 0.047	0.020 - 0.059	0.004	3,610	220	3,280	200	3,010	180	270
S	Titanium alloys Ti-6Al-4V, etc.	~ 40HRC	First choice	AH130	ML	100 - 200	0.012 - 0.028	0.012 - 0.028	0.003	920	37	830	33	760	30	46
		~ 40HRC	for impact resistance	AH130	MJ	100 - 200	0.012 - 0.028	0.012 - 0.028	0.003	920	37	830	33	760	30	46
	Heat-resistant alloys Inconel, Hastelloy, etc.	~ 40HRC	First choice	AH725	ML	70 - 170	0.004 - 0.012	0.004 - 0.012	0.002	730	12	670	11	610	10	15
		~ 40HRC	for wear resistance	AH8015	ML	70 - 170	0.004 - 0.012	0.004 - 0.012	0.002	730	12	670	11	610	10	15
H	Hot mold steel HB, etc.	40 ~ 50HRC	First choice	AH8015	MJ	260 - 490	0.004 - 0.020	0.004 - 0.020	0.002	2,320	56	2,110	51	1,940	47	70
		50 ~ 60HRC	for impact resistance	AH3035	MJ	260 - 490	0.004 - 0.012	0.004 - 0.012	0.002	2,320	37	2,110	34	1,940	31	47
	Cold mold steel D2, etc.	50 ~ 60HRC	First choice	AH8015	MJ	160 - 230	0.002 - 0.008	0.002 - 0.008	0.001	1,220	12	1,110	11	1,020	10	15
		50 ~ 60HRC	for impact resistance	AH725	MJ	160 - 230	0.001 - 0.002	0.001 - 0.003	0.001	1,220	4	1,110	3	1,020	3	5

When chips stay in the cutting zone during slotting or pocketing, use air blast to remove chips from the work area.

Tool overhang length must be as short as possible to avoid chatter. When the tool overhang length is long, decrease the number of revolutions and feed.

CAUTIONARY POINTS IN USE

The use of a standard or long shank

When using a long shank, please lower the cutting conditions (Vc, fz, ap) to 70% of the maximum conditions for the standard shank.

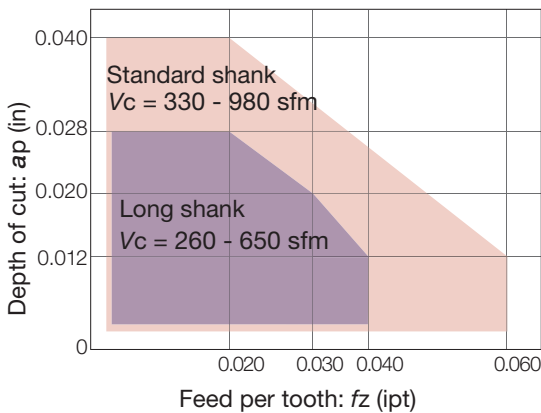

Tool dia.: $\phi D_c = \phi 0.625 - 1.250"$ **L/D ratio of overhang**
 Workpiece material: 1055 (200HB) Standard shank: L/D \leq 3
 Long shank: L/D = 4

Tool geometry for programming

When programming for CAM, the tool should be considered as a radius cutters. Usually, the corner radius should be set as R = 0.060". If a larger radius is used, overcutting will occur. The following table shows the amount left as uncut (t1) and overcut (t2).

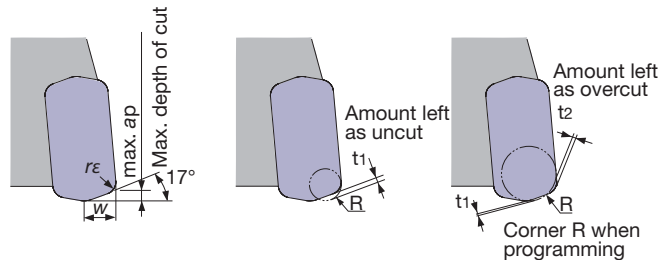

Max. depth of cut max. ap	Corner radius r ϵ	W (in)	Corner R when programming	Amount left as uncut t1	Amount left as overcut t2
0.039	0.047	0.118	0.039	0.024	-
			0.060	0.020	-
			0.079	0.010	0.003
			0.098	0.006	0.010

Each value in table is calculated theoretically at the maximum condition.

Tool dia.: ϕD_c (in), Number of revolutions: n (rpm⁻¹), Feed speed: V_f (ipm), Max. depth of cut: $a_p = 0.039"$, No. of teeth: z

$\phi 0.875"$			$\phi 1.000"$			$\phi 1.125"$			$\phi 1.250"$			$\phi 1.500"$			$\phi 2.000"$		
n	V_f		n	V_f		n	V_f		n	V_f		n	V_f		n	V_f	
	Z=2	Z=3		Z=4	Z=5		Z=4	Z=5		Z=5	Z=6		Z=5	Z=6		Z=5	Z=6
2,970	180	270	2,520	400	500	2,240	360	450	2,020	400	480	1,680	340	400	1,260	250	400
$V_c = 660 \text{ sfm}, f_z = 0.04 \text{ ipt}$																	
2,970	180	270	2,520	400	500	2,240	360	450	2,020	400	480	1,680	340	400	1,260	250	400
$V_c = 660 \text{ sfm}, f_z = 0.04 \text{ ipt}$																	
2,970	180	270	2,520	400	500	2,240	360	450	2,020	400	480	1,680	340	400	1,260	250	400
$V_c = 660 \text{ sfm}, f_z = 0.04 \text{ ipt}$																	
2,970	180	270	2,520	400	500	2,240	360	450	2,020	400	480	1,680	340	400	1,260	250	400
$V_c = 500 \text{ sfm}, f_z = 0.03 \text{ ipt}$																	
2,250	140	200	1,910	230	290	1,700	200	260	1,530	230	280	1,270	190	230	960	140	230
$V_c = 500 \text{ sfm}, f_z = 0.03 \text{ ipt}$																	
2,250	140	200	1,910	310	380	1,700	270	340	1,530	310	370	1,270	250	300	960	190	310
$V_c = 500 \text{ sfm}, f_z = 0.04 \text{ ipt}$																	
2,250	140	200	1,910	230	290	1,700	200	260	1,530	230	280	1,270	190	230	960	140	230
$V_c = 500 \text{ sfm}, f_z = 0.03 \text{ ipt}$																	
1,840	70	110	1,570	130	160	1,390	110	140	1,250	130	150	1,040	100	120	780	80	120
$V_c = 410 \text{ sfm}, f_z = 0.02 \text{ ipt}$																	
1,840	70	110	1,570	130	160	1,390	110	140	1,250	130	150	1,040	100	120	780	80	120
$V_c = 410 \text{ sfm}, f_z = 0.02 \text{ ipt}$																	
2,970	180	270	2,520	400	500	2,240	360	450	2,020	400	480	1,680	340	400	1,260	250	400
$V_c = 660 \text{ sfm}, f_z = 0.04 \text{ ipt}$																	
2,970	180	270	2,520	400	500	2,240	360	450	2,020	400	480	1,680	340	400	1,260	250	400
$V_c = 660 \text{ sfm}, f_z = 0.04 \text{ ipt}$																	
2,650	160	240	2,250	360	450	2,000	320	400	1,800	360	430	1,500	300	360	1,130	230	360
$V_c = 590 \text{ sfm}, f_z = 0.04 \text{ ipt}$																	
2,650	160	240	2,250	360	450	2,000	320	400	1,800	360	430	1,500	300	360	1,130	230	360
$V_c = 590 \text{ sfm}, f_z = 0.04 \text{ ipt}$																	
670	27	40	570	46	57	510	41	51	460	46	55	380	38	46	290	29	46
$V_c = 150 \text{ sfm}, f_z = 0.02 \text{ ipt}$																	
670	27	40	570	46	57	510	41	51	460	46	55	380	38	46	290	29	46
$V_c = 150 \text{ sfm}, f_z = 0.02 \text{ ipt}$																	
540	9	13	460	15	18	410	13	16	370	15	18	310	12	15	230	9	15
$V_c = 120 \text{ sfm}, f_z = 0.008 \text{ ipt}$																	
540	9	13	460	15	18	410	13	16	370	15	18	310	12	15	230	9	15
$V_c = 120 \text{ sfm}, f_z = 0.008 \text{ ipt}$																	
1,710	41	62	1,450	70	87	1,290	62	77	1,160	70	84	970	58	70	730	44	70
$V_c = 380 \text{ sfm}, f_z = 0.012 \text{ ipt}$																	
1,710	27	41	1,450	46	58	1,290	41	52	1,160	46	56	970	39	47	730	29	47
$V_c = 380 \text{ sfm}, f_z = 0.008 \text{ ipt}$																	
900	9	14	760	15	19	680	14	17	610	15	18	510	13	15	380	10	15
$V_c = 200 \text{ sfm}, f_z = 0.005 \text{ ipt}$																	
900	3	4	760	6	8	680	5	7	610	6	7	510	5	6	380	4	6
$V_c = 200 \text{ sfm}, f_z = 0.002 \text{ ipt}$																	

The above table shows the conditions for standard shank type cutters. When using long shank type cutters, the number of teeth may be different. In this case, the cutting conditions should be changed by referring to: "The use of standard or long shanks" shown in previous page.

Cutting conditions are generally limited by the rigidity and power of the machine and the rigidity of the workpiece. When setting the conditions, start from half of the values of the standard cutting conditions and then increase the value gradually while making sure the machine is running normally.

APPLICATION RANGE

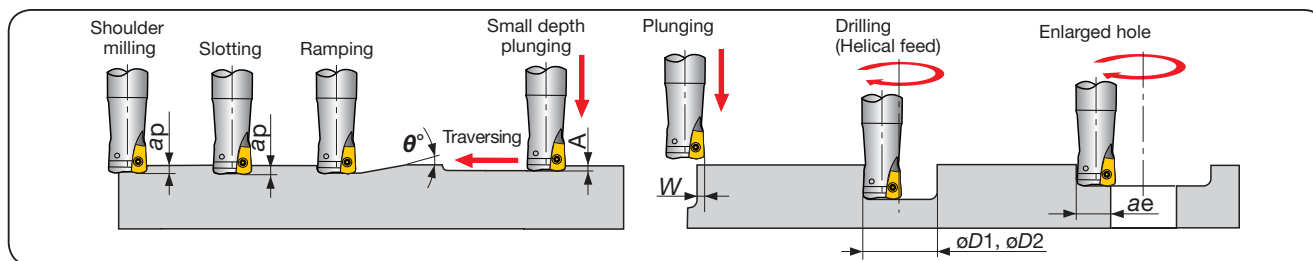

Inch	Tool dia. ϕD_c	Max. depth of cut Max a_p	Max. ramping angle θ°	Max. plunging depth A	Max. cutting width in plunging W	Min. machinable hole dia. $\phi D1$	Max. machinable hole dia. $\phi D2$	Max. cutting width in enlarged hole ae
EXN03R062U0062...	0.625	0.039	2.1	0.012	0.138	0.866	1.181	0.492
EXN03R068U0062...	0.688	0.039	1.7	0.012	0.138	1.024	1.339	0.571
EXN03R075U0075...	0.750	0.039	1.4	0.012	0.138	1.181	1.496	0.650
EXN03R087U0075...	0.875	0.039	1.2	0.012	0.138	1.339	1.654	0.728
EXN03R100U0100...	1.000	0.039	1.0	0.012	0.138	1.575	1.890	0.846
EXN03R112U0100...	1.125	0.039	0.8	0.012	0.138	1.811	2.126	0.965
EXN03R125U0125...	1.250	0.039	0.7	0.012	0.138	2.126	2.441	1.122
TXN03R150U0075...	1.500	0.039	0.5	0.012	0.138	2.750	3.070	1.437
TXN03R200U0075...	2.000	0.039	0.4	0.012	0.138	3.540	3.858	1.830

For ϕD_c above 1.300", slot milling, ramping or contouring is not recommended as chips may be re-cut.



DOFEED

TXN06

Super high feed milling cutters with double sided inserts with 4 edges

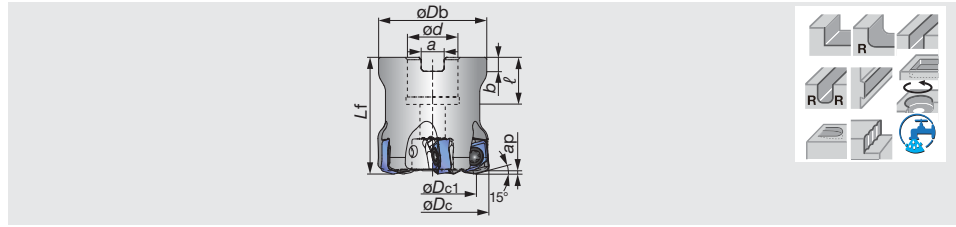

Inch	Max. ap	ϕD_c	z	ϕD_{c1}	ϕD_b	L_f	ϕd	ℓ	a	b	lb	Air hole	Insert
TXN06R200U0075A04	0.059	2.000	4	1.513	1.850	1.969	0.750	0.750	0.315	0.197	0.970	with	LN*U06...
TXN06R200U0075A05	0.059	2.000	5	1.513	1.850	1.969	0.750	0.750	0.315	0.197	0.990	with	LN*U06...
TXN06R250U0075A04	0.059	2.500	4	2.012	2.323	1.969	0.750	0.750	0.315	0.197	1.740	with	LN*U06...
TXN06R250U0075A06	0.059	2.500	6	2.012	2.323	1.969	0.750	0.750	0.315	0.197	1.760	with	LN*U06...
TXN06R300U0100A05	0.059	3.000	5	2.512	2.835	2.480	1.000	1.049	0.374	0.236	3.130	with	LN*U06...
TXN06R300U0100A07	0.059	3.000	7	2.512	2.835	2.480	1.000	1.049	0.374	0.236	3.280	with	LN*U06...
TXN06R400U0150A06	0.059	4.000	6	3.512	3.819	2.480	1.500	1.610	0.626	0.394	4.850	with	LN*U06...
TXN06R400U0150A10	0.059	4.000	10	3.512	3.819	2.480	1.500	1.610	0.626	0.394	4.850	with	LN*U06...
TXN06R500U0150A08	0.059	5.000	8	4.512	3.819	2.480	1.500	1.610	0.626	0.394	7.050	with	LN*U06...
TXN06R500U0150A12	0.059	5.000	12	4.512	3.819	2.480	1.500	1.610	0.626	0.394	7.280	with	LN*U06...
TXN06R600U0200A10	0.059	6.000	10	5.512	4.331	2.480	2.000	1.496	0.748	0.433	9.480	with	LN*U06...
TXN06R600U0200A14	0.059	6.000	14	5.512	4.331	2.480	2.000	1.496	0.748	0.433	9.260	with	LN*U06...

SPARE PARTS



Designation	Clamping screw	Grip	Lubricant	Torx bit	Center bolt (Optional parts)
TXN06R200U - 500U	CSPB-5	H-TB2W	M-1000	BLDIP20/S7	(C0.375X1.125H)
TXN06R600U...	CSPB-5	H-TB2W	M-1000	BLDIP20/M7	(TMBA-0.750H)

Reference pages

Inserts → **D013**, Standard cutting conditions → **D014 - D015**

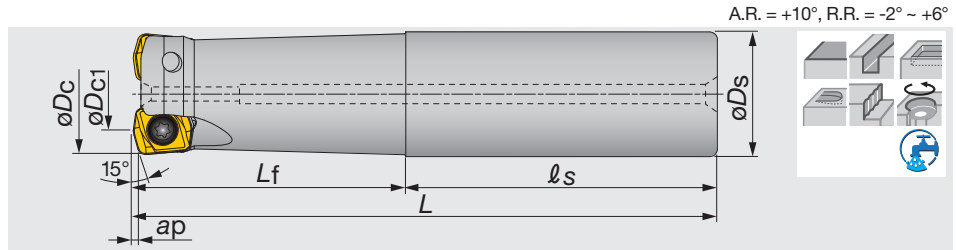

Inch	Max. ap	ϕDc	z	$\phi Dc1$	ϕDs	L	L_f	l_s	lb	Air hole	Insert
EXN06R125U0125W02	0.059	1.250	2	0.766	1.250	5.281	3.000	2.281	1.540	with	LN*U06...
EXN06R125U0125-02L	0.059	1.250	2	0.766	1.250	8.000	5.000	3.000	2.360	with	LN*U06...
EXN06R150U0125W03	0.059	1.500	3	1.014	1.250	5.781	3.500	2.281	1.830	with	LN*U06...
EXN06R150U0125-03L	0.059	1.500	3	1.014	1.250	10.000	2.000	8.000	3.310	with	LN*U06...

SPARE PARTS

Designation	Clamping screw	Lubricant	Wrench
EXN06...	CSPB-5	M-1000	IP-20D

INSERT

LNMU06-MJ

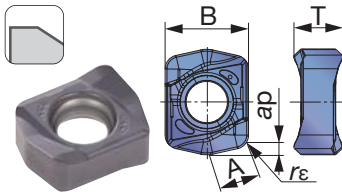

LNMU06-ML

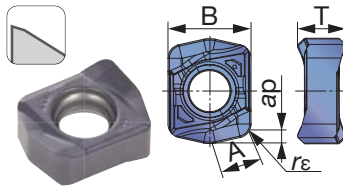

LNGU06-MH

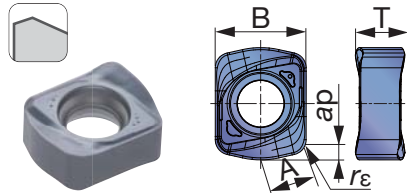

LNGU06-W (2 cutting edges)

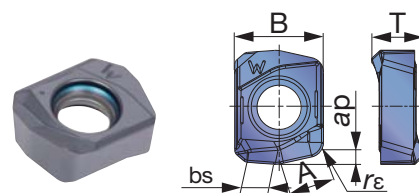

P Steel		☆	★	☆	
M Stainless		☆	★		
K Cast iron	★	☆	☆		
N Non-ferrous					
S Superalloys	★	☆			
H Hard materials		☆	★	★	

★ : First choice
☆ : Second choice

Designation	r_ϵ	Max. ap	Coated						A	B	T	bs
			AH120	AH130	AH725	AH3035	AH8015	AH8005				
LNMU06X5ZER-MJ	0.079	0.059	●	●	●	●	●	●	0.236	0.472	0.276	-
LNMU06X5ZER-ML	0.079	0.059	●	●	●	●	●	●	0.236	0.472	0.276	-
LNGU06X5ZER-MH	0.079	0.059					●	●	0.236	0.472	0.276	-
LNGU06X5ZER-W	0.079	0.059			●				0.236	0.472	0.276	0.142

● : Line up

Reference pages

Standard cutting conditions → D014 - D015

STANDARD CUTTING CONDITIONS TXN06 / EXN06

ISO	Work material	Hardness	Priority	Grades	Chip-breaker	Cutting speed Vc (sfm)	Feed per tooth fz (ipt)		Feed per tooth fz (ipt)							
							Tool dia: øDc (in)	Feed when plunging fz (ipt)	ø1.250", z = 2		ø1.500", z = 2		ø2.000"			
									n	Vf	n	Vf	n	Vf		
P	Carbon steels 1045, 1055, etc.	~ 300HB	First choice for wear resistance	AH3035 AH8015	MJ MJ	330 - 990	0.020 - 0.059	0.006	2,020	162	1,680	134	1,261	202	252	
	Alloy steels 4140, SCr415, etc.	~ 300HB	First choice for wear resistance	AH3035 AH8015	MJ MJ	330 - 990	0.020 - 0.059	0.006	2,018	161	1,682	135	1,261	202	252	
	Prehardened steels NAK80, PX5, etc.	30 ~ 40HRC	First choice	for impact resistance	AH3035	ML MJ	330 - 660	0.020 - 0.039	0.006	1,529	92	1,274	76	955	115	143
		30 ~ 40HRC	for wear resistance		AH8015	ML	330 - 660	0.020 - 0.039	0.006	1,529	92	1,274	76	955	115	143
M	Stainless steels 304, 316, etc.	~ 200HB	First choice	AH3035	ML	330 - 490	0.012 - 0.028	0.004	1,254	50	1,045	42	783	63	78	
		~ 200HB	for impact resistance	AH3035	MJ	330 - 490	0.012 - 0.031	0.004	1,254	50	1,045	42	783	63	78	
K	Gray cast irons No.250B, etc.	150 ~ 250HB	First choice	AH120	MJ	330 - 990	0.020 - 0.059	0.006	2,018	161	1,682	135	1,261	202	252	
		150 ~ 250HB	for wear resistance	AH8015	MJ	330 - 990	0.020 - 0.059	0.006	2,018	161	1,682	135	1,261	202	252	
	Ductile cast irons 65-45-12, etc.	150 ~ 250HB	First choice	AH120	MJ	260 - 660	0.020 - 0.059	0.006	1,406	113	1,172	94	879	141	176	
		150 ~ 250HB	for wear resistance	AH8015	MJ	260 - 660	0.020 - 0.059	0.006	1,406	113	1,172	94	879	141	176	
S	Titanium alloys Ti-6Al-4V, etc.	~ 40HRC	First choice for impact resistance	AH130 AH130	ML MJ	100 - 200	0.012 - 0.028	0.003	459	18	382	15	287	23	29	
	Heat-resistant alloys Inconel, Hastelloy, etc.	~ 40HRC	First choice for wear resistance	AH725 AH8015	ML ML	70 - 170	0.004 - 0.012	0.002	367	6	306	5	229	7	9	
H	Hot mold steel HB, etc.	40 ~ 50HRC	First choice	AH8015	MJ	260 - 490	0.004 - 0.020	0.002	1,162	28	968	23	726	35	44	
		40 ~ 50HRC	for impact resistance	AH3035	MJ	260 - 490	0.004 - 0.012	0.002	1,162	19	968	15	726	23	29	
	Cold mold steel D2, etc.	50 ~ 60HRC	First choice	AH8015	MJ	160 - 230	0.002 - 0.008	0.001	611	6	510	5	382	8	10	
		50 ~ 60HRC	for impact resistance	AH725	MJ	160 - 230	0.001 - 0.003	0.001	611	2	510	2	382	3	4	

When chips stay in the cutting zone during slotting or pocketing, use air blast to remove chips from the work area.

Tool overhang length must be as short as possible to avoid chatter. When the tool overhang length is long, decrease the number of revolutions and feed.

CAUTIONARY POINTS IN USE

The usage of a standard & long shank

When using a long shank, please lower the cutting conditions (Vc, fz, ap) to 70% of the maximum conditions for the standard shank.

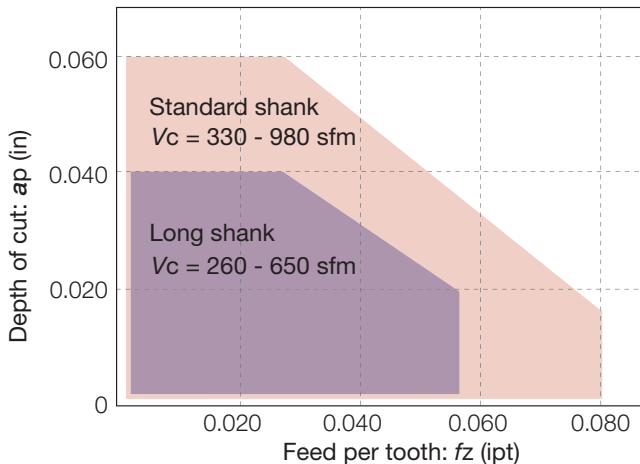

Tool dia.: øDc = ø1.250" - 1.500" **L/D ratio of overhang**
 Workpiece material: 1055 (200HB) Standard shank: L/D ≤ 3
 Long shank: L/D = 4

Tool geometry for programming

When programming for CAM, the tool should be considered as a radius cutters. Usually, the corner radius should be set as R = 0.118". If a larger radius is used, overcutting will occur. The following table shows the amount left as uncut (t1) and overcut (t2).

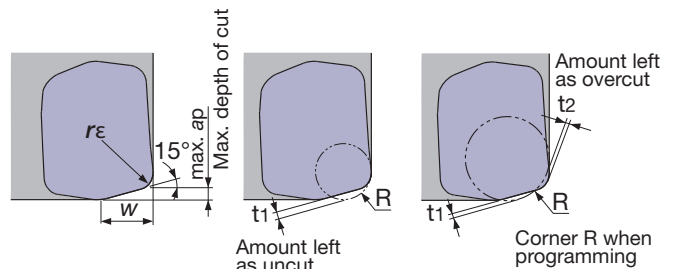

Max. depth of cut max. ap (in)	Corner radius Rε	W (in)	Corner R when programming	Amount left as uncut t1	Amount left as overcut t2
0.059	0.079	0.236	0.079	0.040	-
			0.118	0.030	-
			0.157	0.021	0.010

Each value in table is calculated theoretically at the maximum condition.

Tool dia: ϕD_c (in), Number of revolution: n (rpm), Feed speed: V_f (ipm),
Max. depth of cut: $ap = 0.059"$, Number of teeth: z

$\phi 2.500"$			$\phi 3.000"$			$\phi 4.000"$			$\phi 5.000"$			$\phi 6.000"$		
n	V_f		n	V_f		n	V_f		n	V_f		n	V_f	
	$z=4$	$z=6$		$z=5$	$z=7$		$z=6$	$z=10$		$z=8$	$z=12$		$z=10$	$z=15$
1,009	161	202	841	168	235	631	151	252	504	161	242	420	168	252
$V_c = 660$ sfm, $f_z = 0.040$ ipt														
1,009	161	202	841	168	235	631	151	252	504	161	242	420	168	252
$V_c = 660$ sfm, $f_z = 0.040$ ipt														
1,009	161	202	841	168	235	631	151	252	504	161	242	420	168	252
$V_c = 500$ sfm, $f_z = 0.030$ ipt														
764	122	153	637	127	178	478	115	191	382	122	183	318	127	191
$V_c = 500$ sfm, $f_z = 0.040$ ipt														
764	92	115	637	96	134	478	86	143	382	92	138	318	96	143
$V_c = 500$ sfm, $f_z = 0.030$ ipt														
627	50	63	522	52	73	392	47	78	313	50	75	261	52	78
$V_c = 410$ sfm, $f_z = 0.020$ ipt														
627	50	63	522	52	73	392	47	78	313	50	75	261	52	78
$V_c = 410$ sfm, $f_z = 0.020$ ipt														
1,009	161	202	841	168	235	631	151	252	504	161	242	420	168	252
$V_c = 660$ sfm, $f_z = 0.040$ ipt														
1,009	161	202	841	168	235	631	151	252	504	161	242	420	168	252
$V_c = 660$ sfm, $f_z = 0.040$ ipt														
703	113	141	586	117	164	439	105	176	352	113	169	293	117	176
$V_c = 460$ sfm, $f_z = 0.040$ ipt														
703	113	141	586	117	164	439	105	176	352	113	169	293	117	176
$V_c = 460$ sfm, $f_z = 0.040$ ipt														
229	18	23	191	19	27	143	17	29	115	18	28	96	19	29
$V_c = 150$ sfm, $f_z = 0.020$ ipt														
183	6	7	153	6	9	115	6	9	92	6	9	76	6	9
$V_c = 120$ sfm, $f_z = 0.008$ ipt														
581	28	35	484	29	41	363	26	44	290	28	42	242	29	44
$V_c = 380$ sfm, $f_z = 0.012$ ipt														
581	19	23	484	19	27	363	17	29	290	19	28	242	19	29
$V_c = 380$ sfm, $f_z = 0.012$ ipt														
306	6	8	255	6	9	191	6	10	153	6	9	127	6	10
$V_c = 200$ sfm, $f_z = 0.005$ ipt														
306	2	3	255	3	4	191	2	4	153	2	4	127	3	4
$V_c = 200$ sfm, $f_z = 0.005$ ipt														

The above table shows the conditions for standard shank type cutters. When using long shank type cutters, the number of teeth may be different. In this case, the cutting conditions should be changed by referring to: "The usage of standard and long shanks" shown in previous page.

Cutting conditions are generally limited by the rigidity and power of the machine and the rigidity of the workpiece. When setting the conditions, start from half of the values of the standard cutting conditions and then increase the value gradually while making sure the machine is running normally.

APPLICATION RANGE

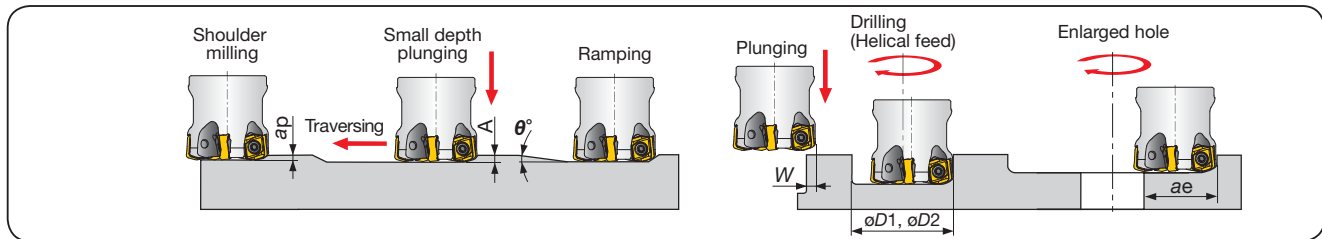

Inch	Tool dia. ϕD_c	Max. depth of cut Max. ap	Max. ramping angle θ°	Max. plunging depth A	Max. cutting width in plunging W	Min. machinable hole dia. $\phi D1$	Max. machinable hole dia. $\phi D2$	Max. cutting width in enlarged hole ae
EXN06R125U...	$\phi 1.250$	0.059	2.0°	0.020	0.236	1.830	2.300	0.970
EXN06R150U...	$\phi 1.500$	0.059	1.5°	0.020	0.236	2.330	2.800	1.220
TXN06R200U...	$\phi 2.000$	0.059	0.9°	0.020	0.236	3.330	3.800	1.720
TXN06R250U...	$\phi 2.500$	0.059	0.6°	0.020	0.236	4.330	4.800	2.220
TXN06R300U...	$\phi 3.000$	0.059	0.5°	0.020	0.236	5.330	5.800	2.720

· For ϕD_c above 4.000", slot milling, ramping or contouring is not recommended as chips may be re-cut.

Radius cutter with double-sided insert with 4 edges

A.R. = +3°, R.R. = -13°

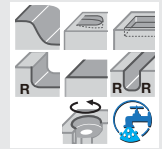
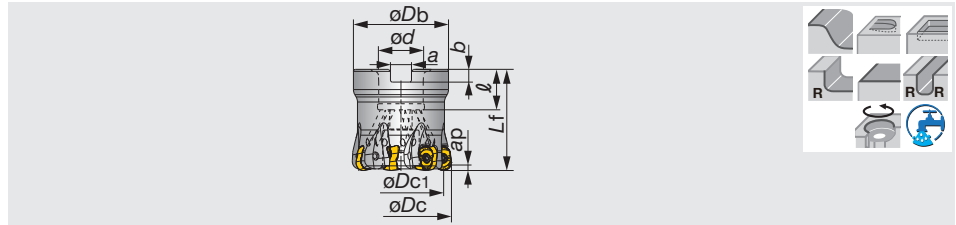

Inch	Max. ap	ϕDc	z	$\phi Dc1$	ϕDb	L_f	ϕd	ℓ	a	b	lb	Air hole	Insert
TXLN04U1.50B0.50R06	0.157	1.500	6	1.177	1.375	1.574	0.500	0.610	0.258	0.157	0.770	with	LNMX04...
TXLN04U2.00B0.75R07	0.157	2.000	7	1.677	1.845	1.969	0.750	0.750	0.315	0.197	0.990	with	LNMX04...

SPARE PARTS



Designation	Clamping screw	Grip	Lubricant	Torx bit	Center bolt (Optional parts)
TXLN04U1.50B0.50R06	CSPD-3	SW6-SD	M-1000	BLD IP10/S7	(SR UNF 1/4X3/4 B18.3)
TXLN04U2.00B0.75R07	CSPD-3	SW6-SD	M-1000	BLD IP10/S7	(C0.375X1.125H)

Radius cutter with double-sided insert with 4 edges

A.R. = +3°, R.R. = -12° ~ -14°

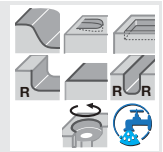
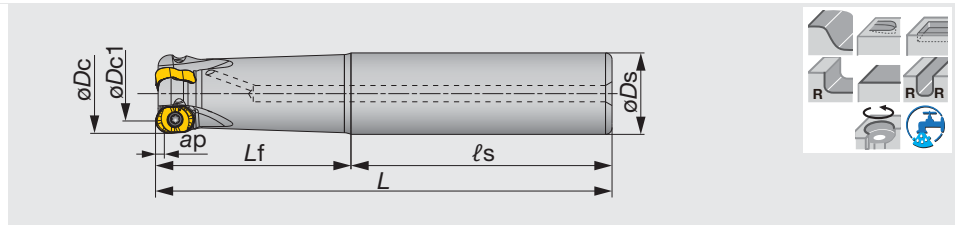

Inch	Max. ap	ϕDc	z	$\phi Dc1$	ϕDs	ℓ_s	L_f	L	lb	Air hole	Insert
EXLN04U1.00C1.00R03	0.157	1.000	3	0.685	1.000	3.000	2.500	5.500	1.000	with	LNMX04...
EXLN04U1.25C1.25R04	0.157	1.250	4	0.935	1.250	3.000	3.000	6.000	1.800	with	LNMX04...
EXLN04U1.25C1.25R05	0.157	1.250	5	0.935	1.250	3.000	3.000	6.000	1.800	with	LNMX04...

SPARE PARTS



Designation	Clamping screw	Mono block type wrench
EXLN04U...	CSPD-3	IP-10D

Reference pages

Inserts → **D017**, Standard cutting conditions → **D018**

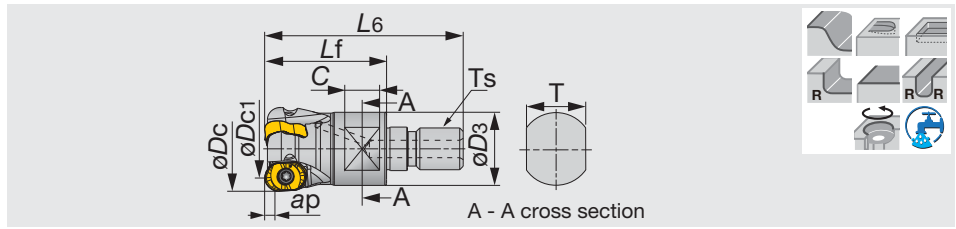

A.R. = +3°, R.R. = -12° ~ -14°

Metric	Max. ap	øDc	z	øDc1	L6	Lf	C	T	øD3	Ts	Kg	Air hole	Insert
HXLN04M020M10R02	4	20	2	12	49	30	10	15	18	M10	0.07	with	LNMX04...
HXLN04M025M12R03	4	25	3	17	57	35	10	17	21	M12	0.16	with	LNMX04...
HXLN04M032M16R04	4	32	4	24	63	40	12	22	29	M16	0.2	with	LNMX04...

SPARE PARTS

Designation	Clamping screw	Lubricant	Wrench
HXLN04...	CSPD-3	M-1000	IP-10D

INSERT

LNMX-MJ

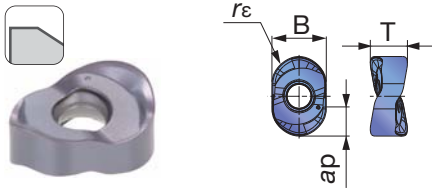

LNMX-ML

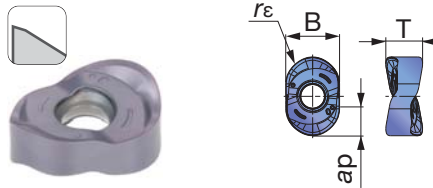

LNMX-HJ

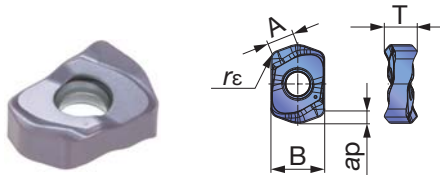

P Steel	☆	★								
M Stainless		★								
K Cast iron	★									
N Non-ferrous										
S Superalloys	★	☆								
H Hard materials	★	★								

★ : First choice
☆ : Second choice

Designation	rε	Max. ap	Coated								A	B	T
			AH120	AH3135									
LNMX0405R4-MJ	0.157	0.157	●	●							-	0.323	0.220
LNMX0405R4-ML	0.157	0.157	●	●							-	0.323	0.220
LNMX0405ZER-HJ	0.051	0.051	●	●							0.169	0.323	0.197

● : Line up

Reference pages

Standard cutting conditions → **D018**

STANDARD CUTTING CONDITIONS

For MJ, ML type (Radius insert)

ISO	Workpiece material	Hardness	Priority	Grade	Chip-breaker	Cutting speed Vc (sfm)	Feed per tooth fz (ipt)	
P	Low carbon steels 1015, etc.	- 300 HB	First choice	AH3135	MJ	490 - 820	0.0079 - 0.0236	
		- 300 HB	Second choice	AH3135	ML	490 - 820	0.0079 - 0.0236	
	Carbon steels, Alloy steels 1055, etc.	- 300 HB	First choice	AH3135	MJ	490 - 820	0.0079 - 0.0236	
		- 300 HB	Second choice	AH3135	ML	490 - 820	0.0079 - 0.0236	
	Prehardened steels NAK80, PX5, etc.	30 - 40 HRC	First choice	AH3135	MJ	330 - 660	0.0059 - 0.0157	
		30 - 40 HRC	Second choice	AH3135	ML	330 - 660	0.0059 - 0.0157	
M	Stainless steels S30400, etc	- 200 HB	First choice	AH3135	MJ	330 - 660	0.0079 - 0.0236	
		- 200 HB	Second choice	AH3135	ML	330 - 660	0.0079 - 0.0236	
	Stainless steels S4200, etc	- 200 HB	First choice	AH3135	MJ	330 - 980	0.0079 - 0.0236	
		- 200 HB	Second choice	AH3135	ML	330 - 980	0.0079 - 0.0236	
K	Grey cast irons No.250B, No.300B, etc.	150 - 250 HB	First choice	AH120	MJ	490 - 820	0.0079 - 0.0236	
		150 - 250 HB	Second choice	AH120	ML	490 - 820	0.0079 - 0.0236	
	Ductile cast irons 60-40-18, 80-50-06, etc.	150 - 250 HB	First choice	AH120	MJ	490 - 820	0.0079 - 0.0236	
		150 - 250 HB	Second choice	AH120	ML	490 - 820	0.0079 - 0.0236	
S	Titanium alloys Ti-6Al-4V, etc.	- 40 HRC	First choice	AH3135	ML	98 - 197	0.0039 - 0.0118	
	Heat-resistant alloys Inconel 718, etc.	- 40 HRC	First choice	AH120	MJ	33 - 131	0.0039 - 0.0079	
H	Hardened steel	H13, etc	40 - 50 HRC	First choice	AH3135	MJ	160 - 490	0.0039 - 0.0118
			40 - 50 HRC	Second choice	AH3135	ML	160 - 490	0.0039 - 0.0118
	D2, etc	50 - 60 HRC	First choice	AH120	MJ	160 - 230	0.0020 - 0.0059	
		50 - 60 HRC	Second choice	AH120	ML	160 - 230	0.0020 - 0.0059	

For HJ type (High feed insert)

ISO	Workpiece material	Hardness	Priority	Grade	Chipbreaker	Cutting speed Vc (sfm)	Feed per tooth fz (ipt)	
P	Low carbon steels C15, C20, etc.	- 300 HB	First choice	AH3135	HJ	490 - 820	0.0197 - 0.059	
			Second choice	AH120	HJ	490 - 820	0.0197 - 0.059	
	Carbon steels, Alloy steels 1055, etc.	- 300 HB	First choice	AH3135	HJ	490 - 820	0.0197 - 0.059	
			Second choice	AH120	HJ	490 - 820	0.0197 - 0.059	
	Carbon steels, Alloy steels 1055, etc.	30 - 40 HRC	First choice	AH3135	HJ	330 - 660	0.0118 - 0.0276	
			Second choice	AH120	HJ	330 - 660	0.0118 - 0.0276	
M	Stainless steels S30400, etc	- 200 HB	First choice	AH3135	HJ	330 - 660	0.0118 - 0.0276	
		- 200 HB	First choice	AH3135	HJ	330 - 980	0.0118 - 0.0276	
K	Grey cast irons No.250B, No.300B, etc.	150 - 250 HB	First choice	AH120	HJ	490 - 820	0.0197 - 0.059	
	Ductile cast irons 60-40-18, 80-50-06, etc.	150 - 250 HB	First choice	AH120	HJ	490 - 820	0.0197 - 0.059	
S	Titanium alloys Ti-6Al-4V, etc.	- 40 HRC	First choice	AH3135	HJ	98 - 197	0.0118 - 0.028	
	Heat-resistant alloys Inconel 718, etc.	- 40 HRC	First choice	AH120	HJ	33 - 131	0.0039 - 0.0118	
H	Hardened steel	H13, etc	40 - 50 HRC	First choice	AH3135	HJ	160 - 490	0.0039 - 0.0197
			40 - 50 HRC	Second choice	AH120	HJ	160 - 490	0.0039 - 0.0197
	D2, etc	50 - 60 HRC	First choice	AH120	HJ	160 - 230	0.0020 - 0.0079	

Note: Recommended cutting conditions are just for reference in general machining.

APPLICATION RANGE

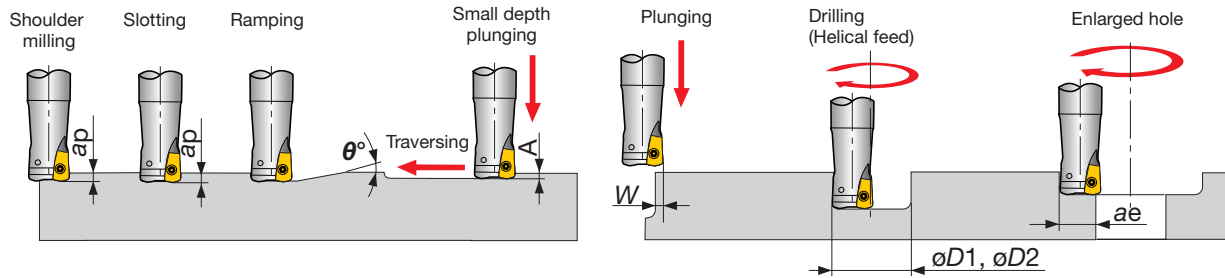

For MJ, ML type

	Tool dia.	Max. depth of cut (in)	Max. ramping angle	Max. plunging (in)	Max. cutting width in plunging (in)	Min. machining (in)	Max. machining (in)	Max. cutting width in enlarging (in)
Inch	ϕDc	ap	θ°	A	W	$\phi D1$	$\phi D2$	ae
EXLN04U1.00C1.00R03	1.000	0.157	3	0.031	0.157	1.535	1.929	0.803
EXLN04U1.25C1.25R04	1.250	0.157	1.9	0.031	0.157	2.047	2.402	1.053
EXLN04U1.25C1.25R05	1.250	0.157	1.9	0.031	0.157	2.047	2.402	1.053
TXLN04U1.50B0.50R06	1.500	0.157	1.2	0.024	0.157	2.511	2.905	1.342
TXLN04U2.00B0.75R07	2.000	0.157	1	0.027	0.157	3.496	3.889	1.842

	Tool dia.	Max. depth of cut	Max. ramping angle	Max. plunging depth	Max. cutting width in plunging	Min. machining	Max. machining	Max. cutting width in enlarging	
Metric	ϕDc	$\phi Dc1$	ap	θ°	A	W	$\phi D1$	$\phi D2$	ae
HXLN04M020M10R02	20	12	4	4.7	0.8	4	28	38	15
HXLN04M025M12R03	25	17	4	3	0.8	4	38	48	20
HXLN04M032M16R04	32	24	4	2	0.8	4	50	62	27

For HJ type

	Tool dia.	Max. depth of cut (in)	Max. ramping angle	Max. plunging (in)	Max. cutting width in plunging (in)	Min. machining (in)	Max. machining (in)	Max. cutting width in enlarging (in)
Inch	ϕDc	ap	θ°	A	W	$\phi D1$	$\phi D2$	ae
EXLN04U1.00C1.00R03	1.000	0.051	3	0.030	0.161	1.496	1.929	0.803
EXLN04U1.25C1.25R04	1.250	0.051	2	0.030	0.161	2.008	2.441	1.053
EXLN04U1.25C1.25R05	1.250	0.051	2	0.030	0.161	2.008	2.441	1.053
TXLN04U1.50B0.50R06	1.500	0.157	1.2	0.024	0.157	2.456	2.905	1.342
TXLN04U2.00B0.75R07	2.000	0.157	1	0.027	0.157	3.456	3.889	1.842

	Tool dia.	Max. depth of cut	Max. ramping angle	Max. plunging depth	Max. cutting width in plunging	Min. machining	Max. machining	Max. cutting width in enlarging	
Metric	ϕDc	$\phi Dc1$	ap	θ°	A	W	$\phi D1$	$\phi D2$	ae
HXLN04M020M10R02	20	12	1.3	4.9	0.75	4.1	27	38	15.5
HXLN04M025M12R03	25	17	1.3	3	0.75	4.1	37	48	20.5
HXLN04M032M16R04	32	24	1.3	2	0.75	4.1	51	62	27.5

TOOL GEOMETRY FOR PROGRAMMING

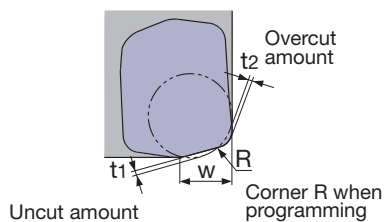

Max. depth of cut max. ap (in)	W (in)	Programmed corner R (in)	Amount left uncut $t1$ (in)	Amount left overcut $t2$ (in)
0.051	0.161	R0.059	0.031	0
0.051	0.161	R0.079	0.026	0
0.051	0.161	R0.098	0.020	0.002
0.051	0.161	R0.118	0.014	0.008



MEMO

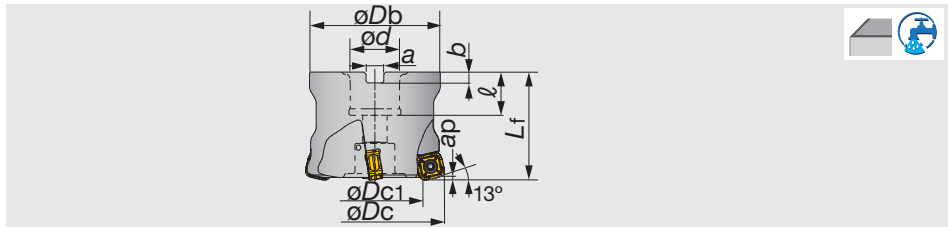

A.R. = +7°, R.R. = -8° ~ -4.5°

Inch	Max. ap	ϕDc	z	$\phi Dc1$	ϕDb	L_f	ϕd	ℓ	a	b	lb	Air hole	Insert
TXQ12R200U0075A03	0.079	2.000	3	1.362	1.850	1.969	0.750	0.750	0.315	0.197	1.120	with	SQMU1206ZSR-MJ
TXQ12R200U0075A04	0.079	2.000	4	1.362	1.850	1.969	0.750	0.750	0.315	0.197	1.120	with	SQMU1206ZSR-MJ
TXQ12R250U0075A04	0.079	2.500	4	1.862	2.323	1.969	0.750	0.750	0.315	0.197	1.760	with	SQMU1206ZSR-MJ
TXQ12R300U0100A05	0.079	3.000	5	2.362	2.835	1.969	1.000	1.024	0.374	0.236	3.770	with	SQMU1206ZSR-MJ
TXQ12R400U0150A06	0.079	4.000	6	3.362	3.780	1.969	1.500	1.457	0.626	0.394	5.710	with	SQMU1206ZSR-MJ
TXQ12R500U0150A07	0.079	5.000	7	4.362	3.780	1.969	1.500	1.457	0.626	0.394	7.010	with	SQMU1206ZSR-MJ
TXQ12R600U0200A08	0.079	6.000	8	5.37	3.937	2.480	2.000	1.496	0.748	0.433	7.350	with	SQMU1206ZSR-MJ

SPARE PARTS



Designation	Clamping screw	Grip	Lubricant	Torx bit	Center bolt (Optional parts)
TXQ12R**U0075A...	CSPB-4	H-TBS	M-1000	BLDIP15/S7	(C0.375X1.125H)
TXQ12R300U0100A05	CSPB-4	H-TBS	M-1000	BLDIP15/S7	(C0.500X1.375H)
TXQ12R**U0150A...	CSPB-4	H-TBS	M-1000	BLDIP15/S7	(TMBA-0.750H)
TXQ12R600U0200A08	CSPB-4	H-TBS	M-1000	BLDIP15/S7	(TMBA-M24H)

INSERT

SQMU-MJ

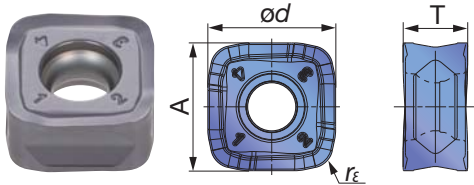

P Steel	☆	★	☆									
M Stainless		★	☆									
K Cast iron	★		☆									
N Non-ferrous												
S Superalloys	★	☆	★									
H Hard materials			★									

★ : First choice
☆ : Second choice

Designation	r_ϵ	Max. ap	Coated				A	T	ϕd
			AH120	AH130	AH725	T3130			
SQMU1206ZSR-MJ	0.079	0.079	●	●	●	●	0.461	0.236	0.461

● : Line up

Reference pages

Standard cutting conditions → D022 - D023

STANDARD CUTTING CONDITIONS

ISO	Workpiece material	Hardness	Priority	Grade	Cutting speed Vc (sfm)	Feed per tooth fz (ipt)	
P	High carbon steels (1045, 1055 etc.)	~ 300HB	First choice	AH725	330 - 980	0.020 - 0.080	
			For wear resistance	T3130	330 - 980	0.020 - 0.080	
			For impact resistance	AH130	330 - 980	0.020 - 0.080	
	Alloyed steels (4140 etc.)	~ 300HB	First choice	AH725	330 - 660	0.020 - 0.060	
			For wear resistance	T3130	330 - 660	0.020 - 0.060	
			For impact resistance	AH130	330 - 660	0.020 - 0.060	
Prehardened steels (NAK80, PX5, etc.)	30 ~ 40HRC	-	AH725	330 - 660	0.020 - 0.040		
M	Stainless steel (304, 316 etc.)	~ 200HB	-	AH130	330 - 500	0.012 - 0.030	
K	Gray cast iron (No.25, No.30 etc.)	-	-	AH120	100 - 300	0.020 - 0.080	
	Ductile cast irons (60-40-18, 65-45-12 etc.)	-	-	AH120	260 - 660	0.020 - 0.080	
S	Titanium alloy (Ti-6Al-4V etc.)	~ 40HRC	-	AH725	100 - 200	0.012 - 0.028	
H	Hardened steels	(H13 etc.)	40 ~ 50HRC	-	AH725	260 - 43	0.004 - 0.012
		(D2 etc.)	50 ~ 60HRC	-	AH725	160 - 230	0.001 - 0.003

- Slot or pocket milling is not recommended, since chip re-cutting easily occurs.
- Tool overhang length must be as short as possible to avoid chatter. When the tool overhang length is long, decrease the number of revolutions and feed.

- Cutting conditions are generally limited by the rigidity and power of the machine and the rigidity of the workpiece. When setting the conditions, start from half of the values of the standard cutting conditions and then increase the value gradually while making sure the machine is running normally.



Tool dia.: ϕD_c (in), Number of revolutions: n (rpm), Feed speed: V_f (ipm), Max. depth of cut: $a_p = 0.079''$

$\phi 2.000$		$\phi 2.500$		$\phi 3.000$		$\phi 4.000$		$\phi 5.000$	
n	V_f	n	V_f	n	V_f	n	V_f	n	V_f
1,260	227	1,010	242	790	237	630	227	500	210
$V_c = 660 \text{ sfm}, f_z = 0.060 \text{ ipt}$									
950	114	750	120	590	118	470	113	380	106
$V_c = 500 \text{ sfm}, f_z = 0.040 \text{ ipt}$									
950	86	750	90	590	89	470	85	380	80
$V_c = 490 \text{ sfm}, f_z = 0.030 \text{ ipt}$									
760	46	600	48	470	47	380	46	300	42
$V_c = 400 \text{ sfm}, f_z = 0.020 \text{ ipt}$									
1,260	227	1,010	242	790	237	630	227	500	210
$V_c = 660 \text{ sfm}, f_z = 0.060 \text{ ipt}$									
950	171	750	180	590	177	470	170	380	160
$V_c = 500 \text{ sfm}, f_z = 0.060 \text{ ipt}$									
250	15	200	16	150	15	120	14	100	14
$V_c = 130 \text{ sfm}, f_z = 0.020 \text{ ipt}$									
630	15	500	16	390	16	310	15	250	14
$V_c = 330 \text{ sfm}, f_z = 0.008 \text{ ipt}$									
380	2	300	2	240	2	190	2	150	2
$V_c = 200 \text{ sfm}, f_z = 0.002 \text{ ipt}$									

Super high-feed milling cutter with large depth of cut; Bore type

A.R. = +5°, R.R. = 0°

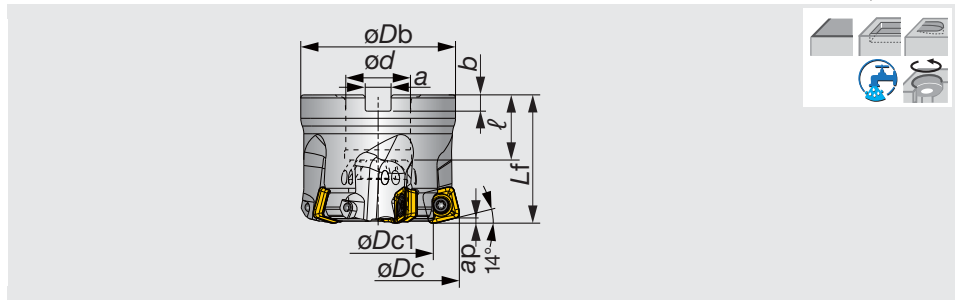

Inch	Max. ap	ϕDc	z	ϕDc_1	ϕDb	L_f	ϕd	ℓ	a	b	lb	Air hole	Insert
TXSW15U2.00B0.75R03	0.098	2.000	3	0.929	1.850	1.969	0.750	0.750	0.315	0.197	0.947	with	SWMT15...
TXSW15U2.50B0.75R04	0.098	2.500	4	1.480	2.323	1.969	0.750	0.750	0.315	0.197	1.520	with	SWMT15...
TXSW15U3.00B1.00R05	0.098	3.000	5	1.980	2.835	2.480	1.000	1.024	0.374	0.236	2.710	with	SWMT15...
TXSW15U4.00B1.50R06	0.098	4.000	6	2.980	3.819	2.480	1.500	1.063	0.626	0.394	4.870	with	SWMT15...
TXSW15U5.00B1.50R07	0.098	5.000	7	3.980	3.819	2.480	1.500	1.614	0.626	0.394	6.370	with	SWMT15...
TXSW15U6.00B2.00R08	0.098	6.000	8	4.980	4.331	2.480	2.000	1.496	0.748	0.433	8.290	with	SWMT15...

SPARE PARTS



Designation	Clamping screw	Grip	Lubricant	Torx bit	Shell locking bolt	Center bolt (Optional parts)
TXSW15U2.00B0.75R03	TS50115I	H-TB2W	M-1000	BT20S	SR 5/16-32UNEF_3/8-24UNF	-
TXSW15U2.50B0.75R04	TS50115I	H-TB2W	M-1000	BT20S	-	(SD06-A 6)
TXSW15U3.00B1.00R05	TS50115I	H-TB2W	M-1000	BT20S	-	(C0.500X1.375H)
TXSW15U4.00B1.50R06	TS50115I	H-TB2W	M-1000	BT20S	-	(SD-12-99)
TXSW15U5.00B1.50R07	TS50115I	H-TB2W	M-1000	BT20M	-	(TMBA-0.750H)
TXSW15U6.00B2.00R08	TS50115I	H-TB2W	M-1000	BT20M	-	-

INSERT

SWMT-MJ

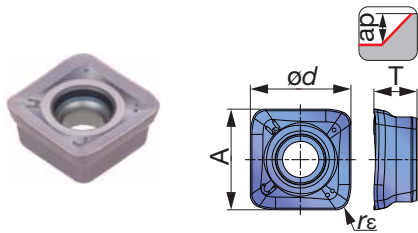

P Steel	☆	★										
M Stainless		★										
K Cast iron	★											
N Non-ferrous												
S Superalloys	★	☆										
H Hard materials	★	★										

★ : First choice
☆ : Second choice

Designation	r _ε	Max. ap	Coated		A	φd	T
			AH120	AH3135			
SWMT1506ZER-MJ	0.079	0.098	●	●	0.625	0.625	0.268

● : Line up

Reference pages

Standard cutting conditions → **D025**

STANDARD CUTTING CONDITIONS

ISO	Workpiece materials	Hardness	Priority	Grades	Chip-breaker	Cutting speed Vc (sfm)	Feed per tooth fz (ipt)	
P	Low carbon steel (1015, etc.)	- 300 HB	First choice	AH3135	MJ	330 - 1000	0.02 - 0.08	
		- 300 HB	Second choice	AH120	MJ	330 - 1000	0.02 - 0.08	
	Carbon steel and alloy steel (1015, 4140, etc.)	- 300 HB	First choice	AH3135	MJ	330 - 660	0.02 - 0.08	
		- 300 HB	Second choice	AH120	MJ	330 - 660	0.02 - 0.08	
	Prehardened steel (NAK80, PX5, etc.)	30 - 40 HRC	First choice	AH3135	MJ	330 - 660	0.02 - 0.06	
30 - 40 HRC		Second choice	AH120	MJ	330 - 660	0.02 - 0.06		
M	Stainless steel (S30400, S31600, etc.)	- 200 HB	First choice	AH3135	MJ	330 - 500	0.012 - 0.04	
K	Grey cast iron (No.250B, No.300B, etc.)	150 - 250 HB	First choice	AH120	MJ	330 - 1000	0.02 - 0.08	
	Ductile cast iron (60-40-18, 80-55-06, etc.)	150 - 250 HB	First choice	AH120	MJ	260 - 660	0.02 - 0.08	
S	Titanium alloys (Ti-6Al-4V, etc.)	- 40 HRC	First choice	AH3135	MJ	100 - 200	0.012 - 0.028	
	Superalloys (Inconel718, etc.)	- 40 HRC	First choice	AH120	MJ	60 - 160	0.004 - 0.012	
H	Hardened steel	(H13, etc.)	40 - 50 HRC	First choice	AH3135	MJ	260 - 420	0.004 - 0.012
		(D2, etc.)	50 - 60 HRC	First choice	AH120	MJ	160 - 230	0.001 - 0.003

APPLICATION RANGE

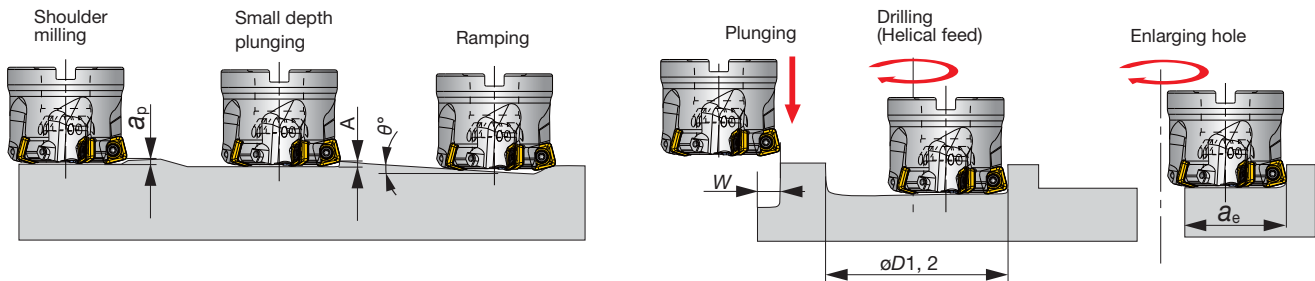

Inch	ϕDc	Max. depth of cut ap	Max. plunging A	Max. ramping angle θ°	Max. cutting width in plunging W	Min. machining dia. $\phi D1$	Max. machining dia. $\phi D2$	Max. cutting width in enlarging ae
TXSW15U2.00B0.75R03	2.000	0.098	0.028	4.6	0.591	2.787	3.771	1.433
TXSW15U2.50B0.75R04	2.500	0.098	0.028	2.9	0.591	3.819	4.803	1.949
TXSW15U3.00B1.00R05	3.000	0.098	0.028	2.1	0.591	4.819	5.803	2.449
TXSW15U4.00B1.50R06	4.000	0.098	0.028	1.4	0.591	6.819	7.803	3.449
TXSW15U5.00B1.50R07	5.000	0.098	0.028	1.0	0.591	8.819	9.803	4.449
TXSW15U6.00B2.00R08	6.000	0.098	0.028	0.8	0.591	10.819	11.803	5.449

TOOL GEOMETRY FOR PROGRAMMING

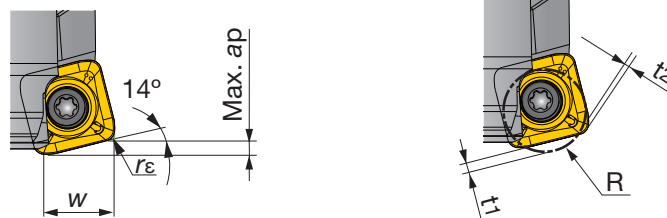

Max. ap (in)	Actual corner radius r_e (in)	W (in)	Programmed corner radius R (in)	Uncut amount t_1 (in)	Overcut amount t_2 (in)
0.098	0.079	0.500	0.157	0.078	-
0.098	0.079	0.500	0.177	0.074	-
0.098	0.079	0.500	0.197	0.070	0.0004

- When programming for CAM, the tool should be considered as a radius cutter. Usually, the corner radius should be set in $R = 0.177''$.

If a larger radius is used, overcutting may occur. The above table shows the uncut (t_1) and overcut (t_2) amounts for the programmed corner radius.

**MILLFEED**

TXP05/06/08/09

Super high feed milling cutter

A.R. = +5°, R.R. = -4° ~ -6°

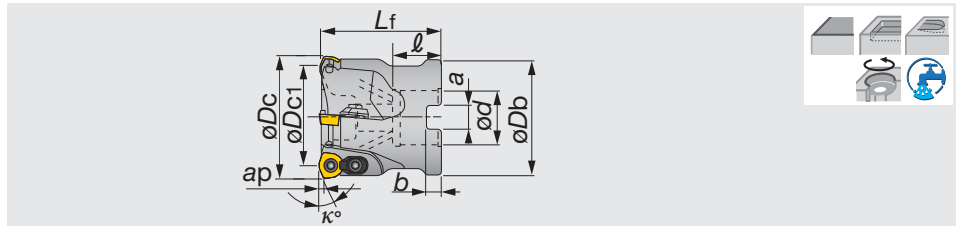

Inch	Max. ap	øDc	z	øDc1	øDb	Lf	ød	ℓ	a	b	κ°	lb	Air hole	Insert
TXP05250RBU	0.060	2.500	6	2.190	2.323	1.969	0.750	0.750	0.315	0.197	15	1.76	with	WPMT05...
TXP05300RBU	0.060	3.000	7	2.690	2.835	2.480	1.000	1.024	0.374	0.236	20	3.31	with	WPMT05...
TXP06200RBU	0.060	2.000	4	1.650	1.850	1.969	0.750	0.750	0.315	0.197	20	1.10	with	WPMT06...
TXP06250RBU	0.060	2.500	5	2.150	2.323	1.969	0.750	0.750	0.315	0.197	20	1.76	with	WPMT06...
TXP06300RBU	0.060	3.000	6	2.650	2.835	2.480	1.000	1.024	0.374	0.236	20	3.09	with	WPMT06...
TXP08050RU	0.060	2.000	3	1.547	1.850	1.969	0.750	0.750	0.315	0.197	10	0.87	without	WPMT08...
TXP08200RU-A	0.060	2.000	3	1.547	1.850	1.969	0.750	0.750	0.315	0.197	10	0.87	with	WPMT08...
TXP08300RU-A	0.060	3.000	5	2.547	2.835	2.480	1.000	1.024	0.375	0.236	10	3.20	with	WPMT08...
TXP08400RU-A	0.060	4.000	6	3.547	3.819	2.480	1.500	1.260	0.625	0.394	10	5.80	with	WPMT08...
TXP09250RU	0.118	2.500	3	1.971	2.323	1.969	0.750	0.750	0.315	0.197	20	1.54	with	WPMT09...
TXP09300RU	0.118	3.000	4	2.470	2.835	2.480	1.000	1.024	0.374	0.236	20	2.65	with	WPMT09...
TXP09400RU	0.118	4.000	5	3.471	3.780	2.480	1.500	1.457	0.626	0.394	20	4.41	with	WPMT09...
TXP09500RU	0.118	5.000	6	4.471	3.780	2.480	1.500	1.457	0.626	0.394	20	6.83	with	WPMT09...
TXP09600RU	0.118	6.000	7	5.471	4.331	2.480	2.000	1.496	0.748	0.433	20	9.48	without	WPMT09...

SPARE PARTS

Designation	Clamp set	Clamping screw	Lubricant	Wrench	Wrench 1	Center bolt (Optional parts)
TXP05...	-	CSPB-3.5S	M-1000	IP-15D	-	(C0.375X1.125H)
TXP06200RBU, TXP06250RBU	CSY-15	CSPB-4S	M-1000	IP-15D	-	(C0.375X1.125H)
TXP06300RBU	CSY-15	CSPB-4S	M-1000	IP-15D	-	(C0.500X1.375H)
TXP08...	CSX20	CSTB-5	M-1000	-	T-20T	-
TXP09250RU	CSY-20	CSPB-5	M-1000	-	IP-20T	(C0.375X1.125H)
TXP09300RU	CSY-20	CSPB-5	M-1000	-	IP-20T	(C0.500X1.375H)
TXP09400RU, TXP09500RU	CSY-20	CSPB-5	M-1000	-	IP-20T	(TMBA-0.750H)
TXP09600RU	CSY-20	CSPB-5	M-1000	-	IP-20T	-

Reference pages

Inserts → **D028**, Standard cutting conditions → **D029 - D030**

EXP05/06/09

Super high feed endmill

A.R. = +5°, R.R. = -6°

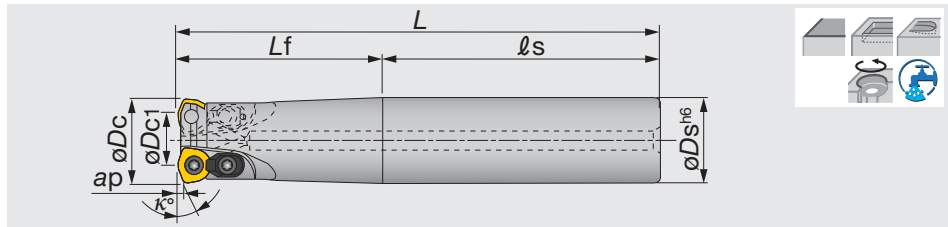

Inch	Max. ap	øDc	z	øDc1	øDs	L	Lf	ls	κ°	Air hole	Insert	shank
EXP05075RSU	0.060	0.750	2	0.480	0.750	4.030	2.000	2.031	15	with	WPM*05H315ZPR	Weldon
EXP05075RLU	0.060	0.750	2	0.480	0.750	4.030	2.000	2.031	15	with	WPM*05H315ZPR	Straight
EXP05075RLLU	0.060	0.750	2	0.480	0.750	7.000	4.000	3.000	15	with	WPM*05H315ZPR	Straight
EXP06100RSU	0.060	1.000	2	0.697	1.000	8.000	5.000	3.000	15	with	WPM*06X415ZPR	Weldon
EXP06100RLU	0.060	1.000	2	0.697	1.000	8.000	5.000	3.000	15	with	WPM*06X415ZPR	Straight
EXP06100RLLU	0.060	1.000	2	0.697	1.000	12.000	7.000	5.000	15	with	WPM*06X415ZPR	Straight
EXP06125RSBU	0.060	1.250	3	0.929	1.250	5.281	3.000	2.281	20	with	WPM*06X415ZPR	Weldon
EXP06125RLBU	0.060	1.250	3	0.929	1.250	8.000	5.000	3.000	20	with	WPM*06X415ZPR	Straight
EXP06125RLLBU	0.060	1.250	3	0.929	1.250	12.000	7.000	5.000	20	with	WPM*06X415ZPR	Straight
EXP06150RSU	0.060	1.500	3	1.169	1.250	5.781	3.500	2.281	20	with	WPM*06X415ZPR	Weldon
EXP06150RLU	0.060	1.500	3	1.169	1.250	10.000	2.000	8.000	20	with	WPM*06X415ZPR	Straight
EXP06150RLLU	0.060	1.500	3	1.169	1.250	12.000	2.000	10.000	20	with	WPM*06X415ZPR	Straight
EXP09200RU	0.118	2.000	2	1.477	1.250	4.781	2.500	2.281	20	with	WPMT090725Z*R	Weldon
EXP09200RLU	0.118	2.000	2	1.477	1.250	9.750	2.000	7.750	20	with	WPMT090725Z*R	Straight

SPARE PARTS

Designation	Clamp set	Clamping screw	Lubricant	Wrench	Wrench 1
EXP05...	-	C-SPB-3.5S	M-1000	IP-15D	-
EXP06...	CSY-15	CSPB-4S	M-1000	IP-15D	-
EXP09...	CSY-20	CSPB-5	M-1000	-	IP-20T

Reference pages

Inserts → **D028**, Standard cutting conditions → **D029 - D030**



INSERT

WPMW05/06

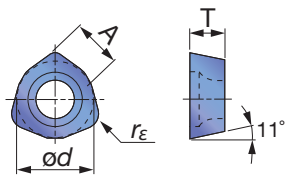

WPMT08/09

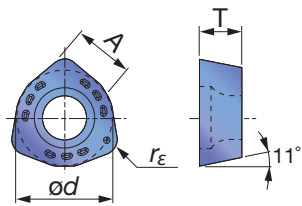

WPMT05/06/08/09-ML

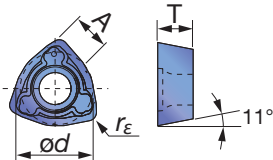

WPMT05/06/08/09-MH

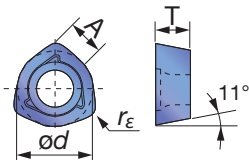

WPMT05/06/08/09-DML

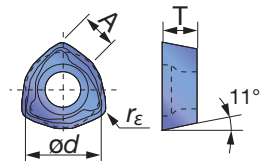

P Steel	★				★	★														
M Stainless		★	★		☆															
K Cast iron	★																			
N Non-ferrous																				
S Superalloys	★	☆																		
H Hard materials					★															

★ : First choice
☆ : Second choice

Designation	rc	Max. ap	Coated							A	ød	T
			AH120	AH130	AH140	AH730	AH330	T3130				
WPMW05H315ZPR	0.059	0.060	●		●			●		0.197	0.3130	0.138
WPMT05H315ZPR-ML	0.059	0.060	●		●			●		0.197	0.3130	0.138
WPMT05H315ZPR-MH	0.059	0.060	●		●					0.197	0.3134	0.138
WPMT05H315ZPR-DML	0.059	0.060					●			0.197	0.3130	0.138
WPMW06X415ZPR	0.059	0.060	●		●			●		0.236	0.3750	0.165
WPMT06X415ZPR-ML	0.059	0.060	●	●	●			●		0.236	0.3750	0.165
WPMT06X415ZPR-MH	0.059	0.060	●		●					0.236	0.3755	0.165
WPMT06X415ZPR-DML	0.059	0.060					●			0.236	0.3750	0.165
WPMT080615ZSR	0.059	0.060	●	●	●			●	●	0.315	0.507	0.250
WPMT080615ZPR-ML	0.059	0.060	●	●	●			●		0.315	0.507	0.250
WPMT080615ZSR-MH	0.059	0.060	●		●					0.315	0.507	0.250
WPMT080615ZPR-DML	0.059	0.060					●			0.315	0.507	0.250
WPMT090725ZSR	0.098	0.118	●		●			●		0.354	0.591	0.276
WPMT090725ZPR-ML	0.098	0.118	●	●	●			●		0.354	0.591	0.276
WPMT090725ZSR-MH	0.098	0.118	●	●	●					0.354	0.591	0.276
WPMT090725ZPR-DML	0.098	0.118					●			0.354	0.591	0.276

●: Line up

STANDARD CUTTING CONDITIONS

05-06 type



High-Feed Milling

ISO	Workpiece material	Insert grade	Cutting speed Vc (sfm)	Feed per tooth fz (ipt)	ø0.750" (z = 2)	ø1.000" (z = 2)	ø1.250" (z = 2, 3)	ø1.500" (z = 3)	ø2.500" (z = 5, 6)	ø3.000" (z = 6, 7)
P	Carbon Steels 1055, etc. < 300HB	AH120 (T3130)	330 ~ 820	0.020 ~ 0.078	Vc = 500 sfm, fz = 0.031 ipt ap = 0.039", ae = 0.039D"	Vc = 500 sfm, fz = 0.039 ipt ap = 0.039", ae = 0.039D"				
	When plunging in small depth: fz = 0.008"									
	Alloy steels 4140, etc. < 300 HB	AH120 (T3130)	330 ~ 650	0.020 ~ 0.078	Vc = 425 sfm, fz = 0.031 ipt ap = 0.039", ae = 0.039D"	Vc = 425 sfm, fz = 0.039 ipt ap = 0.039", ae = 0.039D"				
When plunging in small depth: fz = 0.008"										
M	Prehardened steels P20, H13, etc. 30 ~ 40HRC	AH120 (T3130)	260 ~ 500	0.020 ~ 0.039	Vc = 330 sfm, fz = 0.020 ipt ap = 0.039", ae = 0.039D"	Vc = 330 sfm, fz = 0.020 ipt ap = 0.039", ae = 0.039D"				
	When plunging in small depth: fz = 0.004 ipt									
K	Stainless steels S30400, etc.	AH130 AH140	330 ~ 650	0.020 ~ 0.078	Vc = 425 sfm, fz = 0.031 ipt ap = 0.039", ae = 0.039D"	Vc = 425 sfm, fz = 0.039 ipt ap = 0.039", ae = 0.039D"				
	When plunging in small depth: fz = 0.008 ipt									
S	Cast irons 250, etc.	AH120	330 ~ 820	0.032 ~ 0.098	Vc = 500 sfm, fz = 0.039 ipt ap = 0.039", ae = 0.039D"	Vc = 590 sfm, fz = 0.059 ipt ap = 0.039", ae = 0.039D"				
	When plunging in small depth: fz = 0.008 ipt									
	Titanium alloys Ti-6Al-4V, etc.	AH130	98 ~ 197	0.012 ~ 0.028	Vc = 164 sfm, fz = 0.020 ipt, ap = 0.028", ae = 0.020D"					
When plunging in small depth: fz = 0.004 ipt										
H	Heat-resistant alloys Inconel 718, etc.	AH120	33 ~ 131	0.004 ~ 0.012	Vc = 98 sfm, fz = 0.008 ipt, ap = 0.028", ae = 0.020D"					
	When plunging in small depth: fz = 0.004 ipt									
H	Hard materials D2, etc. 40 ~ 50HRC	AH730	200 ~ 330	0.020 ~ 0.078	Vc = 230 sfm, fz = 0.028 ipt, ap = 0.028", ae = 0.039D"					
	When plunging in small depth: fz = 0.004 ipt									

08 type

ISO	Workpiece material	Insert grade	Cutting speed Vc (sfm)	Feed per tooth fz (ipt)	ø2.000" (z = 3)	ø3.000" (z = 4)	ø4.000" (z = 6)
P	Carbon Steels 1055, etc. < 300HB	AH120 (T3130)	330 ~ 820	0.020 ~ 0.078	Vc = 650 sfm, fz = 0.059 ipt ap = 0.039", ae = 0.039D"		
	When plunging in small depth: fz = 0.008 ipt						
	Alloy steels 4140, etc. < 300 HB	AH120 (T3130)	330 ~ 650	0.020 ~ 0.078	Vc = 500 sfm, fz = 0.059 ipt ap = 0.039", ae = 0.039D"		
When plunging in small depth: fz = 0.008 ipt							
M	Prehardened steels P20, H13, etc. 30 ~ 40HRC	AH120 (T3130)	260 ~ 500	0.020 ~ 0.039	Vc = 120 sfm, fz = 0.031 ipt ap = 0.039", ae = 0.039D"		
	When plunging in small depth: fz = 0.004 ipt						
K	Stainless steels S30400, etc.	AH130 AH140	330 ~ 650	0.020 ~ 0.078	Vc = 500 sfm, fz = 0.059 ipt ap = 0.039", ae = 0.039D"		
	When plunging in small depth: fz = 0.008 ipt						
S	Cast irons 250, etc.	AH120	500 ~ 820	0.032 ~ 0.098	Vc = 650 sfm, fz = 0.078 ipt ap = 0.039", ae = 0.039D"		
	When plunging in small depth: fz = 0.008 ipt						
	Titanium alloys Ti-6Al-4V, etc.	AH130	98 ~ 197	0.012 ~ 0.028	Vc = 164 sfm, fz = 0.020 ipt, ap = 0.028", ae = 0.020D"		
When plunging in small depth: fz = 0.004 ipt							
H	Heat-resistant alloys Inconel 718, etc.	AH120	33 ~ 131	0.004 ~ 0.012	Vc = 98 sfm, fz = 0.008 ipt, ap = 0.028", ae = 0.020D"		
	When plunging in small depth: fz = 0.004 ipt						
H	Hard materials D2, etc. 40 ~ 50HRC	AH730	170 ~ 260	0.020 ~ 0.039	Vc = 230 sfm, fz = 0.078 ipt ap = 0.087", ae = 0.039D"		
	When plunging in small depth: fz = 0.004 ipt						

Note: •The above values of cutting speed show the standard speed when overhang length of tool is below 3D. The cutting speed and the feed rate should be set at the lower limit values when overhang length of tool exceeds 3D.
•Thick and heavy chips are discharged by these TAC mills. Use internal air supply or air-blowing in order to prevent tool failure.

STANDARD CUTTING CONDITIONS

09 type

ISO	Workpiece material	Insert grade	Cutting speed Vc (sfm)	Feed per tooth fz (ipt)	ø2.000 (z = 2)	ø2.500 (z = 3)	ø3.000 (z = 4)	ø4.000 (z = 5)	ø5.000 (z = 6)	ø6.000 (z = 7)	
P	Carbon Steels 1055, etc. < 300HB	AH120 (T3130)	330 ~ 820	0.020 ~ 0.078	Vc = 650 sfm, fz = 0.059 ipt, ap = 0.079", ae = 0.039D"						
	When plunging in small depth: fz = 0.008 ipt										
	Alloy steels 4140, etc. < 300 HB	AH120 (T3130)	330 ~ 650	0.020 ~ 0.078	Vc = 500 sfm, fz = 0.059 ipt, ap = 0.079", ae = 0.039D"						
When plunging in small depth: fz = 0.008 ipt											
M	Prehardened steels P20, H13, etc. 30 ~ 40HRC	AH120 (T3130)	260 ~ 500	0.020 ~ 0.039	Vc = 3.94, fz = 0.031 ipt, ap = 0.079", ae = 0.039D"						
	When plunging in small depth: fz = 0.004 ipt										
K	Stainless steels S30400, etc.	AH130 AH140	330 ~ 650	0.020 ~ 0.078	Vc = 500 sfm, fz = 0.059 ipt, ap = 0.079", ae = 0.039D"						
	When plunging in small depth: fz = 0.008 ipt										
S	Cast irons 250, etc.	AH120	500 ~ 820	0.032 ~ 0.098	Vc = 650 sfm, fz = 0.078 ipt, ap = 0.079", ae = 0.039D"						
	When plunging in small depth: fz = 0.008 ipt										
	Titanium alloys Ti-6Al-4V, etc.	AH130	98 ~ 197	0.012 ~ 0.028	Vc = 164 sfm, fz = 0.020 ipt, ap = 0.059", ae = 0.020D"						
When plunging in small depth: fz = 0.039 ipt											
H	Heat-resistant alloys Inconel 718, etc.	AH120	33 ~ 131	0.004 ~ 0.012	Vc = 98 sfm, fz = 0.008 ipt, ap = 0.039", ae = 0.020D"						
	When plunging in small depth: fz = 0.039 ipt										
H	Hard materials D2, etc. 40 ~ 50HRC	AH730	200 ~ 330	0.020 ~ 0.039	Vc = 230 sfm, fz = 0.028 ipt, ap = 0.027", ae = 0.039D"						
	When plunging in small depth: fz = 0.004 ipt										

Notes : The cutting speed and feed should be set to 70 to 80 % of the value shown in the above table when overhang length of tool exceeds 3D.

APPLICATION RANGE

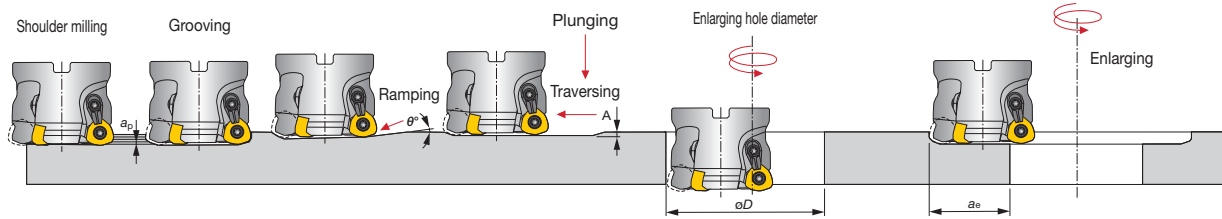

Inch	ϕD_c	Max. depth of cut a_p	Max. ramping angle θ°	Max. plunging depth A	Min. machining hole dia. ϕD	Max. machining hole dia. ϕD	Max. cutting width in enlarging hole a_e
TXP05250RBU	2.500	0.060	2° 30'	0.020	3.860	4.840	2.240
TXP05300RBU	3.000	0.060	1° 30'	0.020	5.200	6.180	2.910
TXP06250RBU	2.500	0.060	2°	0.040	3.860	4.840	2.240
TXP06200RBU	2.000	0.060	1° 30'	0.040	3.270	3.820	1.770
TXP06300RBU	3.000	0.060	1° 30'	0.040	5.200	6.180	2.910
TXP08050RU	2.000	0.060	4°	0.040	2.830	3.820	1.730
TXP08300RU-A	3.000	0.060	1° 30'	0.040	5.200	6.180	2.910
TXP08400RU-A	4.000	0.060	1°	0.040	6.770	7.760	3.700
TXP09250RU	2.500	0.118	2°	0.060	3.860	4.840	2.200
TXP09300RU	3.000	0.118	1° 30'	0.060	5.200	6.180	2.870
TXP09400RU	4.000	0.118	1°	0.060	6.770	7.760	3.660
TXP09500RU	5.000	0.118	0° 45'	0.060	8.740	9.720	4.650
TXP09600RU	6.000	0.118	0° 30'	0.060	11.500	12.480	6.020
EXP05075...	0.750	0.060	3°	0.020	1.181	1.457	0.630
EXP06100...	1.000	0.060	5°	0.039	1.299	1.850	0.787
EXP06125...	1.250	0.060	3° 30'	0.039	1.850	2.402	1.063
EXP06150...	1.500	0.060	2°	0.039	2.480	2.874	1.299
EXP09200...	2.000	0.118	1.5°	0.031	2.992	3.819	1.693

TOOL GEOMETRY FOR PROGRAMMING

When programming for CAD/CAM, the tool should be assumed to be a radius cutter shown in the table below. In this case, the amount left as uncut (t) is shown below.

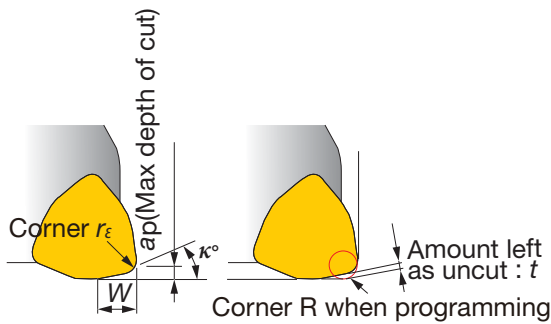

TXP	Max. depth of cut a_p	Corner of insert r_ϵ	Cutting edge angle κ°	W	t	Corner R when programming
05	0.060	0.059	20	0.150	0.020	R.078
06	0.060	0.059	20	0.169	0.028	R.078
08	0.060	0.059	20	0.224	0.028	R.078
09	0.118	0.098	20	0.268	0.055	R.118
09	0.118	0.098	20	0.268	0.047	R.157

MillLine - Shoulder Milling

								Inch	Metric
		DO FORCE	D034	90°	Economical and versatile shoulder mills with double-sided triangular inserts ø1.250" - ø5.000" max. ap 0.433"	P M K S		<input checked="" type="checkbox"/>	<input type="checkbox"/>
		TUNG-TRI	D038	90°	High-precision shoulder mills with single-sided triangular inserts ø0.472" - ø6.000" max. ap 0.591" / 3.268"	P M K N S		<input checked="" type="checkbox"/>	<input checked="" type="checkbox"/>
		TUNG TSHRED	D047	90°	Square shoulder milling cutters for roughing to produce shredded chips ø2.000" - ø4.000" max. ap 0.630" / 2.992"	P M K S		<input checked="" type="checkbox"/>	<input type="checkbox"/>
		TUNG FORCE REC	D050	90°	Mini square shoulder milling cutters for high productivity ø0.313" - ø0.625" max. ap 0.236"	P M K N S H		<input checked="" type="checkbox"/>	<input checked="" type="checkbox"/>
		TUNG REC	D054	90°	Excellent surface finish and wall accuracy in shoulder milling ø0.472" - ø6.299" max. ap 0.657"	P M K N S		<input checked="" type="checkbox"/>	<input checked="" type="checkbox"/>
		TUNG QUAD	D069	90°	Ideal tool for milling small parts on small machines ø0.500" - ø2.000" max. ap 0.157"	P M K N		<input checked="" type="checkbox"/>	<input type="checkbox"/>
		TUNG MILL	D072	90°	Single-sided inserts with low cutting force for shoulder milling ø1.260" - ø6.000" max. ap 0.394"	P M K N		<input checked="" type="checkbox"/>	<input checked="" type="checkbox"/>
		DO REC	D076	90°	Shoulder milling cutters for general purpose with 4-cornered double-sided inserts ø1.000" - ø6.000" max. ap 0.630"	P M K S		<input checked="" type="checkbox"/>	<input type="checkbox"/>
		TEC MILL	D079	90°	Shoulder milling cutters for heavy machining duty with 4-cornered tangentially mounted inserts ø1.250" - ø5.000" max. ap 0.594"	P M K S		<input checked="" type="checkbox"/>	<input type="checkbox"/>
		TUNG-ALUMILL	D081	90°	Highly polished and positive routing milling cutters for aluminum and non-ferrous metals ø1.000" - ø5.000" max. ap 0.630"	N		<input checked="" type="checkbox"/>	<input type="checkbox"/>
		Other Shoulder Milling Tools	D084		HYBRID TAC MILL EPH, TPS, EPS, EVH, EXH			<input checked="" type="checkbox"/>	<input checked="" type="checkbox"/>



DoForce-Tri

Tungaloy D033

Square Shoulder milling cutters with double-sided triangular insert

A.R. = +4.2°~ +4.7°, R.R. = -15.4°~ -11.2°

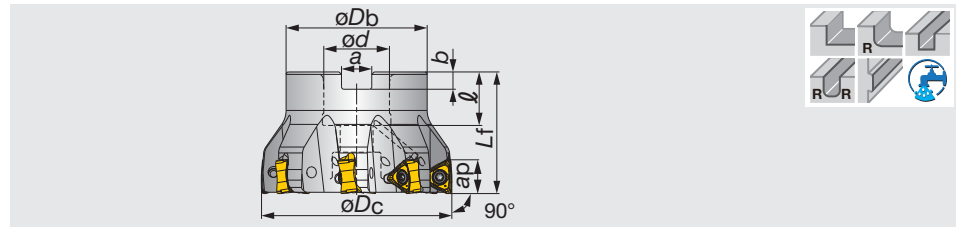

Shoulder Milling

Inch	Max. ap	ϕDc	z	ϕDb	L_f	ϕd	ℓ	a	b	lb	Air hole	Insert
TPTN12U2.00B0.75R05	0.433	2.000	5	1.850	1.575	0.750	0.750	0.315	0.197	0.890	with	TN*U12...
TPTN12U2.50B0.75R06	0.433	2.500	6	1.850	1.575	0.750	0.750	0.315	0.197	1.330	with	TN*U12...
TPTN12U3.00B1.00R08	0.433	3.000	8	2.835	1.969	1.000	1.024	0.374	0.236	2.440	with	TN*U12...
TPTN12U4.00B1.50R10	0.433	4.000	10	3.150	1.969	1.500	1.181	0.626	0.394	3.110	with	TN*U12...
TPTN12U5.00B1.50R12	0.433	5.000	12	3.150	2.480	1.500	1.181	0.626	0.394	5.330	with	TN*U12...

SPARE PARTS

Designation	Clamping screw	Grip	Torx bit	Lubricant	Center bolt (Optional parts)	Center bolt 1 (Optional parts)
TPTN12U2.00, 2.50...	CSPB-3.5	H-TB2W	BLDIP15/S7	M-1000	-	(C0.375X1.125H)
TPTN12U3.00B1.00R08	CSPB-3.5	H-TB2W	BLDIP15/S7	M-1000	-	(C0.500X1.375H)
TPTN12U4.00, 5.00...	CSPB-3.5	H-TB2W	BLDIP15/S7	M-1000	(TMBA-0.750S.375)	-

Square Shoulder milling endmills with double-sided triangular insert

A.R. = +4.2°~ +4.7°, R.R. = -15.4°~ -11.2°

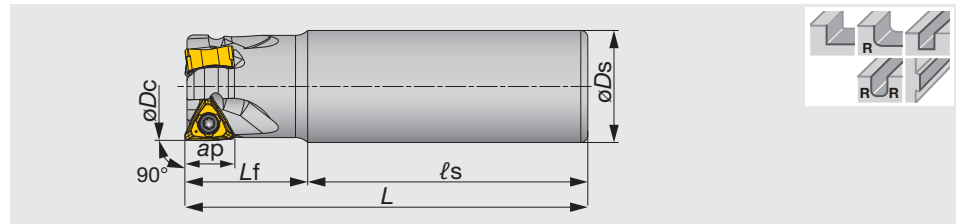

Inch	Max. ap	ϕDc	z	ϕDs	ℓ_s	L_f	L	lb	Air hole	Insert
EPTN12U1.25C1.25R03N	0.433	1.250	3	1.250	3.000	1.500	4.500	1.560	without	TN*U12...
EPTN12U1.50C1.25R04N	0.433	1.500	4	1.250	3.000	1.500	4.500	1.780	without	TN*U12...

SPARE PARTS

Designation	Clamping screw	Grip	Torx bit	Lubricant
EPTN12...	CSPB-3.5	H-TB2W	BLDIP15/S7	M-1000

Reference pages

Inserts → D035, Standard cutting conditions → D036

INSERT

TNGU-MJ / TNMU-MJ

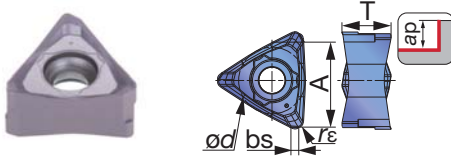

TNGU-NMJ / TNMU-NMJ

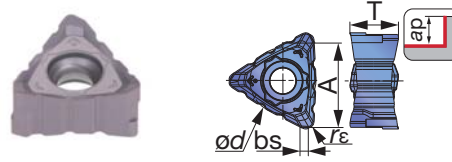

TNMU-R-MJ

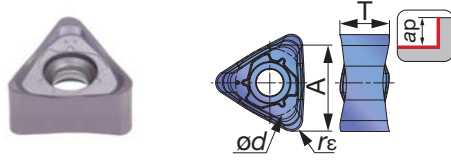

P Steel	☆	★		☆
M Stainless		★		☆
K Cast iron	★		☆	
N Non-ferrous				
S Superalloys	★	☆		
H Hard materials				

★ : First choice
☆ : Second choice

Designation	rε	Max. ap	Coated				A	ød	T	bs
			AH120	AH3135	T1215	T3225				
TNGU120708PER-MJ	0.031	0.433	●	●			0.472	0.375	0.277	0.046
TNGU120708PER-NMJ	0.031	0.433	●	●			0.472	0.375	0.277	0.046
TNMU1207R16PER-MJ	0.063	0.433	●	●			0.472	0.375	0.277	-
TNMU120708PER-MJ	0.031	0.433	●	●	●	●	0.472	0.375	0.277	0.046
TNMU120708PER-NMJ	0.031	0.433	●	●			0.472	0.375	0.277	0.046

● : Line up



Shoulder Milling

STANDARD CUTTING CONDITIONS

ISO	Workpiece materials	Hardness	Priority	Grades	Chip-breaker	Cutting speed Vc (sfm)	Feed per tooth fz (ipt)
P	Low carbon steels (1018, 1026, etc.)	- 300 HB	First choice	AH3135	MJ	328 - 820	0.003 - 0.012
		- 300 HB	Priority on wear resistance	T3225	MJ	328 - 984	0.003 - 0.012
		- 300 HB	For low cutting force	AH3135	NMJ	328 - 820	0.003 - 0.006
	Carbon steels, Alloy steels (1055, 4140, etc.)	- 300 HB	First choice	AH3135	MJ	328 - 755	0.003 - 0.012
		- 300 HB	Priority on wear resistance	T3225	MJ	328 - 919	0.003 - 0.012
		- 300 HB	For low cutting force	AH3135	NMJ	328 - 919	0.003 - 0.006
	Prehardened steel (H-13, P-20, etc.)	30 - 40 HRC	First choice	AH3135	MJ	328 - 591	0.003 - 0.010
		30 - 40 HRC	Priority on wear resistance	T3225	MJ	328 - 656	0.003 - 0.010
		30 - 40 HRC	For low cutting force	AH3135	NMJ	328 - 591	0.003 - 0.006
M	Stainless steels (304, 316, etc.)	-	First choice	AH3135	MJ	295 - 656	0.003 - 0.010
		-	Priority on wear resistance	T3225	MJ	295 - 820	0.003 - 0.010
		-	For low cutting force	AH3135	NMJ	295 - 656	0.003 - 0.006
K	Grey cast irons (Class 25, Class 30, etc.)	150 - 250 HB	First choice	AH120	MJ	459 - 820	0.003 - 0.012
		150 - 250 HB	Priority on wear resistance	T1215	MJ	459 - 984	0.003 - 0.012
		150 - 250 HB	For low cutting force	AH120	NMJ	459 - 820	0.003 - 0.006
	Ductile cast irons (60-40-18, 80-55-06, etc.)	150 - 250 HB	First choice	AH120	MJ	361 - 656	0.003 - 0.010
		150 - 250 HB	Priority on wear resistance	T1215	MJ	361 - 820	0.003 - 0.010
		150 - 250 HB	For low cutting force	AH120	NMJ	361 - 656	0.003 - 0.006
S	Titanium alloys (Ti-6Al-4V, etc.)	-	First choice	AH120	MJ	70 - 200	0.003 - 0.008
		-	For low cutting force	AH120	NMJ	70 - 200	0.003 - 0.006
	Heat-resistant alloys (Inconel718, etc.)	-	First choice	AH120	MJ	70 - 130	0.003 - 0.007
		-	For low cutting force	AH120	NMJ	70 - 130	0.003 - 0.006

When you use the NMJ chipbreaker, please set up the feed less than 0.006 ipt.

Shoulder Milling

MEMO

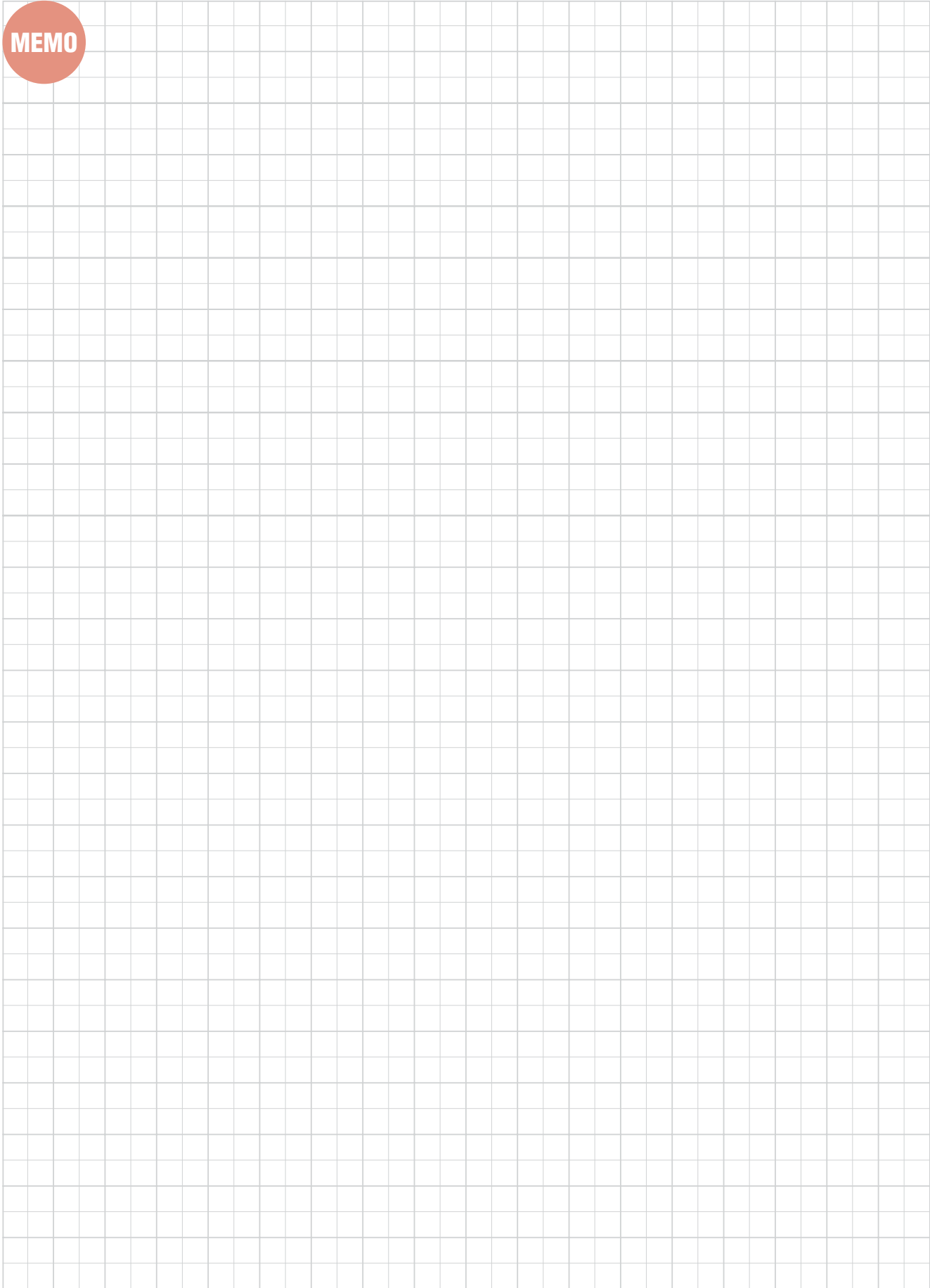

Shoulder Milling

TUNG-TRI

TPA06

High precision square shoulder milling cutters with triangular inserts

A.R. = +8.5°~ +11.5°, R.R. = -5.5°~ -12.5°

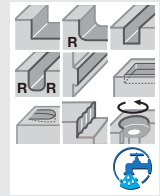
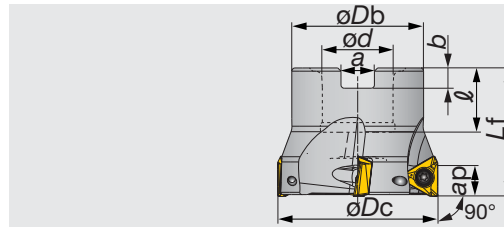

Shoulder Milling

Inch	Max. ap	ϕDc	z	ϕDb	ϕd	ℓ	L_f	b	a	lb	Air hole	Insert
TPA06R200U0075A08	0.236	2.000	8	1.693	0.750	0.750	1.575	0.197	0.315	0.310	with	TOMT06...

SPARE PARTS

Designation	Clamping screw	Lubricant	Wrench	Center bolt (Optional parts)
TPA06R200U0075A08	CSTB-2.5	M-1000	T-8D	(C0.375X1.125H)

TUNG-TRI

EPA06

High precision square shoulder milling endmills with triangular inserts

A.R. = +8.5°~ +11.5°, R.R. = -5.5°~ -12.5°

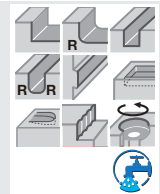
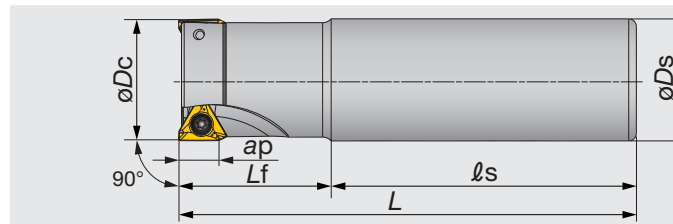

Inch	Max. ap	ϕDc	z	ϕDs	ℓ_s	L_f	L	lb	Air hole	Insert
EPA06R050U0050-01N	0.236	0.500	1	0.500	2.250	0.750	3.000	0.200	without	TOMT06...
EPA06R063U0063-02N	0.236	0.625	2	0.625	2.563	0.937	3.500	0.260	without	TOMT06...
EPA06R075U0075-03N	0.236	0.750	3	0.750	2.858	1.142	4.000	0.440	with	TOMT06...
EPA06R100U0100W04N	0.236	1.000	4	1.000	2.280	1.500	3.780	0.290	without	TOMT06...

SPARE PARTS

Designation	Clamping screw	Lubricant	Wrench
EPA06...	$\phi Dc \leq 0.625"$	CSTB-2.5S	M-1000
	$\phi Dc \geq 0.750"$	CSTB-2.5	M-1000

Reference pages

Inserts → **D044**, Standard cutting conditions → **D045**

TUNG-TRI

HPA06-M

High precision square shoulder milling endmills with triangular inserts

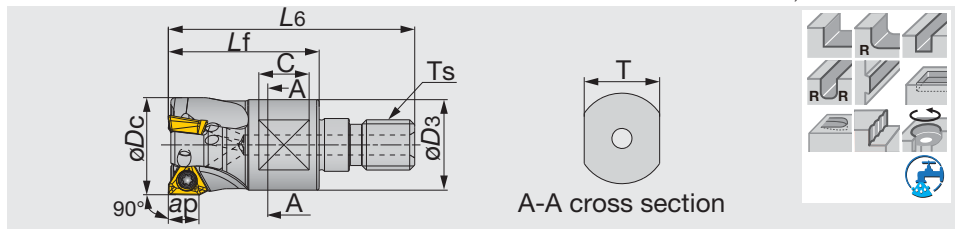

Metric	Max. ap	øDc	z	L6	Lf	C	T	øD3	Ts	lb	Air hole	Insert
HPA06R016MM08-02	6	16	2	42	25	8	10	13	M8	0.030	with	TOMT06...
HPA06R020MM10-03	6	20	3	49	30	10	15	18	M10	0.060	with	TOMT06...
HPA06R025MM12-04	6	25	4	57	35	10	17	21	M12	0.100	with	TOMT06...
HPA06R032MM16-05	6	32	5	63	40	12	22	29	M16	0.200	with	TOMT06...

See page D147 for TungFlex modular shank.

SPARE PARTS



Designation	Clamping screw	Lubricant	Wrench
HPA06R016MM08-02	CSTB-2.5S	M-1000	T-8D
HPA06R020 - 032MM...	CSTB-2.5	M-1000	T-8D

Shoulder Milling

TUNG-TRI

TPA10

High precision square shoulder milling cutters with triangular inserts

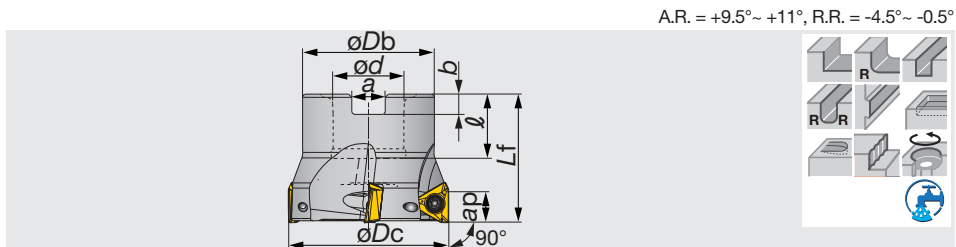

Inch	Max. ap	øDc	z	øDb	ød	l	Lf	b	a	lb	Air hole	Insert
TPA10R200U0075A04	0.394	2.000	4	1.693	0.750	0.750	1.575	0.197	0.315	0.440	with	TOMT10...
TPA10R250U0075A06	0.394	2.500	6	1.693	0.750	0.750	1.575	0.197	0.315	0.680	with	TOMT10...
TPA10R300U0100A07	0.394	3.000	7	2.283	1.000	1.024	1.969	0.236	0.374	1.120	with	TOMT10...
TPA10R400U0150A08	0.394	4.000	8	3.150	1.500	1.413	2.480	0.394	0.626	2.290	with	TOMT10...

SPARE PARTS



Designation	Clamping screw	Grip	Torx bit	Lubricant	Center bolt (Optional parts)
TPA10R200U - 300U...	SR14-562/S	SW6-SD	BLDT10/S7	M-1000	(C0.375X1.125H)
TPA10R400U0150A08	SR14-562/S	SW6-SD	BLDT10/S7	M-1000	-

Reference pages

Inserts → D044, Standard cutting conditions → D045

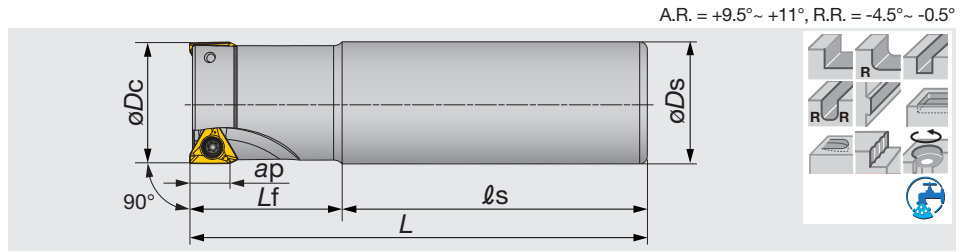

Inch	Max. ap	ϕD_c	z	ϕD_s	l_s	L_f	L	l _b	Air hole	Insert
EPA10R100U0075W02N	0.394	1.000	2	0.750	2.362	1.378	3.740	0.44	without	TOMT10...
EPA10R100U0100W02L	0.394	1.000	2	1.000	5.748	2.752	8.500	1.68	with	TOMT10...
EPA10R100U0100W02N	0.394	1.000	2	1.000	2.362	1.378	3.740	0.71	without	TOMT10...
EPA10R125U0125W02L	0.394	1.250	2	1.250	7.000	3.000	10.000	3.15	with	TOMT10...
EPA10R125U0125W03ML	0.394	1.250	3	1.250	4.250	2.250	6.500	2.07	with	TOMT10...
EPA10R125U0125W03N	0.394	1.250	3	1.250	2.362	1.378	3.740	1.12	without	TOMT10...
EPA10R150U0125W02L	0.394	1.500	2	1.250	8.000	2.000	10.000	3.33	with	TOMT10...
EPA10R150U0125W03ML	0.394	1.500	3	1.250	4.250	2.250	6.500	2.43	with	TOMT10...
EPA10R150U0125W04N	0.394	1.500	4	1.250	3.157	1.969	5.126	1.68	without	TOMT10...

SPARE PARTS

Designation	Clamping screw	Grip	Lubricant	Torx bit
EPA10...	SR14-562/S	SW6-SD	M-1000	BLDT10/S7

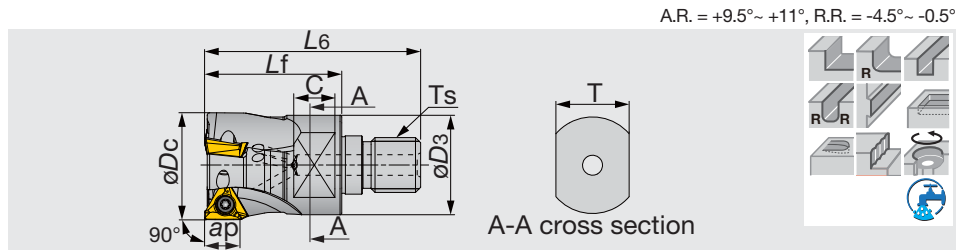

Metric	Max. ap	ϕD_c	z	L_6	L_f	C	T	ϕD_s	T_s	l _b	Air hole	Insert
HPA10R025MM12-02	10	25	2	57	35	10	17	21	M8	0.08	with	TOMT10...
HPA10R032MM16-03	10	32	3	63	40	12	22	29	M10	0.18	with	TOMT10...

SPARE PARTS

Designation	Clamping screw	Grip	Lubricant	Torx bit
HPA10...	SR14-562/S	SW6-SD	M-1000	BLDT10/S7

Reference pages

Inserts → **D044**, Standard cutting conditions → **D045**

A.R. = +9.5°~ +11°, R.R. = -4.5°~ -0.5°

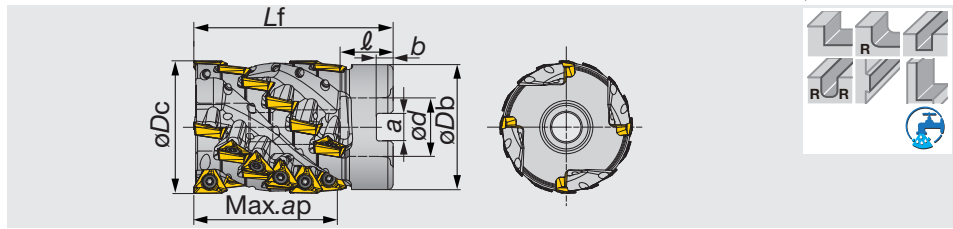

Inch	Max. ap	øDc	Z eff	z	øDb	ød	ℓ	Lf	b	a	lb	Air hole	Insert
TLA10R200L213U0075A04	2.126	2.000	4	24	1.875	0.750	0.750	3.250	0.197	0.315	1.760	with	TOMT10...
TLA10R250L213U0100A04	2.126	2.500	4	24	2.375	1.000	1.024	3.250	0.236	0.374	2.960	with	TOMT10...

SPARE PARTS

Designation	Clamping screw	Lubricant	Wrench	Center bolt
TLA10R200L213U0075A04	SR14-562	M-1000	T-10D	SD06-102
TLA10R250L213U0100A04	SR14-562	M-1000	T-10D	SD-08-C8

A.R. = +12°~ +13.5°, R.R. = -6°~ -3.5°

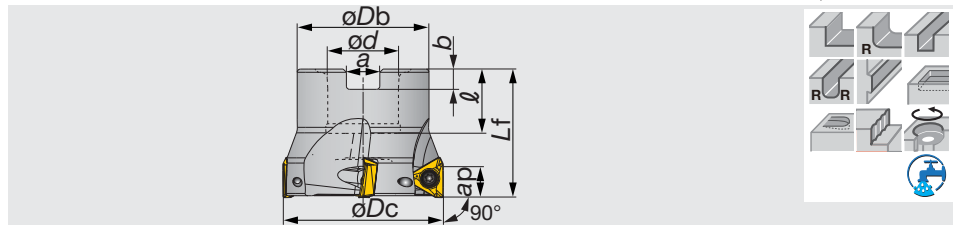

Inch	Max. ap	øDc	z	øDb	ød	ℓ	Lf	b	a	lb	Air hole	Insert
TPA15R200U0075A04	0.590	2.000	4	1.625	0.750	0.750	1.570	0.197	0.315	0.600	with	TOMT15...
TPA15R250U0075A05	0.590	2.500	5	2.125	0.750	0.750	1.570	0.197	0.315	0.900	with	TOMT15...
TPA15R300U0100A06	0.590	3.000	6	2.250	1.000	1.024	1.750	0.236	0.374	1.900	with	TOMT15...
TPA15R400U0150A07N	0.590	4.000	7	3.000	1.500	1.181	2.000	0.394	0.626	1.270	without	TOMT15...
TPA15R500U0150A08N	0.590	5.000	8	4.000	1.500	1.175	2.000	0.394	0.626	2.800	without	TOMT15...
TPA15R600U0200A10N	0.590	6.000	10	4.750	2.000	1.220	2.000	0.433	0.748	10.520	without	TOMT15...

SPARE PARTS

Designation	Clamping screw	Grip	Lubricant	Torx bit	Center bolt (Optional parts)
TPA15R200U0075A04	TS45120I	H-TB2W	M-1000	BT20S	(TCS9.525-35-I)
TPA15R250U0075A05	TS45120I	H-TB2W	M-1000	BT20S	(C0.375X1.125H)
TPA15R300U0100A06	TS45120I	H-TB2W	M-1000	BT20S	(C0.500X1.375H)
TPA15R400U0150A07N	TS45120I	H-TB2W	M-1000	BT20S	-
TPA15R500U0150A08N	TS45120I	H-TB2W	M-1000	BT20M	-
TPA15R600U0200A10N	TS45120I	H-TB2W	M-1000	BT20M	-

Reference pages

Inserts → **D044**, Standard cutting conditions → **D045**

TUNG-TRI

EPA15

High precision square shoulder milling endmills with triangular inserts

A.R. = +12°~ +13.5°, R.R. = -6°~ -3.5°

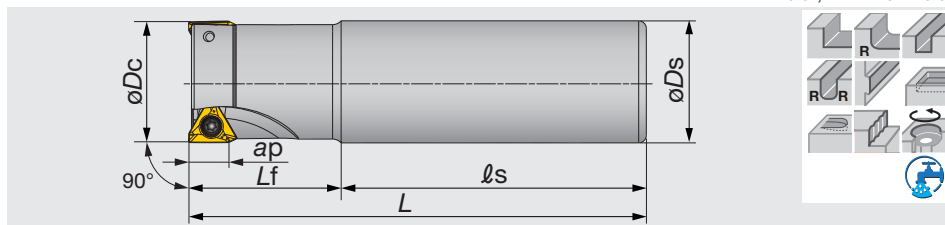

Shoulder Milling

Inch	Max. ap	ϕD_c	z	ϕD_s	l_s	L_f	L	lb	Air hole	Insert
EPA15R150U0125W02L	0.590	1.500	2	1.25	2.25	4.25	6.5	2.07	with	TOMT15...
EPA15R150U0125W03N	0.590	1.500	3	1.25	2.25	2.25	4.5	1.48	without	TOMT15...
EPA15R200U0125W04N	0.590	2.000	4	1.25	2.25	2.25	4.5	1.74	without	TOMT15...

SPARE PARTS

Designation	Clamping screw	Grip	Lubricant	Torx bit
EPA15...	TS45120I	H-TB2W	M-1000	BT20S

TUNG-TRI

TLA15-M

Extended Flute square shoulder mills for roughing with triangular inserts

A.R. = +12°~ +13.5°, R.R. = -6°~ -3.5°

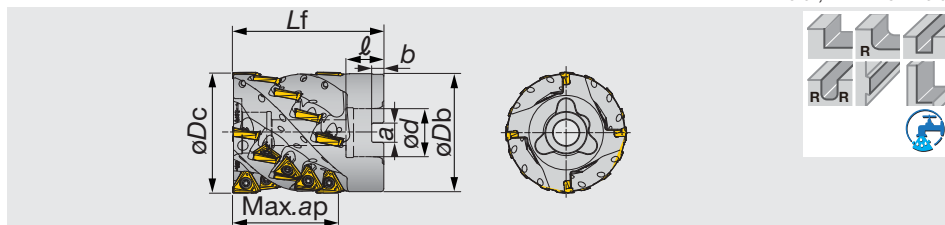

Inch	Max. ap	ϕD_c	Z eff	z	ϕD_b	ϕd	l	L_f	b	a	lb	Air hole	Insert
TLA15R300L275U0125A04M	2.756	3.000	4	20	2.937	1.250	1.260	3.940	0.315	0.500	4.560	with	TOMT15...
TLA15R400L326U0150A05M	3.268	4.000	5	20	3.875	1.500	1.260	4.375	0.394	0.626	10.00	with	TOMT15...

SPARE PARTS

Designation	Clamping screw	Grip	Torx bit	Lubricant	Center bolt
TLA15R300L275U0125A04M	TS45120I	H-TB2W	BT20S	M-1000	SD10-54
TLA15R400L326U0150A05M	TS45120I	H-TB2W	BT20S	M-1000	SD12-B9

Reference pages

Inserts → D044, Standard cutting conditions → D045

A.R. = +12°~ +13.5°, R.R. = -6°~ -3.5°

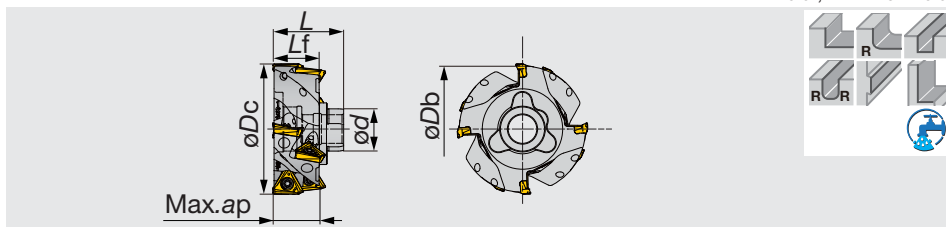

Inch	Max. ap	øDc	Z eff	z	øDb	ød	L	Lf	lb	Air hole	Insert
TLA15R300L110A04S	1.102	3.000	4	8	2.898	1.024	1.703	1.102	1.240	with	TOMT15...
TLA15R400L110A05S	1.102	4.000	5	10	3.882	1.299	1.814	1.102	2.440	with	TOMT15...

SPARE PARTS

Designation	Clamping screw	Grip	Lubricant	Torx bit
TLA15...	TS45120I	H-TB2W	M-1000	BT20S

CENTER BOLT

*Optional parts

No. of sub-units	Unit 1	Unit 2
TLA15R300..	SD10-04	SD10-B3
TLA15R400..	SD12-C1	SD12-B8

INSERT

TOMT-MJ

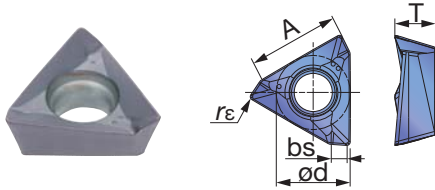

TOMT-NMJ

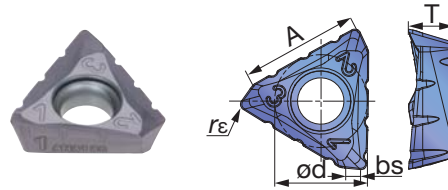

TOGT-AJ

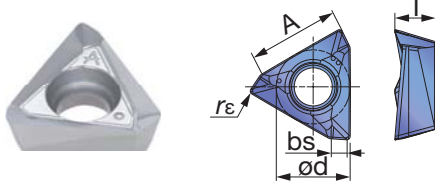

Shoulder Milling

P	Steel	☆	★																
M	Stainless		★																
K	Cast iron	★		★															
N	Non-ferrous					★													
S	Superalloys	★	☆																
H	Hard materials																		

★ : First choice
☆ : Second choice

Designation	rε	Max. ap	Coated			Un-coated	A	ød	T	bs
			AH120	AH3135	T1215	KS05F				
TOMT060302PDER-MJ	0.008	0.236	●	●			0.244	0.220	0.126	0.055
TOMT060304PDER-MJ	0.016	0.236	●	●			0.244	0.220	0.126	0.047
TOMT060308PDER-MJ	0.031	0.236	●	●	●		0.244	0.220	0.126	0.031
TOMT100404PDER-MJ	0.016	0.394	●	●			0.413	0.339	0.185	0.059
TOMT100408PDER-MJ	0.031	0.394	●	●	●		0.413	0.339	0.185	0.043
TOMT100416PDER-MJ	0.063	0.394	●	●			0.413	0.339	0.185	0.008
TOMT150604PDER-MJ	0.016	0.590	●	●			0.618	0.500	0.236	0.087
TOMT150608PDER-MJ	0.031	0.590	●	●	●		0.618	0.500	0.236	0.075
TOMT150616PDER-MJ	0.063	0.590	●	●			0.618	0.500	0.236	0.043
TOMT150620PDER-MJ	0.079	0.590	●	●			0.618	0.500	0.236	0.028
TOMT150608PDER-NMJ	0.031	0.590	●	●			0.618	0.500	0.236	0.075
TOGT100404PDFR-AJ	0.016	0.394				●	0.413	0.339	0.185	0.059
TOGT100408PDFR-AJ	0.031	0.394				●	0.413	0.339	0.185	0.043
TOGT150604PDFR-AJ	0.016	0.590				●	0.618	0.500	0.236	0.087
TOGT150608PDFR-AJ	0.031	0.590				●	0.618	0.500	0.236	0.075

● : Line up

Caution for using NMJ chipbreaker



Insert with NMJ chipbreaker has a number marked on each corner.

DO NOT place the corners with the same number in adjacent flute as the cutter may be damaged.

For example, if you place the corner #1 in one flute, be sure to use #2 or #3 (and avoid #1) in the next one.

Item: TOMT150608PDER-NMJ

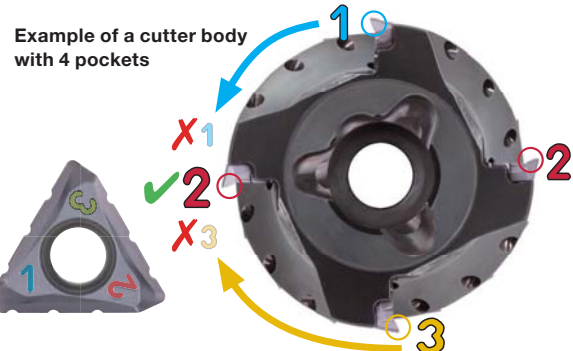

STANDARD CUTTING CONDITIONS

TPA/EPA

ISO	Workpiece materials	Hardness	Grades	Cutting speed: Vc (sfm)			Feed per tooth: fz (ipt)		
				T/EPA06	T/EPA10	T/EPA15	T/EPA06	T/EPA10	T/EPA15
P	Low carbon steels (1015, etc.)	- 200	AH3135	330 - 720	330 - 820	330 - 820	0.002 - 0.006	0.003 - 0.008	0.003 - 0.01
	High carbon steels (1045, etc.)	200 - 300	AH3135	330 - 560	330 - 660	330 - 750	0.002 - 0.005	0.003 - 0.006	0.003 - 0.008
	Alloyed steels (4140, etc.)	200 - 300	AH3135	330 - 560	330 - 660	330 - 750	0.002 - 0.005	0.003 - 0.006	0.003 - 0.008
	Tool steels (H13, etc.)	30 - 40 HRC	AH3135	330 - 390	330 - 500	330 - 600	0.002 - 0.005	0.003 - 0.006	0.003 - 0.008
M	Stainless steels (304, etc.)	-	AH3135	260 - 490	260 - 660	330 - 660	0.002 - 0.006	0.003 - 0.006	0.003 - 0.008
K	Gray cast irons (No.250B, etc.)	150 - 250	AH120	330 - 660	330 - 820	330 - 820	0.002 - 0.006	0.005 - 0.01	0.003 - 0.01
	Ductile cast irons (65-45-12, etc.)	150 - 250	AH120	260 - 490	260 - 660	260 - 660	0.002 - 0.006	0.005 - 0.01	0.003 - 0.01
N	Aluminum alloy (Si < 13%)	-	KS05F	-	980 - 3280	-	-	0.003 - 0.009	-
	Aluminum alloy (Si ≥ 13%)	-	KS05F	-	330 - 660	-	-	0.003 - 0.009	-
S	Titanium alloy (Ti-6Al-4V, etc.)	-	AH120	65 - 165	60 - 200	60 - 200	0.002 - 0.004	0.003 - 0.006	0.003 - 0.007
	Heat-resistance alloy (Inconel 718, etc.)	-	AH120	65 - 115	60 - 130	60 - 130	0.001 - 0.003	0.003 - 0.005	0.003 - 0.006

- To remove excessive chip accumulation use an air blast.
- When cutting an interrupted surface or a casted skin, the feed per tooth (fz) should be reduced to the lower recommended value shown in the above table.
- Cutting conditions are limited by machine power, workpiece rigidity, and spindle output.

- When the cutting width, depth, or overhang length is large, set Vc and fz to the lower recommended values and check the machine power and vibration.
- When you use the NMJ chipbreaker, please set up the feed less than 0.006 ipt.



Shoulder Milling

TLA (Roughing type)

ISO	Workpiece material	Hardness	Grade	Cutting speed: Vc (sfm)		Feed per tooth: fz (ipt)	
				TLA10	TLA15	TLA10	TLA15
P	Low carbon steel 1015, etc.	- 200 HB	AH3135	330 - 820	330 - 820	0.003 - 0.007	0.003 - 0.009
	High carbon steel 1045, etc.	200 - 300 HB	AH3135	330 - 660	330 - 890	0.003 - 0.006	0.003 - 0.007
	Alloy steel 4140, etc.	200 - 300 HB	AH3135	330 - 490	330 - 590	0.003 - 0.006	0.003 - 0.007
M	Stainless steel 304, etc.	-	AH3135	260 - 660	300 - 660	0.003 - 0.006	0.003 - 0.007
K	Grey cast iron No.250B, etc.	150 - 250 HB	AH120 T1215	330 - 820 490 - 820	460 - 820 460 - 820	0.004 - 0.007	0.003 - 0.009
	Ductile cast iron 65-45-12, etc.	150 - 250 HB	AH120 T1215	260 - 660 490 - 820	360 - 660 460 - 820	0.004 - 0.007	0.003 - 0.009
N	Aluminum alloy (Si < 13%)	-	KS05F	980 - 3280	-	0.003 - 0.009	-
	Aluminum alloy (Si ≥ 13%)	-	KS05F	330 - 660	-	0.003 - 0.009	-
S	Titanium alloys Ti-6Al-4V, etc.	-	AH120	66 - 197	66 - 197	0.003 - 0.006	0.002 - 0.006
	Heat-resistant alloys Inconel 718, etc.	-	AH120	66 - 130	72 - 130	0.002 - 0.005	0.002 - 0.005

Note: When you use the NMJ chipbreaker, please set up the feed less than 0.006".

APPLICATION RANGE

Shoulder Milling

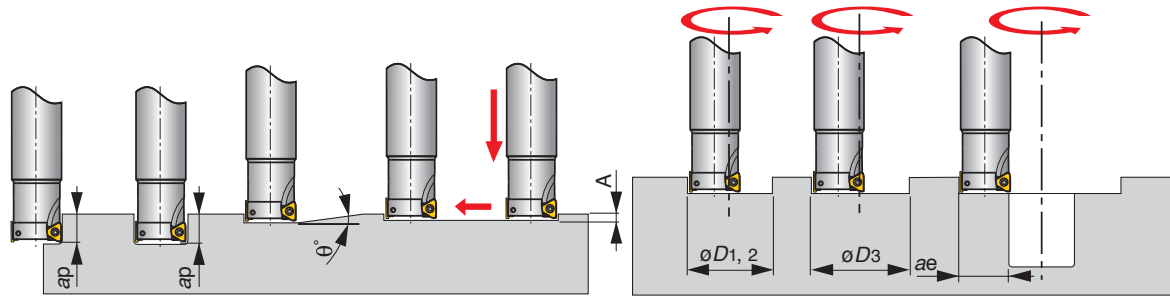

Inch	ϕD_c	Max. depth of cut (in) ap	Max. ramping angle θ	Max. plunging (in) A	Min. machining (in) ϕD_1	Max. machining (in) ϕD_2 ϕD_3		Max. cutting width in enlarging (in) ae
EPA06R050U...	0.500	0.236	5°	0.024	0.748	0.984	0.882	0.480
EPA06R063U...	0.625	0.236	4°	0.024	0.984	1.234	1.132	0.605
EPA06R075U...	0.750	0.236	3°	0.024	1.240	1.484	1.382	0.730
EPA06R100U...	1.000	0.236	2°	0.024	1.752	1.984	1.882	0.980
TPA06R200U...	2.000	0.236	0.7°	0.024	3.740	3.984	3.882	1.980
EPA10R100U...	1.000	0.394	2°	0.024	1.689	1.984	1.882	0.980
EPA10R125U...	1.250	0.394	2°	0.024	2.189	2.484	2.382	1.230
EPA10R150U...	1.500	0.394	1.4°	0.024	2.689	2.984	2.882	1.480
TPA10R200U...	2.000	0.394	0.8°	0.024	3.689	3.984	3.882	1.980
TPA10R250U...	2.500	0.394	0.7°	0.024	4.689	4.984	4.882	2.480
TPA10R300U...	3.000	0.394	0.6°	0.024	5.689	5.984	5.882	2.980
TPA10R400U...	4.000	0.394	0.5°	0.024	7.689	7.984	7.882	3.980
EPA15R150U...	1.500	0.590	2.3°	0.031	2.547	2.969	2.823	1.461
E/TPA15R200U...	2.000	0.590	1.7°	0.031	3.547	3.969	3.823	1.961
TPA15R250U...	2.500	0.590	1.4°	0.031	4.547	4.969	4.823	2.461
TPA15R300U...	3.000	0.590	1°	0.031	5.547	5.969	5.823	2.961
TPA15R400U...	4.000	0.590	0.8°	0.031	7.547	7.969	7.823	3.961
TPA15R500U...	5.000	0.590	0.6°	0.031	9.547	9.969	9.823	4.961
TPA15R600U...	6.000	0.590	0.5°	0.031	11.547	11.969	11.823	5.961

*Flat bottom hole

Notes: Corner r_E for dimensions of ϕD_3 : $r_E = 0.016''$ for T/EPA06 / 10 and $r_E = 0.031''$ for T/EPA15.

TUNG^{TR}SHRED

TPTC16

Square shoulder milling cutters with shred insert

A.R. = +5.5°~ +6.5°, R.R. = -11.5°~ -11.3°

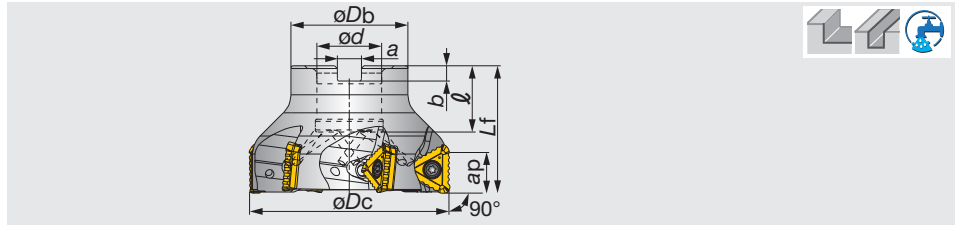

Inch	Max. ap	ϕDc	z	ϕDb	L_f	ϕd	ℓ	a	b	lb	Insert
TPTC16U2.00B0.75R04	0.630	2.000	4	1.625	1.570	0.750	0.750	0.315	0.197	0.710	TC*T16...
TPTC16U2.50B0.75R05	0.630	2.500	5	2.125	1.570	0.750	0.750	0.315	0.197	1.260	TC*T16...
TPTC16U3.00B1.00R06	0.630	3.000	6	2.250	1.752	1.000	1.024	0.374	0.236	1.810	TC*T16...
TPTC16U4.00B1.50R07	0.630	4.000	7	3.000	2.000	1.500	1.193	0.626	0.394	3.170	TC*T16...

SPARE PARTS



Designation	Clamping screw	Grip	Lubricant	Torx bit	Center bolt (Optional parts)
TPTC16U2.00B0.75R04	TS 40B100I	H-TB2W	M-1000	BT15S	(TCS9.525-35-I)
TPTC16U2.50B0.75R05	TS 40B100I	H-TB2W	M-1000	BT15S	(C0.375X1.125H)
TPTC16U3.00B1.00R06	TS 40B100I	H-TB2W	M-1000	BT15S	(C0.500X1.375H)
TPTC16U4.00B1.50R07	TS 40B100I	H-TB2W	M-1000	BT15S	-

Shoulder Milling

TUNG^{TR}SHRED

EPTC16

Square Shoulder milling cutters with shred insert

A.R. = +5.5°~ +6.5°, R.R. = -11.5°~ -11.3°

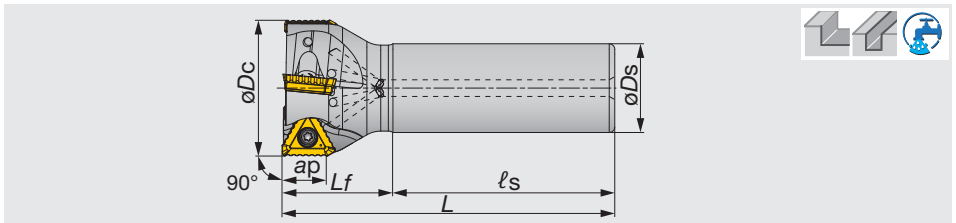

Inch	Max. ap	ϕDc	z	ϕDs	ℓ_s	L_f	L	lb	Insert
EPTC16U2.00W1.25R04	0.630	2.000	4	1.250	2.250	2.250	4.500	1.700	TC*T16**

SPARE PARTS



Designation	Clamping screw	Grip	Lubricant	Torx bit
EPTC16...	TS 40B100I	H-TB2W	M-1000	BT15S

Reference pages

Inserts → D048, Standard cutting conditions → D049

TUNG T^{RI} SHRED

LPTC16

Square shoulder milling cutters for roughing with shred insert

A.R. = +5.5°~ +6.5°, R.R. = -11.5°~ -11.3°

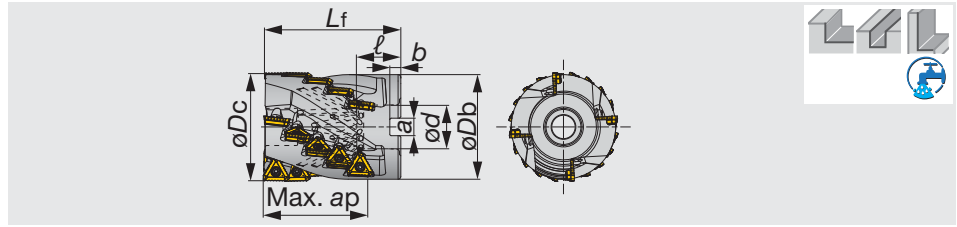

Shoulder Milling

Inch	Max. ap	øDc	Z eff	z	øDb	Lf	ød	ℓ	a	b	lb	Insert
LPTC16U2.50B1.00L2.4R03	2.402	2.500	3	12	2.350	3.350	1.000	1.024	0.374	0.236	2.820	TC*T16...
LPTC16U3.00B1.25L3.0R04	2.992	3.000	4	20	2.839	4.000	1.250	1.260	1.260	0.315	4.670	TC*T16...

SPARE PARTS

Designation	Clamping screw	Grip	Lubricant	Center bolt	Torx bit
LPTC16U2.50B1.00L2.4R03	TS 40B100I	H-TB2W	M-1000	SD-08-C8	BT15S
LPTC16U3.00B1.25L3.0R04	TS 40B100I	H-TB2W	M-1000	SD10-54	BT15S

INSERT

TCGT-MJ

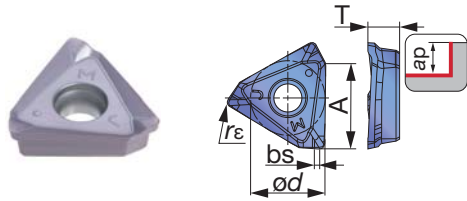

TCMT-NMJ

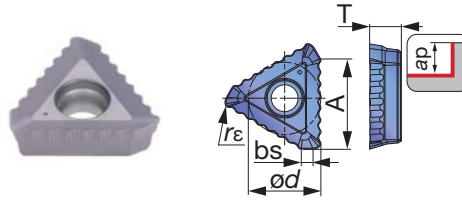

P	Steel	☆	★							
M	Stainless		★							
K	Cast iron	★								
N	Non-ferrous									
S	Superalloys	★	☆							
H	Hard materials									

★ : First choice
☆ : Second choice

Designation	rε	Max. ap	Coated		A	ød	T	bs
			AH120	AH3135				
TCGT160608PDER-MJ	0.031	0.630	●	●	0.630	0.539	0.228	0.039
TCMT160620PDER-NMJ	0.079	0.630	●	●	0.630	0.524	0.228	0.079

Note: When using the NMJ chipbreaker no specific insert orientation is necessary.

●: Line up

Reference pages

Standard cutting conditions → D049

D048 www.tungaloyamerica.com

STANDARD CUTTING CONDITIONS

ISO	Workpiece materials	Hardness	Priority	Grades	Chip-breaker	Cutting speed Vc (sfm)	Feed per tooth fz (ipt)
P	Low carbon steels (1015, 1020, etc.)	- 300 HB	First choice	AH3135	NMJ*	330 - 830	0.003 - 0.006
		- 300 HB	For finishing	AH3135	MJ	330 - 830	0.003 - 0.008
	Carbon steels, Alloy steels (1055, 4140, etc.)	- 300 HB	First choice	AH3135	NMJ*	330 - 760	0.003 - 0.006
		- 300 HB	For finishing	AH3135	MJ	330 - 760	0.003 - 0.008
	Prehardened steel (NAK80, PX5, etc.)	30 - 40 HRC	First choice	AH3135	NMJ*	330 - 590	0.003 - 0.006
		30 - 40 HRC	For finishing	AH3135	MJ	330 - 590	0.003 - 0.008
M	Stainless steels (304, 316, etc.)	-	First choice	AH3135	NMJ*	300 - 660	0.003 - 0.006
		-	For finishing	AH3135	MJ	300 - 660	0.003 - 0.008
K	Grey cast irons (No.25, No.30, etc.)	150 - 250 HB	First choice	AH120	NMJ*	460 - 830	0.003 - 0.006
		150 - 250 HB	For finishing	AH120	MJ	460 - 830	0.003 - 0.010
	Ductile cast irons (60-40-18, 80-55-06, etc.)	150 - 250 HB	First choice	AH120	NMJ*	460 - 830	0.003 - 0.006
		150 - 250 HB	For finishing	AH120	MJ	460 - 830	0.003 - 0.010
S	Titanium alloys (Ti-6Al-4V, etc.)	-	First choice	AH120	NMJ*	70 - 200	0.003 - 0.006
		-	For finishing	AH120	MJ	70 - 200	0.003 - 0.007
	Heat-resistant alloys (Inconel718, etc.)	-	First choice	AH120	NMJ*	70 - 130	0.003 - 0.005
		-	For finishing	AH120	MJ	70 - 130	0.003 - 0.006

* When you use the NMJ chipbreaker, please set up the feed less than 0.006 ipt.



Shoulder Milling

Square shoulder milling endmills in small diameter

A.R. = +6.0°~ +7.6°, R.R. = -37.1°~ -32.4°

Shoulder Milling

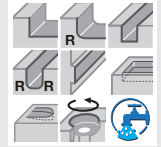
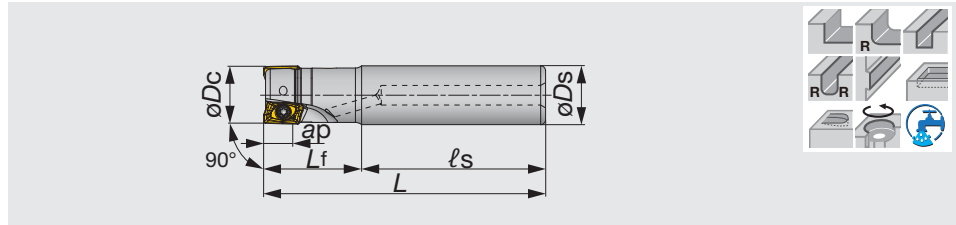

Inch	Max. ap	ϕD_c	z	ϕD_s	l_s	L_f	L	lb	Insert
EPAV06U0.31C0.37R01	0.236	0.313	1	0.375	2.463	0.787	3.250	0.090	AVGT06**
EPAV06U0.37C0.37R01	0.236	0.375	1	0.375	2.463	0.787	3.250	0.090	AVGT06**
EPAV06U0.37C0.37R01L	0.236	0.375	1	0.375	2.622	1.378	4.000	0.110	AVGT06**
EPAV06U0.50C0.50R02	0.236	0.500	2	0.500	2.463	0.787	3.250	0.150	AVGT06**
EPAV06U0.50C0.50R03	0.236	0.500	3	0.500	2.463	0.787	3.250	0.150	AVGT06**
EPAV06U0.50C0.50R02L	0.236	0.500	2	0.500	3.388	1.362	4.750	0.220	AVGT06**
EPAV06U0.62C0.62R03	0.236	0.625	3	0.625	2.713	0.787	3.500	0.260	AVGT06**
EPAV06U0.62C0.62R04	0.236	0.625	4	0.625	2.713	0.787	3.500	0.260	AVGT06**
EPAV06U0.62C0.62R03L	0.236	0.625	3	0.625	4.122	1.378	5.500	0.420	AVGT06**

SPARE PARTS

Designation	Clamping screw	Lubricant	Wrench
EPAV06...	CSPB-2H	M-1000	IP-6DB

Square shoulder milling endmills in small diameter; Modular head with TungFlex connection

A.R. = +6.0°~ +7.6°, R.R. = -37.1°~ -32.4°

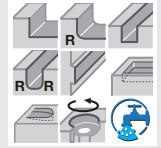
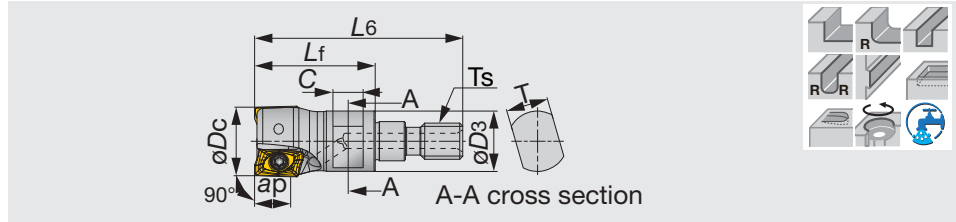

Metric	Max. ap	ϕD_c	z	L_6	L_f	C	T	ϕD_3	T_s	lb	Insert
HPAV06M010M06R02	6	10	2	34.5	20	5	7	9.5	M6	0.010	AVGT06...
HPAV06M012M06R02	6	12	2	34.5	20	5	7	10	M6	0.010	AVGT06...
HPAV06M012M06R03	6	12	3	34.5	20	5	7	10	M6	0.010	AVGT06...
HPAV06M016M08R03	6	16	3	42	25	8	10	13	M8	0.030	AVGT06...
HPAV06M016M08R04	6	16	4	42	25	8	10	13	M8	0.030	AVGT06...

• See page D147 for TungFlex modular shank.

SPARE PARTS

Designation	Clamping screw	Lubricant	Wrench
HPAV06M...	CSPB-2H	M-1000	IP-6DB

Reference pages

Inserts, Standard cutting conditions → D051

INSERT

AVGT-MJ

AVGT-AJ

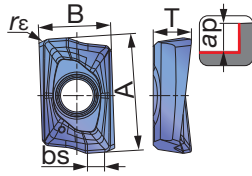

P Steel	★	★																
M Stainless			★															
K Cast iron	★																	
N Non-ferrous							★											
S Superalloys	★	☆																
H Hard materials	★																	

★ : First choice
☆ : Second choice

Designation	rε	Max. ap	Coated		Un-coated	A	B	T	bs
			AH120	AH3135	KS05F				
AVGT060302PBER-MJ	0.008	0.236	●	●		0.315	0.197	0.106	0.059
AVGT060304PBER-MJ	0.016	0.236	●	●		0.315	0.197	0.106	0.051
AVGT060308PBER-MJ	0.031	0.236	●	●		0.315	0.197	0.102	0.035
AVGT060302PBFR-AJ	0.008	0.236			●	0.315	0.197	0.106	0.059
AVGT060304PBFR-AJ	0.016	0.236			●	0.315	0.197	0.106	0.051
AVGT060308PBFR-AJ	0.031	0.236			●	0.315	0.197	0.102	0.035

● : Line up



Shoulder Milling

STANDARD CUTTING CONDITIONS

ISO	Workpiece materials	Hardness	Priority	Grades	Chip-breaker	Cutting speed Vc (sfm)	Feed per tooth fz (ipt)	
P	Low carbon steel (1018, 1020, 1026, etc.)	- 300 HB	First choice	AH3135	MJ	755 - 1400	0.003 - 0.005	
	Carbon steel and alloy steel (1055, 4140, etc.)	- 300 HB	First choice	AH3135	MJ	490 - 1150	0.003 - 0.005	
	Prehardened steel (NAK80, PX5, etc.)	30 - 40 HRC	First choice	AH120	MJ	650 - 1020	0.003 - 0.005	
M	Stainless steel (304SS, 316SS, 17-4 PH, etc.)	-	First choice	AH3135	MJ	650 - 1020	0.002 - 0.004	
K	Gray cast iron (Class 25, Class 30, etc.)	150 - 250 HB	First choice	AH120	MJ	650 - 1080	0.003 - 0.005	
	Ductile cast iron (60-40-18, 60-55-06, etc.)	150 - 250 HB	First choice	AH120	MJ	490 - 790	0.003 - 0.005	
N	Aluminum alloys (Si < 13%)	-	First choice	KS05F	AJ	2130 - 3280	0.003 - 0.005	
S	Titanium alloys (Ti-6Al-4V, etc.)	-	First choice	AH120	MJ	150 - 230	0.002 - 0.0035	
	Superalloys (Inconel 718, etc.)	-	First choice	AH120	MJ	100 - 160	0.002 - 0.003	
H	Hardened steel	(H13, etc.)	40 - 50 HRC	First choice	AH120	MJ	150 - 230	0.002 - 0.003
		(D2, etc.)	50 - 60 HRC	First choice	AH120	MJ	150 - 210	0.0015 - 0.0025

APPLICATION RANGE

Shoulder Milling

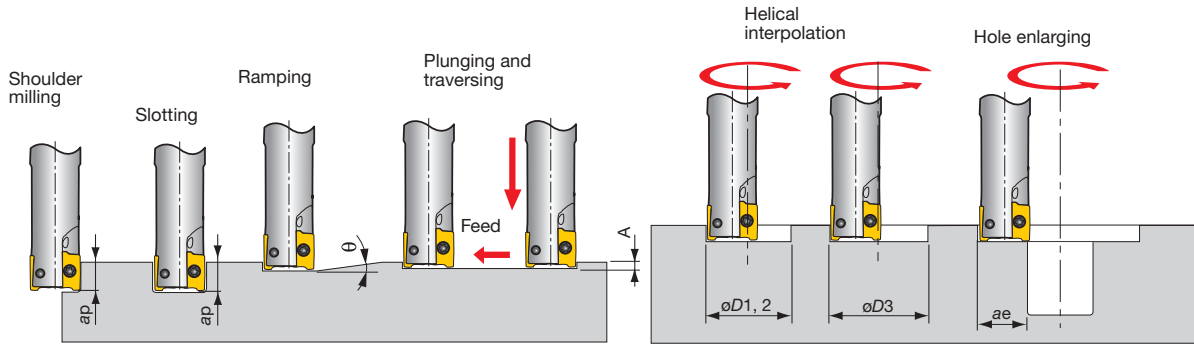

Inch	Tool dia. ϕDc	Max. depth of cut ap	Max. ramping angle θ	Max. plunging depth A	Min. machining $\phi D1$	Max. machining $\phi D2$ $\phi D3^*$		Max. cutting width in enlarging ae
EPAV06U0.31...	0.313	0.236	-	-	-	-	-	-
EPAV06U0.37...	0.375	0.236	3°	0.012	0.591	0.748	0.709	0.374
EPAV06U0.50...	0.500	0.236	3°	0.020	0.709	0.906	0.866	0.453
EPAV06U0.62...	0.625	0.236	2.5°	0.024	0.984	1.220	1.181	0.610

*Flat bottom hole

MEMO



Shoulder Milling

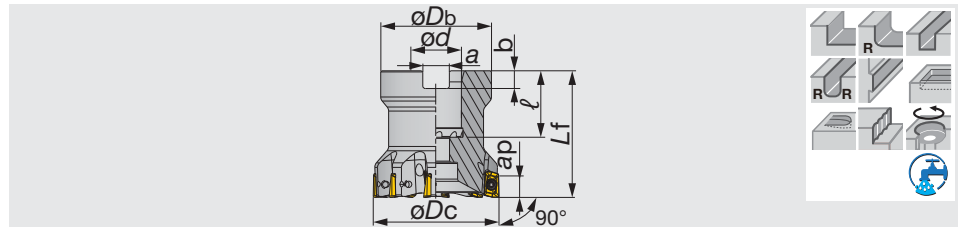

Inch	ϕD_c	z	ϕD_b	L_f	ϕd	ℓ	a	b	lb	Air hole	Insert
TPO07R200U0075A12	2.000	12	1.693	1.575	0.750	0.789	0.315	0.197	0.660	with	AO*T0702...

SPARE PARTS

Designation	Clamping screw	Center bolt	Wrench
TPO07R200U0075A12	CSTB-2.5L046	C0.375X1.125H	T-7DB

Shoulder Milling

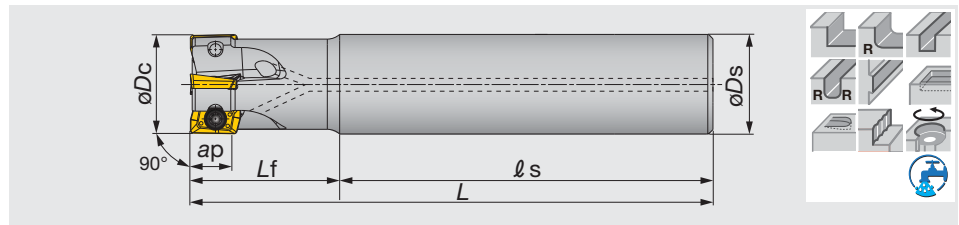

Inch	ϕD_c	z	ϕD_s	ℓ_s	L_f	L	lb	Air hole	Insert
EPO07R050U0050-02	0.500	2	0.500	2.250	0.750	3.000	0.140	with	AO*T0702...
EPO07R063U0063-04	0.625	4	0.625	2.563	0.937	3.500	0.250	with	AO*T0702...
EPO07R075U0075-05	0.750	5	0.750	2.875	1.125	4.000	0.410	with	AO*T0702...
EPO07R100U0075-03	1.000	3	0.750	2.000	1.500	3.500	0.400	with	AO*T0702...
EPO07R100U0100W07	1.000	7	1.000	2.281	1.500	3.781	0.680	with	AO*T0702...

*The ϕD_c in the above table shows the diameter when MJ and AJ chipbreakers are used. When HJ chipbreaker is used, the tool diameter is equal to the above shown $\phi D_c + 0.024$ ".

**The L_f and L in the above table show the lengths when MJ chipbreaker is used. When AJ chipbreaker is used, the lengths are equal to $L_f, L + 0.004$ ". When HJ chipbreaker is used, the lengths are equal to $L_f, L + 0.02$ ".

SPARE PARTS

Designation	Clamping screw	Wrench
EPO07R...	CSTB-2.5L046	T-7DB

Reference pages

Inserts → **D055**, Standard cutting conditions → **D056**

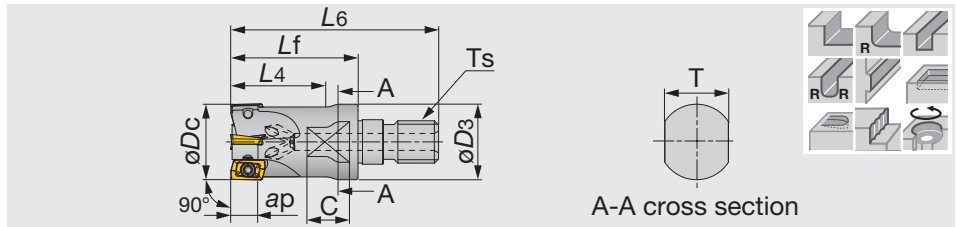

Metric	øDc	z	L6	Lf	L4	C	T	øD3	Ts	Kg	Air hole	Insert
HPO07R012MM06-02	12	2	39.5	25	-	5	7	9.8	M6	0.01	with	AO*T0702...
HPO07R012MM08-02	12	2	42	25	20	8	10	12.8	M8	0.02	with	AO*T0702...
HPO07R016MM08-04	16	4	42	25	-	8	10	12.8	M8	0.03	with	AO*T0702...
HPO07R016MM10-04	16	4	49	30	20	10	15	17.8	M10	0.05	with	AO*T0702...
HPO07R020MM10-05	20	5	49	30	-	10	15	17.8	M10	0.06	with	AO*T0702...
HPO07R025MM12-07	25	7	57	35	-	10	17	20.8	M12	0.1	with	AO*T0702...

SPARE PARTS

Designation	①Clamping screw	Lubricant	Wrench
HPO07R012MM0*-02	SR-10503833-S	M-1000	T-7DB
HPO07R016 - 025...	CSTB-2.5L046	M-1000	T-7DB

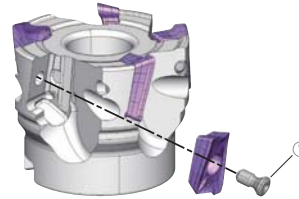

Shoulder Milling

INSERT

AOMT07-MJ

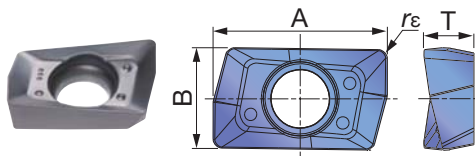

AOMT07-HJ

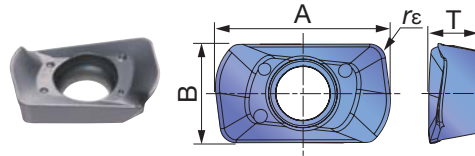

AOGT07-AJ

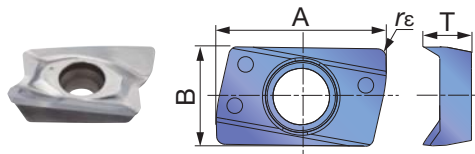

	P Steel	M Stainless	K Cast iron	N Non-ferrous	S Superalloys	H Hard materials
	★	★ ☆	★	★	★	

★ : First choice
☆ : Second choice

Designation	rε	Max. ap	Coated		Un-coated	A	B	T
			AH140	AH725	KS15F			
AOMT070202PDPR-MJ	0.008	0.276	●	●		0.315	0.185	0.091
AOMT070204PDPR-MJ	0.016	0.276	●	●		0.315	0.185	0.091
AOMT070208PDPR-MJ	0.031	0.276	●	●		0.315	0.185	0.091
AOMT070216PDPR-MJ	0.063	0.276	●	●		0.315	0.185	0.091
AOMT070208PDPR-HJ	0.031	0.031	●	●		0.346	0.185	0.094
AOGT070204PDFR-AJ	0.016	0.252			●	0.319	0.185	0.091

● : Line up

Reference pages

Standard cutting conditions → D056

STANDARD CUTTING CONDITIONS

ISO	Workpiece material	Hardness HB	Grade	Cutting speed Vc (sfm)	Feed per tooth: fz (ipt)		
					MJ	HJ	AJ
P	Low carbon steel (1018, 1020, 1026, etc.)	< 200	AH725	300 - 660	0.002 - 0.004	0.015 - 0.035	-
	High carbon steel and alloy steel (1045, 4140, etc.)	200 - 300	AH725	300 - 500	0.002 - 0.004	0.015 - 0.035	-
	Tool steel (H13, etc.)	150 - 300	AH725	260 - 400	0.002 - 0.004	0.015 - 0.035	-
M	Stainless steel (304SS, 316SS, 17-4 PH, etc.)	-	AH140	300 - 500	0.002 - 0.004	0.015 - 0.035	-
K	Gray cast iron (Class 25, Class 30, etc.)	150 - 250	AH725	330 - 600	0.002 - 0.004	0.015 - 0.035	-
	Ductile cast iron (60-40-18, 60-55-06, etc.)	150 - 250	AH725	260 - 500	0.002 - 0.004	0.015 - 0.035	-
N	Aluminum alloys (Si < 13%)	-	KS15F	1000 - 3300	-	-	0.003 - 0.008
	Aluminum alloys (Si ≥ 13%)	-	KS15F	330 - 660	-	-	0.003 - 0.008
S	Titanium alloys (Ti-6Al-4V, etc.)	-	AH725	60 - 160	0.002 - 0.004	0.008 - 0.035	-
	Superalloys (Inconel 718, etc.)	-	AH725	60 - 115	0.002 - 0.003	0.008 - 0.024	-

- To remove excessive chip accumulation use an air blast.
- To avoid build up edge on the cutting edges (aluminum machining), use a water soluble coolant.
- When cutting an interrupted surface or a casted skin, the feed per tooth (fz) should be reduced to the lower recommended value shown in the above table.
- Cutting conditions are limited by machine power, workpiece rigidity, and spindle output. When the cutting width, depth, or overhang length is large, set Vc and fz to the lower recommended values and check the machine power and vibration.
- For application range see page D068.

CAUTIONARY POINTS WHEN USING HJ INSERTS

HJ type inserts are designed for high feed machining. Please note the following when using HJ inserts:

1. The shape of HJ insert differs from that of other inserts (MJ, AJ). However the same insert pocket can be used.
2. When using HJ inserts, all the inserts on the cutter body must be HJ type. Do not use other types of inserts (MJ and AJ types) with HJ inserts on the same cutter body.
3. When using CAD/CAM, please program it as a radius cutter. The table below shows the corner R when programming and the uncut area (t).
4. With HJ inserts, the tool diameter increases by 0.024" over the diameter ϕDc shown in the table.

TungRec 07 type HJ inserts Standard conditions

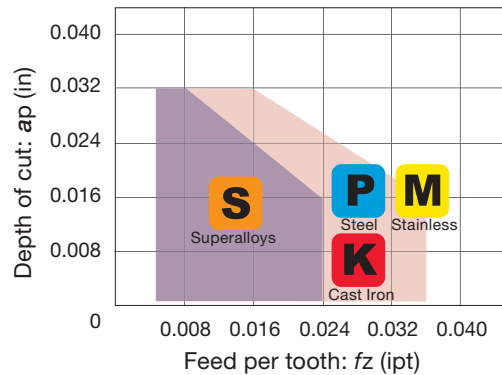

Max. depth of cut max ap (in)	Main cutting edge length W (in)	Corner R when programming	Amount left uncut t (in)
0.031	0.118	R 0.020"	0.016
		R 0.039"	0.012

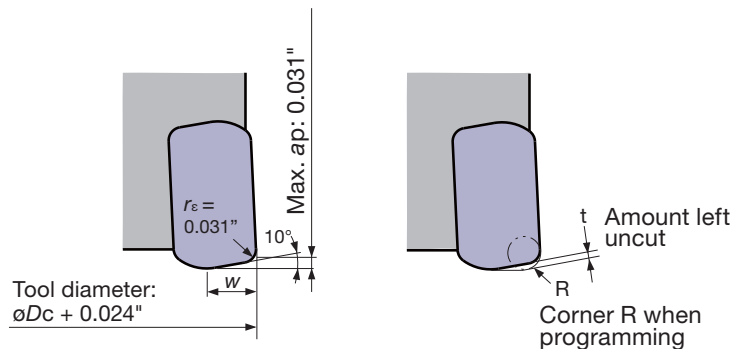

MEMO

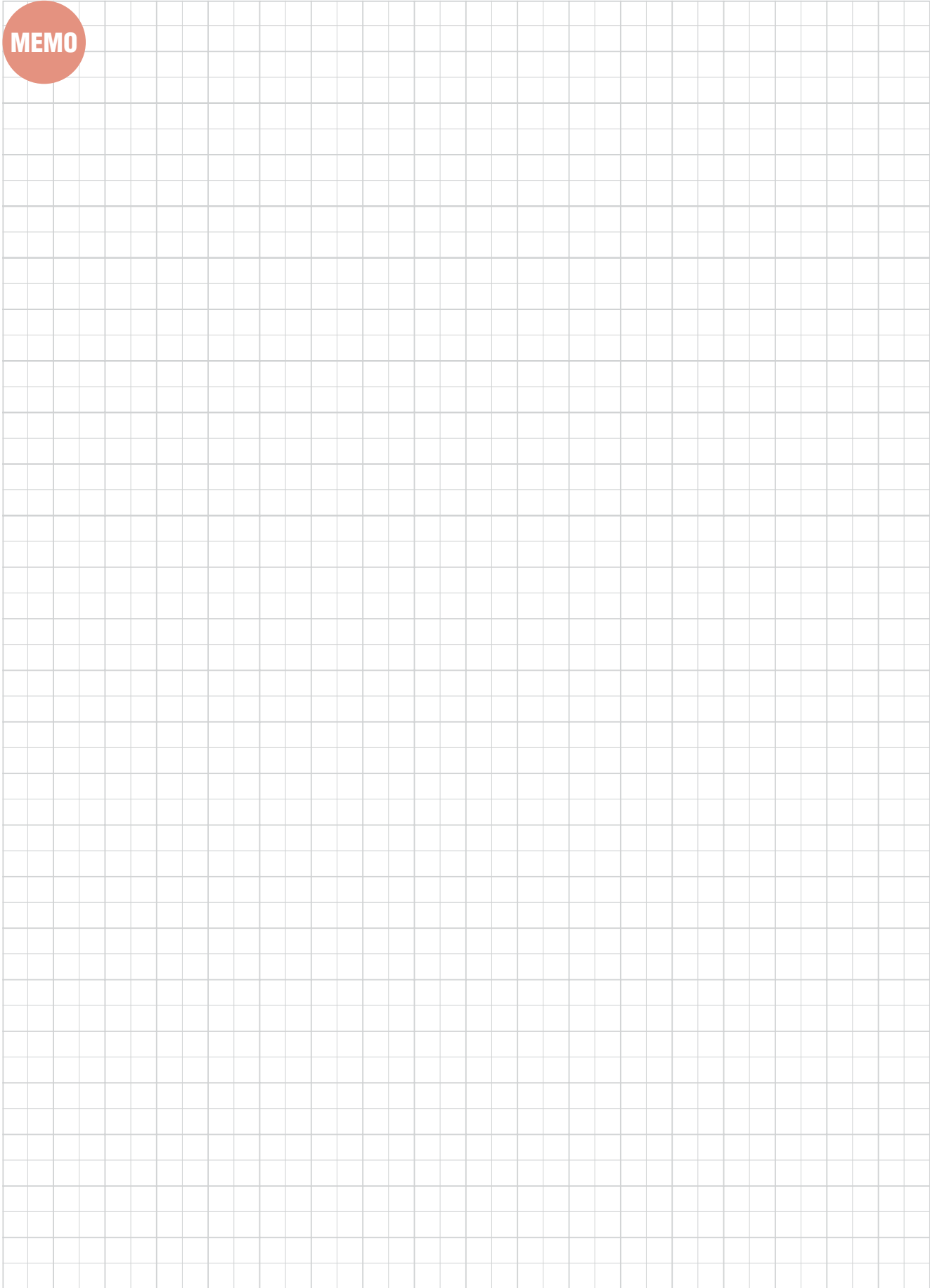

Shoulder Milling

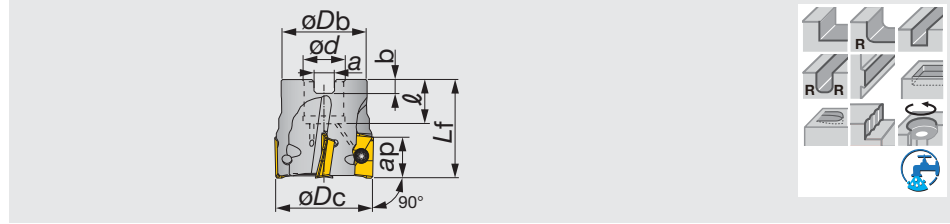

Inch	Max. ap	ϕDc	z	ϕDb	ϕd	ℓ	L_f	b	a	l_b	Air hole	Insert
TPS11200RBU	0.417	2.000	7	1.693	0.750	0.750	1.575	0.197	0.315	0.880	with	AS*T11T3...
TPS11300RBU	0.417	3.000	10	2.283	1.000	1.024	1.969	0.236	0.374	2.640	with	AS*T11T3...
TPS11400RBU	0.417	4.000	11	3.150	1.500	1.457	2.480	0.394	0.626	5.290	with	AS*T11T3...

SPARE PARTS

Designation	Clamping screw	Lubricant	Wrench	Center bolt (Optional parts)
TPS11200RBU	CSPB-2.5	M-1000	IP-8D	(C0.375x1.125H)
TPS11300RBU	CSPB-2.5	M-1000	IP-8D	(C0.500x1.375H)
TPS11400RBU	CSPB-2.5	M-1000	IP-8D	(TMBA-0.750H)

Shoulder Milling

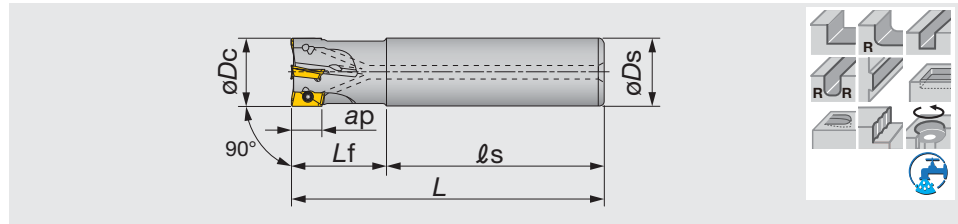

Inch	Max. ap	ϕDc	z	ϕDs	l_s	L_f	L	l_b	Air hole	Insert
EPS11050RLU	0.417	0.500	1	0.625	3.750	1.250	5.000	0.350	with	AS*T11T3...
EPS11050RSU	0.417	0.500	1	0.625	2.362	0.984	3.346	0.240	with	AS*T11T3...
EPS11062RLU	0.417	0.625	2	0.625	4.250	1.500	5.750	0.440	with	AS*T11T3...
EPS11062RSU	0.417	0.625	2	0.625	2.362	0.984	3.346	0.240	with	AS*T11T3...
EPS11075RLU	0.417	0.750	2	0.750	5.250	2.000	7.250	0.790	with	AS*T11T3...
EPS11075RSBU	0.417	0.750	3	0.750	2.362	1.181	3.543	0.370	with	AS*T11T3...
EPS11100RLU	0.417	1.000	2	1.000	5.750	2.750	8.500	1.700	with	AS*T11T3...
EPS11100RSBU	0.417	1.000	4	1.000	2.362	1.378	3.740	0.700	with	AS*T11T3...
EPS11100RSBU-3/4	0.417	1.000	4	0.750	2.360	1.378	3.738	0.480	with	AS*T11T3...
EPS11125RLU	0.417	1.250	2	1.250	7.000	3.000	10.000	3.190	with	AS*T11T3...
EPS11125RSBU	0.417	1.250	5	1.250	2.362	1.378	3.740	1.120	with	AS*T11T3...

SPARE PARTS

Designation	Clamping screw	Lubricant	Wrench
EPS11050RLU	CSPB-2.5	M-1000	IP-8D
EPS11050RSU	CSPB-2.5S	M-1000	IP-8D
EPS11062RLU	CSPB-2.5	M-1000	IP-8D
EPS11062RSU	CSPB-2.5S	M-1000	IP-8D
EPS11075RLU	CSPB-2.5	M-1000	IP-8D
EPS11075RSBU	CSPB-2.5S	M-1000	IP-8D
EPS11100RLU	CSPB-2.5	M-1000	IP-8D
EPS11100RSBU	CSPB-2.5	M-1000	IP-8D
EPS11100RSBU-3/4	CSPB-2.5	M-1000	IP-8D
EPS11125RLU	CSPB-2.5	M-1000	IP-8D
EPS11125RSBU	CSPB-2.5	M-1000	IP-8D

Reference pages

Inserts → D061, Standard cutting conditions → D062 - D063

TUNGREC

TLS11

Highly productive square shoulder mills for roughing with ASMT/ASGT11 inserts

A.R. = +8.7° ~ +18°, R.R. = -5.3° ~ -19.4°

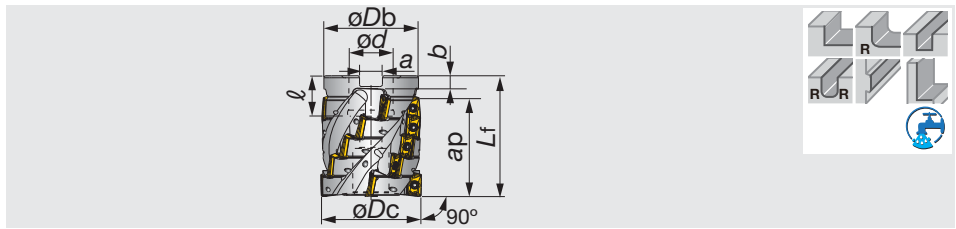

Inch	Max. ap	ϕD_c	Z eff	z	ϕD_b	L_f	ϕd	ℓ	a	b	l_b	Air hole	Insert
TLS11R200U0075A04	1.921	2.000	4	20	1.875	2.356	0.750	0.750	0.315	0.197	1.330	with	AS*T11T3...

SPARE PARTS

Designation	Clamping screw	Lubricant	Wrench	Center bolt
TLS11R200U0075A04	CSPB-2.5	M-1000	IP-8D	CM10X40H

Shoulder Milling

TUNGREC

ELS11

Highly productive endmills for roughing with ASMT/ASGT11 inserts

A.R. = +8.7° ~ +18°, R.R. = -5.3° ~ -19.4°

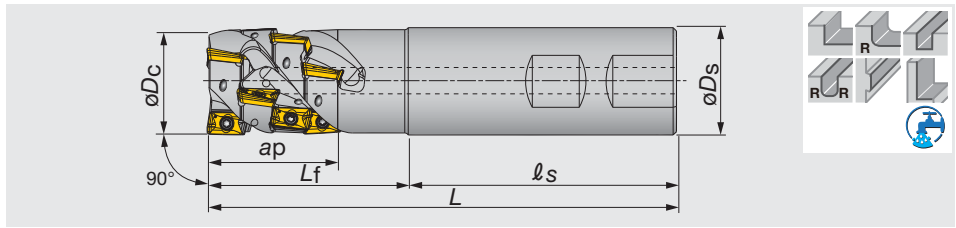

Inch	Max. ap	ϕD_c	Z eff	z	ϕD_s	l_s	L_f	L	l_b	Air hole	Insert
ELS11R100U0100W02	1.197	1.000	2	6	1.000	2.250	1.500	3.750	0.670	with	AS*T11T3...
ELS11R125U0125W03	1.535	1.250	3	12	1.250	2.250	2.250	4.500	1.330	with	AS*T11T3...
ELS11R150U0125W03	1.575	1.500	3	12	1.250	2.329	2.171	4.500	1.330	with	AS*T11T3...

SPARE PARTS

Designation	Clamping screw	Lubricant	Wrench
ELS11...	CSPB-2.5	M-1000	IP-8D

Reference pages

Inserts → **D061**, Standard cutting conditions → **D062 - D063**

A.R. = +8.7° ~ +18°, R.R. = -5.3° ~ -19.4°

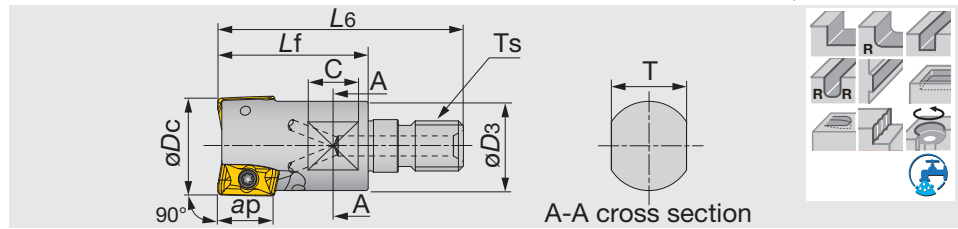

Shoulder Milling

Metric	Max. ap	øDc	z	L6	Lf	C	T	øD3	Ts	Kg	Air hole	Insert
HPO11R020MM10-02	10.6	20	2	49	30	10	15	17.8	M10	0.06	with	AS*T11T3...
HPO11R025MM12-03	10.6	25	3	57	35	10	17	20.8	M12	0.1	with	AS*T11T3...
HPO11R032MM16-03	10.6	32	3	63	40	12	22	28.8	M16	0.2	with	AS*T11T3...

SPARE PARTS



Designation	Clamping screw	Lubricant	Wrench
HPO11R020MM10-02	CSPB-2.5S	M-1000	IP-8D
HPO11R025, 032...	CSPB-2.5	M-1000	IP-8D

Reference pages

Inserts → **D061**, Standard cutting conditions → **D062 - D063**

INSERT

ASMT11-MJ

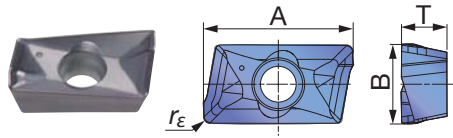

ASMT11-MS

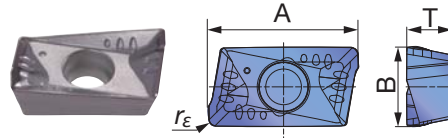

ASGT11-AJ

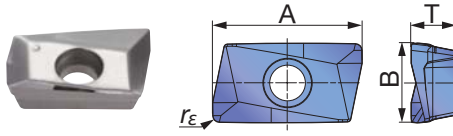

P	Steel			★			☆	☆					
M	Stainless	★											
K	Cast iron	★			☆	☆							
N	Non-ferrous							★		★			
S	Superalloys	★	★										
H	Hard materials												

★ : First choice
☆ : Second choice

Designation	rε	Max. ap	Coated							Cermet	Un-coated	A	B	T			
			AH120	AH130	AH140	AH725	T1115	T1215	T3130	DS1100	NS740				KS05F		
ASMT11T304PDPR-MJ	0.016	0.417	●	●		●	●		●						0.457	0.264	0.146
ASMT11T308PDPR-MJ	0.031	0.417	●	●	●	●	●	●	●						0.457	0.264	0.146
ASMT11T312PDPR-MJ	0.047	0.417	●	●		●			●						0.457	0.264	0.146
ASMT11T316PDPR-MJ	0.063	0.417	●	●		●			●						0.457	0.264	0.146
ASMT11T320PDPR-MJ	0.079	0.417	●	●											0.457	0.264	0.146
ASMT11T330PDPR-MJ	0.118	0.417	●	●											0.457	0.264	0.146
ASMT11T304PDPR-MS	0.016	0.417		●	●										0.457	0.264	0.146
ASGT11T304PDFR-AJ	0.016	0.417							●		●				0.457	0.264	0.146
ASGT11T308PDFR-AJ	0.031	0.417							●		●				0.457	0.264	0.146

● : Line up



Shoulder Milling

STANDARD CUTTING CONDITIONS

TPS11/EPS11/HPO11 type

Shoulder Milling

ISO	Workpiece material	Brinell hardness HB	Priority	Grade	Cutting speed: Vc (sfm)	Feed per tooth: fz (ipt)		
						MJ	MS	AJ
P	Low carbon steel (1018, 1020, 1026, etc.)	~ 200	First choice	AH725	330 - 820	0.004 - 0.008	-	-
		~ 200	For wear resistance	T3130	330 - 820	0.004 - 0.008	-	-
		~ 200	For surface appearance	NS740	330 - 820	0.002 - 0.006	-	-
	High carbon steel and alloy steel (1045, 4140, etc.)	200 ~ 300	First choice	AH725	330 - 660	0.004 - 0.008	-	-
		200 ~ 300	For wear resistance	T3130	330 - 660	0.004 - 0.008	-	-
		200 ~ 300	For surface appearance	NS740	330 - 660	0.002 - 0.005	-	-
Tool steel (H13, etc.)	150 ~ 300	First choice	AH725	330 - 500	0.003 - 0.006	-	-	
	150 ~ 300	For wear resistance	T3130	330 - 500	0.003 - 0.006	-	-	
M	Stainless steel (304SS, 316SS, 17-4 PH, etc.)	-	-	AH130	260 - 660	-	0.003 - 0.008	-
K	Gray cast iron (Class 25, Class 30, etc.)	150 ~ 250	First choice	AH120	330 - 820	0.005 - 0.01	-	-
		150 ~ 250	For wear resistance	T1215 T1115	330 - 820	0.005 - 0.01	-	-
	Ductile cast iron (60-40-18, 60-55-06, etc.)	150 ~ 250	First choice	AH120	260 - 660	0.005 - 0.01	-	-
		150 ~ 250	For wear resistance	T1215 T1115	260 - 660	0.005 - 0.01	-	-
N	Aluminum alloys (Si < 13%)	-	-	DS1100	1000 - 3300	-	-	0.002 - 0.008
	Aluminum alloys (Si ≥ 13%)	-	-	DS1100	330 - 660	-	-	0.002 - 0.008
	Copper alloys	-	-	KS05F	660 - 1650	-	-	0.002 - 0.008
S	Titanium alloys (Ti-6Al-4V, etc.)	-	-	AH130	60 - 200	-	0.003 - 0.006	-
	Superalloys (Inconel 718, etc.)	-	-	AH725	60 - 130	0.003 - 0.005	-	-

CAUTIONARY POINT IN MODIFYING CUTTER BODIES

When using inserts with corner radius $r_{\epsilon} \geq 0.079$ " (2.0 mm), standard cutter bodies have to be modified "R".
(Only for TPS11, EPS11, TLS11, ELS11, HPO11)

- From 2nd row onwards, please use insert with $r_{\epsilon} = 0.016$ " or 0.031 "
- For application range see page D068.

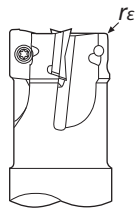

Corner radius r_{ϵ} (in)	The dimension of modifying (in)
0.016 - 0.063	Unnecessary
0.079 - 0.118	0.080

STANDARD CUTTING CONDITIONS

Roughing type TLS11 / ELS11

ISO	Workpiece material	Brinell hardness HB	Priority	Grade	Cutting speed: Vc (sfm)	Feed per tooth: fz (ipt)		
						MJ	MS	AJ
P	Low carbon steel (1018, 1020, 1026, etc.)	~ 200	First choice	AH725	330 - 820	0.002 - 0.007	-	-
		~ 200	For wear resistance	T3130	330 - 820	0.002 - 0.007	-	-
	High carbon steel and alloy steel (1045, 4140, etc.)	200 ~ 300	First choice	AH725	330 - 660	0.003 - 0.006	-	-
		200 ~ 300	For wear resistance	T3130	330 - 660	0.003 - 0.006	-	-
	Tool steel (H13, etc.)	150 ~ 300	First choice	AH725	330 - 500	0.003 - 0.006	-	-
		150 ~ 300	For wear resistance	T3130	330 - 500	0.003 - 0.006	-	-
M	Stainless steel (304SS, 316SS, 17-4 PH, etc.)	-	-	AH130	330 - 500	-	0.003 - 0.006	-
K	Gray cast iron (Class 25, Class 30, etc.)	150 ~ 250	First choice	AH120	330 - 800	0.004 - 0.007	-	-
		150 ~ 250	For wear resistance	T1215 T1115	330 - 800	0.004 - 0.007	-	-
	Ductile cast iron (60-40-18, 60-55-06, etc.)	150 ~ 250	First choice	AH120	260 - 650	0.004 - 0.007	-	-
		150 ~ 250	For wear resistance	T1215 T1115	260 - 650	0.004 - 0.007	-	-
N	Aluminum alloys (Si ≥ 13%)	-	-	DS1100	650 - 1650	-	-	0.002 - 0.007
	Aluminum alloys (Si ≥ 13%)	-	-	DS1100	330 - 650	-	-	0.002 - 0.007
S	Titanium alloys (Ti-6Al-4V, etc.)	-	-	AH130	60 - 200	0.003 - 0.006	-	-
	Superalloys (Inconel 718, etc.)	-	-	AH725	60 - 130	0.003 - 0.005	-	-

- To remove excessive chip accumulation use an air blast.
- To avoid build up edge on the cutting edges (aluminium machining), use a water soluble coolant.
- When cutting an interrupted surface or a casted skin, the feed per tooth (fz) should be reduced to the lower recommended value shown in the above table.

- Cutting conditions are limited by machine power, workpiece rigidity, and spindle output. When the cutting width, depth, or overhang length is large, set Vc and fz to the lower recommended values and check the machine power and vibration.



Shoulder Milling

MEMO



Shoulder Milling

A.R. = +14° ~ +17°, R.R. = +22° ~ +31°

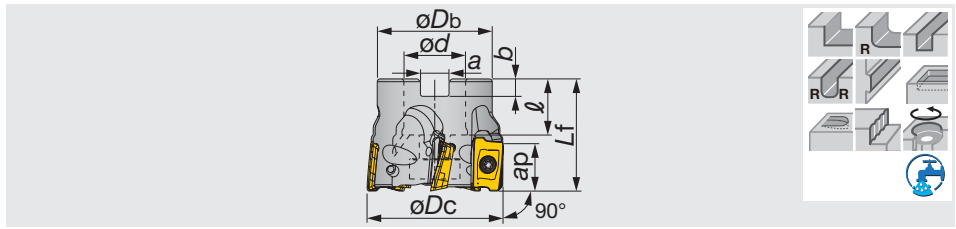

Inch	Max. ap	$\varnothing D_c$	z	$\varnothing D_b$	L_f	$\varnothing d$	ℓ	a	b	lb	Air hole	Insert
TPO18R200U0075A05	0.657	2.000	5	1.625	1.570	0.750	0.750	0.315	0.197	0.780	with	AO*T1805...
TPO18R250U0075A06	0.657	2.500	6	2.125	1.570	0.750	0.750	0.315	0.197	1.320	with	AO*T1805...
TPO18R300U0100A07	0.657	3.000	7	2.250	1.750	1.000	1.000	0.374	0.236	1.890	with	AO*T1805...
TPO18R400U0150A08	0.657	4.000	8	3.000	2.000	1.500	1.060	0.630	0.354	3.140	without	AO*T1805...
TPO18R500U0150A09	0.657	5.000	9	4.000	2.000	1.500	1.060	0.630	0.354	6.270	without	AO*T1805...
TPO18R600U0200A10	0.657	6.000	10	4.750	2.000	2.000	1.060	0.748	0.394	8.370	without	AO*T1805...

SPARE PARTS



Designation	Clamping screw	Grip	Torx bit	Center bolt (Optional parts)
TPO18R200,250...	CSTB-4L093	H-TBS	BT15M	(C0.375X1.125H)
TPO18R300...	CSTB-4L120	H-TBS	BT15M	(C0.500X1.375H)
TPO18R400,500,600...	CSTB-4L120	H-TBS	BT15M	-

Shoulder Milling

Reference pages

Inserts, Standard cutting conditions → **D067**

A.R. = +14° ~ +17°, R.R. = +22° ~ +31°

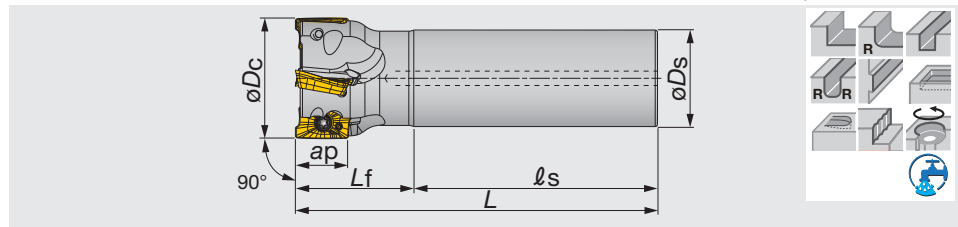

Shoulder Milling

Inch	Max. ap	ϕD_c	z	ϕD_s	l_s	L_f	L	lb	Air hole	Insert
EPO18R100U0100W02	0.657	1.000	2	1.000	2.250	1.750	4.000	0.730	with	AO*T1805...
EPO18R100U0100W02L	0.657	1.000	2	1.000	2.250	2.750	5.000	0.910	with	AO*T1805...
EPO18R125U0125W03	0.657	1.250	3	1.250	2.250	2.250	4.500	1.320	with	AO*T1805...
EPO18R125U0125W03L	0.657	1.250	3	1.250	2.250	4.250	6.500	1.880	with	AO*T1805...
EPO18R150U0125W03L	0.657	1.500	3	1.250	2.250	4.250	6.500	2.420	with	AO*T1805...
EPO18R150U0125W04	0.657	1.500	4	1.250	2.250	2.250	4.500	1.460	with	AO*T1805...
EPO18R200U0125W05	0.657	2.000	5	1.250	2.250	2.250	4.500	1.680	with	AO*T1805...

SPARE PARTS



Designation	Clamping screw	Wrench
EPO18R100U...	CSTB-4L085	T-15DB
EPO18R125U - 200U...	CSTB-4L093	T-15DB

Reference pages

Inserts, Standard cutting conditions → **D067**

INSERT

AOMT18-MJ

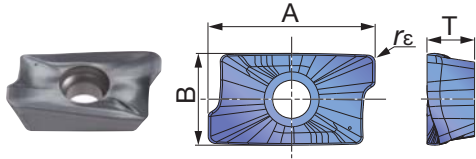

AOGT18-AJ

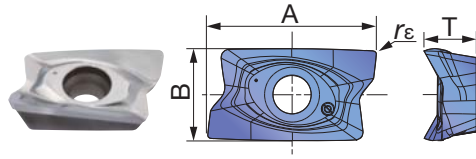

P	Steel	★							
M	Stainless	★	☆						
K	Cast iron	★							
N	Non-ferrous			★					
S	Superalloys	★							
H	Hard materials								

★ : First choice
☆ : Second choice

Designation	r _ε	Max. ap	Coated			Un-coated											A	B	T							
			AH140	AH725	KS15F																					
AOMT180508PDPR-MJ	0.031	0.657	●	●																				0.768	0.421	0.220
AOMT180516PDPR-MJ	0.063	0.657	●	●																				0.768	0.421	0.220
AOMT180524PDPR-MJ	0.094	0.657	●	●																				0.768	0.421	0.220
AOMT180532PDPR-MJ	0.126	0.657	●	●																				0.768	0.421	0.220
AOGT180504PDFR-AJ	0.016	0.657			●																			0.780	0.425	0.240
AOGT180508PDFR-AJ	0.031	0.657			●																			0.780	0.425	0.240

● : Line up



Shoulder Milling

STANDARD CUTTING CONDITIONS

TPO18/EPO18 type

ISO	Workpiece material	Brinell hardness HB	Grade	Cutting speed V _c (sfm)	Feed per tooth: fz (ipt)	
					MJ	AJ
P	Low carbon steel (1018, 1020, 1026, etc.)	~ 200	AH725	330 - 820	0.003 - 0.010	-
	High carbon steel and alloy steel (1045, 4140, etc.)	200 ~ 300	AH725	330 - 750	0.003 - 0.008	-
	Tool steel (H13, etc.)	150 ~ 300	AH725	330 - 600	0.003 - 0.008	-
M	Stainless steel (304SS, 316SS, 17-4 PH, etc.)	-	AH140	330 - 660	0.003 - 0.008	-
K	Gray cast iron (Class 25, Class 30, etc.)	150 ~ 250	AH725	330 - 820	0.003 - 0.010	-
	Ductile cast iron (60-40-18, 60-55-06, etc.)	150 ~ 250	AH725	260 - 660	0.003 - 0.010	-
N	Aluminum alloys (Si < 13%)	-	KS15F	1000 - 3300	-	0.002 - 0.010
	Aluminum alloys (Si ≥ 13%)	-	KS15F	330 - 660	-	0.002 - 0.010
S	Titanium alloys (Ti-6Al-4V, etc.)	-	AH725	60 - 200	0.003 - 0.007	-
	Superalloys (Inconel 718, etc.)	-	AH725	60 - 130	0.003 - 0.006	-

- To remove excessive chip accumulation use an air blast.
- To avoid build up edge on the cutting edges (aluminum machining), use a water soluble coolant.
- When cutting an interrupted surface or a casted skin, the feed per tooth (fz) should be reduced to the lower recommended value shown in the above table.

- Cutting conditions are limited by machine power, workpiece rigidity, and spindle output. When the cutting width, depth, or overhang length is large, set V_c and f_z to the lower recommended values and check the machine power and vibration.

APPLICATION RANGE

Shoulder Milling

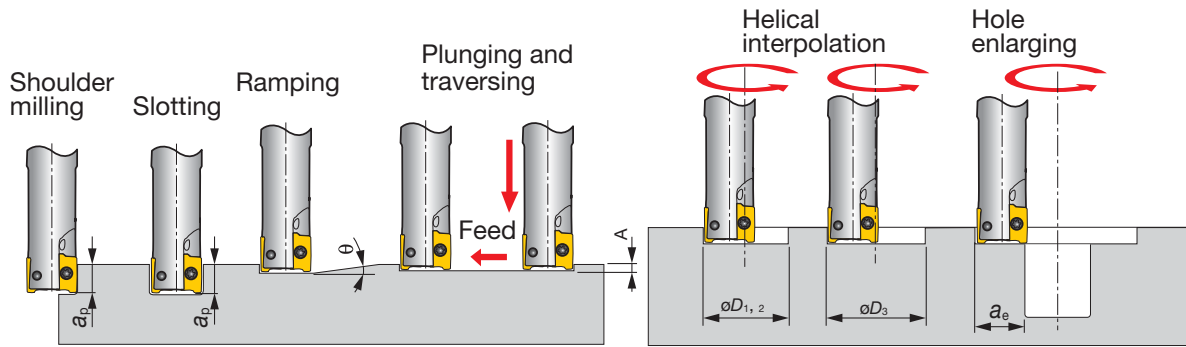

	Tool dia.	Chipbreaker	Max. depth of cut	Max. ramping angle	Max. plunging depth	Min. machining	Max. machining		Max. cutting width in enlarging
Inch	ϕDc		ap	θ°	A	$\phi D1$	$\phi D2$	$\phi D3^*$	ae
EPO07R050U0050-02	0.500	MJ, AJ	0.276	7.5	0.020	0.750	0.862	0.862	0.480
	0.524	HJ	0.031	4.5	0.030	0.786	-	-	0.406
EPO07R063U0063-04	0.625	MJ, AJ	0.276	5	0.020	0.938	1.112	1.112	0.610
	0.649	HJ	0.031	4	0.030	0.974	-	-	0.531
EPO07R075U0075-05	0.750	MJ, AJ	0.276	3.5	0.020	1.125	1.362	1.362	0.730
	0.774	HJ	0.031	2.5	0.030	1.161	-	-	0.656
EPO07R100U...	1.000	MJ, AJ	0.276	2.4	0.020	1.500	1.862	1.862	0.980
	1.024	HJ	0.031	2	0.030	1.536	-	-	0.906
EPS11050...	0.500	MJ, MS, AJ	0.417	6	0.020	0.590	0.882	0.882	0.480
EPS11062...	0.625	MJ, MS, AJ	0.417	5	0.020	0.790	1.332	1.332	0.610
EPS11075...	0.750	MJ, MS, AJ	0.417	3	0.020	1.100	1.382	1.382	0.730
EPS11100...	1.000	MJ, MS, AJ	0.417	2	0.020	1.500	1.882	1.882	0.980
EPS11125...	1.250	MJ, MS, AJ	0.417	1.5	0.020	2.050	2.382	2.382	1.230
EPO18R100U...	1.000	MJ, AJ	0.657	5.5	0.039	1.272	1.764	1.764	0.961
EPO18R125U...	1.250	MJ, AJ	0.657	3.5	0.039	1.772	2.264	2.264	1.211
EPO18R150U...	1.500	MJ, AJ	0.657	2.7	0.039	2.272	2.764	2.764	1.461
T/EPO18R200U...	2.000	MJ, AJ	0.657	1.9	0.039	3.272	3.764	3.764	1.961

	Tool dia.	Chipbreaker	Max. depth of cut	Max. ramping angle	Max. plunging depth	Min. machining	Max. machining		Max. cutting width in enlarging
Inch	ϕDc		ap	θ°	A	$\phi D1$	$\phi D2$	$\phi D3^*$	ae
TPO07R200U0075A12	2.000	MJ, AJ	0.276	0.9	0.020	3.000	3.960	3.862	1.980
	2.024	HJ	0.031	0.6	0.030	3.036	4.008	-	1.906
TPS11200RBU	2.000	MJ, MS, AJ	0.417	0.7	0.020	3.460	3.900	3.882	1.950
TPS11300RBU	3.000	MJ, MS, AJ	0.417	0.4	0.020	5.830	6.260	5.882	3.130
TPS11400RBU	4.000	MJ, MS, AJ	0.417	0.3	0.020	7.400	7.830	7.882	3.920
TPO18R250U0075A06	2.500	MJ, AJ	0.657	1.4	0.039	4.272	4.921	4.764	2.461
TPO18R300U0100A07	3.000	MJ, AJ	0.657	1.1	0.039	5.272	5.921	5.764	2.961
TPO18R400U0150A08	4.000	MJ, AJ	0.657	0.8	0.039	7.272	7.921	7.764	3.961
TPO18R500U0150A09	5.000	MJ, AJ	0.657	0.6	0.039	9.272	9.921	9.764	4.961
TPO18R600U0200A10	6.000	MJ, AJ	0.657	0.5	0.039	11.272	11.921	11.764	5.961

*Flat bottom hole

Notes: Corner r_c for dimensions of $\phi D1$, $\phi D2$, and $\phi D3$: $r_c = 0.016"$ for EPO07 / EPS11 and $r_c = 0.031"$ for EPO18.

Highly dense square shoulder mills with small SDMT/SDHT05 inserts

A.R. = +5°, R.R. = -7° ~ +12°

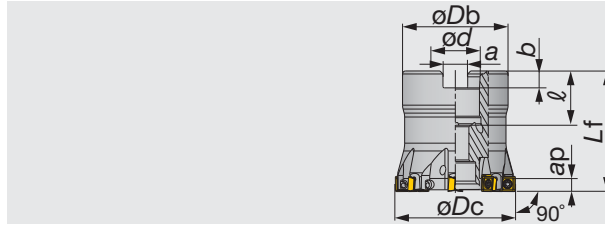

Right hand (R) shown.

Inch	Max. ap	ϕDc	z	ϕDb	L_f	ϕd	ℓ	a	b	lb	Air hole	Insert
TPD05R150U0075A08	0.157	1.500	8	1.461	1.570	0.750	0.750	0.313	0.170	0.220	with	SD*T0502...
TPD05R200U0075A10	0.157	2.000	10	1.750	1.570	0.750	0.750	0.313	0.170	0.440	with	SD*T0502...

SPARE PARTS



Designation	Clamping screw	Wrench	Center bolt (Optional parts)
TPD05...	CSPB-2L043	IP-6DB	(C0.375X1.125H)

Shoulder Milling

EPD05

Highly dense square shoulder endmills with small SDMT/SDHT05 inserts

A.R. = +5°, R.R. = -7° ~ +12°

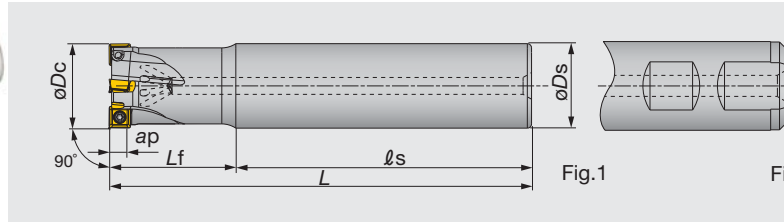

Right hand (R) shown.

Inch	Max. ap	ϕDc	z	ϕDs	ℓ_s	L_f	L	lb	Air hole	Shank	Insert	Shank type
EPD05R050U0050-02	0.157	0.500	2	0.500	1.780	1.220	3.000	0.220	with	Straight	SD*T0502...	Fig.1
EPD05R063U0063-03	0.157	0.625	3	0.625	2.000	1.500	3.500	0.440	with	Straight	SD*T0502...	Fig.1
EPD05R075U0075W04	0.157	0.750	4	0.750	2.030	1.720	3.750	0.440	with	Weldon	SD*T0502...	Fig.2
EPD05R100U0100W05	0.157	1.000	5	1.000	2.280	1.720	4.000	0.660	with	Weldon	SD*T0502...	Fig.2
EPD05R125U0100W06	0.157	1.250	6	1.250	2.280	1.720	4.000	1.100	with	Weldon	SD*T0502...	Fig.2

SPARE PARTS



Designation	Clamping screw	Wrench
EPD05...	CSPB-2L043	IP-6DB

ELD05

Highly dense square shoulder endmills for roughing with small SDMT/SDHT05 inserts

A.R. = +5°, R.R. = -3°

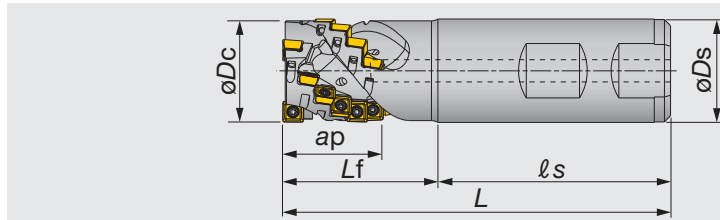

Inch	Max. ap	ϕDc	Z eff	z	ϕDs	ℓ_s	L_f	L	lb	Air hole	Insert
ELD05R075U0075W02	0.799	0.750	2	10	0.750	2.031	1.219	3.250	0.440	with	SD*T0502...
ELD05R025M25.0W03	0.953	1.000	3	18	1.000	2.250	1.500	3.750	0.670	with	SD*T0502...

SPARE PARTS



Designation	Clamping screw	Wrench
ELD05...	CSPB-2L043	IP-6DB

Reference pages

Inserts → D070, Standard cutting conditions → D070 - D071

INSERT

SDMT05-MJ

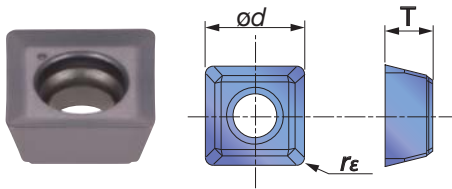

SDHT05-AJ

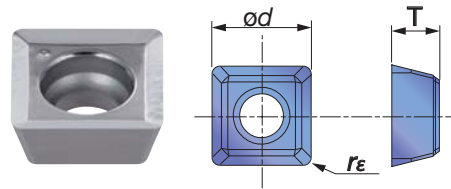

Shoulder Milling

P Steel	★								
M Stainless	★	☆							
K Cast iron	★								
N Non-ferrous				★					
S Superalloys	★								
H Hard materials									

★ : First choice
☆ : Second choice

Designation	$r\epsilon$	Max. ap	Coated			Un-coated					T	ϕd	
			AH140	AH725	TH10								
SDMT050204PN-MJ	0.016	0.157	●	●								0.094	0.200
SDHT050204FN-AJ	0.016	0.157			●							0.094	0.200

● : Line up

STANDARD CUTTING CONDITIONS

■ Bore, shank type TPD05/EPD05

ISO	Workpiece material	Brinell hardness HB	Grade	Cutting speed Vc (sfm)	Feed per tooth fz (ipt)
P	Low carbon steel (1018, 1020, 1026, etc.)	~ 200	AH725	750 - 1050	0.0015 - 0.004
	High carbon steel (1045, 1055, etc.)	200 ~ 300	AH725	500 - 750	0.0015 - 0.004
	Alloyed steel (4140, 8620, etc.)	150 ~ 300	AH725	500 - 750	0.0015 - 0.004
	Tool steel (W1-8, etc.)	~ 300	AH725	350 - 440	0.001 - 0.0035
M	Stainless steel (304SS, 316SS, 17-4 PH, etc.)	-	AH140	330 - 650	0.001 - 0.0035
K	Gray cast iron (Class 25, Class 30, etc.)	150 ~ 250	AH725	500 - 820	0.002 - 0.005
	Ductile cast iron (60-40-18, 60-55-06, etc.)	150 ~ 250	AH725	330 - 590	0.002 - 0.005
N	Aluminum alloys (Si < 13%)	-	TH10	1150 - 1600	0.002 - 0.006
	Aluminum alloys (Si ≥ 13%)	-	TH10	330 - 650	0.002 - 0.006
S	Titanium alloys Ti-6Al-4V, etc.	-	AH725	98 - 197	0.001 - 0.0035
	Heat-resistant alloys Inconel 718, etc.	-	AH725	33 - 131	0.001 - 0.003

* For deep and wide cutting, set the Vc and fz to the lower recommended limits and check the vibration and spindle load of the machine.

STANDARD CUTTING CONDITIONS

Roughing type ELD05

ISO	Workpiece material	Brinell hardness HB	Grade	Cutting speed Vc (sfm)	Feed per tooth fz (ipt)
P	Low carbon steel (1018, 1020, 1026, etc.)	~ 200	AH725	330 - 820	0.0015 - 0.004
	High carbon steel (1045, 1055, etc.)	200 ~ 300	AH725	330 - 660	0.0015 - 0.004
	Alloyed steel (4140, 8620, etc.)	150 ~ 300	AH725	330 - 660	0.0015 - 0.004
	Tool steel (W1-8, etc.)	~ 300	AH725	330 - 400	0.0012 - 0.0035
M	Stainless steel (304SS, 316SS, 17-4 PH, etc.)	-	AH140	300 - 500	0.0012 - 0.0035
K	Gray cast iron (Class 25, Class 30, etc.)	150 ~ 250	AH725	330 - 820	0.002 - 0.005
	Ductile cast iron (60-40-18, 60-55-06, etc.)	150 ~ 250	AH725	260 - 660	0.002 - 0.005
N	Aluminum alloys (Si < 13%)	-	TH10	660 - 1650	0.002 - 0.006
	Aluminum alloys (Si ≥ 13%)	-	TH10	330 - 650	0.002 - 0.006
S	Titanium alloys Ti-6Al-4V, etc.	-	AH725	98 - 197	0.001 - 0.0035
	Heat-resistant alloys Inconel 718, etc.	-	AH725	33 - 131	0.001 - 0.003



Shoulder Milling

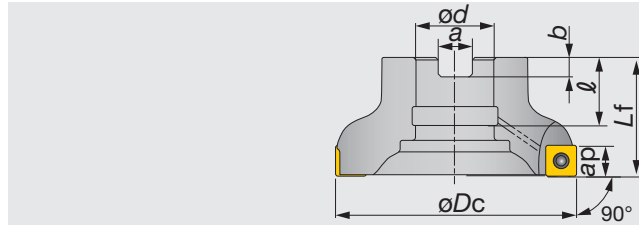

Right hand (R) shown.

Shoulder Milling

Inch	Max. ap	ϕD_c	z	L_f	ϕd	ℓ	a	b	lb	Airhole	Insert
TPW13R200U0075A03	0.394	2.000	3	1.575	0.750	0.750	0.315	0.197	0.660	with	SW*T1304...
TPW13R200U0075A04	0.394	2.000	4	1.575	0.750	0.750	0.315	0.197	0.660	with	SW*T1304...
TPW13R200U0075A05	0.394	2.000	5	1.575	0.750	0.750	0.315	0.197	0.660	with	SW*T1304...
TPW13R300U0100A04	0.394	3.000	4	1.969	1.000	1.024	0.374	0.236	1.760	with	SW*T1304...
TPW13R300U0100A06	0.394	3.000	6	1.969	1.000	1.024	0.374	0.236	1.540	with	SW*T1304...
TPW13R300U0100A08	0.394	3.000	8	1.969	1.000	1.024	0.374	0.236	1.760	with	SW*T1304...
TPW13R400U0150A05	0.394	4.000	5	1.969	1.500	1.378	0.626	0.394	3.530	with	SW*T1304...
TPW13R400U0150A07	0.394	4.000	7	1.969	1.500	1.378	0.626	0.394	3.310	with	SW*T1304...
TPW13R400U0150A10	0.394	4.000	10	1.969	1.500	1.378	0.626	0.394	3.310	with	SW*T1304...
TPW13R500U0150A06	0.394	5.000	6	2.480	1.500	1.457	0.626	0.394	5.510	with	SW*T1304...
TPW13R500U0150A08	0.394	5.000	8	2.480	1.500	1.457	0.626	0.394	5.290	with	SW*T1304...
TPW13R500U0150A12	0.394	5.000	12	2.480	1.500	1.457	0.626	0.394	5.510	with	SW*T1304...
TPW13R600U0200A08	0.394	6.000	8	2.480	2.000	1.496	0.748	0.433	7.940	with	SW*T1304...
TPW13R600U0200A12	0.394	6.000	12	2.480	2.000	1.496	0.748	0.433	8.160	with	SW*T1304...
TPW13R600U0200A15	0.394	6.000	15	2.480	2.000	1.496	0.748	0.433	8.160	without	SW*T1304...

SPARE PARTS

Designation	① Clamping screw	Lubricant	② Shim screw	Center bolt	Center bolt 1	③ Shim	Wrench for ①	Wrench for ②
TPW13R200...	CSPB-3.5	M-1000	DTS5-3.5SS	-	C0.375X1.25H	FSSP1102	IP-15D	P-3.5
TPW13R300...	CSPB-3.5	M-1000	DTS5-3.5SS	-	C0.5X1.5H	FSSP1102	IP-15D	P-3.5
TPW13R400,500...	CSPB-3.5	M-1000	DTS5-3.5SS	TMBA-0.750H	-	FSSP1102	IP-15D	P-3.5
TPW13R600...	CSPB-3.5	M-1000	DTS5-3.5SS	-	-	FSSP1102	IP-15D	P-3.5

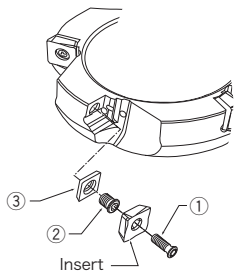

Reference pages

Inserts → **D074**, Standard cutting conditions → **D075**

EPW13

Square shoulder endmills with screw clamped SWMT/SWGT13 inserts

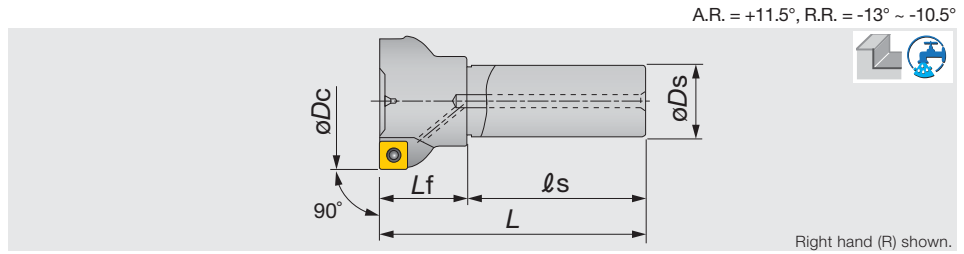

Metric	Max. ap	ϕD_c	z	ϕD_s	l_s	L_f	L	Kg	Air hole	Insert
EPW13R032M32.0-02	10	32	2	32	80	35	115	0.6	with	SW*T1304...
EPW13R040M32.0-03	10	40	3	32	80	35	115	0.7	with	SW*T1304...
EPW13R050M32.0-03	10	50	3	32	80	40	120	0.9	with	SW*T1304...
EPW13R050M32.0-04	10	50	4	32	80	40	120	0.9	with	SW*T1304...
EPW13R063M32.0-04	10	63	4	32	80	40	120	1	with	SW*T1304...
EPW13R063M32.0-05	10	63	5	32	80	40	120	1	with	SW*T1304...
EPW13R080M32.0-04	10	80	4	32	80	40	120	1.3	with	SW*T1304...
EPW13R080M32.0-06	10	80	6	32	80	40	120	0.8	with	SW*T1304...

SPARE PARTS

Designation	① Clamping screw	Lubricant	② Shim screw	③ Shim	Wrench for ①	Wrench for ②
EPW13R032, 040...	CSPB-3.5	M-1000	-	-	IP-15D	-
EPW13R050 - 080...	CSPB-3.5	M-1000	DTS5-3.5SS	FSSP1102	IP-15D	P-3.5

Shoulder Milling

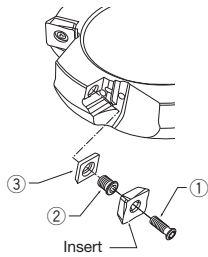

Reference pages

Inserts → **D074**, Standard cutting conditions → **D075**

INSERT

SWG1304-MJ

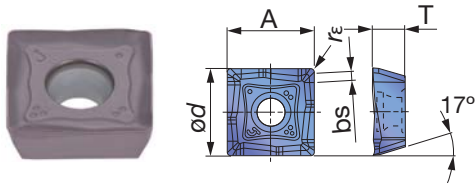

SWMT1304-MJ

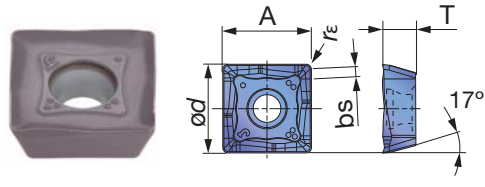

SWMT1304-ML

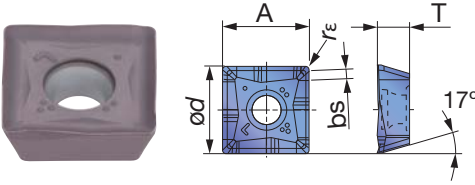

SWMT1304-MS

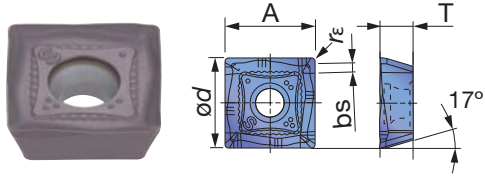

SWG1304-AJ

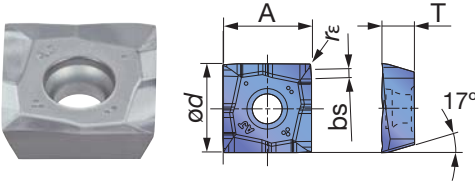

Shoulder Milling

P	Steel	★	☆	☆		☆	☆							
M	Stainless	☆	★	★										
K	Cast iron	☆			★									
N	Non-ferrous						★		★					
S	Superalloys													
H	Hard materials													

★ : First choice
☆ : Second choice

Designation	rε	Max. ap	Coated							Cermet	Un-coated	A	ød	T	bs			
			AH120	AH130	AH140	T1115	T1215	T3130	DS1100	NS740	KS05F							
SWG1304PDPR-MJ	0.031	0.394	●							●								
SWMT1304PDPR-MJ	0.031	0.394	●	●	●	●	●	●		●								
SWMT1304PDER-ML	0.031	0.394	●	●														
SWMT1304PDPR-MS	0.031	0.394		●	●													
SWG1304PDFR-AJ	0	0.394							●		●							

● : Line up

STANDARD CUTTING CONDITIONS TPW / EPW13 TYPE

ISO	Workpiece material	Recommended insert grade	Cutting speed Vc (sfm)	Roughing (Depth of cut: $a_p \geq 0.040''$) Feed per tooth: fz (ipt)				Light cutting to finishing (Depth of cut: $a_p \leq 0.040''$) Feed per tooth: fz (ipt)				
				MJ	ML	MS	AJ	MJ	ML	MS	AJ	
P	Mild steel Low carbon steel ($< 180\text{HB}$)	AH120 (First choice)	330 - 890	0.002 - 0.010	0.002 - 0.008	-	-	0.002 - 0.008	0.002 - 0.007	-	-	
		T3130 (Priority on wear resistance)	500 - 980	0.002 - 0.010	-	-	-	0.002 - 0.008	-	-	-	
		AH130 / AH140 (Priority on impact resistance)	260 - 590	0.002 - 0.010	-	0.002 - 0.008	-	0.002 - 0.008	-	0.002 - 0.007	-	
		NS740 (Priority on surface finish)	330 - 980	0.002 - 0.006	-	-	-	0.002 - 0.005	-	-	-	
	Carbon steel Alloy steel ($< 300\text{HB}$)	AH120 (First choice)	330 - 760	0.002 - 0.008	0.002 - 0.006	-	-	0.002 - 0.007	0.002 - 0.005	-	-	
		T3130 (Priority on wear resistance)	490 - 920	0.002 - 0.008	-	-	-	0.002 - 0.007	-	-	-	
		AH130 / AH140 (Priority on impact resistance)	260 - 490	0.002 - 0.008	-	-	-	0.002 - 0.007	-	-	-	
		NS740 (Priority on surface finish)	330 - 760	0.002 - 0.006	-	-	-	0.002 - 0.005	-	-	-	
	Die steel ($< 30\text{HRC}$)	AH120 (First choice)	330 - 590	0.002 - 0.006	0.002 - 0.005	-	-	0.002 - 0.005	0.002 - 0.004	-	-	
		T3130 (Priority on wear resistance)	330 - 590	0.002 - 0.006	-	-	-	0.002 - 0.005	-	-	-	
	M	Stainless steel ($< 250\text{HB}$)	AH130 / AH140 (First choice)	260 - 650	0.002 - 0.008	-	0.002 - 0.007	-	0.002 - 0.007	-	0.002 - 0.006	-
			AH120 (Priority on wear resistance)	490 - 820	0.002 - 0.008	0.002 - 0.006	-	-	0.002 - 0.007	0.002 - 0.005	-	-
K	Gray cast iron	T1215 (First choice)	330 - 820	0.002 - 0.008	-	-	-	0.002 - 0.007	-	-	-	
		AH120 (Priority on impact resistance)	330 - 820	0.002 - 0.008	0.002 - 0.006	-	-	0.002 - 0.007	0.002 - 0.005	-	-	
N	Aluminum alloys (Si $< 13\%$)	DS1100 / KS05F (First choice)	980 - 3300	-	-	-	0.002 - 0.008	-	-	-	0.002 - 0.008	
	Aluminum alloys (Si $\geq 13\%$)	DS1100 / KS05F (First choice)	260 - 980	-	-	-	0.002 - 0.008	-	-	-	0.002 - 0.008	
	Copper alloys	DS1100 / KS05F (First choice)	660 - 1650	-	-	-	0.002 - 0.008	-	-	-	0.002 - 0.008	

Notes:

- When machining at large depth of cut or large cutting width, Vc and fz should be reduced.
- As a rule, dry machining (including air blow) is recommended. But, for excessive chip welding, such as when machining stainless steels, use a water soluble cutting fluid. In this case, use AH140 and set the cutting speed to $V_c \leq 328$ sfm.
- When machining mild steel, carbon steel or alloy steel in wet conditions T3130 is recommended. In this case, Vc and fz should be reduced.
- TPW13 type can not be used for ramping, plunging and drilling.



Shoulder Milling

A.R. = +4° ~ +5°, R.R. = +13° ~ +15°

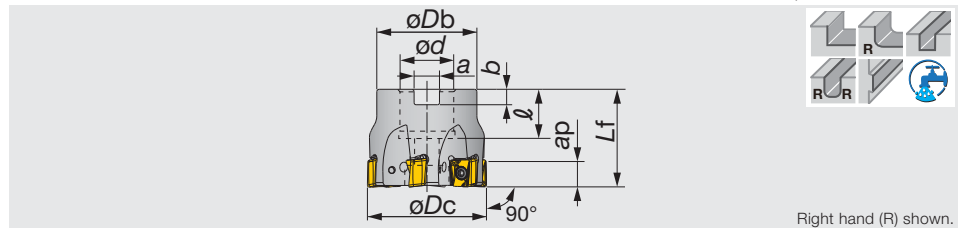

Right hand (R) shown.

Shoulder Milling

Inch	Max. ap	ϕDc	z	ϕDb	Lf	ϕd	ℓ	a	b	lb	Air hole	Insert
TPQ11R200U0075A06	0.354	2.000	6	1.693	1.575	0.750	0.787	0.320	0.187	0.88	with	LQMU1107...
TPQ11R250U0075A07	0.354	2.500	7	1.693	1.575	0.750	0.787	0.320	0.187	1.32	with	LQMU1107...
TPQ11R300U0100A10	0.354	3.000	10	2.165	1.969	1.000	1.024	0.383	0.219	2.31	with	LQMU1107...
TPQ11R400U0150A12	0.354	4.000	12	3.150	1.969	1.500	1.496	0.633	0.375	4.41	with	LQMU1107...
TPQ18R200U0075A03	0.630	2.000	3	1.772	1.575	0.750	0.750	0.320	0.187	0.88	with	LQMU1808...
TPQ18R250U0100A04	0.630	2.500	4	2.165	1.969	1.000	1.024	0.383	0.219	1.76	with	LQMU1808...
TPQ18R300U0100A05	0.630	3.000	5	2.165	1.969	1.000	1.024	0.383	0.219	2.43	with	LQMU1808...
TPQ18R400U0150A06	0.630	4.000	6	3.150	1.969	1.500	1.496	0.633	0.375	3.75	with	LQMU1808...
TPQ18R500U0150A08	0.630	5.000	8	3.150	2.480	1.500	1.693	0.626	0.394	6.17	with	LQMU1808...
TPQ18R600U0200A09	0.630	6.000	9	3.937	2.480	2.000	1.811	0.758	0.437	9.04	without	LQMU1808...

SPARE PARTS

Designation	Clamping screw	Grip	Torx bit	Center bolt (Optional parts)
TPQ11R200,250...	CSTB-3.5L115	SW6-SD	BLDT10/S7	(C0.375X1.125H)
TPQ11R300...	CSTB-3.5L115	SW6-SD	BLDT10/S7	(C0.500X1.375H)
TPQ11R400...	CSTB-3.5L115	SW6-SD	BLDT10/S7	-
TPQ18R200,250...	CSTB-3.5L115	SW6-SD	BLDT10/S7	(C0.375X1.125H)
TPQ18R300...	CSTB-3.5L115	SW6-SD	BLDT10/S7	(C0.500X1.137H)
TPQ18R400,500,600...	CSTB-3.5L115	SW6-SD	BLDT10/S7	-

A.R. = +4° ~ +5°, R.R. = +13° ~ +15°

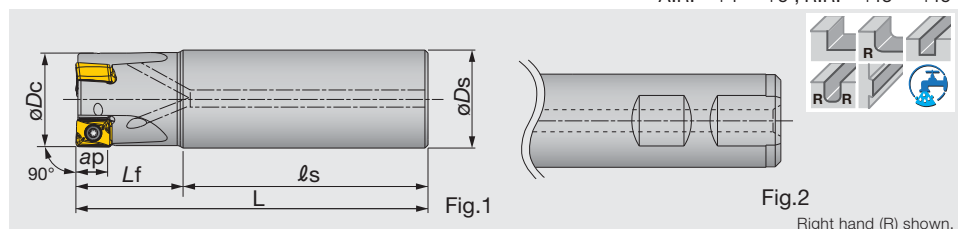

Right hand (R) shown.

Inch	Max. ap	ϕDc	z	ϕDs	ℓ_s	Lf	L	lb	Air hole	Insert	Shank style
EPQ11R100U0100W02	0.354	1.000	2	1.000	2.280	1.220	3.500	0.750	with	LQMU1107...	Fig.2
EPQ11R125U0125W03	0.354	1.250	3	1.250	2.500	1.500	4.000	1.540	with	LQMU1107...	Fig.2
EPQ11R150U0125W04	0.354	1.500	4	1.250	2.250	1.750	4.000	1.650	with	LQMU1808...	Fig.2

SPARE PARTS

Designation	Clamping screw	Grip	Grip 1	Torx bit	Wrench*
EPQ11R100,125,150...	CSTB-3.5L115	SW6-SD	-	BLDT10/S7	T-10D

*: Monoblock type substitution is not possible.

Reference pages

Inserts, Standard cutting conditions → D077

INSERT

LQMU11/18-MJ

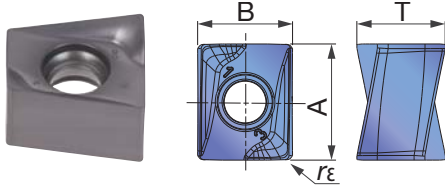

P Steel	☆	★	★
M Stainless	★	★	☆
K Cast iron	★	★	☆
N Non-ferrous			
S Superalloys	★	★	
H Hard materials			

★ : First choice
☆ : Second choice

Designation	rε	Max. ap	Coated			A	T	B
			AH120	AH140	AH725			
LQMU110704PNER-MJ	0.016	0.354	●	●	●	0.433	0.327	0.016
LQMU110708PNER-MJ	0.031	0.354	●	●	●	0.433	0.327	0.031
LQMU110716PNER-MJ	0.063	0.354	●	●	●	0.433	0.327	0.063
LQMU180804PNER-MJ	0.016	0.630	●	●	●	0.689	0.433	0.016
LQMU180808PNER-MJ	0.031	0.630	●	●	●	0.689	0.433	0.031
LQMU180816PNER-MJ	0.063	0.630	●	●	●	0.689	0.433	0.063
LQMU180824PNER-MJ	0.094	0.630	●	●	●	0.689	0.433	0.094

● : Line up

STANDARD CUTTING CONDITIONS

ISO	Workpiece material	Hardness HB	Grade	Cutting speed Vc (sfm)	Feed per tooth fz (ipt)
P	Low carbon steel (1018, 1020, 1026, etc.)	- 200	AH725	330 - 800	0.004 - 0.010
	High carbon steel (1045, 1055, etc.)	200 - 300	AH725	330 - 750	0.004 - 0.008
	Alloyed steel (4140, 8620, etc.)	150 - 300	AH725	330 - 750	0.004 - 0.008
	Tool steel (H13, D2, etc.)	- 300	AH725	330 - 600	0.004 - 0.008
M	Stainless steel (304SS, 316SS, 17-4 PH, etc.)	-	AH140	300 - 600	0.004 - 0.010
K	Gray cast iron (Class 25, Class 30, etc.)	150 - 250	AH120	450 - 800	0.004 - 0.010
	Ductile cast iron (60-40-18, 60-55-06, etc.)	150 - 250	AH120	450 - 800	0.004 - 0.010
S	Heat-resistant alloy (Inconel 718, etc.)	-	AH725	65 - 160	0.003 - 0.008

· To remove excessive chip accumulation use an air blast.
· When cutting an interrupted surface or a casted skin, the feed per tooth (fz) should be reduced to the lower recommended value shown in the above table.

· Cutting conditions are limited by machine power, work piece rigidity and spindle output. When the cutting width, depth or over hang length is large, set Vc and fz to the lower recommended values and check the machine power and vibration.

Shoulder Milling

A.R. = +5° ~ +6°, R.R. = +9° ~ +13°

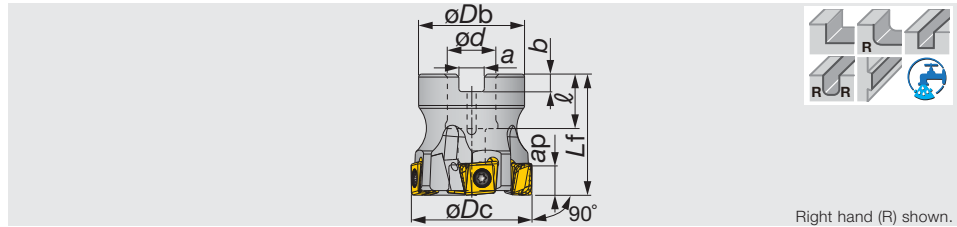

Right hand (R) shown.

Inch	Max. ap	ϕDc	z	ϕDb	Lf	ϕd	ℓ	a	b	lb	Air hole	Insert
TPM11R200U0075A05	0.381	2.000	5	1.770	1.570	0.750	0.750	0.320	0.240	0.66	with	LMMU1107...
TPM11R250U0075A06	0.381	2.500	6	1.770	1.570	0.750	0.750	0.320	0.240	1.10	with	LMMU1107...
TPM11R300U0100A06	0.381	3.000	6	2.170	1.970	1.000	0.750	0.390	0.240	1.98	with	LMMU1107...
TPM11R300U0100A08	0.381	3.000	8	2.170	1.970	1.000	0.750	0.390	0.240	2.20	with	LMMU1107...
TPM11R400U0150A08	0.381	4.000	8	3.070	1.970	1.500	1.060	0.630	0.310	3.09	with	LMMU1107...
TPM11R400U0150A11	0.381	4.000	11	3.070	1.970	1.500	1.060	0.630	0.310	3.31	with	LMMU1107...
TPM16R300U0100A05	0.594	3.000	5	2.170	1.970	1.000	0.750	0.390	0.240	2.20	with	LMMU1609...
TPM16R400U0150A06	0.594	4.000	6	3.070	1.970	1.500	1.060	0.630	0.310	3.53	with	LMMU1609...
TPM16R500U0150A07	0.594	5.000	7	3.070	2.480	1.500	1.060	0.630	0.390	6.61	with	LMMU1609...

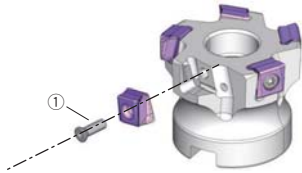

SPARE PARTS

Designation	① Clamping screw	Grip	Torx bit	Center bolt (Optional parts)
TPM11R200, 250...	CSTB-3.5L110	H-TB	BT15S	(C0.375X1.125H)
TPM11R300...	CSTB-3.5L110	H-TB	BT15S	(C0.500X1.375H)
TPM11R400...	CSTB-3.5L110	H-TB	BT15S	(TMBA-0.750H)
TPM16R300...	CSTB-5L159	H-TB	BT20S	(C0.500X1.375H)
TPM16R400, 500...	CSTB-5L159	H-TB	BT20S	(TMBA-0.750H)

A.R. = +5° ~ +6°, R.R. = +9° ~ +13°

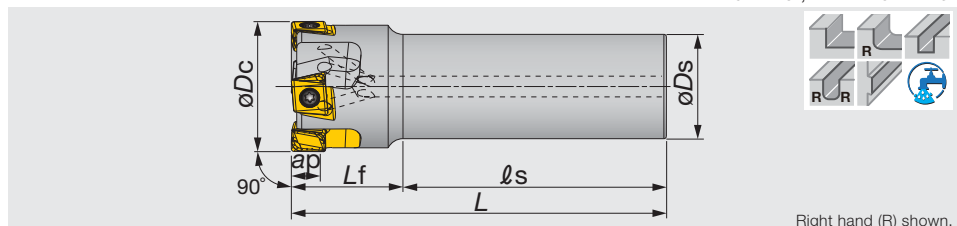

Right hand (R) shown.

Inch	Max. ap	ϕDc	z	ϕDs	ℓs	Lf	L	lb	Air hole	Insert
EPM11R125U0125W03	0.381	1.250	3	1.250	2.250	1.750	4.000	0.66	with	LMMU1107...
EPM11R150U0125W04	0.381	1.500	4	1.250	2.250	1.750	4.000	1.10	with	LMMU1107...

SPARE PARTS

Designation	Clamping screw	Wrench
EPM11...	CSTB-3.5L110	T-15DB

Reference pages

Inserts → D079, Standard cutting conditions → D080

A.R. = +5° ~ +6°, R.R. = +9° ~ +13°

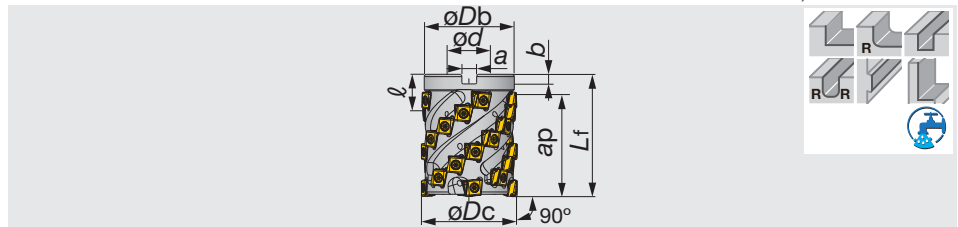

Inch	Max. ap	ϕDc	Z eff	z	ϕDb	Lf	ϕd	ℓ	a	b	l_b	Air hole	Insert
TLM11R200U0075A03	2.303	2.000	3	21	1.850	2.750	0.750	0.750	0.315	0.157	1.78	with	LMMU1107...
TLM11R250U0100A04	2.634	2.500	4	32	2.323	3.250	1.000	0.750	0.374	0.197	3.33	with	LMMU1107...

SPARE PARTS



Designation	Clamping screw	Grip	Torx bit	Center bolt
TLM11R200...	SM35-114-H0	H-TB	BT15S	SD06-A2
TLM11R250...	SM35-114-H0	H-TB	BT15S	SD08-52

INSERT

LMMU11/16-MJ

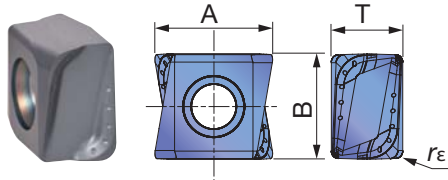

	P	M	K	N	S	H
Steel	☆					☆
Stainless		★	☆			
Cast iron	★		☆	☆		
Non-ferrous						
Superalloys	★		★			
Hard materials						

★ : First choice
☆ : Second choice

Designation	r_ϵ	Max. ap	Coated				A	B	T	
			AH120	AH140	AH725	T1115				T3130
LMMU110708PNER-MJ	0.031	0.381	●	●	●	●	●	0.460	0.413	0.280
LMMU110716PNER-MJ	0.063	0.381	●	●	●	●	●	0.453	0.413	0.280
LMMU110724PNER-MJ	0.094	0.381	●	●	●	●	●	0.445	0.413	0.280
LMMU110732PNER-MJ	0.126	0.381	●	●	●	●	●	0.437	0.413	0.280
LMMU160908PNER-MJ	0.031	0.594	●	●	●	●	●	0.681	0.630	0.375
LMMU160916PNER-MJ	0.063	0.594	●	●	●	●	●	0.673	0.630	0.375
LMMU160924PNER-MJ	0.094	0.594	●	●	●	●	●	0.665	0.630	0.375
LMMU160932PNER-MJ	0.126	0.594	●	●	●	●	●	0.661	0.630	0.375

● : Line up

Reference pages

Standard cutting conditions → D080

STANDARD CUTTING CONDITIONS

TPM11, 16 / EPM11

ISO	Workpiece materials	Brinell hardness HB	Priority	Grade	Cutting speed Vc (sfm)	Feed per tooth fz (ipt)
P	Low carbon steels 1018, 8620 etc.	- 200	First choice	AH725	350 - 800	.005 - .012
		- 200	For impact resistance	AH140	260 - 600	.005 - .012
		- 200	For wear resistance	T3130	390 - 800	.005 - .012
	High carbon steels F-61 80 etc.	200 - 300	First choice	AH725	350 - 750	.005 - .012
		200 - 300	For impact resistance	AH140	260 - 600	.005 - .012
		200 - 300	For wear resistance	T3130	390 - 800	.005 - .012
	Alloyed steels 4140, 4340 etc.	150 - 300	First choice	AH725	350 - 750	.005 - .010
		150 - 300	For impact resistance	AH140	260 - 500	.005 - .010
		150 - 300	For wear resistance	T3130	390 - 800	.005 - .010
Tool steels A-6, D-1, D-2 etc.	- 300	First choice	AH725	350 - 600	.005 - .010	
	- 300	For impact resistance	AH140	260 - 390	.005 - .010	
	- 300	For wear resistance	T3130	350 - 600	.005 - .010	
M	Stainless steels 300 series, 304, 316 etc.	-	First choice	AH140	300 - 600	.005 - .012
K	Grey cast irons 250 etc.	150 - 250	First choice	AH120	450 - 800	.005 - .012
		150 - 250	For wear resistance	T1115	450 - 800	.005 - .012
	Ductile cast irons 450-10S etc.	150 - 250	First choice	AH120	360 - 640	.005 - .012
		150 - 250	For wear resistance	T1115	360 - 640	.005 - .012
S	Heat-resisting alloy Inconel 718 / Ti-6Al-4V etc.	-	First choice	AH725	75 - 200	.004 - .008

- To remove excessive chip accumulation use an air blast.
- When cutting an interrupted surface or a casting skin, the feed (fz) should be reduced to the lower recommended value shown in the above table.

- Cutting conditions are limited by machine power, work piece rigidity and spindle output. When the cutting width, depth or overhang length is large, set Vc and fz to the lower recommended values and check the machine power and vibration.

TLM11

ISO	Workpiece materials	Brinell hardness HB	Priority	Grade	Cutting speed Vc (sfm)	Feed per tooth fz (ipt)
P	Low carbon steels 1018, 8620 etc.	- 200	First choice	AH725	330 - 800	.004 - .009
		- 200	For impact resistance	AH140	260 - 600	.004 - .009
		- 200	For wear resistance	T3130	330 - 800	.004 - .009
	High carbon steels F-61 80 etc.	200 - 300	First choice	AH725	330 - 660	.004 - .009
		200 - 300	For impact resistance	AH140	260 - 500	.004 - .009
		200 - 300	For wear resistance	T3130	330 - 660	.004 - .009
	Alloyed steels 4140, 4340 etc.	150 - 300	First choice	AH725	330 - 660	.003 - .008
		150 - 300	For impact resistance	AH140	260 - 500	.003 - .008
		150 - 300	For wear resistance	T3130	330 - 660	.003 - .008
Tool steels A-6, D-1, D-2 etc.	- 300	First choice	AH725	330 - 500	.003 - .008	
	- 300	For impact resistance	AH140	260 - 390	.003 - .008	
	- 300	For wear resistance	T3130	330 - 500	.003 - .008	
M	Stainless steels 300 series, 304, 316 etc.	-	First choice	AH140	300 - 500	.003 - .008
K	Grey cast irons 250 etc.	150 - 250	First choice	AH120	330 - 800	.004 - .010
		150 - 250	For wear resistance	T1115	330 - 800	.004 - .010
	Ductile cast irons 450-10S etc.	150 - 250	First choice	AH120	260 - 500	.004 - .010
		150 - 250	For wear resistance	T1115	260 - 500	.004 - .010
S	Heat-resisting alloy Inconel 718 / Ti-6Al-4V etc.	-	First choice	AH725	75 - 200	.002 - .006

TUNG-ALUMILL

TPV16

90° shoulder milling shellmills with screw clamped XVCT16 inserts for aluminum machining

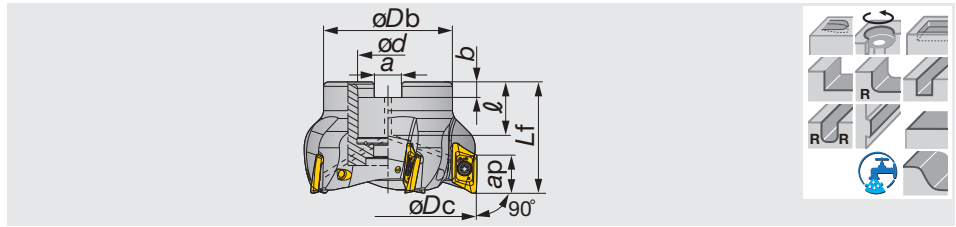

Inch	$\varnothing D_c$	z	$\varnothing D_b$	$\varnothing d$	ℓ	L_f	a	b	l _b	Air hole	Max. rpm (min ⁻¹)	Insert
TPV16R150U0075A03	1.500	3	1.421	0.750	0.750	2.000	0.315	0.170	0.440	with	30,000	XVCT1605...
TPV16R200U0075A04	2.000	4	1.890	0.750	0.750	2.000	0.315	0.170	0.890	with	27,000	XVCT1605...
TPV16R250U0100A05	2.500	5	2.165	1.000	0.750	2.000	0.375	0.197	1.340	with	24,000	XVCT1605...
TPV16R300U0100A05	3.000	5	2.362	1.000	0.750	2.000	0.375	0.197	1.920	with	21,000	XVCT1605...
TPV16R400U0150A06	4.000	6	3.150	1.500	1.059	2.500	0.625	0.319	4.280	with	19,000	XVCT1605...
TPV16R500U0150A07	5.000	7	3.740	1.500	1.059	2.500	0.625	0.319	6.700	with	17,000	XVCT1605...

SPARE PARTS

Designation	Clamping screw	Grip	Torx bit	Center bolt (Optional parts)
TPV16R150...	TS40093I/HG	H-TBS	BT15S	(TCS 9.525-35-I)
TPV16R200...	TS40093I/HG	H-TBS	BT15S	(SD06-46)
TPV16R250,300...	TS40093I/HG	H-TBS	BT15S	(SD08-47)
TPV16R400,500...	TS40093I/HG	H-TBS	BT15S	(SD12-82)

Shoulder Milling

TUNG-ALUMILL

EPV16

90° endmills with screw clamped XVCT16 inserts for aluminum machining

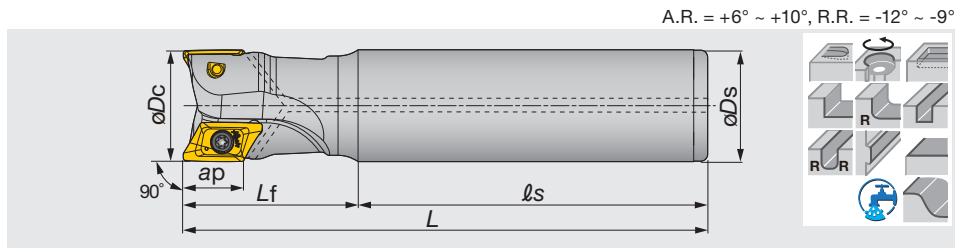

Inch	$\varnothing D_c$	z	$\varnothing D_s$	ℓ_s	L_f	L	l _b	Air hole	Max. rpm (min ⁻¹)	Insert
EPV16R100U0100W02	1.000	2	1.000	3.000	2.000	5.000	0.820	with	38,000	XVCT1605...
EPV16R100U0100W02L	1.000	2	1.000	4.000	3.000	7.000	1.170	with	38,000	XVCT1605...
EPV16R125U0125W02	1.250	2	1.250	4.000	2.000	6.000	1.690	with	34,000	XVCT1605...
EPV16R125U0125W02L	1.250	2	1.250	5.000	3.000	8.000	2.280	with	34,000	XVCT1605...
EPV16R125U0125W03	1.250	3	1.250	4.000	2.000	6.000	1.680	with	34,000	XVCT1605...
EPV16R125U0125W03L	1.250	3	1.250	5.000	3.000	8.000	2.270	with	34,000	XVCT1605...
EPV16R150U0125W03	1.500	3	1.250	5.000	2.000	7.000	2.080	with	30,000	XVCT1605...
EPV16R150U0125W03L	1.500	3	1.250	8.000	2.000	10.000	3.140	with	30,000	XVCT1605...

SPARE PARTS

Designation	Clamping screw	Grip	Torx bit
EPV16R100...	TS40085I/HG	H-TBS	BT15S
EPV16R125,150...	TS40093I/HG	H-TBS	BT15S

Reference pages

Inserts, Standard cutting conditions → D082

INSERT

XVCT16-AJ

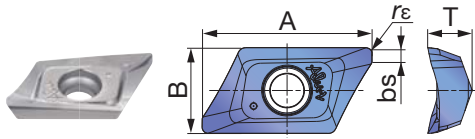

P	Steel		
M	Stainless		
K	Cast iron		
N	Non-ferrous	★	
S	Superalloys		
H	Hard materials		

★ : First choice
☆ : Second choice

Designation	rε	Max. ap	Un-coated										A	B	T	bs		
			TH10															
XVCT160504R-AJ	0.016	0.630	●												0.874	0.442	0.232	0.051
XVCT160508R-AJ	0.031	0.630	●												0.874	0.442	0.232	0.039
XVCT160512R-AJ	0.047	0.610	●												0.854	0.442	0.228	0.039
XVCT160516R-AJ	0.063	0.591	●												0.835	0.442	0.226	0.039
XVCT160520R-AJ	0.079	0.571	●												0.819	0.442	0.226	0.039
XVCT160524R-AJ	0.094	0.551	●												0.800	0.442	0.224	0.039
XVCT160530R-AJ	0.118	0.551	●												0.768	0.442	0.220	0.039
XVCT160532R-AJ	0.126	0.551	●												0.756	0.442	0.220	0.039
XVCT160540R-AJ	0.157	0.512	●												0.724	0.442	0.217	0.047
XVCT160550R-AJ	0.197	0.512	●												0.724	0.442	0.213	0.016

● : Line up

STANDARD CUTTING CONDITIONS

ISO	Workpiece material	Hardness HB	Grade	Chip-breaker	Cutting speed Vc (sfm)	Feed per tooth fz (ipt)
N	Aluminum alloy	60	TH10	AJ	900 - 1600	0.006 - 0.015
					650 - 6600	0.004 - 0.010
	Cast aluminum alloy Si ≤ 12%	100	TH10	AJ	650 - 6600	0.006 - 0.012
					650 - 5000	0.004 - 0.010
	Cast aluminum alloy Si > 12%	75	TH10	AJ	650 - 3200	0.003 - 0.006
					650 - 2600	0.003 - 0.006
	Cast aluminum alloy Si > 12%	90	TH10	AJ	900 - 3200	0.004 - 0.006
					900 - 2600	0.004 - 0.006
	Copper alloys Pb > 1%	130	TH10	AJ	300 - 1600	0.004 - 0.006
					300 - 900	0.004 - 0.006
	Copper alloys	110	TH10	AJ	900 - 1600	0.006 - 0.015
					650 - 6600	0.004 - 0.010
	Copper alloys	90	TH10	AJ	650 - 6600	0.006 - 0.012
					650 - 5000	0.004 - 0.010
Duroplastics, fiber plastics	100	TH10	AJ	650 - 3200	0.003 - 0.006	
				650 - 2600	0.003 - 0.006	
Hard rubber	-	TH10	AJ	900 - 3200	0.004 - 0.006	
				900 - 2600	0.004 - 0.006	
				300 - 1600	0.004 - 0.006	
				300 - 900	0.004 - 0.006	

Safety guidelines

1. Use only the original inserts, cutters and spare parts.
2. Insert pocket must be cleaned before clamping the insert.
3. Clamp torque of screw should be 3.3 lbf-ft.
4. For safety reasons, use a new screw when changing the insert.
5. Maximum RPM values are determined based on the burst test. Using RPM beyond maximum values may cause insert breakage, machine damage or personal injury.
6. XVCT insert has sharp cutting edges. Always wear gloves for protection from injury when handling.

APPLICATION RANGE

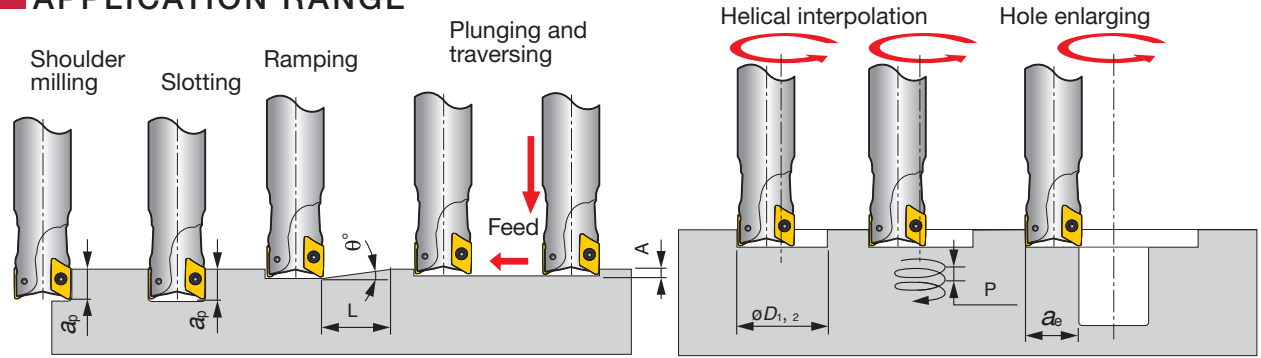

Inch	Tool ϕD_c	Corner radius r_c	Max. depth of cut a_p	Max. ramping angle θ°	Straight ramp down		Step down		Helical ramp down		Hole enlarging
					Min. length L	Max. plunging depth A	Min. machining ϕD_1	Min. pitch/rev P	Max. machining ϕD_2	Max. pitch/rev P	Max. width a_e
EPV16R100...	1.000	0.016, 0.031	0.630	22°	1.570	0.166	1.150	0.173	1.970	0.535	0.886
EPV16R100...	1.000	0.047	0.610	22°	1.570	0.166	1.150	0.173	1.970	0.535	0.886
EPV16R100...	1.000	0.063	0.591	22°	1.500	0.146	1.150	0.173	1.970	0.520	0.886
EPV16R100...	1.000	0.079	0.571	22°	1.500	0.146	1.150	0.173	1.970	0.520	0.886
EPV16R100...	1.000	0.118, 0.126	0.551	21°	1.500	0.098	1.150	0.165	1.970	0.484	0.886
EPV16R100...	1.000	0.157, 0.197	0.512	18.5°	1.570	0.090	1.150	0.146	1.970	0.484	0.886
EPV16R125...	1.250	0.016, 0.031	0.630	16.5°	2.130	0.158	1.690	0.346	2.520	0.535	1.134
EPV16R125...	1.250	0.047	0.610	16.5°	2.130	0.158	1.690	0.346	2.520	0.535	1.134
EPV16R125...	1.250	0.063	0.591	16°	2.130	0.138	1.690	0.335	2.520	0.520	1.134
EPV16R125...	1.250	0.079	0.571	16°	2.130	0.138	1.690	0.335	2.520	0.520	1.134
EPV16R125...	1.250	0.118, 0.126	0.551	15°	2.130	0.118	1.700	0.311	2.520	0.484	1.134
EPV16R125...	1.250	0.157, 0.197	0.512	13.5°	2.200	0.098	1.700	0.280	2.520	0.484	1.134
T/EPV16R150...	1.500	0.016, 0.031	0.630	11.5°	3.110	0.158	2.330	0.409	3.150	0.535	1.417
T/EPV16R150...	1.500	0.047	0.610	11.5°	3.110	0.158	2.330	0.409	3.150	0.535	1.417
T/EPV16R150...	1.500	0.063	0.591	11°	3.150	0.138	2.330	0.390	3.150	0.520	1.417
T/EPV16R150...	1.500	0.079	0.571	11°	3.150	0.138	2.330	0.390	3.150	0.520	1.417
T/EPV16R150...	1.500	0.118, 0.126	0.551	10°	3.230	0.118	2.330	0.354	3.150	0.484	1.417
T/EPV16R150...	1.500	0.157, 0.197	0.512	8.5°	3.540	0.098	2.330	0.299	3.150	0.484	1.417
TPV16R200...	2.000	0.016, 0.031	0.630	9.5°	3.780	0.158	3.110	0.512	3.940	0.535	1.772
TPV16R200...	2.000	0.047	0.610	9.5°	3.780	0.158	3.110	0.512	3.940	0.535	1.772
TPV16R200...	2.000	0.063	0.591	9°	3.860	0.138	3.110	0.484	3.940	0.520	1.772
TPV16R200...	2.000	0.079	0.571	9°	3.860	0.138	3.110	0.484	3.940	0.520	1.772
TPV16R200...	2.000	0.118, 0.126	0.551	8°	4.060	0.118	3.110	0.429	3.940	0.484	1.772
TPV16R200...	2.000	0.157, 0.197	0.512	7°	4.330	0.098	3.110	0.374	3.940	0.484	1.772
TPV16R250...	2.500	0.016, 0.031	0.630	7°	5.120	0.158	4.130	0.535	4.960	0.535	2.232
TPV16R250...	2.500	0.047	0.610	7°	5.120	0.158	4.130	0.535	4.960	0.535	2.232
TPV16R250...	2.500	0.063	0.591	6.5°	5.350	0.138	4.130	0.504	4.960	0.520	2.232
TPV16R250...	2.500	0.079	0.571	6.5°	5.350	0.138	4.130	0.504	4.960	0.520	2.232
TPV16R250...	2.500	0.118, 0.126	0.551	6°	5.350	0.118	4.140	0.465	4.960	0.484	2.232
TPV16R250...	2.500	0.157, 0.197	0.512	5.5°	5.510	0.098	4.140	0.425	4.960	0.484	2.232
TPV16R300...	3.000	0.016, 0.031	0.630	5°	7.200	0.158	5.470	0.535	6.300	0.535	2.835
TPV16R300...	3.000	0.047	0.610	5°	7.200	0.158	5.470	0.535	6.300	0.535	2.835
TPV16R300...	3.000	0.063	0.591	4.5°	7.760	0.138	5.470	0.488	6.300	0.520	2.835
TPV16R300...	3.000	0.079	0.571	4.5°	7.760	0.138	5.470	0.488	6.300	0.520	2.835
TPV16R300...	3.000	0.118, 0.126	0.551	4°	8.150	0.118	5.480	0.433	6.300	0.484	2.835
TPV16R300...	3.000	0.157, 0.197	0.512	3.5°	8.700	0.098	5.480	0.378	6.300	0.484	2.835
TPV16R400...	4.000	0.016, 0.031	0.630	3.5°	10.310	0.158	7.040	0.508	7.870	0.535	3.543
TPV16R400...	4.000	0.047	0.610	3.5°	10.310	0.158	7.040	0.508	7.870	0.535	3.543
TPV16R400...	4.000	0.063	0.591	3°	11.650	0.138	7.040	0.437	7.870	0.520	3.543
TPV16R400...	4.000	0.079	0.571	3°	11.650	0.138	7.040	0.437	7.870	0.520	3.543
TPV16R400...	4.000	0.118, 0.126	0.551	2.5°	13.070	0.118	7.050	0.362	7.870	0.484	3.543
TPV16R400...	4.000	0.157, 0.197	0.512	2.5°	12.170	0.098	7.050	0.362	7.870	0.457	3.543
TPV16R500...	5.000	0.016, 0.031	0.630	2.5°	14.450	0.158	9.020	0.476	9.840	0.535	4.429
TPV16R500...	5.000	0.047	0.610	2.5°	14.450	0.158	9.020	0.476	9.840	0.535	4.429
TPV16R500...	5.000	0.063	0.591	2°	17.480	0.138	9.020	0.382	9.840	0.520	4.429
TPV16R500...	5.000	0.079	0.571	2°	17.480	0.138	9.020	0.382	9.840	0.520	4.429
TPV16R500...	5.000	0.118, 0.126	0.551	1.5°	21.810	0.118	9.020	0.287	9.840	0.343	4.429
TPV16R500...	5.000	0.157, 0.197	0.512	1.5°	20.310	0.098	9.020	0.287	9.840	0.343	4.429

Shoulder Milling

HYBRIDTACMILL

EPH

High precision square shoulder endmills in small diameter with XHGR type insert

Shoulder Milling

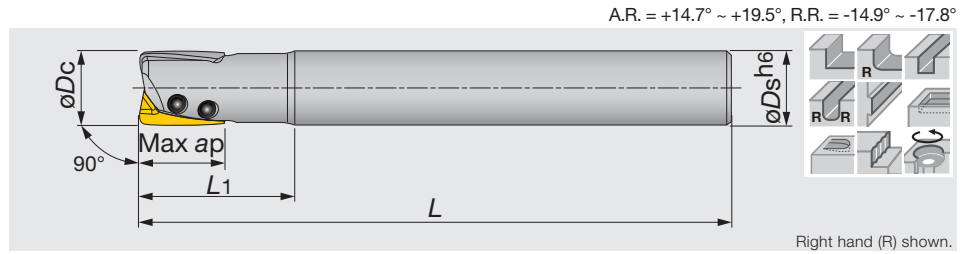

Inch	Max. ap	ϕD_c	z	ϕD_s	L	L ₁	Insert
EPH13R050U0050-2	0.472	0.500	2	0.500	3.500	1.000	XHGR1302...
EPH18R063U0063-2	0.630	0.625	2	0.625	4.000	1.250	XHGR18T2...
EPH18R075U0075-3	0.630	0.750	3	0.750	4.000	1.500	XHGR18T2...
EPH18R100U0100-4	0.630	1.000	4	1.000	4.000	2.000	XHGR18T2...

Metric	Max. ap	ϕD_c	z	ϕD_s	L	L ₁	Insert
EPH11R010M10.0-2	10	10	2	10	80	21	XHGR1102...
EPH11R010M10.0-2L	10	10	2	10	100	36	XHGR1102...
EPH13R012M12.0-2	12	12	2	12	80	25	XHGR1302...
EPH13R012M12.0-2L	12	12	2	12	110	43	XHGR1302...
EPH13R013M12.0-2	12	13	2	12	110	25	XHGR1302...
EPH13R014M12.0-2	12	14	2	12	110	25	XHGR1302...
EPH18R016M16.0-2	16	16	2	16	100	33	XHGR18T2...
EPH18R016M16.0-2L	16	16	2	16	130	56	XHGR18T2...
EPH18R016M16.0-3	16	16	3	16	100	33	XHGR18T2...
EPH18R016M16.0-3L	16	16	3	16	130	56	XHGR18T2...
EPH18R017M16.0-3	16	17	3	16	130	33	XHGR18T2...
EPH18R018M16.0-3	16	18	3	16	130	33	XHGR18T2...
EPH18R020M20.0-3	16	20	3	20	110	41	XHGR18T2...
EPH18R020M20.0-3L	16	20	3	20	140	71	XHGR18T2...
EPH18R021M20.0-3	16	21	3	20	140	41	XHGR18T2...
EPH18R025M25.0-4	16	25	4	25	120	51	XHGR18T2...
EPH18R025M25.0-4L	16	25	4	25	160	88.5	XHGR18T2...
EPH18R026M25.0-4	16	26	4	25	160	51	XHGR18T2...

SPARE PARTS

Designation	① Clamping screw	Wrench	Wrench 1
EPH11R...	CSP-2L033	-	IP-6F
EPH13R...	CSPB-2.2SH	IP-7D	-
EPH18R...	CSPB-2.5SH	IP-7D	-

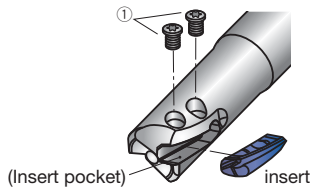

Reference pages

Inserts → **D085 - D086**, Standard cutting conditions → **D087**

EPH with slim shank

High precision square shoulder endmills with XHGR type insert, slim shank for small lathes

A.R. = +14.7° ~ +19.5°, R.R. = -14.9° ~ -17.8°

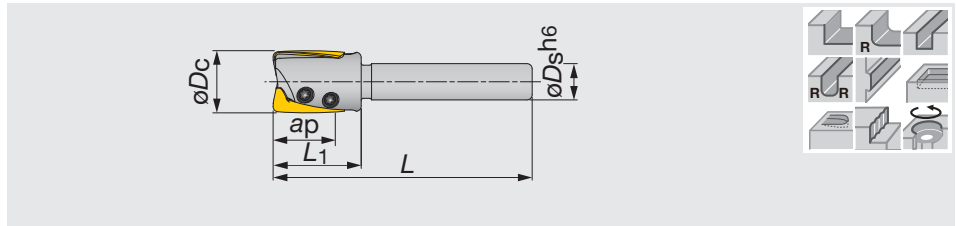

Metric	Max.ap	$\varnothing D_c$	z	$\varnothing D_s$	L	L1	Insert
EPH11R010M06.0-2	10	10	2	6	50	15	XHGR1102...
EPH13R012M07.0-2	12	12	2	7	50	17	XHGR1302...
EPH18R016M10.0-3	16	16	3	10	60	22	XHGR18T2...
EPH18R020M10.0-3	16	20	3	10	60	22	XHGR18T2...

SPARE PARTS

Designation	Clamping screw	Wrench	Wrench 1
EPH11R010M06.0-2	CSP-2L033	-	IP-6F
EPH13R012M07.0-2	CSPB-2.2SH	IP-7D	-
EPH18R0**M10.0-3	CSPB-2.5SH	IP-7D	-

Shoulder Milling

INSERT

XHGR11/13/18-AJ

XHGR11/13/18-MJ

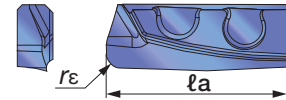
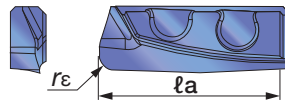

P	Steel	★							
M	Stainless	★							
K	Cast iron	★							
N	Non-ferrous		★						
S	Superalloys								
H	Hard materials								

★ : First choice
☆ : Second choice

Designation	r_ϵ	Max.ap	Coated		la
			AH730	DS1200	
XHGR110202ER-MJ	0.008	0.394	●		0.433
XHGR110204ER-MJ	0.016	0.394	●		0.433
XHGR110205ER-MJ	0.020	0.394	●		0.433
XHGR110208ER-MJ	0.031	0.394	●		0.433
XHGR110210ER-MJ	0.040	0.394	●		0.433
XHGR110212ER-MJ	0.047	0.394	●		0.433
XHGR110215ER-MJ	0.059	0.394	●		0.433
XHGR110216ER-MJ	0.063	0.394	●		0.433
XHGR110220ER-MJ	0.079	0.394	●		0.433
XHGR130202ER-MJ	0.008	0.472	●		0.512
XHGR130204ER-MJ	0.016	0.472	●		0.512
XHGR130205ER-MJ	0.020	0.472	●		0.512
XHGR130208ER-MJ	0.031	0.472	●		0.512
XHGR130210ER-MJ	0.040	0.472	●		0.512
XHGR130212ER-MJ	0.047	0.472	●		0.512
XHGR130215ER-MJ	0.059	0.472	●		0.512
XHGR130216ER-MJ	0.063	0.472	●		0.512
XHGR130220ER-MJ	0.079	0.472	●		0.512
XHGR18T202ER-MJ	0.008	0.630	●		0.709
XHGR18T204ER-MJ	0.016	0.630	●		0.709
XHGR18T205ER-MJ	0.020	0.630	●		0.709
XHGR18T208ER-MJ	0.031	0.630	●		0.709
XHGR18T210ER-MJ	0.040	0.630	●		0.709
XHGR18T212ER-MJ	0.047	0.630	●		0.709
XHGR18T215ER-MJ	0.059	0.630	●		0.709
XHGR18T216FR-MJ	0.063	0.630	●		0.709
XHGR18T220FR-MJ	0.079	0.630	●		0.709

Reference pages

● : Line up

Inserts → D085 - D086, Standard cutting conditions → D087

INSERT

XHGR11/13/18-AJ

XHGR11/13/18-MJ

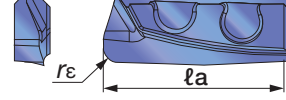
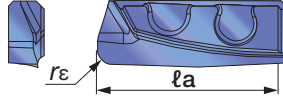

P	Steel	★																		
M	Stainless	★																		
K	Cast iron	★																		
N	Non-ferrous	★																		
S	Superalloys																			
H	Hard materials																			

★ : First choice
☆ : Second choice

Shoulder Milling

Designation	rε	Max. ap	Coated		la
			AH730	DS1200	
XHGR110200FR-AJ	0	0.394	●		0.433
XHGR110202FR-AJ	0.008	0.394	●		0.433
XHGR110204FR-AJ	0.016	0.394	●		0.433
XHGR110205FR-AJ	0.020	0.394	●		0.433
XHGR110208FR-AJ	0.031	0.394	●		0.433
XHGR110210FR-AJ	0.039	0.394	●		0.433
XHGR110212FR-AJ	0.047	0.394	●		0.433
XHGR110215FR-AJ	0.059	0.394	●		0.433
XHGR110216FR-AJ	0.062	0.394	●		0.433
XHGR110220FR-AJ	0.078	0.394	●		0.433
XHGR130200FR-AJ	0	0.472	●		0.512
XHGR130202FR-AJ	0.008	0.472	●		0.512
XHGR130204FR-AJ	0.016	0.472	●		0.512
XHGR130205FR-AJ	0.020	0.472	●		0.512
XHGR130208FR-AJ	0.031	0.472	●		0.512
XHGR130210FR-AJ	0.039	0.472	●		0.512
XHGR130212FR-AJ	0.047	0.472	●		0.512
XHGR130215FR-AJ	0.059	0.472	●		0.512
XHGR130216FR-AJ	0.062	0.472	●		0.512
XHGR130220FR-AJ	0.078	0.472	●		0.512
XHGR18T200FR-AJ	0	0.630	●		0.709
XHGR18T202FR-AJ	0.008	0.630	●		0.709
XHGR18T204FR-AJ	0.016	0.630	●		0.709
XHGR18T205FR-AJ	0.020	0.630	●		0.709
XHGR18T208FR-AJ	0.031	0.630	●		0.709
XHGR18T210FR-AJ	0.039	0.630	●		0.709
XHGR18T212FR-AJ	0.047	0.630	●		0.709
XHGR18T215FR-AJ	0.059	0.630	●		0.709
XHGR18T216FR-AJ	0.062	0.630	●		0.709
XHGR18T220FR-AJ	0.078	0.630	●		0.709

Note: When using inserts with a corner radius in excess of 0.039", additional work to the cutter body is needed. ● : Line up

STANDARD CUTTING CONDITIONS

Shoulder milling

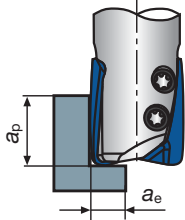

a_p : Axial depth of cut
 a_e : Radial depth of cut

ISO	Workpiece material	Cutting speed V_c (sfm)	Feed rate f_z (ipt)	Cutting conditions		
				$\phi 0.394 \leq \phi D_c < \phi 0.472$	$\phi 0.472 \leq \phi D_c < \phi 0.630$	$\phi 0.630 \leq \phi D_c \leq \phi 1.024$
P	Carbon steels Alloy steels < 30HRC	200 ~ 590	0.001 ~ 0.004	$V_c = 390$ sfm, $f_z = 0.003$ ipt		
				$a_p \leq 0.295''$	$a_p \leq 0.354''$	$a_p \leq 0.472''$
M	Alloy steels prehardened steels 30 ~ 40HRC	160 ~ 490	0.001 ~ 0.003	$V_c = 390$ sfm, $f_z = 0.0019$ ipt		
				$a_p \leq 0.217''$	$a_p \leq 0.256''$	$a_p \leq 0.354''$
M	Stainless steels < 250HB	160 ~ 490	0.001 ~ 0.002	$V_c = 330$ sfm, $f_z = 0.0157$ ipt		
				$a_p \leq 0.177''$	$a_p \leq 0.217''$	$a_p \leq 0.295''$
K	Cast irons	260 ~ 560	0.001 ~ 0.004	$V_c = 460$ sfm, $f_z = 0.00314$ ipt		
				$a_p \leq 0.374''$	$a_p \leq 0.374''$	$a_p \leq 0.610''$
N	Aluminum alloys Si < 12%	330 ~ 980	0.001 ~ 0.004	$V_c = 660$ sfm, $f_z = 0.00275$ ipt		
				$a_p \leq 0.374''$	$a_p \leq 0.374''$	$a_p \leq 0.610''$
N	Aluminum alloys Si > 13%	260 ~ 590	0.001 ~ 0.003	$V_c = 430$ sfm, $f_z = 0.0023$ ipt		
				$a_p \leq 0.374''$	$a_p \leq 0.374''$	$a_p \leq 0.610''$

Shoulder Milling

Slotting

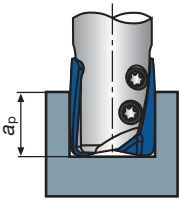

ISO	Workpiece material	Cutting speed V_c (sfm)	Feed rate f_z (ipt)	Cutting conditions				
				$\phi 0.394'' \leq \phi D_c < \phi 0.472''$	$\phi 0.472'' \leq \phi D_c < \phi 0.630''$	$\phi 0.630'' \leq \phi D_c \leq \phi 0.709''$	$\phi 0.709'' < \phi D_c \leq \phi 0.827''$	$\phi 0.827'' < \phi D_c \leq \phi 1.024''$
P	Carbon steels Alloy steels < 30HRC	200 ~ 590	0.001 ~ 0.004	$V_c = 330$ sfm, $f_z = 0.00236$ ipt				
				$a_p \leq 0.059''$	$a_p \leq 0.079''$	$a_p \leq 0.118''$	$a_p \leq 0.098''$	$a_p \leq 0.098''$
M	Alloy steels prehardened steels 30 ~ 40HRC	160 ~ 490	0.001 ~ 0.003	$V_c = 230$ sfm, $f_z = 0.00196$ ipt				
				$a_p \leq 0.039''$	$a_p \leq 0.059''$	$a_p \leq 0.079''$	$a_p \leq 0.059''$	$a_p \leq 0.059''$
M	Stainless steels < 250HB	160 ~ 490	0.001 ~ 0.002	$V_c = 230$ sfm, $f_z = 0.00157$ ipt				
				$a_p \leq 0.039''$	$a_p \leq 0.039''$	$a_p \leq 0.059''$	$a_p \leq 0.059''$	$a_p \leq 0.059''$
K	Cast irons	260 ~ 560	0.001 ~ 0.004	$V_c = 390$ sfm, $f_z = 0.00275$ ipt				
				$a_p \leq 0.138''$	$a_p \leq 0.157''$	$a_p \leq 0.177''$	$a_p \leq 0.138''$	$a_p \leq 0.118''$
N	Aluminum alloys Si < 12%	330 ~ 980	0.001 ~ 0.004	$V_c = 490$ sfm, $f_z = 0.00275$ ipt				
				$a_p \leq 0.138''$	$a_p \leq 0.157''$	$a_p \leq 0.177''$	$a_p \leq 0.138''$	$a_p \leq 0.118''$
N	Aluminum alloys Si > 13%	260 ~ 590	0.001 ~ 0.003	$V_c = 360$ sfm, $f_z = 0.00236$ ipt				
				$a_p \leq 0.138''$	$a_p \leq 0.157''$	$a_p \leq 0.177''$	$a_p \leq 0.138''$	$a_p \leq 0.118''$

Notes:

- When slotting, use a rigid machine.
- When chips stay in the cutting zone during slotting or pocketing, use air to remove chips from the work area.
- If chips tend to stick to the cutting edge (such as aluminum alloy machining), use a water soluble cutting fluid.
- If cutting a casting skin or heavily interrupted work surface, decrease the feed per tooth and maximum depth of cut to 1/2 to 2/3 times the values shown in the table.

- Tool overhang length must be as short as possible to avoid chatter. When the tool overhang length is long, decrease the number of revolutions and feed.
- Cutting conditions are generally limited by the rigidity and power of the machine and the rigidity of the workpiece. When setting the conditions, start from half of the values of the standard cutting conditions and then increase the value gradually while making sure the machine is running normally.

APPLICATION RANGE

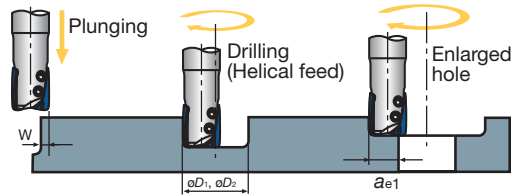
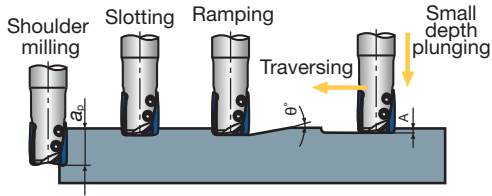

Shoulder Milling

Type	Inch	Tool ϕ	Max. depth of cut	Max. ramping angle	Max. plunging depth	Max. cutting width in plunging	Min. machinable hole ϕ	Max. machinable hole ϕ	Max. cutting width in enlarged hole
		ϕDc	ap	θ°	A	W	$\phi D1$	$\phi D2^*$	a_{e1}^*
Straight	EPH13R050U0050-2	0.500	0.470	2.5	0.012	0.110	0.670	0.930	0.480
	EPH18R063U0063-2	0.625	0.630	2.0	0.012	0.150	0.830	1.230	0.610
	EPH18R075U0075-3	0.750	0.630	2.0	0.012	0.150	1.260	1.470	0.730
	EPH18R100U0100-4	1.000	0.630	1.5	0.012	0.150	1.580	1.980	0.980

*Where the insert corner radius $\leq 0.008"$

Notes on using large radius inserts

When using the inserts which have a large corner radius in excess of 0.039", additional work is needed to the corner of the body.

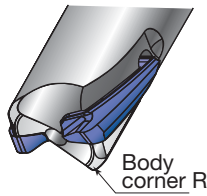

Insert corner radius r_E (in)	Required rework to body corner R (in)
$0 \leq r_E \leq 0.039$	No additional work
$0.039 < r_E \leq 0.078$	R0.079

Insert mounting procedure (EPH-type)

Fasten the inserts in order of A to B

- After loosening the clamping screws, insert the insert in the insert pocket of the body while pushing it with your finger.
- Lightly fasten the clamping screws in order of A and B.
- For all the inserts, carry out the above steps ① and ②.
- Securely tighten the clamping screws in order of A and B.
(Refer to the standard tightening torque values.)
- For all the inserts, carry out the above step ④.
- Check the condition of insert seating, clearance between the insert and insert pocket, the tool diameter, and the peripheral edge runout.

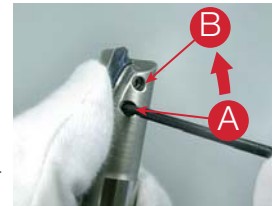

TPS17

Square shoulder mills with ASMT/ASGT17 inserts, suitable for multi purpose machining

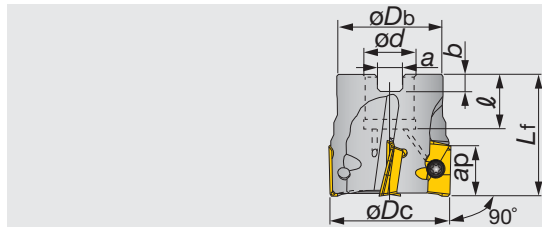

A.R. = +9°, R.R. = -20° ~ -7°



Right hand (R) shown.

Inch	Max. ap	ϕD_c	z	L_f	ϕd	ℓ	a	b	lb	Air hole	Insert
TPS17200RBU	0.630	2.000	4	1.580	0.750	0.750	0.315	0.200	0.200	with	AS*T1705...
TPS17300RBU	0.630	3.000	4	1.960	1.000	1.020	0.374	0.236	0.300	with	AS*T1705...
TPS17400RBU	0.630	4.000	5	2.480	1.500	1.260	0.630	0.350	0.800	with	AS*T1705...

SPARE PARTS

Designation	Clamping screw	Lubricant	Center bolt (Optional parts)	Center bolt 1 (Optional parts)	Center bolt 2 (Optional parts)	Wrench
TPS17200...	CSPB-4S	M-1000	(C0.375X1.125H)	-	-	IP-15D
TPS17300...	CSPB-4S	M-1000	-	(C0.500X1.375H)	-	IP-15D
TPS17400...	CSPB-4S	M-1000	-	-	(TMBA0.750H)	IP-15D

Shoulder Milling

EPS17

Square shoulder endmills with ASMT/ASGT17 inserts

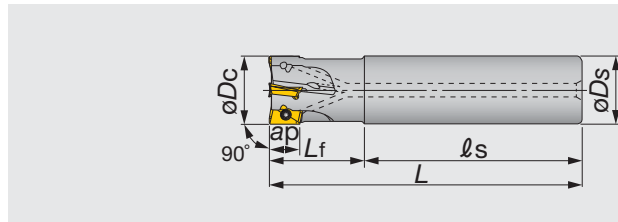

A.R. = +9° ~ +17°, R.R. = -20° ~ -7°



Right hand (R) shown.

Inch	Max. ap	ϕD_c	z	ϕD_s	ℓ_s	L_f	L	Air hole	Insert
EPS17100RSU	0.630	1.000	2	1.000	1.380	0.054	3.740	with	AS*T1705...
EPS17100RSU-3/4	0.630	1.000	2	0.750	1.380	0.054	3.740	with	AS*T1705...
EPS17125RSBU	0.630	1.250	2	1.250	1.380	0.054	3.740	with	AS*T1705...
EPS17150RSBU	0.630	1.500	2	1.250	1.380	0.054	3.740	with	AS*T1705...
EPS17100RLU	0.630	1.000	2	1.250	2.750	0.108	8.500	with	AS*T1705...
EPS17125RLU	0.630	1.250	3	1.250	3.000	0.118	10.000	with	AS*T1705...
EPS17150RLU	0.630	1.500	2	1.250	2.000	0.079	10.000	with	AS*T1705...

SPARE PARTS

Designation	Clamping screw	Lubricant	Wrench
EPS17...	CSPB-4S	M-1000	IP-15D

Reference pages

Inserts → D090, Standard cutting conditions → D091

INSERT

ASMT17-MJ

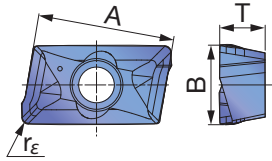

ASMT17-MS

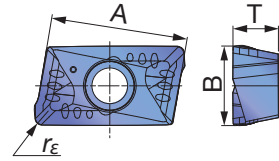

ASGT17-AJ

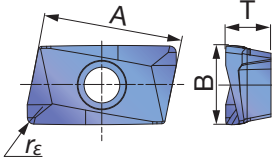

Shoulder Milling

P	Steel	★				★														
M	Stainless		★	★																
K	Cast iron	★			★															
N	Non-ferrous						★													
S	Superalloys	★	★																	
H	Hard materials																			

★ : First choice
☆ : Second choice

Designation	r _ε	Max. ap	Coated						Cermet	Un-coated	A	B	T			
			AH120	AH130	AH140	T1115	T3130	DS1100	NS740	KS05F						
ASMT170504PDPR-MJ	0.016	0.630	●	●		●	●		●					0.665	0.385	0.220
ASMT170508PDPR-MJ	0.031	0.630	●	●	●	●	●		●					0.665	0.385	0.220
ASMT170512PDPR-MJ	0.047	0.630	●	●			●							0.665	0.385	0.220
ASMT170516PDPR-MJ	0.062	0.630	●				●		●					0.665	0.385	0.220
ASMT170520PDPR-MJ	0.078	0.630	●						●					0.665	0.385	0.220
ASMT170530PDPR-MJ	0.118	0.630	●											0.665	0.385	0.220
ASMT170532PDPR-MJ	0.126	0.630	●				●		●					0.665	0.385	0.220
ASMT170508PDPR-MS	0.031	0.630		●	●									0.665	0.385	0.220
ASGT170504PDFR-AJ	0.016	0.630						●		●				0.665	0.385	0.220
ASGT170508PDFR-AJ	0.031	0.630						●		●				0.665	0.385	0.220

●: Line up

CAUTIONARY POINT IN MODIFYING CUTTER BODIES

When using inserts with corner radius $r_ε \geq 0.078"$, standard cutter bodies have to be modified "R".

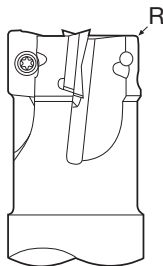

Corner radius r _ε (in)	The dimension of modifying (in)
0.016" ~ 0.062"	Unnecessary
0.078" ~ 0.126"	0.078

STANDARD CUTTING CONDITIONS

ISO	Workpiece material	Grade	Chip-breaker	Cutting speed Vc (sfm)			Feed per tooth fz (ipt)		
				Cutter dia. $\phi 0.472$	Cutter dia. $\phi 0.630, \phi 0.787$	Cutter dia. $> \phi 0.984$	Cutter dia. $\phi 0.472$	Cutter dia. $\phi 0.630, \phi 0.787$	Cutter dia. $> \phi 0.984$
P	Mild steel, Low Carbon steels (1018, 8620, etc.) < 180HB	NS740	MJ	260 ~ 330	330 ~ 400	330 ~ 500	0.002 ~ 0.003	0.002 ~ 0.005	0.002 ~ 0.006
		AH120	MJ	260 ~ 330	330 ~ 500	330 ~ 500	0.002 ~ 0.004	0.005 ~ 0.007	0.005 ~ 0.007
	Carbon steels, Alloy steels (1045, 1055, etc.) < 300HB	NS740	MJ	260 ~ 330	260 ~ 330	260 ~ 400	0.002 ~ 0.003	0.002 ~ 0.003	0.002 ~ 0.004
		T3130	MJ	260 ~ 330	260 ~ 400	330 ~ 650	0.002 ~ 0.004	0.004 ~ 0.006	0.004 ~ 0.007
	Die steels (SKD11, SKD61, etc.) < 300HB	T3130	MJ	260 ~ 330	260 ~ 400	330 ~ 500	0.002 ~ 0.004	0.004 ~ 0.006	0.005 ~ 0.007
M	Stainless steels (304, 316, etc.) < 250HB	AH130	MS	260 ~ 330	330 ~ 500	330 ~ 650	0.002 ~ 0.004	0.005 ~ 0.006	0.005 ~ 0.007
K	Grey Cast irons, Ductile Cast irons etc. (CLASS 25-40, 65-45-12, etc.)	T1115	MJ	260 ~ 330	330 ~ 500	330 ~ 650	0.003 ~ 0.005	0.005 ~ 0.007	0.006 ~ 0.010
N	Aluminum alloys (Si < 13%)	DS1100	AJ	980 ~ 3300	300 ~ 1000	300 ~ 1000	0.002 ~ 0.008	0.002 ~ 0.008	0.002 ~ 0.008
	Aluminum alloys (Si \geq 13%)	DS1100	AJ	330 ~ 650	330 ~ 650	330 ~ 650	0.002 ~ 0.008	0.002 ~ 0.008	0.002 ~ 0.008
	Copper alloys	KS05F	AJ	650 ~ 1650	650 ~ 1650	650 ~ 1650	0.002 ~ 0.008	0.002 ~ 0.008	0.002 ~ 0.008

- Notes:
- When using at L/D \geq 4, machining at the lower feed rate.
 - This TAC mill is not designed to cope with the centrifugal force and dynamic balance at high speeds over 1000 m/min. Therefore, the cutting speed in the outer diameter of the mill should not exceed 3300 sfm.

Shoulder Milling

APPLICATION RANGE

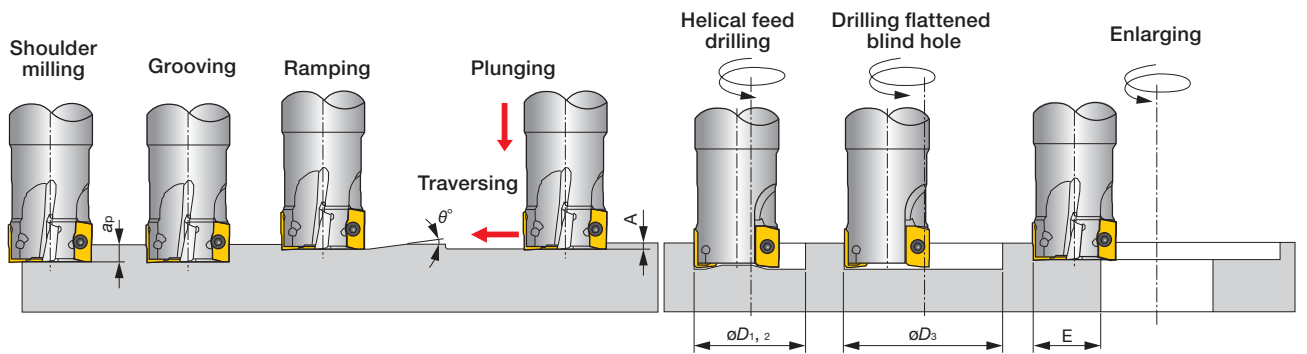

Inch	Tool ϕ	Max. depth of cut ap (in)	Max. ramping angle θ°	Max. plunging depth A	Min. machining hole dia. $\phi D1$	Max. machining hole dia. $\phi D2$	Hole dia. in drilling (Blind hole) $\phi D3$	Max. cutting width in enlarging hole E
EPS17100...	1.000	0.642	5°	0.039	1.260	1.890	1.810 ~ 1.890	0.945
EPS17125...	1.250	0.640	3.5°	0.039	1.810	2.440	2.360 ~ 2.440	1.220
EPS17150...	1.500	0.640	2.5°	0.039	2.440	3.070	2.990 ~ 3.070	1.540
TPS17200RBU	2.000	0.634	1.5°	0.039	3.230	3.860	3.780 ~ 3.850	1.930
TPS17300RBU	3.000	0.630	0.7°	0.039	5.590	6.220	6.140 ~ 6.220	3.110
TPS17400RBU	4.000	0.630	0.05°	0.039	7.170	7.800	7.720 ~ 7.800	3.900

Notes : Corner r_ϵ for dimensions of $\phi D1$, $\phi D2$, and $\phi D3$: $r_\epsilon = 0.031''$

TSE4000RIAU

Square shoulder mills with wedge clamped high-posi triangle inserts

A.R. = +17°, R.R. = +5°

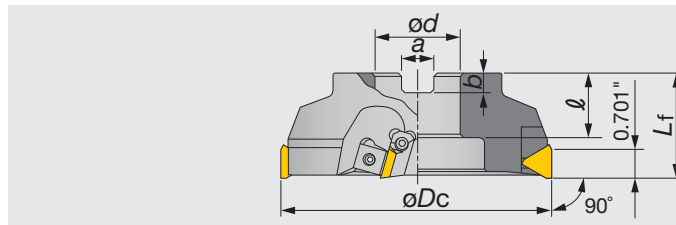

Right hand (R) shown.

Shoulder Milling

Inch	Max. ap	ϕD_c	z	L_f	ϕd	ℓ	a	b	lb
TSE4003RIAU	0.394	3.150	4	1.970	1.000	1.020	0.375	0.236	2.20
TSE4004RIAU	0.394	4.000	6	2.480	1.500	1.260	0.500	0.394	4.19
TSE4005RIAU	0.394	4.920	6	2.480	1.500	1.500	0.625	0.394	6.39
TSE4006RIAU	0.394	6.300	8	2.480	2.000	1.500	0.750	0.433	10.80
TSE4008RIA	0.394	7.870	10	2.480	2.500	1.500	1.000	0.551	16.31
TSE4010RIA	0.394	9.840	12	2.480	2.500	1.500	1.000	0.551	30.42
TSE4012RIA	0.394	12.400	14	2.480	2.500	1.500	1.000	0.551	48.72

SPARE PARTS

Designation	①Locator	②Wedge	③Wedge fixing screw	④Locator fixing screw	Wrench
TSE4003 - 4004...	LE403R	WF330N	FDS-8S	CM4X0.7X14	TP-4
TSE4005 - 4012...	LE405R	WF500R	FDS-8S	CM4X0.7X14	TP-4

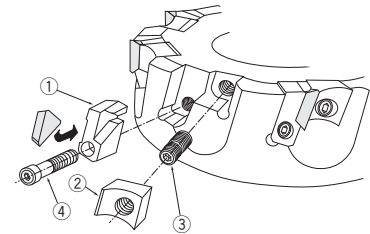

INSERT

TECN/TEEN 43Z

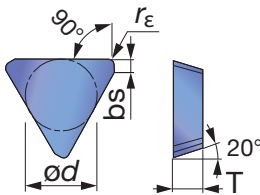

TECN43ZFR-DIA

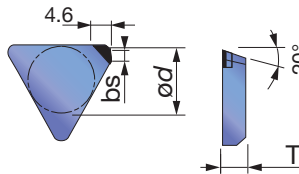

TEKR22-MS

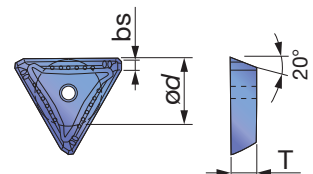

P Steel	★			☆	☆		★	★	☆										
M Stainless		★	★																
K Cast iron	★						★												
N Non-ferrous																			★
S Superalloys	★	☆																	★
H Hard materials																			

★ : First choice
☆ : Second choice

Designation	r_ϵ	Max. ap	Coated						Cermet		Uncoated		PCD	ϕd	T	bs	
			AH120	AH130	AH140	AH330	GH330	T1115	T3130	NS740	N308	UX30	TH10				DX140
TECN43ZFR	0.039	0.394													0.500	0.187	0.079
TECN43ZTR	0.039	0.394							●	●					0.500	0.187	0.052
TEEN43ZFR	0.039	0.394									●				0.500	0.187	0.079
TEEN43ZTR	0.039	0.394	●	●	●	●	●	●	●	●					0.500	0.187	0.052
TECN43ZFR-DIA	-	0.138											●		0.500	0.187	0.079
TEKR2204PEPR-MS	-	0.394			●										0.500	0.187	0.071

Note: T-DIA is trade name for Tungaloy's PCD grade. Available in one-corner type

● : Line up
DX140 : Packing Quantity = 1 pc.

Reference pages

Standard cutting conditions → **D093**

STANDARD CUTTING CONDITIONS

ISO	Workpiece materials	Grades	Roughing (Depth of cut ap: > 0.059")		Finishing (Depth of cut ap: 0.012" ~ 0.028")	
			Cutting speed vc (sfm)	Feed per tooth fz (ipt)	Cutting speed vc (sfm)	Feed per tooth fz (ipt)
P	Mild steels Unhardened steels (< 180 HB)	AH330	425 - 1200	0.004 - 0.008	150 - 400	0.004 - 0.009
		AH120, GH330	425 - 750	0.004 - 0.008	500 - 800	0.004 - 0.009
		T3130	425 - 980	0.004 - 0.009	590 - 980	0.004 - 0.010
		NS740, N308	425 - 650	0.004 - 0.007	500 - 800	0.004 - 0.008
		UX30, AH140	330 - 590	0.004 - 0.008	425 - 650	0.004 - 0.009
	Carbon steels Alloy steels (< 300 HB)	AH330	330 - 900	0.004 - 0.007	150 - 320	0.004 - 0.008
		AH120, GH330	330 - 590	0.004 - 0.008	500 - 650	0.004 - 0.008
		T3130	425 - 900	0.004 - 0.008	425 - 650	0.004 - 0.009
		AH140	260 - 425	0.004 - 0.007	330 - 650	0.004 - 0.007
		NS740, N308	330 - 500	0.004 - 0.006	500 - 650	0.004 - 0.007
		UX30	260 - 425	0.004 - 0.007	330 - 500	0.004 - 0.008
	Die steels (< 30 HRC)	AH330	330 - 800	0.004 - 0.006	330 - 800	0.004 - 0.008
T3130, AH120, GH330		330 - 500	0.004 - 0.006	330 - 500	0.004 - 0.008	
UX30		260 - 425	0.004 - 0.006	260 - 425	0.004 - 0.008	
M	Stainless steels (< 9.84 HB)	AH130, AH140	260 - 590	0.004 - 0.008	330 - 650	0.004 - 0.010
		AH120	500 - 650	0.004 - 0.007	650 - 820	0.004 - 0.010
K	Cast irons	T1115	330 - 650	0.004 - 0.008	330 - 650	0.004 - 0.010
	Ductile cast irons	TH10	260 - 425	0.004 - 0.008	260 - 425	0.004 - 0.010
N	Aluminum alloys (Si < 13%)	TH10	650 - 3300	0.002 - 0.010	350 - 1000	0.004 - 0.010
		DX140	650 - 3300	0.002 - 0.006	350 - 1000	0.004 - 0.008
	Copper alloys	TH10	650 - 1650	0.004 - 0.006	650 - 1650	0.004 - 0.008

Note: Dry cutting is recommended for all materials except for aluminum alloys.

Maximum depth of cut for TECN43ZFR-DIA is 0.138".

When wet machining mild steels, carbon steels and alloy steels, use T3130 at lower cutting conditions.



Shoulder Milling

TSP4000RIA-U

Square shoulder mills with wedge clamped 11° relief triangle inserts

A.R. = +5°, R.R. = 0°

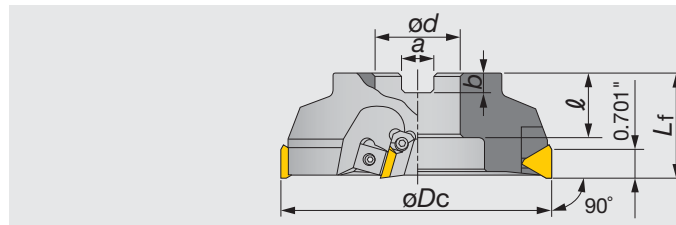

Right hand (R) shown.

Shoulder Milling

Inch	Max. ap	ϕD_c	z	Lf	ϕd	ℓ	a	b	lb
TSP4003RIA-U	0.394	3.150	4	1.970	1.000	1.020	0.375	0.236	2.43
TSP4004RIA-U	0.394	4.000	6	2.480	1.500	1.260	0.625	0.394	4.41
TSP4005RIA-U	0.394	4.920	6	2.480	1.500	1.500	0.625	0.394	6.83
TSP4006RIA-U	0.394	6.300	8	2.480	2.000	1.500	0.750	0.433	11.24
TSP4008RIA-U	0.394	7.870	10	2.480	2.500	1.500	1.000	0.551	16.98
TSP4010RIA	0.394	9.840	12	2.480	2.500	1.500	1.000	0.551	31.08
TSP4012RIA	0.394	12.400	14	2.480	2.500	1.500	1.000	0.551	49.82

SPARE PARTS

Designation	① Locator	② Wedge	③ Wedge fixing screw	④ Locator fixing screw	Wrench
TSP4003 - 4004...	LP403R	WF330N	FDS-8S	CM4X0.7X14	TP-4
TSP4005 - 4012...	LP405R	WF500R	FDS-8S	CM4X0.7X14	TP-4

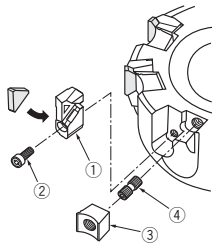

Reference pages

Inserts, Standard cutting conditions → **D095**

INSERT

TPCN/TPEN/TPKN 43Z

TPKR/TPMR-MJ

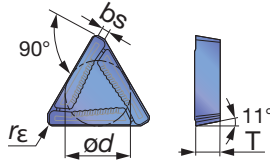
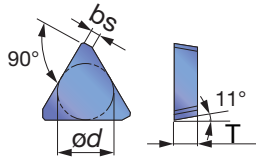

P Steel	★		☆	★	★	☆	☆						
M Stainless		★	★										
K Cast iron	★			★									
N Non-ferrous										★			
S Superalloys	★	☆											
H Hard materials													

★ : First choice
☆ : Second choice

Designation	rε	Max. ap	Coated						Cermet		Uncoated		ød	A	T	bs	
			AH120	AH130	AH140	GH330	T1115	T3130	NS740	N308	UX30	TH10					
TPCN43ZFR	-	0.394										●		0.500	-	0.187	0.079
TPCN43ZTR	-	0.394							●	●		●		0.500	-	0.187	0.079
TPEN43ZTR	-	0.394							●					0.500	-	0.187	0.079
TPEN43ZTRCR	-	0.394												0.500	-	0.187	0.079
TPKN43ZFR	-	0.394										●		0.500	-	0.187	0.079
TPKN43ZTR	-	0.394	●	●	●	●	●	●	●	●		●		0.500	-	0.187	0.079
TPKR43ZSR-MJ	-	0.394					●	●						0.500	-	0.187	0.059
TPMR2204PDSR-MJ	0.031	0.394					●	●						0.500	-	0.187	0.047

● : Line up

STANDARD CUTTING CONDITIONS

ISO	Workpiece materials	Grades	Roughing (Depth of cut ap: > 1.500")		Finishing (Depth of cut ap: 0.012" - 0.028")	
			Cutting speed vc (sfm)	Feed per tooth fz (ipt)	Cutting speed vc (sfm)	Feed per tooth fz (ipt)
P	Mild steels Unhardened steels (< 180 HB)	AH120, GH330	330 - 800	0.004 - 0.010	425 - 820	0.004 - 0.010
		T3130	425 - 980	0.004 - 0.011	590 - 980	0.004 - 0.012
		UX30	330 - 590	0.004 - 0.010	425 - 650	0.004 - 0.012
		NS740, N308	425 - 650	0.004 - 0.008	500 - 800	0.004 - 0.010
	Carbon steels Alloy steels (< 300 HB)	AH120, GH330	330 - 590	0.004 - 0.008	500 - 650	0.004 - 0.011
		T3130	425 - 650	0.004 - 0.010	425 - 650	0.004 - 0.011
UX30		260 - 425	0.004 - 0.008	330 - 500	0.004 - 0.011	
Die steels (< 30 HRC)	T3130, AH120, GH330	330 - 500	0.004 - 0.007	330 - 500	0.004 - 0.008	
	UX30	260 - 425	0.004 - 0.007	260 - 425	0.004 - 0.008	
M	Stainless steels (< 9.84 HB)	AH130, AH140	500 - 650	0.006 - 0.009	650 - 750	0.006 - 0.010
		AH120	500 - 750	0.006 - 0.008	650 - 820	0.006 - 0.009
K	Cast irons	T1115	330 - 650	0.004 - 0.008	330 - 650	0.004 - 0.010
	Ductile cast irons	TH10, UX30	260 - 425	0.004 - 0.008	260 - 425	0.004 - 0.010

Standard cutting conditions for Metal-Jack (MJ) inserts TPM/KR

ISO	Workpiece materials	Feed per tooth fz (ipt) (Roughing [Depth of cut: > 0.59"])	
		K: TPKR43ZSR-MJ	M: TPMR2204PDSR-MJ
P	Mild steels-Unhardened steels (< 180 HB)	0.004 - 0.009	0.004 - 0.016
	Carbon steels · Alloy steels (< 300 HB)	0.004 - 0.008	0.004 - 0.014
	Die steels (< 30 HRC)	0.004 - 0.007	0.004 - 0.010

Notes: Dry cutting is recommended for above materials.
When wet machining mild steels, carbon steels and alloy steels, use T3130 at lower cutting conditions.

Shoulder Milling

MillLine - Face Milling

						Inch	Metric
	DO TRIPLE MILL Face milling cutters with double-sided square, octagonal, and round inserts 45° $\phi 2.000'' - \phi 6.000''$ max. ap 0.236" P M K S H	D098	<input checked="" type="checkbox"/>	<input type="checkbox"/>			
	DO OCTO / DO QUAD Face milling cutters with screw-on and wedge clamping systems featuring 4 types of inserts for a broader application range 45° $\phi 2.480'' - \phi 12.402''$ max. ap 0.295" P M K S H	D101	<input checked="" type="checkbox"/>	<input type="checkbox"/>			
	DO PENT Economical, double-sided inserts with 10 cutting edges for general-purpose milling 70° $\phi 1.260'' - \phi 6.299''$ max. ap 0.252" P M K N S	D106	<input checked="" type="checkbox"/>	<input type="checkbox"/>			
	TUNG MILL Single-sided inserts with low cutting force for face milling 45° $\phi 0.984'' - \phi 6.299''$ max. ap 0.197" P M K N	D109	<input checked="" type="checkbox"/>	<input checked="" type="checkbox"/>			
	TFE / EFE Lightweight cutters with screw clamping system suitable for low-rigid machines 85° $\phi 2.000'' - \phi 4.000''$ max. ap 0.315" P M K N	D114	<input checked="" type="checkbox"/>	<input checked="" type="checkbox"/>			
	DPD / EDPD Lightweight cutters in wedge clamping design with PCD inserts 90° $\phi 80 - \phi 160 \text{ mm} / \phi 63 \text{ mm}$ max. ap 8 mm N	D117	<input type="checkbox"/>	<input checked="" type="checkbox"/>			
	ISO Milling 45° - TMD4400, TMD5400	D120	<input checked="" type="checkbox"/>	<input type="checkbox"/>			

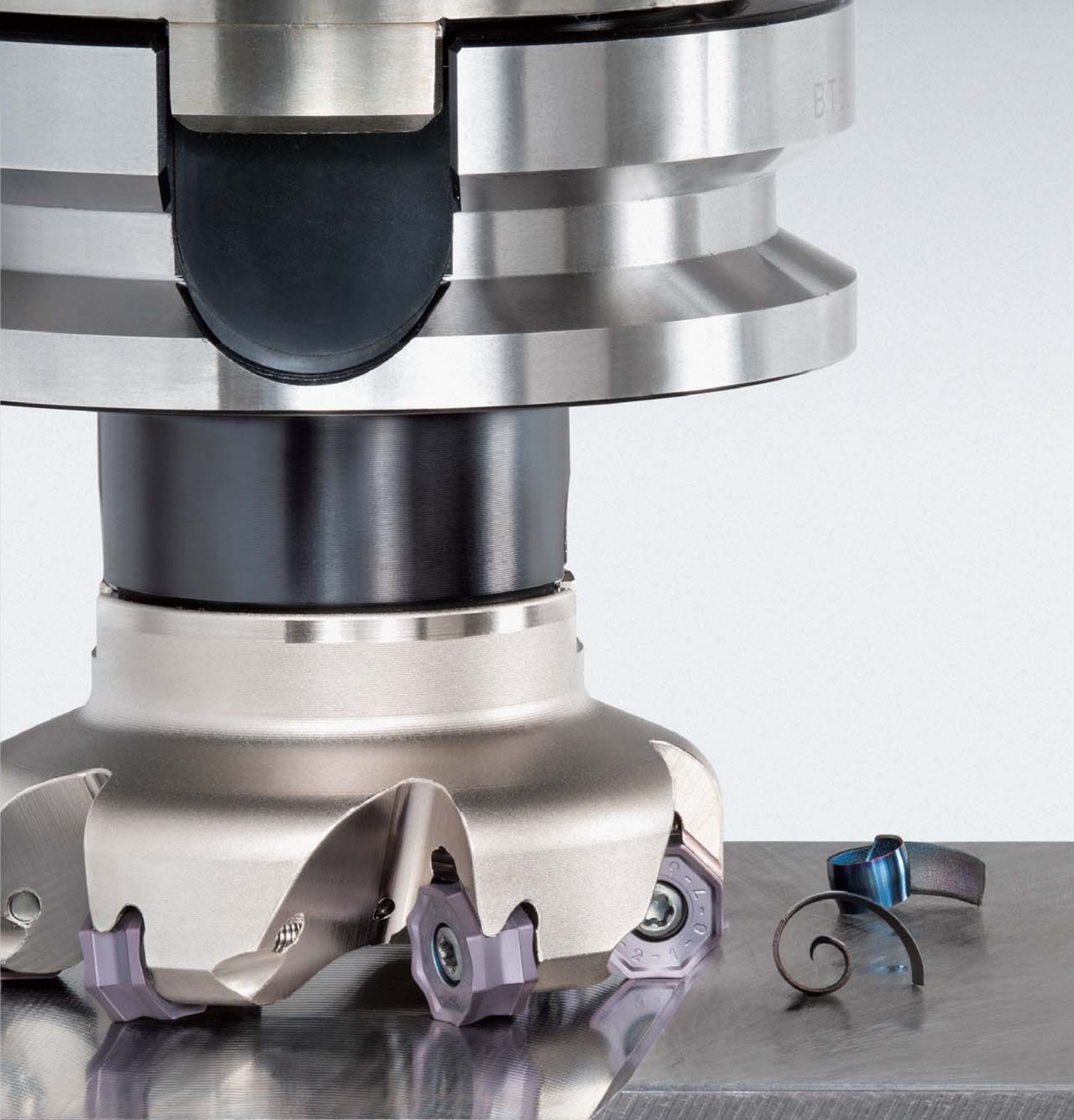

DoTriple-Mill

Tungaloy D097

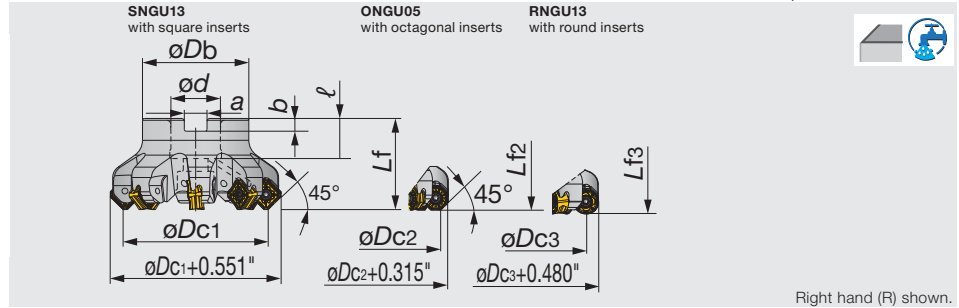

Inch	øDc1	øDc2	øDc3	z	øDb	Lf1	Lf2	Lf3	ød	ℓ	a	b	lb	Air hole
TASN13U2.00B0.75R05	2.000	2.118	1.982	5	1.850	1.575	1.516	1.517	0.750	0.750	0.315	0.197	0.900	with
TASN13U2.50B0.75R06	2.500	2.618	2.482	6	1.850	1.575	1.516	1.517	0.750	0.750	0.315	0.197	1.320	with
TASN13U2.50B0.75R08	2.500	2.618	2.482	8	1.850	1.575	1.516	1.517	0.750	0.750	0.315	0.197	1.540	with
TASN13U3.00B1.00R08	3.000	3.118	2.982	8	1.969	1.969	1.909	1.911	1.000	1.024	0.374	0.236	1.980	with
TASN13U3.00B1.00R10	3.000	3.118	2.982	10	1.969	1.969	1.909	1.911	1.000	1.024	0.374	0.236	2.200	with
TASN13U4.00B1.50R08	4.000	4.118	3.982	8	3.150	1.969	1.909	1.911	1.500	1.276	0.626	0.394	3.750	without
TASN13U4.00B1.50R12	4.000	4.118	3.982	12	3.150	1.969	1.909	1.911	1.500	1.276	0.626	0.394	3.750	without
TASN13U5.00B1.50R10	5.000	5.118	4.982	10	3.150	2.480	2.421	2.422	1.500	1.378	0.626	0.394	5.950	without
TASN13U5.00B1.50R14	5.000	5.118	4.982	14	3.150	2.480	2.421	2.422	1.500	1.378	0.626	0.394	6.720	without
TASN13U6.00B2.00R12	6.000	6.118	5.982	12	3.937	2.480	2.421	2.422	2.000	1.496	0.748	0.433	8.600	without

Face Milling

SPARE PARTS

Designation	Clamping screw	Grip	Lubricant	Center bolt (Optional parts)	Center bolt 1 (Optional parts)	Torx bit
TASN13... (øDc1 < 3.0")	CSPB-4	H-TB2W	M-1000	-	(C0.375X1.125H)	BLDIP15/S7
TASN13... (øDc1 = 3.0")	CSPB-4	H-TB2W	M-1000	-	(C0.500X1.375H)	BLDIP15/S7
TASN13... (øDc1 = 4.0")	CSPB-4	H-TB2W	M-1000	(TMBA-0.750H)	-	BLDIP15/S7
TASN13... (øDc1 = 5.0")	CSPB-4	H-TB2W	M-1000	(TMBA-0.750H)	-	BLDIP15/M7
TASN13... (øDc1 = 6.0")	CSPB-4	H-TB2W	M-1000	-	-	BLDIP15/M7

Reference pages

Inserts → **D099**, Standard cutting conditions → **D100**

INSERT

SNMU-MJ

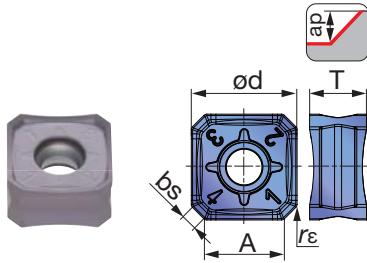

SNGU-MJ

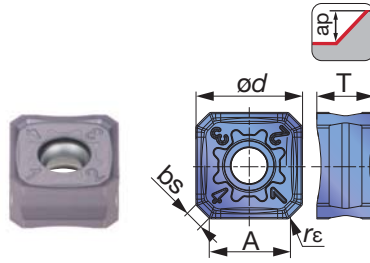

SNGU-MH

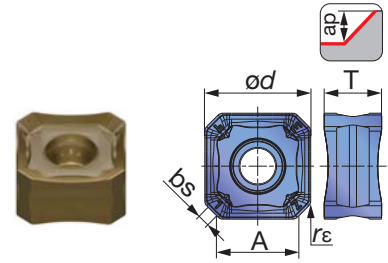

SNGU-W

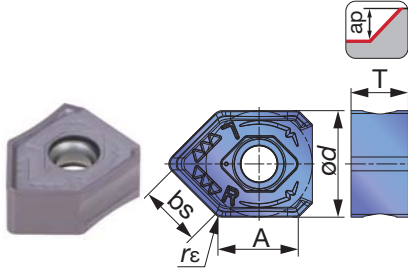

ONMU-MJ

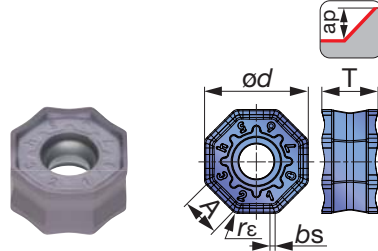

ONGU-MJ

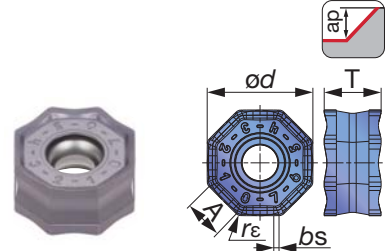

ONGU-W

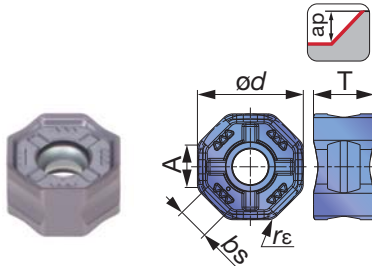

RNMU-MJ

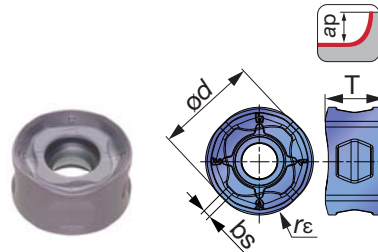

RNGU-MJ

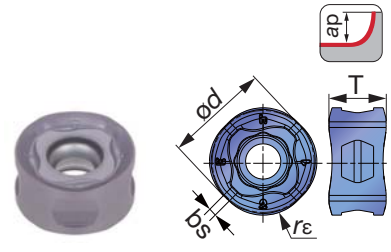

SNGU#C-MJ

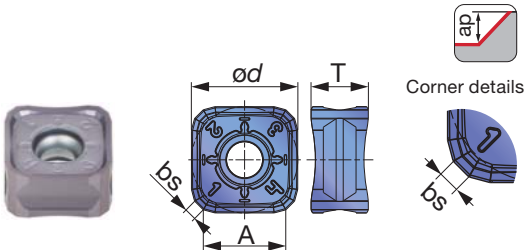

P	Steel	☆	★	★	
M	Stainless		★	★	
K	Cast iron	★			★
N	Non-ferrous				
S	Superalloys	★	☆		
H	Hard materials				

★ : First choice
☆ : Second choice

Designation	rε	Max. ap	Coated				A	ød	T	bs
			AH120	AH3135	T3225	T1215				
SNMU1307ANEN-MJ	0.020	0.236	●	●	●	●	0.370	0.512	0.276	0.079
SNGU1307ANEN-MJ	0.020	0.236	●	●	●		0.370	0.512	0.276	0.079
SNGU1307ANEN-MH	0.031	0.236			●		0.354	0.512	0.276	0.079
SNGU1307ANEN-W	0.047	0.236	●	●			0.378	0.512	0.276	0.295
ONMU0507ANEN-MJ	0.031	0.134	●	●	●	●	0.193	0.512	0.276	0.028
ONGU0507ANEN-MJ	0.031	0.134	●	●	●		0.193	0.512	0.276	0.028
ONGU0507ANEN-W	0.063	0.134	●	●			0.197	0.512	0.293	0.154
RNMU1307ZNER-MJ	0.236	0.236	●	●	●	●	-	0.512	0.280	0.039
RNGU1307ZNER-MJ	0.236	0.236	●	●			-	0.512	0.280	0.039
SNGU1307C14ANEN-MJ	-	0.236	●	●			0.343	0.512	0.276	0.055

● : Line up

Face Milling

STANDARD CUTTING CONDITIONS

SNMU / SNGU / ONMU / ONGU

ISO	Workpiece materials	Hardness	Priority	Grades	Chip-breaker	Cutting speed Vc (sfm)	Feed per tooth fz (ipt)	
P	Low carbon steel (1015, 1020, etc.)	200 - 300HB	First choice	AH3135	MJ	330 - 980	0.004 - 0.020	
			For wear resistance	T3225	MJ	660 - 1150	0.004 - 0.016	
	High carbon and alloy steel (1055, 4140, etc.)	150 - 300HB	First choice	AH3135	MJ	330 - 820	0.004 - 0.016	
			For wear resistance	T3225	MJ	590 - 980	0.004 - 0.016	
	Prehardened steel (NAK80, PX5, etc.)	30 - 40HRC	First choice	AH3135	MJ	330 - 660	0.004 - 0.016	
			For wear resistance	T3225	MJ	490 - 820	0.004 - 0.016	
M	Stainless steel (304SS, 316SS, etc.)	- 200HB	First choice	AH3135	MJ	330 - 660	0.004 - 0.014	
			For wear resistance	T3225	MJ	330 - 820	0.004 - 0.012	
	Stainless cast steel (1.4849, etc.)	-	First choice	T3225	MH	200 - 390	0.004 - 0.012	
For low cutting force			AH3135	MJ	200 - 390	0.004 - 0.012		
K	Gray cast iron (Class 25, Class 30, etc.)	150 - 250 HB	First choice	T1215	MJ	330 - 980	0.004 - 0.016	
				AH120	MJ	330 - 820	0.004 - 0.020	
	Ductile cast iron (60-40-18, 80-55-06, etc.)	150 - 250 HB	First choice	T1215	MJ	330 - 980	0.004 - 0.016	
				AH120	MJ	260 - 660	0.004 - 0.020	
S	Titanium alloys (Ti-6Al-4V, etc.)	- 40HRC	First choice	AH3135	MJ	100 - 200	0.004 - 0.012	
	Heat-resistant alloys (Inconel718, etc.)	- 40HRC	First choice	AH120	MJ	30 - 130	0.002 - 0.006	
H	Hardened steel	(H13, etc.)	40 - 50 HRC	First choice	AH3135	MJ	260 - 430	0.004 - 0.008
		(D2, etc.)	50 - 60 HRC	First choice	AH120	MJ	160 - 230	0.001 - 0.004

Face Milling

RNMU / RNGU

ISO	Workpiece materials	Hardness	Priority	Grades	Chip-breaker	Cutting speed Vc (sfm)	Feed per tooth fz (ipt)	
P	Low carbon steel (1015, 1020, etc.)	200 - 300 HB	First choice	AH3135	MJ	330 - 980		
			For wear resistance	T3225	MJ	660 - 1150		
	High carbon and alloy steel (1055, 4140, etc.)	150 - 300 HB	First choice	AH3135	MJ	330 - 820	※ap = 0.236": 0.004 - 0.012	
			For wear resistance	T3225	MJ	590 - 980	※ap = 0.078": 0.016 - 0.031 ※ap = 0.039": 0.031 - 0.059	
	Prehardened steel (NAK80, PX5, etc.)	30 - 40 HRC	First choice	AH3135	MJ	330 - 660		
			For wear resistance	T3225	MJ	490 - 820		
M	Stainless steel (304SS, 316SS, etc.)	- 200 HB	First choice	AH3135	MJ	330 - 660	※ap = 0.236": 0.004 - 0.010	
			For wear resistance	T3225	MJ	330 - 820	※ap = 0.078": 0.012 - 0.027 ※ap = 0.039": 0.024 - 0.051	
	Stainless cast steel (1.4849, etc.)	-	First choice	T3225	MJ	200 - 390	※ap = 0.078": 0.008 - 0.016	
For fracture resistance			AH3135	MJ	200 - 390	※ap = 0.039": 0.012 - 0.031		
K	Gray cast iron (Class 25, Class 30, etc.)	150 - 250 HB	First choice	AH120	MJ	330 - 980		
				T1215	MJ	330 - 820	※ap = 0.236": 0.004 - 0.012 ※ap = 0.078": 0.016 - 0.031 ※ap = 0.039": 0.031 - 0.059	
	Ductile cast iron (60-40-18, 80-55-06, etc.)	150 - 250 HB	First choice	AH120	MJ	330 - 980		
				T1215	MJ	260 - 660		
S	Titanium alloys (Ti-6Al-4V, etc.)	- 40 HRC	First choice	AH3135	MJ	100 - 200	ap = 0.039": 0.006 - 0.031	
	Heat-resistant alloys (Inconel718, etc.)	- 40 HRC	First choice	AH120	MJ	30 - 130	ap = 0.039": 0.002 - 0.012	
H	Hardened steel	(H13, etc.)	40 - 50 HRC	First choice	AH3135	MJ	260 - 430	ap = 0.039": 0.004 - 0.010
		(D2, etc.)	50 - 60 HRC	First choice	AH120	MJ	160 - 230	ap = 0.020": 0.001 - 0.004

※When using T3225 or T1215, decrease the feed per tooth (fz) to 80% of the abovementioned value.

A.R.= -6°, R.R.= +15.5°

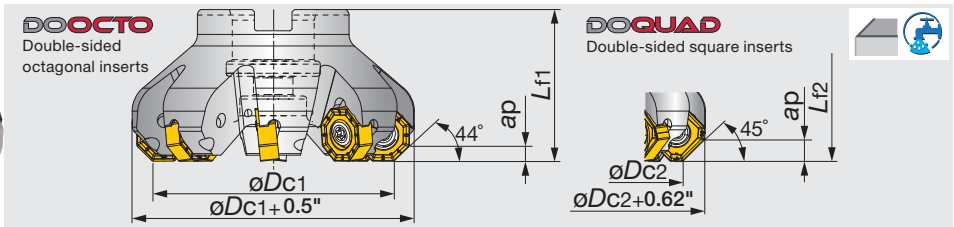

Inch	ϕD_{c1}	ϕD_{c2}	z	ϕD_b	Lf1	Lf2	ϕd	ℓ	a	b	lb	Air hole	Insert	Arbor type
TAN07R250U0075A05	2.500	2.394	5	1.750	1.750	1.805	0.750	0.750	0.313	0.188	1	with	SN°U/ON°U/OWMT...	A
TAN07R250U0075A06	2.500	2.394	6	1.750	1.750	1.805	0.750	0.750	0.313	0.188	1	with	SN°U/ON°U/OWMT...	A
TAN07R300U0100A06	3.000	2.894	6	2.000	2.000	2.055	1.000	0.750	0.375	0.219	2	with	SN°U/ON°U/OWMT...	A
TAN07R300U0100A08	3.000	2.894	8	2.000	2.000	2.055	1.000	0.750	0.375	0.219	2	with	SN°U/ON°U/OWMT...	A
TAN07R400U0150A07	4.000	3.894	7	2.400	2.000	2.055	1.500	1.000	0.625	0.375	3	with	SN°U/ON°U/OWMT...	A
TAN07R400U0150A10	4.000	3.894	10	2.400	2.000	2.055	1.500	1.000	0.625	0.375	3	with	SN°U/ON°U/OWMT...	A
TAN07R500U0150A08	5.000	4.894	8	2.400	2.500	2.555	1.500	1.000	0.625	0.375	5	with	SN°U/ON°U/OWMT...	B
TAN07R500U0150A12	5.000	4.894	12	2.400	2.500	2.555	1.500	1.000	0.625	0.375	5	with	SN°U/ON°U/OWMT...	B
TAN07R600U0200A10	6.000	5.894	10	4.000	2.500	2.555	2.000	1.000	0.750	0.438	7	without	SN°U/ON°U/OWMT...	B
TAN07R600U0200A15	6.000	5.894	15	4.000	2.500	2.555	2.000	1.000	0.750	0.438	7	without	SN°U/ON°U/OWMT...	B
TAN07R800U0250A12	8.000	7.894	12	5.300	2.500	2.555	2.500	1.400	1.000	0.531	13	without	SN°U/ON°U/OWMT...	C
TAN07R800U0250A18	8.000	7.894	18	5.300	2.500	2.555	2.500	1.400	1.000	0.531	13	without	SN°U/ON°U/OWMT...	C

Arbor type

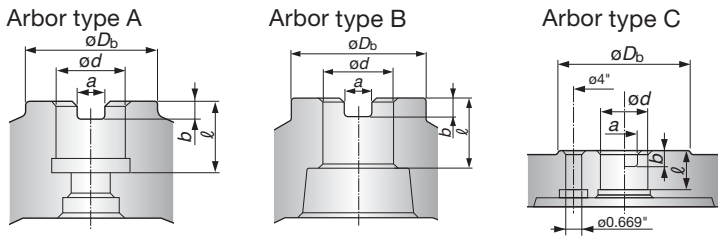

SPARE PARTS

Designation	Clamping screw	Grip	Torx bit	Center bolt (Optional parts)	Center bolt 1 (Optional parts)
TAN07R250...	SRM5X0.8IP20X+ACROLYTE	H-TB	BLDIP20/S7	-	(C0.375X1.125H)
TAN07R300...	SRM5X0.8IP20X+ACROLYTE	H-TB	BLDIP20/S7	-	(C0.500X1.375H)
TAN07R400, 500...	SRM5X0.8IP20X+ACROLYTE	H-TB	BLDIP20/S7	(TMBA-0.750H)	-
TAN07R600, 800...	SRM5X0.8IP20X+ACROLYTE	H-TB	BLDIP20/S7	-	-



Reference pages

Inserts → **D104**, Standard cutting conditions → **D105**

Screw-on type



Cutter diameter and height with single sided octagonal insert

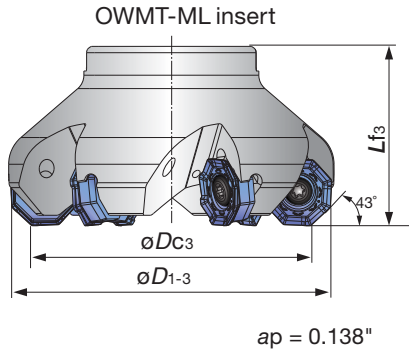

OWMT-HJ insert

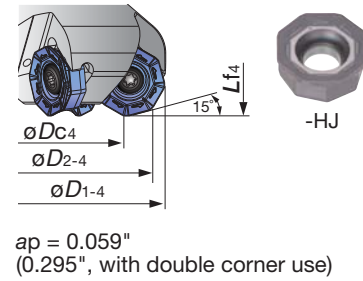

Inch	Dimensions (in)						
	$\phi Dc3$	$\phi D1-3$	$\phi Dc4$	$\phi D2-4$	$\phi D1-4$	$Lf3$	$Lf4$
TAN07R250U0075A..	2.520	2.213	3.000	2.665	3.028	1.789	1.805
TAN07R300U0100A..	3.020	2.713	3.500	3.165	3.528	2.039	2.055
TAN07R400U0150A..	4.020	3.713	4.500	4.165	4.528	2.039	2.055
TAN07R500U0150A..	5.020	4.713	5.500	5.165	5.528	2.539	2.555
TAN07R600U0200A..	6.020	5.713	6.500	6.165	6.528	2.539	2.555
TAN07R800U0250A..	8.020	7.713	8.500	8.165	8.528	2.539	2.555

Note: OWMT08 inserts can be only used with screw on type cutters.

TAN07-W

45° wedge clamp type face mills with double sided octagonal or square inserts.

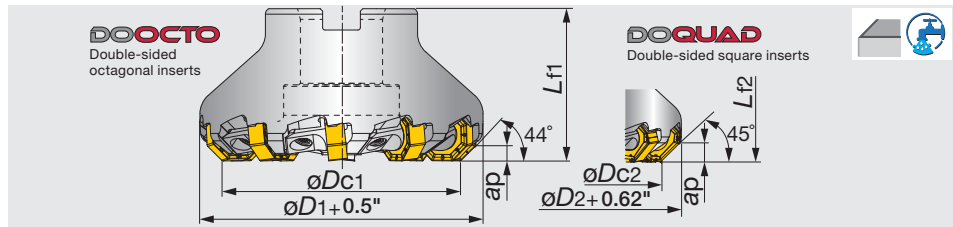

Inch	$\phi Dc1$	$\phi Dc2$	z	ϕDb	Lf1	Lf2	ϕd	ℓ	a	b	lb	Air hole	Insert	Arbor type
TAN07R250U0075A08W	2.500	2.394	8	1.750	1.750	1.805	0.750	0.750	0.313	0.188	1.60	without	SN*U/ON*U/OWMT...	B
TAN07R300U0100A10W	3.000	2.894	10	2.000	2.000	2.055	1.000	0.750	0.375	0.219	2.00	with	SN*U/ON*U/OWMT...	B
TAN07R400U0150A14W	4.000	3.894	14	2.400	2.000	2.055	1.500	1.000	0.625	0.375	2.80	without	SN*U/ON*U/OWMT...	B
TAN07R500U0150A18W	5.000	4.894	18	2.400	2.500	2.555	1.500	1.000	0.625	0.375	4.30	with	SN*U/ON*U/OWMT...	B
TAN07R600U0200A22W	6.000	5.894	22	4.000	2.500	2.555	2.000	1.000	0.750	0.438	6.80	without	SN*U/ON*U/OWMT...	B
TAN07R800U0250A28W	8.000	7.894	28	5.300	2.500	2.555	2.500	1.400	1.000	0.531	13.50	with	SN*U/ON*U/OWMT...	C

Arbor type

Arbor type B

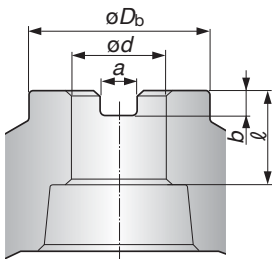

Arbor type C

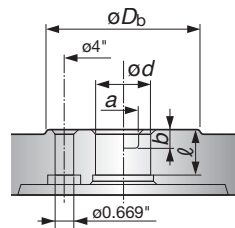

SPARE PARTS

Designation	Grip	Torx bit	Wedge	Clamping screw	Center bolt (Optional parts)
TAN07R250U0075A08W	H-TBS	BLDIP15/S7	CL ARM-10-TUNG1	DS-6P	(C0.375X1.125H)
TAN07R300U - 800U**W	H-TBS	BLDIP15/S7	CL ARM-10-TUNG1	DS-6P	-



Reference pages

Inserts → **D104**, Standard cutting conditions → **D105**

Face Milling

INSERT

ONMU/ONHU0705-MJ / -ML

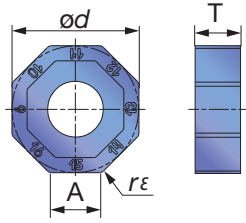

ONHU0705-W

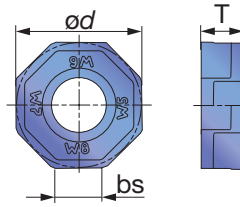

OWMT0807-HJ

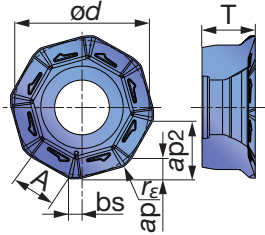

OWMT0807-ML

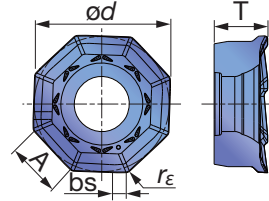

SNMU/SNHU1706 -MJ / -ML

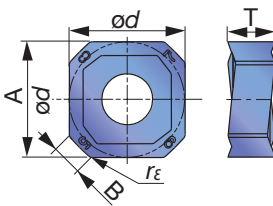

SNHU1706-W

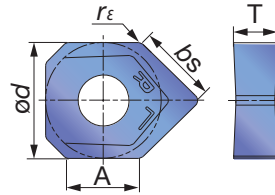

Face Milling

P Steel	☆			★	★						
M Stainless		★	☆	☆	★						
K Cast iron	★			☆		★	★				
N Non-ferrous											
S Superalloys	★	☆		★	☆						
H Hard materials											

★ : First choice
☆ : Second choice

Designation	rε	Max. ap	Coated						ød	T	B	ød	bs	Max. ap ² .
			AH120	AH130	AH140	AH725	AH3135	T1115						
ONMU0705ANPN-MJ	0.031	0.187			●	●	●	●	0.283	0.244	-	0.681	-	-
ONMU0705ANPN-ML	0.031	0.187	●				●	0.283	0.244	-	0.681	-	-	
ONHU0705ANPN-MJ	0.031	0.187			●	●		0.283	0.244	-	0.681	-	-	
ONHU0705ANTN-ML	0.031	0.187	●		●	●		0.283	0.244	-	0.681	-	-	
ONHU0705ANPR-W *	-	0.187	●					0.283	0.228	-	0.689	0.252	-	
OWMT0807ZNER-HJ	0.031	0.059					●	-	0.291	-	0.748	0.039	0.295	
OWMT0807AAER-ML	0.047	0.138		●			●	0.205	0.291	-	-	0.047	-	
SNMU1706ANPR-MJ	0.031	0.295			●	●	●	●	0.433	0.275	0.173	0.681	0.709	-
SNMU1706ANTR-ML	0.031	0.295	●				●	0.433	0.275	0.173	0.681	0.709	-	
SNHU1706ANPR-MJ	0.031	0.295			●	●		0.433	0.275	0.173	0.681	0.709	-	
SNHU1706ANTR-ML	0.031	0.295	●					0.433	0.275	0.173	0.681	0.709	-	
SNHU1706ANFN-W *	0.016	0.295	●					0.681	0.256	-	0.681	0.433	-	

* Pay attention to the wiper insert installation procedure below.

● : Line up

Attention for wiper inserts

DOOCTO

1
2

Attach only one wiper insert on the cutter and make sure the wiper edge faces the machining surface.
Feed rate: $f < 0.217$ ipr

DOQUAD

1
2

Attach only one insert on the cutter and make sure the wiper edge faces the machining surface.
Feed rate: $f < 0.374$ ipr

STANDARD CUTTING CONDITIONS

Double-sided inserts

ISO	Workpiece material	Hardness	Priority	Recommendation		Cutting speed Vc (sfm)	Feed per tooth fz (ipt)
				Grade	Chipbreaker		
P	Low carbon steel 1015, etc.	- 200 HB	First choice	AH3135	ML	330 - 980	0.008 - 0.020
		- 200 HB	For wear resistance	AH725	ML	330 - 980	0.008 - 0.020
		- 200 HB	For fracture resistance	AH140	MJ	260 - 590	0.008 - 0.020
	High carbon steel 1045, 1055, etc.	200 - 300 HB	First choice	AH3135	MJ	230 - 750	0.008 - 0.016
		200 - 300 HB	For wear resistance	AH725	MJ	230 - 750	0.008 - 0.016
		200 - 300 HB	For fracture resistance	AH140	MJ	260 - 590	0.008 - 0.016
	Alloy steel 4140, etc.	150 - 330 HB	First choice	AH3135	MJ	330 - 660	0.008 - 0.016
		150 - 330 HB	For wear resistance	AH725	MJ	330 - 660	0.008 - 0.016
		150 - 330 HB	For fracture resistance	AH140	MJ	260 - 490	0.008 - 0.016
M	Stainless steel S30400, etc.	- 200 HB	First choice	AH3135	ML	100 - 150	0.004 - 0.012
K	Gray cast iron No.35B, No.45B, etc.	150 - 250 HB	First choice	AH120	ML	330 - 820	0.004 - 0.020
		150 - 250 HB	For fracture resistance	AH725	MJ	330 - 820	0.004 - 0.020
		150 - 250 HB	For wear resistance	T1215	MJ	490 - 980	0.004 - 0.020
	Ductile cast iron 60-40-18, etc.	150 - 300HB	First choice	AH120	ML	260 - 660	0.004 - 0.016
		150 - 300 HB	For fracture resistance	AH725	MJ	260 - 660	0.004 - 0.016
		150 - 300 HB	For wear resistance	T1215	MJ	330 - 820	0.004 - 0.016
H	Hardened steel	HRC 40 - 50	First choice	AH3135	MJ	260 - 430	0.004 - 0.008
		HRC 50 - 60	First choice	AH3135	MJ	160 - 230	0.002 - 0.004



Face Milling

Single-sided inserts

ISO	Workpiece material	Hardness	Priority	Grade	Cutting speed Vc (sfm)	Feed per tooth: fz (ipt)	
						ML	HJ*
P	Low carbon steel 1015, etc.	- 200	First choice	AH3135	330 - 980	0.004 - 0.020	0.02 - 0.079
		- 200	For fracture resistance	AH130	330 - 980	0.004 - 0.020	-
	High carbon steel 1045, 1055, etc.	200 - 300 HB	First choice	AH3135	330 - 750	0.004 - 0.016	0.02 - 0.059
		200 - 300 HB	For fracture resistance	AH130	330 - 750	0.004 - 0.016	-
	Alloy steel 4140, etc.	150 - 330 HB	First choice	AH3135	330 - 660	0.004 - 0.016	0.02 - 0.059
		150 - 330 HB	For fracture resistance	AH130	330 - 660	0.004 - 0.016	-
M	Stainless steel S30400, etc.	- 200 HB	First choice	AH3135	330 - 500	0.004 - 0.010	0.012 - 0.02
		- 200 HB	For fracture resistance	AH130	330 - 500	0.004 - 0.010	-
K	Gray cast iron No.35B, No.45B, etc.	150 - 250 HB	First choice	AH3135	330 - 830	0.004 - 0.020	0.02 - 0.079
		150 - 250 HB	For fracture resistance	AH130	330 - 830	0.004 - 0.020	-
	Ductile cast iron 60-40-18, etc.	150 - 250 HB	First choice	AH3135	260 - 660	0.004 - 0.020	0.02 - 0.059
		150 - 250 HB	For fracture resistance	AH130	260 - 660	0.004 - 0.020	-
S	Titanium alloy Ti-6Al-4V, etc.	- HRC 40	First choice	AH3135	100 - 200	0.004 - 0.012	0.012 - 0.028
		- HRC 40	For fracture resistance	AH130	100 - 200	0.004 - 0.012	-
	Heat resistant alloy Inconel718, etc.	- HRC 40	First choice	AH3135	30 - 130	0.002 - 0.006	0.004 - 0.012
		- HRC 40	For fracture resistance	AH130	30 - 130	0.002 - 0.006	-
H	Hardened steel	HRC 40 - 50	First choice	AH3135	260 - 420	-	0.004 - 0.012
		HRC 50 - 60	First choice	AH3135	160 - 230	-	0.001 - 0.003

* Apply 20% of recommended feed when using HJ insert with ap over 0.591".

70° face mills with double sided pentagonal inserts.

A.R.=-6°,R.R.=-10°~-2°

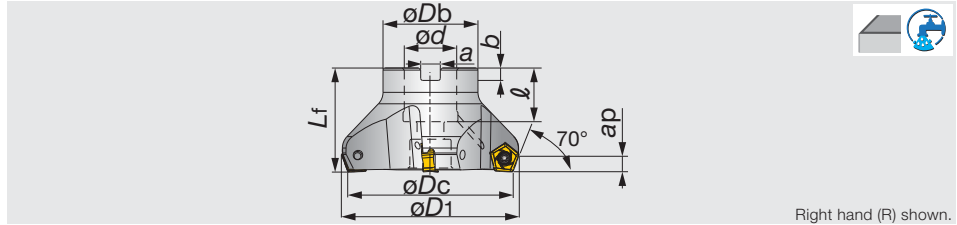
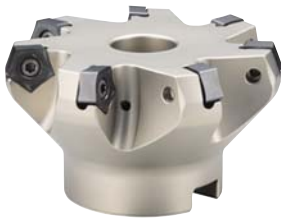

Face Milling

Inch	Max. ap	ϕDc	z	$\phi D1$	ϕDb	L_f	ϕd	ℓ	a	b	lb	Air hole	Insert
TEN09R200U0075A03	0.252	2.000	3	2.240	1.690	1.570	0.750	0.750	0.310	0.200	0.300	with	PN*U0905...
TEN09R200U0075A04	0.252	2.000	4	2.240	1.690	1.570	0.750	0.750	0.310	0.200	0.300	with	PN*U0905...
TEN09R200U0075A06	0.252	2.000	6	2.240	1.690	1.570	0.750	0.750	0.310	0.200	0.300	with	PN*U0905...
TEN09R250U0075A04	0.252	2.500	4	2.740	1.690	1.570	0.750	0.750	0.310	0.200	0.500	with	PN*U0905...
TEN09R250U0075A06	0.252	2.500	6	2.740	1.690	1.570	0.750	0.750	0.310	0.200	0.500	with	PN*U0905...
TEN09R250U0075A08	0.252	2.500	8	2.740	1.690	1.570	0.750	0.750	0.310	0.200	0.500	with	PN*U0905...
TEN09R300U0100A04	0.252	3.000	4	3.240	1.970	1.970	1.000	1.020	0.370	0.240	0.900	with	PN*U0905...
TEN09R300U0100A07	0.252	3.000	7	3.240	1.970	1.970	1.000	1.020	0.370	0.240	0.900	with	PN*U0905...
TEN09R300U0100A10	0.252	3.000	10	3.240	1.970	1.970	1.000	1.020	0.370	0.240	0.900	with	PN*U0905...
TEN09R400U0150A05	0.252	4.000	5	4.240	3.150	1.970	1.500	1.380	0.630	0.390	1.300	with	PN*U0905...
TEN09R400U0150A08	0.252	4.000	8	4.240	3.150	1.970	1.500	1.380	0.630	0.390	1.300	with	PN*U0905...
TEN09R400U0150A12	0.252	4.000	12	4.240	3.150	1.970	1.500	1.380	0.630	0.390	1.400	with	PN*U0905...
TEN09R500U0150A06	0.252	5.000	6	5.240	3.150	2.480	1.500	1.460	0.630	0.390	2.600	with	PN*U0905...
TEN09R500U0150A10	0.252	5.000	10	5.240	3.150	2.480	1.500	1.460	0.630	0.390	2.700	with	PN*U0905...
TEN09R500U0150A16	0.252	5.000	16	5.240	3.150	2.480	1.500	1.460	0.630	0.390	2.900	with	PN*U0905...
TEN09R600U0200A07	0.252	6.000	7	6.240	3.940	2.480	2.000	1.500	0.750	0.430	4.400	without	PN*U0905...
TEN09R600U0200A12	0.252	6.000	12	6.240	3.940	2.480	2.000	1.500	0.750	0.430	4.600	without	PN*U0905...
TEN09R600U0200A20	0.252	6.000	20	6.240	3.940	2.480	2.000	1.500	0.750	0.430	4.900	without	PN*U0905...

SPARE PARTS

Designation	Clamping screw	Grip	Lubricant	Center bolt (Optional parts)	Center bolt 1 (Optional parts)	Torx bit
TEN09R200, 250...	CSTR-4L100	H-TBS	M-1000	-	(C0.375X1.125H)	BT15S
TEN09R300...	CSTR-4L100	H-TBS	M-1000	-	(C0.500X1.375H)	BT15S
TEN09R400, 500...	CSTR-4L100	H-TBS	M-1000	(TMBA-0.750H)	-	BT15S
TEN09R600...	CSTR-4L100	H-TBS	M-1000	-	-	BT15M

Reference pages

Inserts → **D107**, Standard cutting conditions → **D108**

EEN09

70° endmills with double sided pentagonal inserts.

A.R.=-6°,R.R.=-2°~10°

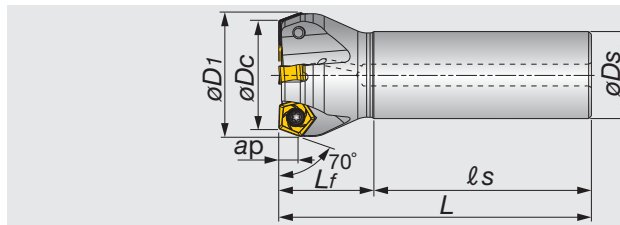

Inch	Max. ap	ϕD_c	z	ϕD_1	ϕD_s	l_s	L_f	L	lb	Air hole	Insert
EEN09R125U0125W03	0.252	1.250	3	1.250	1.250	2.280	1.500	3.780	0.700	with	PN*U0905...
EEN09R150U0125W04	0.252	1.500	4	1.500	1.250	2.280	2.000	4.280	0.700	with	PN*U0905...

SPARE PARTS



Designation	Clamping screw	Lubricant	Wrench
EEN09...	CSTR-4L100	M-1000	T-15D

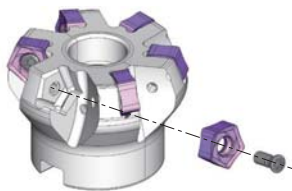

Face Milling

INSERT

PNCU0905-MJ (Right-hand)

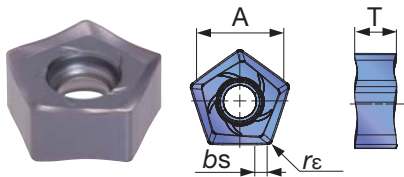

PNCU0905-ML (Neutral-hand)

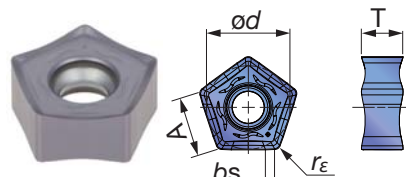

PNCU0905-AJ (Right-hand)

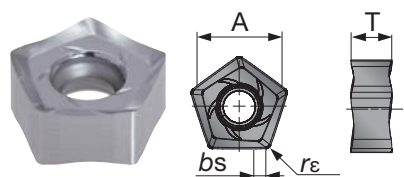

PNMU0905-MJ (Neutral-hand)

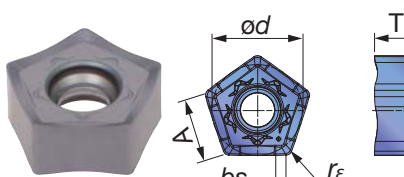

PNCU0905-W (Right-hand)

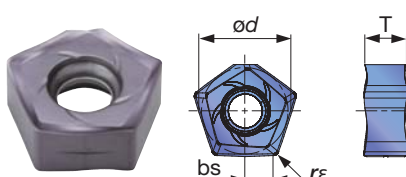

P	Steel	☆	★	★		☆	★					
M	Stainless		☆	☆	★							
K	Cast iron	★	☆	★	★							
N	Non-ferrous									★		
S	Superalloys	☆	★	☆								
H	Hard materials											

★ : First choice
☆ : Second choice

Designation	r_ϵ	Max. ap	Coated			Cermet	Un-coated	A	T	ϕd	bs
			AH120	AH140	AH725	AH3135	T1115				
PNCU0905GNER-MJ	0.031	0.252	●	●	●	●		0.350	0.232	0.480	0.055
PNCU0905GNEN-ML	0.031	0.252			●			0.350	0.232	0.480	0.055
PNCU0905GNFR-AJ	0.031	0.252					●	0.350	0.248	0.480	0.055
PNMU0905GNEN-MJ	0.031	0.252	●		●	●		0.350	0.236	0.480	0.055
PNCU0905GNER-W	0.031	0.079		●				-	0.236	0.480	0.150

● : Line up

STANDARD CUTTING CONDITIONS

ISO	Workpiece material	Hardness HB	Selection criteria	Recommended grade	Chip-breaker	Cutting speed Vc (sfm)	Feed per tooth fz (ipt)
P	Low carbon steels 1015 etc.	- 200	First choice	AH3135, AH725	MJ	330 - 820	0.004 - 0.024
		- 200	Low cutting force	AH3135	ML	330 - 820	0.004 - 0.020
		- 200	Priority on wear resistance	T3130	MJ	390 - 820	0.004 - 0.024
		- 200	Priority on surface quality	NS740	MJ	330 - 820	0.004 - 0.020
	High carbon steels 1045 etc.	200 - 300	First choice	AH3135, AH725	MJ	330 - 760	0.004 - 0.020
		200 - 300	Low cutting force	AH3135	ML	330 - 760	0.004 - 0.016
		200 - 300	Priority on wear resistance	T3130	MJ	390 - 820	0.004 - 0.020
		200 - 300	Priority on surface quality	NS740	MJ	330 - 820	0.004 - 0.016
	Alloyed steels 4140 etc.	150 - 300	First choice	AH3135, AH725	MJ	330 - 760	0.004 - 0.020
		150 - 300	Low cutting force	AH3135	ML	330 - 760	0.004 - 0.016
		150 - 300	Priority on wear resistance	T3130	MJ	390 - 820	0.004 - 0.020
		150 - 300	Priority on fracture resistance	NS740	MJ	330 - 820	0.004 - 0.016
Tool steels D2 etc.	- 300	First choice	AH3135, AH725	MJ	330 - 590	0.004 - 0.020	
	- 300	Low cutting force	AH3135	ML	330 - 590	0.004 - 0.016	
	- 300	Priority on wear resistance	T3130	MJ	390 - 590	0.004 - 0.020	
M	Stainless steels S30400 etc.	-	First choice	AH3135	ML	300 - 590	0.004 - 0.016
		-	Priority on fracture resistance	AH3135, AH140	MJ	300 - 590	0.004 - 0.018
K	Gray cast irons No.250B, No.300B etc.	-	First choice	AH120	MJ	460 - 820	0.004 - 0.024
		-	Priority on wear resistance	T1215	MJ	490 - 280	0.004 - 0.024
	Ductile cast irons 60-40-18 etc.	-	First choice	AH120	MJ	330 - 660	0.004 - 0.024
		-	Priority on wear resistance	T1215	MJ	390 - 720	0.004 - 0.024
N	Aluminum alloys Si < 13%	-	First choice	TH10	AJ	1640 - 4921	0.004 - 0.020
	Aluminum alloys Si ≥ 13%	-	First choice	TH10	AJ	490 - 1640	0.004 - 0.020
S	Titanium alloys Ti-6Al-4V, etc.	-	First choice	AH3135	ML	98 - 197	0.004 - 0.016
		-	Priority on fracture resistance	AH3135	MJ	98 - 197	0.004 - 0.016
	Heat-resistance alloys Inconel 718, etc.	-	First choice	AH725	MJ	66 - 164	0.002 - 0.004

Face Milling

- Remove excessive chip with an air blast to prevent chip jamming.
- Use water-soluble coolant to avoid built-up edge in case extreme welding occurs on cutting edges. (ex. aluminum machining).
- For the operation with depth of cut which varies (ex. casting skin) and machining of workpiece materials with interrupted surface, the feed (fz) should be set to the lower recommended value shown in the above table.
- Cutting conditions may be limited depending on machine power, workpiece rigidity, and spindle output. When the cutting width, depth or overhang length is large, set Vc and fz to the lower recommended values and check the machine power and vibration.

Installation of the extra close pitch cutter inserts

- The extra close pitch cutter has a slanted screw.
- Locate insert and then fasten the screw. (Fig. A)
- Appropriate torque is 3.5 N·m. (2.58 lbf·ft)
- After fastening the screw, please ensure there is no space between the cutter body and insert. (Fig. B)

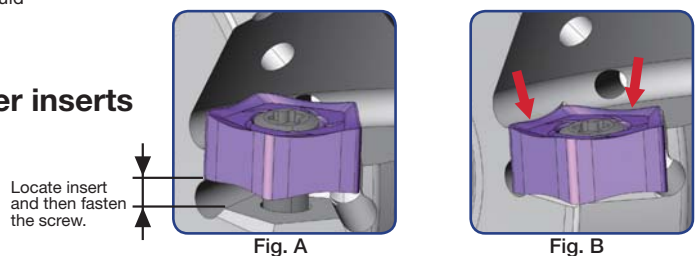

NOTES ON USE OF WIPER INSERT

- To achieve a good surface finish, a wiper insert is recommended. (PNCU0905GNER-W)
- When using the wiper insert, install the insert as shown in Fig. C. Ensure that the groove is at the front as shown in Fig. D.
- The wiper insert has two wiping corners. (Fig. D)
- Do not use the other corners. It may break the tool body.

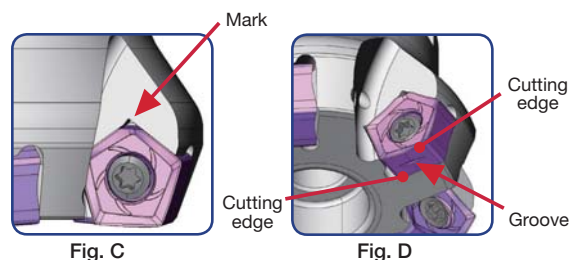

A.R.=+17°~+20°,R.R.=-16°~-11°

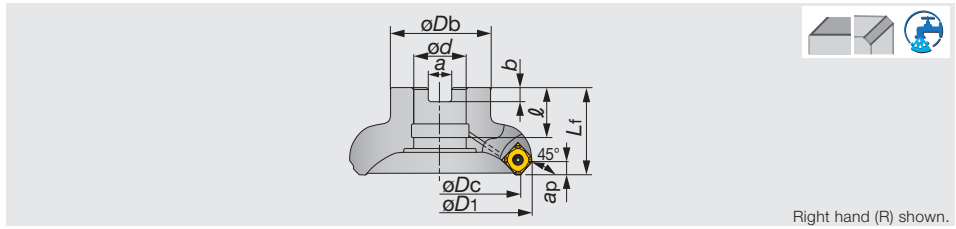

Right hand (R) shown.

Inch	ϕDc	z	$\phi D1$	ϕDb	L_f	ϕd	ℓ	a	b	lb	Air hole	Insert
TAW13R200U0075A03	2.000	3	2.510	1.693	1.575	0.750	0.750	0.315	0.197	0.88	With	SW*T13...
TAW13R200U0075A04	2.000	4	2.510	3.970	1.575	0.750	0.750	0.315	0.197	0.88	With	SW*T13...
TAW13R200U0075A05	2.000	5	2.510	3.970	1.575	0.750	0.750	0.315	0.197	0.88	With	SW*T13...
TAW13R300U0100A04	3.000	4	3.510	1.969	1.969	1.000	1.020	0.374	0.236	1.98	With	SW*T13...
TAW13R300U0100A06	3.000	6	3.510	3.970	1.969	1.000	1.020	0.374	0.236	1.98	With	SW*T13...
TAW13R300U0100A08	3.000	8	3.510	3.970	1.969	1.000	1.020	0.374	0.236	1.98	With	SW*T13...
TAW13R400U0150A05	4.000	5	4.520	3.150	1.969	1.500	1.378	0.626	0.394	3.75	With	SW*T13...
TAW13R400U0150A07	4.000	7	4.520	3.970	1.969	1.500	1.378	0.626	0.394	3.53	With	SW*T13...
TAW13R400U0150A10	4.000	10	4.520	3.970	1.969	1.500	1.378	0.626	0.394	3.75	With	SW*T13...
TAW13R500U0150A08	5.000	6	5.510	3.150	2.480	1.500	1.457	0.626	0.394	6.17	With	SW*T13...
TAW13R500U0150A06	5.000	8	5.510	3.970	2.480	1.500	1.457	0.626	0.394	5.95	With	SW*T13...
TAW13R500U0150A12	5.000	12	5.510	3.970	2.480	1.500	1.457	0.626	0.394	6.17	With	SW*T13...
TAW13R600U0200A07	6.000	7	6.510	3.970	2.480	2.000	1.500	0.748	0.433	9.04	Without	SW*T13...
TAW13R600U0200A10	6.000	10	6.510	3.970	2.480	2.000	1.500	0.748	0.433	8.60	Without	SW*T13...
TAW13R600U0200A16	6.000	16	6.510	3.970	2.480	2.000	1.500	0.748	0.433	9.04	Without	SW*T13...

Face Milling

SPARE PARTS								
Designation	③Clamping screw	Lubricant	①Shim screw	Center bolt (Optional parts)	Center bolt 1 (Optional parts)	②Shim	Wrench	Wrench 1
TAW13R200...	CSPB-3.5	M-1000	DTS5-3.5SS	-	(C0.375X1.125H)	FSSA1102	IP-15D	P-3.5
TAW13R300...	CSPB-3.5	M-1000	DTS5-3.5SS	-	(C0.500X1.375H)	FSSA1102	IP-15D	P-3.5
TAW13R400, 500...	CSPB-3.5	M-1000	DTS5-3.5SS	(TMBA-0.750H)	-	FSSA1102	IP-15D	P-3.5
TAW13R600...	CSPB-3.5	M-1000	DTS5-3.5SS	-	-	FSSA1102	IP-15D	P-3.5

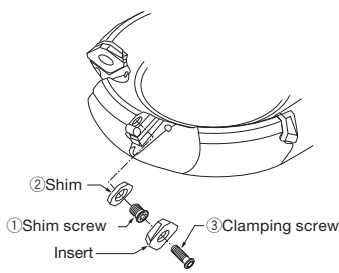

Reference pages

Inserts → **D111**, Standard cutting conditions → **D112 - D113**

EAW13

30°~ 45° endmills with screw clamped SWMT/SWGT13 inserts

A.R.=+17°~+20°,R.R.=−16°~−11°

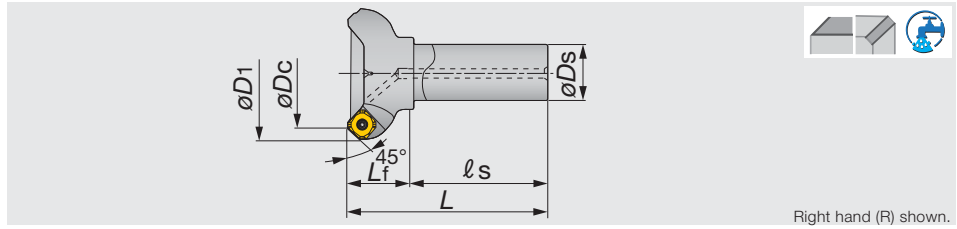

Right hand (R) shown.

Metric	ϕDc	z	$\phi D1$	ϕDs	ℓs	L_f	L	Kg	Air hole	Insert
EAW13R025M25.0-02	25	2	39	25	80	35	115	0.4	with	SW*T13/WWCW13...
EAW13R032M32.0-02	32	2	46	32	80	35	115	0.7	with	SW*T13/WWCW13...
EAW13R040M32.0-03	40	3	54	32	80	35	115	0.8	with	SW*T13/WWCW13...
EAW13R050M32.0-03	50	3	63	32	80	40	120	1	with	SW*T13/WWCW13...
EAW13R050M32.0-04	50	4	63	32	80	40	120	0.9	with	SW*T13/WWCW13...
EAW13R063M32.0-04	63	4	76	32	80	40	120	1.1	with	SW*T13/WWCW13...
EAW13R063M32.0-05	63	5	76	32	80	40	120	1.1	with	SW*T13/WWCW13...
EAW13R080M32.0-04	80	4	94	32	80	40	120	1.5	with	SW*T13/WWCW13...
EAW13R080M32.0-06	80	6	94	32	80	40	120	1.4	with	SW*T13/WWCW13...

SPARE PARTS

Designation	③ Clamping screw	Lubricant	① Shim screw	② Shim	Wrench	Wrench 1
EAW13R025**~040**	CSPB-3.5	M-1000	-	-	IP-15D	-
EAW13R050**~080**	CSPB-3.5	M-1000	DTS5-3.5SS	FSSA1102	IP-15D	P-3.5

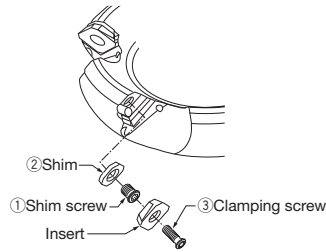

Face Milling

Reference pages

Inserts → **D111**, Standard cutting conditions → **D112 - D113**

INSERT

SWMT13T3-MJ

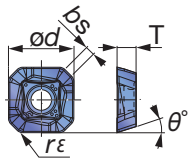

SWMT13T3-ML

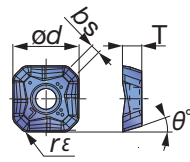

SWMW13T3 (Flat)

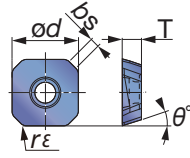

SWMT13T3-HJ

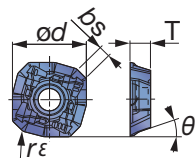

SWMT13T3-MS

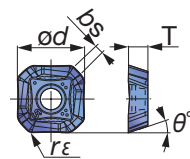

SWG13T3-MJ

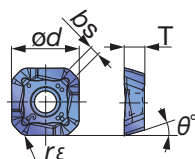

SWG13T3-AJ

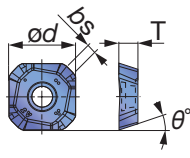

WWCW13T3AFER-WS

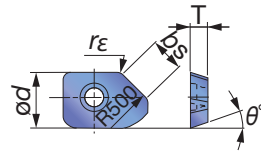

WWCW13T3AFE/FR-WS

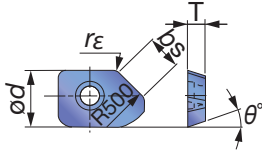

WWCW13T3AFFR-WD

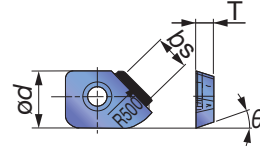

Face Milling

P	Steel	☆		★						★								
M	Stainless		★	☆	★													
K	Cast iron	★				★	★	★										
N	Non-ferrous									★			★		★			
S	Superalloys	★	☆	☆														
H	Hard materials																	

★ : First choice
☆ : Second choice

Designation	r_ϵ	Max. ap	Coated								Cermet	Un-coated	PCD	ϕd	T	θ°	bs	
			AH120	AH130	AH140	AH3135	GH110	T1115	T1215	T3130								DS1100
SWMT13T3AFPR-MJ	0.059	0.157	●	●	●	●			●	●	●				0.547	0.157	18.5	0.079
SWMT13T3AFER-ML	0.059	0.098	●	●											0.547	0.157	18.5	0.079
SWMW13T3AFTR	0.059	0.197	●					●	●	●					0.547	0.157	18.5	0.079
SWMT13T3AFPR-HJ	0.059	0.079	●	●	●			●	●	●					0.579	0.157	18.5	0.091
SWMT13T3AFPR-MS	0.039	0.157		●	●	●									0.555	0.157	18.5	0.079
SWG13T3AFPR-MJ	0.059	0.157	●								●				0.547	0.157	18.5	0.079
SWG13T3AFFR-AJ	-	0.157								●		●			0.555	0.157	18.5	0.079
WWCW13T3AFER-WS	0.059	-						●			●				0.504	0.157	18.5	0.307
WWCW13T3AFFR-WS	0.059	-									●				0.504	0.157	18.5	0.307
WWCW13T3AFFR-WD	-	-											●		0.504	0.157	18.5	0.307

● : Line up
DX140 : Packing Quantity = 1 pc.

STANDARD CUTTING CONDITIONS

ISO	Workpiece material	Priority	Grade	Cutting speed v_c (sfm)	Roughing (Depth of cut: > 0.394")					
					Feed per tooth: f_z (ipt)					
					MJ	ML	HJ	MS	Flat	AJ
P	Mild and low carbon steels 1010, 1015, etc. < 180 HB	First choice	AH3135 AH120	330 - 890	0.002 - 0.012	0.002 - 0.010	0.008 - 0.024	0.004 - 0.010	0.002 - 0.012	-
		Priority on wear resistance	T3130	490 - 300	0.002 - 0.012	-	0.008 - 0.024	-	0.002 - 0.012	-
		Priority on surface quality	NS740	330 - 980	0.002 - 0.009	-	-	-	0.002 - 0.009	-
	Carbon and alloy steels 1045, 4140, etc. < 300 HB	First choice	AH3135 AH120	330 - 760	0.002 - 0.010	0.002 - 0.008	0.008 - 0.020	-	0.002 - 0.010	-
		Priority on wear resistance	T3130	490 - 910	0.002 - 0.010	-	0.008 - 0.020	-	0.002 - 0.010	-
		Priority on surface quality	NS740	330 - 760	0.002 - 0.008	-	-	-	0.002 - 0.008	-
	Die steels H13, D2, etc. < 30 HRC	First choice	AH3135 AH120	330 - 590	0.002 - 0.008	0.002 - 0.008	0.008 - 0.016	-	0.002 - 0.008	-
		Priority on wear resistance	T3130	330 - 590	0.002 - 0.008	-	0.008 - 0.016	-	0.002 - 0.008	-
M	Stainless steels S30400, S31600, etc. < 250 HB	First choice	AH3135 AH130	260 - 660	0.004 - 0.010	-	0.008 - 0.020	0.004 - 0.008	-	-
		Priority on wear resistance	AH120	490 - 820	0.004 - 0.010	0.004 - 0.008	0.008 - 0.020	-	0.004 - 0.010	-
K	Gray cast irons No.250B, No.300B, etc.	First choice	T1215	590 - 980	0.002 - 0.010	-	0.008 - 0.024	-	0.002 - 0.010	-
		Priority on impact resistance	AH120	490 - 820	0.002 - 0.010	0.002 - 0.008	0.008 - 0.024	-	0.002 - 0.010	-
	Ductile cast irons 60-40-18, 80-55-06, etc.	First choice	T1215	390 - 660	0.002 - 0.010	-	0.008 - 0.024	-	0.002 - 0.010	-
		Priority on impact resistance	AH120	330 - 590	0.002 - 0.010	0.002 - 0.008	0.008 - 0.024	-	0.002 - 0.010	-
N	Aluminum alloys Si < 13 %	-	DS1100 KS05F	300 - 3281	-	-	-	-	-	0.002 - 0.008
	Aluminum alloys Si ≥ 13 %	-	DS1100 KS05F	260 - 980	-	-	-	-	-	0.002 - 0.008
	Copper alloys	-	DS1100 KS05F	660 - 1640	-	-	-	-	-	0.002 - 0.008

Face Milling

Notes for use of HJ-type inserts

HJ-type inserts can be used for high feed machining.

When using the insert, care should be taken with the following:

- The maximum depth of cut is $a_p = 0.079"$. Select feeds within the above value.
- Do not use the HJ-type inserts with other types (such as MJ- and MS-types) in the same body.
- The outer shape of the HJ-type insert is different from those of other types (such as MJ- and MS-types), but the insert can be held in the same insert pocket.

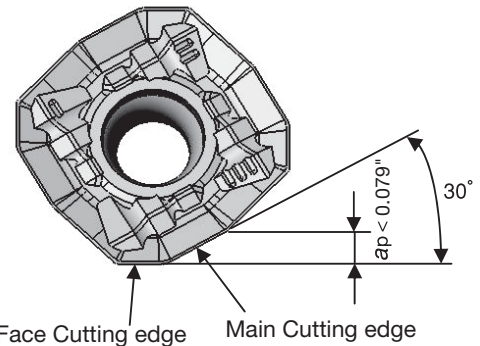

Notes on use of wiper insert

- When requiring good surface finishes, use of a wiper insert (WWCW13T3AF_ R-W_) is recommended. In general, installing one wiper insert delivers superior surface finishes.
- When using the wiper insert, install the insert as shown in Fig. A. If the insert is installed as shown in Fig. B, breakage of the insert is inevitable and normal surface finish can not be obtained.
- The wiper insert must not be used together with HJ-type inserts
- The wiper insert has one wiping corner.
- The peripheral cutting edge of the wiper insert is retracted from the edge of the normal inserts. Therefore, the feed per tooth (ipt) of the normal insert following the wiper insert is double that of other inserts.
- When using the wiper insert, depth of cut (a_p) less than 0.039" is recommended.

Fig. A

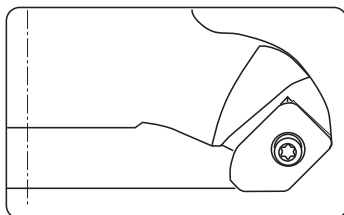
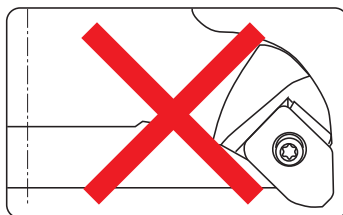

Fig. B



ISO	Workpiece material	Priority	Grade	Cutting speed vc (sfm)	Light cutting to finishing (Depth of cut: ≤ 0.394")					
					Feed per tooth: fz (ipt)					
					MJ	ML	HJ	MS	Flat	AJ
P	Mild and low carbon steels 1010, 1015, etc. < 180 HB	First choice	AH3135 AH120	330 - 890	0.002 - 0.010	0.002 - 0.008	0.008 - 0.024	0.004 - 0.008	0.002 - 0.010	-
		Priority on wear resistance	T3130	490 - 980	0.002 - 0.010	-	0.008 - 0.024	-	0.002 - 0.010	-
		Priority on surface quality	NS740	330 - 980	0.002 - 0.008	-	-	-	0.002 - 0.008	-
	Carbon and alloy steels 1045, 4140, etc. < 300 HB	First choice	AH3135 AH120	330 - 760	0.002 - 0.008	0.002 - 0.006	0.008 - 0.020	-	0.002 - 0.008	-
		Priority on wear resistance	T3130	490 - 920	0.002 - 0.008	-	0.008 - 0.020	-	0.002 - 0.008	-
		Priority on surface quality	NS740	330 - 760	0.002 - 0.007	-	-	-	0.002 - 0.007	-
	Die steels H13, D2, etc. < 30 HRC	First choice	AH3135 AH120	330 - 1590	0.002 - 0.007	0.002 - 0.005	0.008 - 0.016	-	0.002 - 0.007	-
		Priority on wear resistance	T3130	330 - 590	0.002 - 0.007	-	0.008 - 0.016	-	0.002 - 0.007	-
M	Stainless steels S30400, S31600, etc. < 250 HB	First choice	AH3135 AH130	260 - 660	0.004 - 0.008	-	0.008 - 0.020	0.004 - 0.007	-	-
		Priority on wear resistance	AH120	590 - 820	0.004 - 0.008	0.004 - 0.007	0.008 - 0.020	-	0.004 - 0.008	-
K	Gray cast irons No.250B, No.300B, etc.	First choice	T1215	590 - 980	0.004 - 0.008	-	0.008 - 0.024	-	0.004 - 0.008	-
		Priority on impact resistance	AH120	490 - 820	0.004 - 0.008	0.002 - 0.007	0.008 - 0.024	-	0.004 - 0.008	-
	Ductile cast irons 60-40-18, 80-55-06, etc.	First choice	T1215	390 - 660	0.004 - 0.008	-	0.008 - 0.024	-	0.004 - 0.008	-
		Priority on impact resistance	AH120	330 - 590	0.004 - 0.008	0.002 - 0.007	0.008 - 0.024	-	0.004 - 0.008	-
N	Aluminum alloys Si < 13 %	-	DS1100 KS05F	990 - 3281	-	-	-	-	-	0.002 - 0.008
	Aluminum alloys Si ≥ 13%	-	DS1100 KS05F	260 - 980	-	-	-	-	-	0.002 - 0.008
	Copper alloys	-	DS1100 KS05F	660 - 1640	-	-	-	-	-	0.002 - 0.008

Notes:

- When cutting at a large depth of cut or a large cutting width, the cutting speed (vc) and feed (fz) should be set to the lower side of the values shown in the above table.
- Dry cutting (or air-blowing) is generally recommended. However, when chips tend to excessively adhere to the cutting edges when machining

stainless steel, use a water soluble cutting fluid. In this case, use the AH130 grade at speeds lower than vc = 330 sfm.

- When wet machining mild steels, carbon steels and alloy steels, use T3130 at lower cutting conditions.
- TAW13 type TAC mills cannot be used for axial-feed cutting such as ramping, plunging and drilling.



Face Milling

TFE12RU

86° face mills with screw clamped inserts for aluminum machining

A.R. = +13°, R.R. = +7°

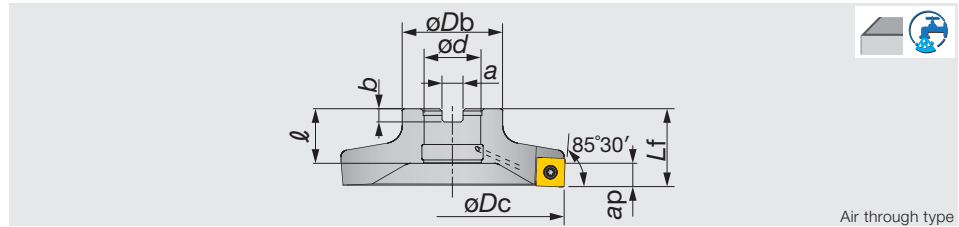

Air through type

Inch	Max. ap	ϕDc	z	ϕDb	L_f	ϕd	ℓ	a	b	lb	Air hole	Insert
TFE12300RU	0.315	3.000	4	1.970	1.380	1.000	0.964	0.375	0.236	0.88	with	SEG*12X4...
TFE12400RU	0.315	4.000	6	1.970	1.380	1.000	0.964	0.375	0.236	1.34	with	SEG*12X4...
Metric	Max. ap	ϕDc	z	ϕDb	L_f	ϕd	ℓ	a	b	Kg	Air hole	Insert
TFE12063R	8	63	3	45	35	22	19	10	6	0.34	with	SEG*12X4...
TFE12125R	8	125	6	50	35	25.4	24.5	9.5	6	0.9	with	SEG*12X4...

SPARE PARTS

Designation	① Clamping screw	Lubricant	Center bolt	Center bolt 1	Wrench
TFE12300RU	CSPB-4S	M-1000	TMBA-0.500H	-	IP-15D
TFE12400RU	CSPB-4S	M-1000	TMBA-0.500H	-	IP-15D
TFE12063R	CSPB-4S	M-1000	-	CM10X30H	IP-15D
TFE12125R	CSPB-4S	M-1000	TMBA-0.500H	-	IP-15D

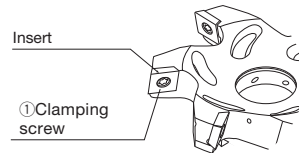

EFE12RU

86° endmills with screw clamped inserts for aluminum machining

A.R. = +13°, R.R. = +7°

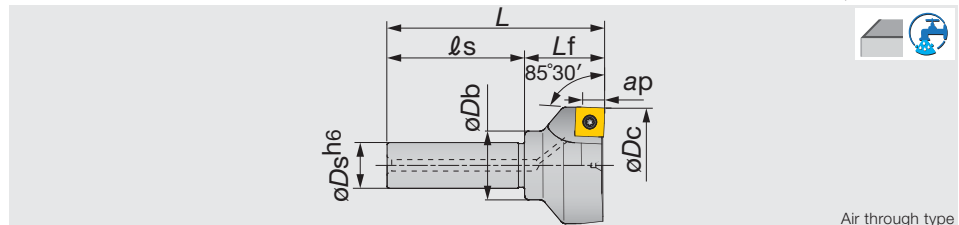

Air through type

Inch	Max. ap	ϕDc	z	ϕDs	ϕDb	ℓ_s	L_f	L	lb	Air hole	Insert
EFE12200RU	0.315	2.000	3	0.750	1.180	2.362	1.375	3.406	0.77	with	SEG*12X4...

SPARE PARTS

Designation	① Clamping screw	Lubricant	Wrench
EFE12200RU	CSPB-4S	M-1000	IP-15D

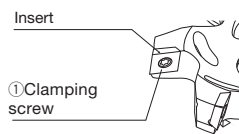

Reference pages

Inserts → D115, Standard cutting conditions → D116

INSERT

SEGW12X4ZEFR / ZEFR

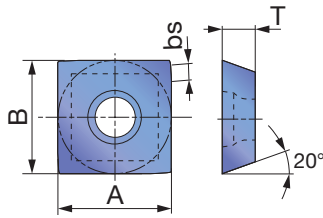

SEGT12X4-AJ

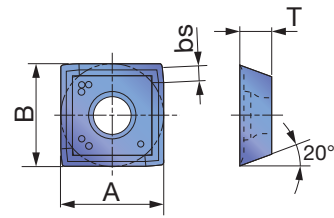

SEGW12X4ZEFR-D

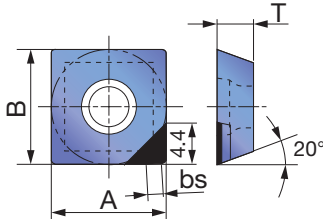

SEGW12X4ZEFR-WD

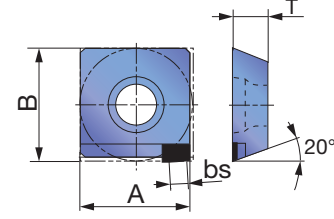

SEGW12X4ZEFR-BD

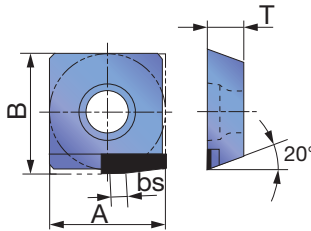

Face Milling

P Steel	★			★					
M Stainless		★							
K Cast iron	★								
N Non-ferrous			★		★	★			
S Superalloys	★								
H Hard materials									

★ : First choice
☆ : Second choice

Designation	Max. ap	Coated		Cermet	Un-coated	PCD					
		AH120	AH140	DS1100	NS740	KS05F	DX140	A	B	T	bs
SEGW12X4ZEFR	0.315					●		0.500	0.500	0.157	0.071
SEGW12X4ZEPR	0.315	●	●		●			0.500	0.500	0.157	0.055
SEGT12X4ZEFR-AJ	0.315			●				0.500	0.500	0.157	0.071
SEGW12X4ZEFR-D	0.138					●		0.500	0.500	0.157	0.071
SEGW12X4ZEFR-WD	-					●		0.488	0.504	0.157	0.079
SEGW12X4ZEFR-BD	-					●		0.488	0.516	0.157	0.071

● : Line up
DX140 : Package quantity = 1pc.

STANDARD CUTTING CONDITIONS

ISO	Workpiece material	Grade	Designation	Cutting speed Vc (sfm)	Feed per tooth fz (ipt)
P	Carbon steels and alloy steels ($< 300\text{HB}$)	AH120	SEGW12X4ZEPR	330 ~ 590	0.001 ~ 0.006
		NS740	SEGW12X4ZEPR	330 ~ 590	0.001 ~ 0.006
M	Stainless steels ($< 250\text{HB}$)	AH140	SEGW12X4ZEPR	260 ~ 590	0.001 ~ 0.006
K	Grey and ductile cast irons	AH120	SEGW12X4ZEPR	330 ~ 650	0.001 ~ 0.006
	Cast aluminum alloy / Die-cast (Si $< 13\%$)	KS05F	SEGT12X4ZEFR-AJ	650 ~ 4900	0.001 ~ 0.008
		DX140	SEGW12X4ZEFR-D	650 ~ 4900	0.001 ~ 0.008
	Cast aluminum alloy / Die-cast (Si $\geq 13\%$)	KS05F	SEGT12X4ZEFR-AJ	260 ~ 650	0.001 ~ 0.008
		DX140	SEGW12X4ZEFR-D	650 ~ 1650	0.001 ~ 0.008
N	Aluminum alloy (JIS 1000, 3000, 5000 and 6000 types) Tensile strength $< 350\text{ N/mm}^2$	KS05F	SEGT12X4ZEFR-AJ	650 ~ 4900	0.001 ~ 0.008
		DX140	SEGW12X4ZEFR-D	650 ~ 4900	0.001 ~ 0.008
	Aluminum alloy (JIS 2000, 4000, and 7000 types) Tensile strength $> 350\text{ N/mm}^2$	KS05F	SEGW12X4ZEFR	650 ~ 4900	0.001 ~ 0.008
		DX140	SEGW12X4ZEFR-D	650 ~ 4900	0.001 ~ 0.008
	Copper alloy	KS05F	SEGT12X4ZEFR-AJ	650 ~ 1640	0.001 ~ 0.008
		DX140	SEGW12X4ZEFR-D	650 ~ 1640	0.001 ~ 0.008

Notes:

- In milling aluminum and copper alloys:
 - For improved surface finish, use together with wiper insert
SEGW12X4ZEFR-WD
 - For reducing burr occurrence, use together with deburring inserts
SEGW12X4ZEFR-BD
- When milling aluminum and copper alloys, use of a water soluble cutting fluid is recommended. When milling steels, cast irons, and stainless steels, dry cutting is recommended.
- When the length-to-diameter overhang ratio of the tool (L/D) exceeds 3, reduce cutting speed and feed to 70 to 80% of the values given in the table.



Face Milling

DPD09

Light weight square mills with PCD inserts for aluminum machining

A.R. = +8.5°, R.R. = +3° ~ +5°

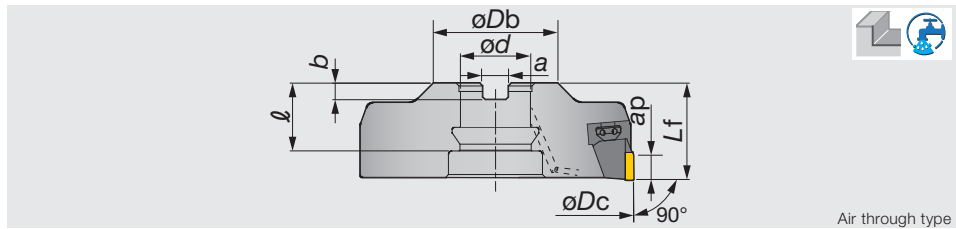

Air through type

Metric	Max. ap	ϕD_c	z	ϕD_b	L_f	ϕd	ℓ	a	b	Kg	Air hole	Insert
DPD09080R	7	80	4	50	41	25.4	23	9.5	6	0.8	with	YDEN0905...
DPD09080RB	7	80	6	50	41	25.4	28.5	9.5	6	0.82	with	YDEN0905...
DPD09100R	7	100	6	50	35	25.4	24.5	9.5	6	1.13	with	YDEN0905...
DPD09100RB	7	100	8	50	35	25.4	24.5	9.5	6	1.17	with	YDEN0905...
DPD09125R	7	125	6	50	35	25.4	24.5	9.5	6	1.7	with	YDEN0905...
DPD09125RB	7	125	10	50	35	25.4	24.5	9.5	6	1.77	with	YDEN0905...
DPD09160R	7	160	8	60	52	31.75	40	12.7	8	3.28	with	YDEN0905...
DPD09160RB	7	160	12	60	52	31.75	40	12.7	8	3.25	with	YDEN0905...

SPARE PARTS



Designation	① Wedge	② Wedge fixing screw	③ Adjusting screw	④ Helisert	Center bolt	Center bolt 1	Wrench	Wrench 1
DPD09080R*	FW-304R-T	FDS-8ST-18	AJM5	LM5-0.8X1DNS	-	CM12X30H	T-27T	T-7F
DPD09100R*	FW-304R-T	FDS-8ST-18	AJM5	LM5-0.8X1DNS	TMBA-0.500H	-	T-27T	T-7F
DPD09125R*	FW-304R-T	FDS-8ST-18	AJM5	LM5-0.8X1DNS	TMBA-0.500H	-	T-27T	T-7F
DPD09160R*	FW-304R-T	FDS-8ST-18	AJM5	LM5-0.8X1DNS	TMBA-0.500H	-	T-27T	T-7F

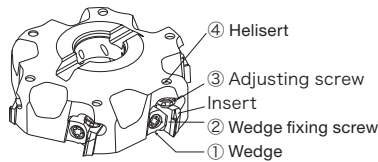

EDPD09

Light weight square endmills with PCD inserts for aluminum machining

A.R. = +8.5°, R.R. = +3°

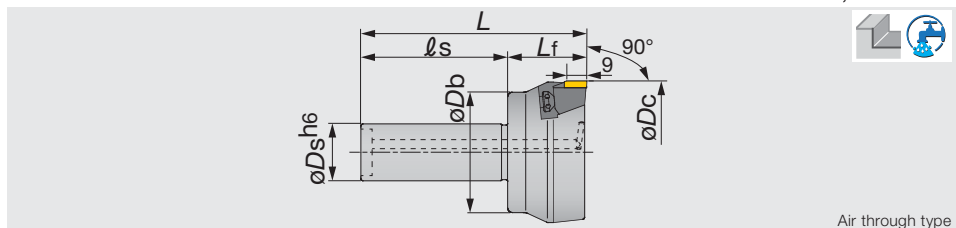

Air through type

Metric	Max. ap	ϕD_c	z	ϕD_s	ϕD_b	ℓ_s	L_f	L	Kg	Air hole	Insert
EDPD09063R	7	63	3	25	37	60	40	100	0.75	with	YDEN0905...

SPARE PARTS



Designation	① Wedge	② Wedge fixing screw	③ Adjusting screw	④ Helisert	Wrench	Wrench 1
EDPD09063R	FW-304R-T	FDS-8SST	AJM5	LM5-0.8X1DNS	T-27T	T-7F

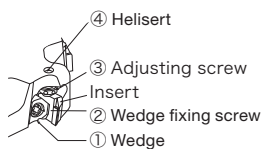

Reference pages

Inserts → D118, Standard cutting conditions → D119

Face Milling

INSERT

YDEN0905PDFR-D

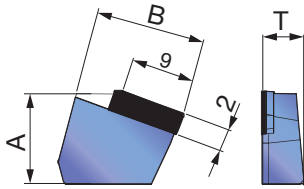

YDEN0905PDFR-WD

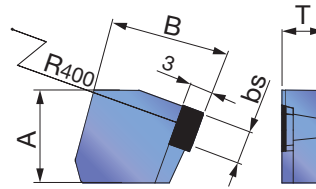

YDEN0905PDFR-BD

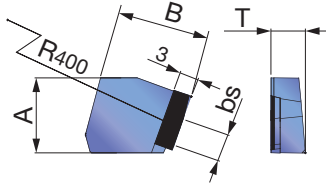

Face Milling

P	Steel								
M	Stainless								
K	Cast iron								
N	Non-ferrous	★							
S	Superalloys								
H	Hard materials								

★ : First choice
☆ : Second choice

Designation	Max. ap	PCD							A	B	T	bs
		DX140										
YDEN0905PDFR-D	0.276	●							0.488	0.594	0.224	-
YDEN0905PDFR-WD	-	●							0.488	0.598	0.224	0.177
YDEN0905PDFR-BD	-	●							0.488	0.598	0.224	0.177

Note: As a principle, our company re-grinds these inserts.

● : Line up

Package quantity = 1pc.

STANDARD CUTTING CONDITIONS

ISO	Workpiece material	Grade	Designation	Cutting speed Vc (sfm)	Feed per tooth fz (ipt)
N	Aluminum alloy castings & die castings Si < 13%	DX140	YDEN0905PDFR-D	500 ~ 4000	0.001 ~ 0.008
	Aluminum alloy castings & die castings Si ≥ 13%	DX140	YDEN0905PDFR-D	650 ~ 1650	0.001 ~ 0.008
	Rolled aluminum alloys	DX140	YDEN0905PDFR-D	1650 ~ 13000	0.001 ~ 0.008
	Copper alloys	DX140	YDEN0905PDFR-D	300 ~ 1650	0.001 ~ 0.008

Notes:

- When requiring improved surface finish, use the wiper insert together with regular inserts YDEN0905PDFR-WD.
- When requiring reduced burr occurrence, use the deburring inserts together with regular inserts YDEN0905PDFR-BD.
- When using the cutter at speeds over 4920 SFM, use an arbor or tool-holder balanced to within G16.
- Wet cutting, using a water soluble cutting fluid, is recommended.
- When the length-to-diameter overhang ratio of the tool (L/D) exceeds 3, reduce cutting speed and feed to 70 to 80% of the values given in the table.

HOW TO PUT EACH INSERT TOGETHER

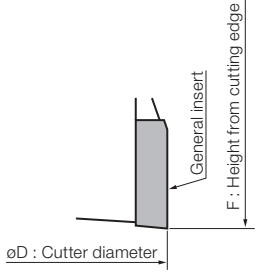
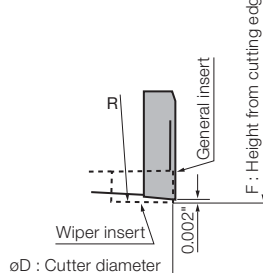
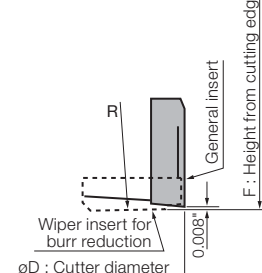
		For general	Accuracy of machining surface priority	Burr reduction priority
Applicable insert	General insert YDEN0905PDFR-D	◎	◎	◎
	Wiper insert YDEN0905PDFR-WD	-	◎	-
	Wiper insert for burr reduction YDEN0905PDFR-BD	-	-	◎
Number of Inserts by type		All general	1 or 2 wiper inserts in cutter body	General insert : Burr wiper insert = 1 : 1
Specification of insert setting				
Accuracy of machining surface (roughness and undulation)		△	◎	○
Burr of machining surface		△	○	◎



Face Milling

TMD4400RI-U

45° face mills with wedge clamped square inserts

A.R. = +15°, R.R. = -3°

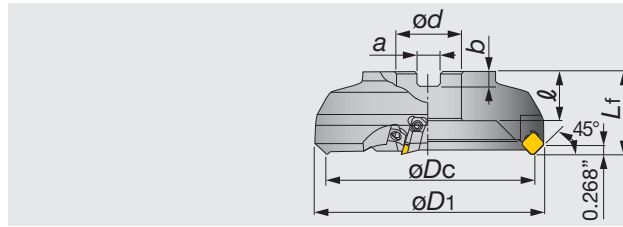

Right hand (R) shown.

Inch	Max. ap	ϕD_c	z	ϕD_1	L_f	ϕd	ℓ	a	b	lb	Insert
TMD4403RI-U	0.157	3.150	4	3.780	1.970	1.000	1.020	0.375	0.236	3.100	SD*N42.../SD*R1203.../ WDCN42ZFR-DIA
TMD4404RI-U	0.157	3.940	5	4.530	2.480	1.500	1.260	0.500	0.315	5.500	SD*N42.../SD*R1203.../ WDCN42ZFR-DIA
TMD4405RI-U	0.157	4.920	6	5.470	2.480	1.500	1.500	0.625	0.394	7.900	SD*N42.../SD*R1203.../ WDCN42ZFR-DIA
TMD4406RI-U	0.157	6.300	8	6.510	2.480	2.000	1.500	0.750	0.433	12.300	SD*N42.../SD*R1203.../ WDCN42ZFR-DIA
TMD4408RI-U	0.157	7.870	10	8.390	2.480	2.500	1.500	1.000	0.551	19.100	SD*N42.../SD*R1203.../ WDCN42ZFR-DIA
TMD4410RI-U	0.157	9.840	12	10.350	2.480	2.500	1.500	1.000	0.551	35.900	SD*N42.../SD*R1203.../ WDCN42ZFR-DIA
TMD4412RI-U	0.157	12.400	14	12.870	2.480	2.500	1.500	1.000	0.551	55.400	SD*N42.../SD*R1203.../ WDCN42ZFR-DIA

Face Milling

Arbor type

TMD4408/10RI-U

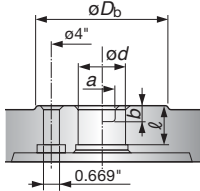

TMD4412RI-U

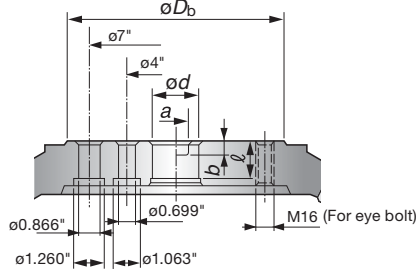

SPARE PARTS

Designation	① Locator	④ Wedge fixing screw	② Locator fixing screw	③ Wedge	Wrench
TMD44**RI-U	LD440R	FDS-8S	CM4X0.7X14	WP440R	TP-4

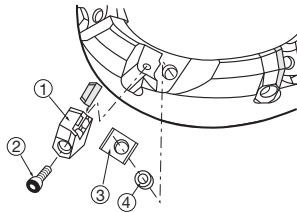

Reference pages

Inserts → **D122**, Standard cutting conditions → **D123**

TMD4400RB-U

45° face mills with wedge clamped square inserts

A.R. = +15°, R.R. = -3°

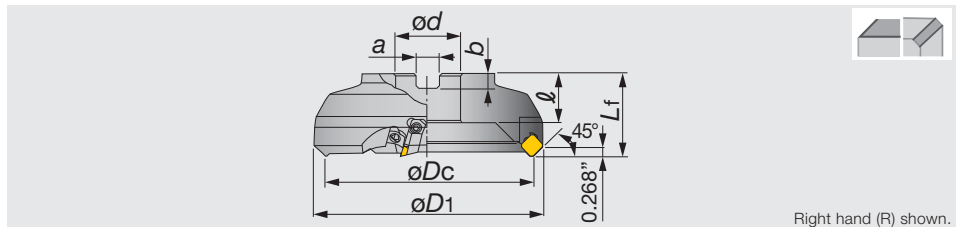

Right hand (R) shown.

Inch	Max. ap	ϕD_c	z	ϕD_1	L_f	ϕd	ℓ	a	b	lb	Insert
TMD4403RB-U	0.157	3.150	6	3.780	1.969	1.000	1.024	0.375	0.236	3.100	SD*N42.../SD*R1203.../ WDCN42ZFR-DIA
TMD4404RB-U	0.157	3.937	8	4.528	2.480	1.500	1.260	0.625	0.394	5.500	SD*N42.../SD*R1203.../ WDCN42ZFR-DIA
TMD4405RB-U	0.157	4.921	10	5.472	2.480	1.500	1.260	0.625	0.394	7.900	SD*N42.../SD*R1203.../ WDCN42ZFR-DIA
TMD4406RB-U	0.157	6.299	14	6.811	2.480	2.000	1.496	0.750	0.433	12.100	SD*N42.../SD*R1203.../ WDCN42ZFR-DIA
TMD4408RB-U	0.157	7.874	18	8.370	2.480	2.500	1.496	1.000	0.551	18.900	SD*N42.../SD*R1203.../ WDCN42ZFR-DIA
TMD4410RB-U	0.157	9.842	22	10.335	2.480	2.500	1.496	1.000	0.551	35.600	SD*N42.../SD*R1203.../ WDCN42ZFR-DIA

Arbor type

TMD04408/10RB-U

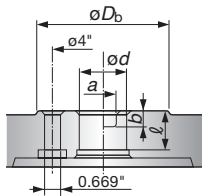

SPARE PARTS

Designation	① Locator	④ Wedge fixing screw	② Locator fixing screw	③ Wedge	Wrench
TMD44**RB-U	LD440R	FDS-8S	CM4X0.7X14	WF310R	TP-4

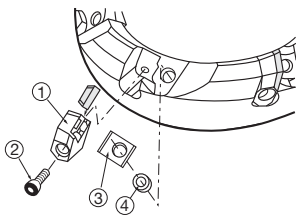

Reference pages

Inserts → **D122**, Standard cutting conditions → **D123**

INSERT

SDCN/SDEN/SDKN 42Z

General inserts
SD*N42Z*N

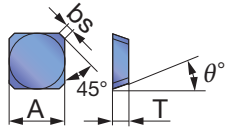

Corner details
SDKN42ZTN16



SD*N42ZTN20



SDKN42ZTNCR
SDEN42ZTNCR



SDCN42ZFN-DIA

SDCN42ZFN-DIA

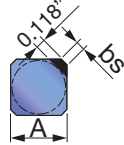

SDKR42Z-MJ

SDKR42ZSR-MJ
(With 3-dimensional chipbreaker)

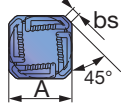

Corner details

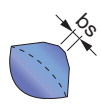

SDMR/SDKR 1203-MJ

SD*R1203AETN-MJ
(With 3-dimensional chipbreaker)

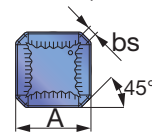

Corner details

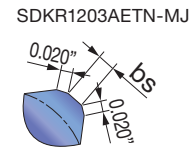
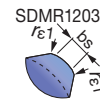

SDKR42Z-MS

SDKR42ZPN-MS

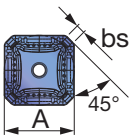

Corner details

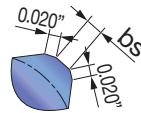

WDCN42ZFR-DIA

Wiper inserts
WDCN42ZFR-DIA

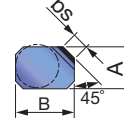

P Steel	★			★	☆		★		★	☆	☆						
M Stainless		★	☆														
K Cast iron	★						★				☆						
N Non-ferrous													★		★		
S Superalloys	★	☆															
H Hard materials																	

★ : First choice
☆ : Second choice

Designation	Max. ap	Coated							Cermet			Uncoated		PCD	A	B	T	θ°	bs
		AH120	AH130	AH140	AH330	GH330	T1115	T3130	NS740	N308	FX105	UX30	TH10	DX140					
SDCN42ZFN	0.157											●			0.500	-	0.125	15	0.047
SDCN42ZTN	0.157								●	●	●	●			0.500	-	0.125	15	0.047
SDCN42ZTN20	0.157								●						0.500	-	0.125	15	0.079
SDEN42ZFN	0.157											●			0.500	-	0.125	15	0.047
SDEN42ZTN	0.157	●		●		●	●		●	●		●			0.500	-	0.125	15	0.047
SDEN42ZTNCR	0.157	●		●	●				●						0.500	-	0.125	15	0.063
SDEN42ZTN20	0.157						●								0.500	-	0.125	15	0.079
SDKN42ZFN	0.157											●			0.500	-	0.125	15	0.047
SDKN42ZTN	0.157	●	●	●	●	●	●		●	●		●			0.500	-	0.125	15	0.047
SDKN42ZTNCR	0.157								●						0.500	-	0.125	15	0.063
SDKN42ZTN16	0.157						●								0.500	-	0.125	15	0.063
SDCN42ZFN-DIA	0.079												●		0.500	-	0.125	15	0.047
SDKR42ZSR-MJ	0.157	●			●	●	●								0.500	-	0.125	15	0.063
SDMR1203AETN-MJ	0.157								●						0.500	-	0.125	15	0.063
SDKR1203AETN-MJ	0.157								●						0.500	-	0.125	15	0.063
SDKR42ZPN-MS	0.157		●	●											0.500	-	0.125	15	0.063
WDCN42ZFR-DIA	0.020												●		0.480	0.616	0.125	15	0.193

● : Line up

DX140 : Package quantity = 1pc.

STANDARD CUTTING CONDITIONS

ISO	Workpiece material	Grade	Roughing (Depth of cut: ap 0.059" ~ 0.157")		Finishing (Depth of cut: ap 0.012" ~ 0.028")	
			Cutting speed vc (sfm)	Feed per tooth fz (ipt)	Cutting speed vc (sfm)	Feed per tooth fz (ipt)
P	Mild steels Unhardened steels < 180 HB	NS740	492 ~ 820	0.004 ~ 0.008	492 ~ 820	0.004 ~ 0.010
		AH330	492 ~ 1312	0.004 ~ 0.010	492 ~ 1312	0.004 ~ 0.011
		AH120	492 ~ 820	0.004 ~ 0.010	492 ~ 820	0.004 ~ 0.011
		T3130	492 ~ 984	0.004 ~ 0.011	591 ~ 984	0.004 ~ 0.012
		AH130 · AH140	328 ~ 591	0.004 ~ 0.011	427 ~ 656	0.004 ~ 0.012
	Carbon steels Alloy steels < 300 HB	T3130	492 ~ 919	0.004 ~ 0.010	591 ~ 919	0.004 ~ 0.011
		NS740 · N308	328 ~ 591	0.004 ~ 0.007	492 ~ 656	0.004 ~ 0.009
		AH330	328 ~ 1050	0.004 ~ 0.009	492 ~ 1050	0.004 ~ 0.010
		AH120	328 ~ 656	0.004 ~ 0.009	492 ~ 656	0.004 ~ 0.010
		UX30	262 ~ 427	0.004 ~ 0.010	328 ~ 492	0.004 ~ 0.011
Die steels < 30 HRC	AH120 · T3130	328 ~ 492	0.004 ~ 0.006	328 ~ 492	0.004 ~ 0.008	
	AH330	328 ~ 820	0.004 ~ 0.006	328 ~ 820	0.004 ~ 0.008	
M	Stainless steels < 250 HB	AH130 · AH140	262 ~ 591	0.006 ~ 0.010	328 ~ 656	0.006 ~ 0.011
		AH120 · GH330	492 ~ 755	0.006 ~ 0.009	656 ~ 820	0.006 ~ 0.010
K	Cast irons Ductile cast irons	T1115	328 ~ 656	0.004 ~ 0.008	328 ~ 656	0.004 ~ 0.010
		AH120	328 ~ 656	0.004 ~ 0.008	328 ~ 656	0.004 ~ 0.010
N	Aluminum alloys Si < 13%	TH10	656 ~ 3281	0.002 ~ 0.008	1148 ~ 3281	0.004 ~ 0.012
		DX140	656 ~ 3281	0.002 ~ 0.007	1148 ~ 3281	0.004 ~ 0.008
	Copper alloy	TH10	656 ~ 1640	0.004 ~ 0.008	656 ~ 1640	0.004 ~ 0.010

Face Milling

- Note:
- Dry cutting is recommended for all materials except for aluminum alloys.
 - Maximum depth of cut for DX140 SDCN42ZFN-DIA is 0.080".
 - When wet machining mild steels, carbon steels and alloy steels, use T3130 at lower cutting conditions.

TMD5400I-U

45° face mills with wedge clamped square inserts

A.R. = +15°, R.R. = -3°

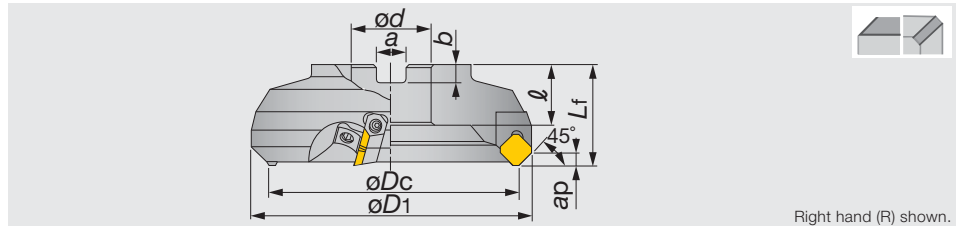

Right hand (R) shown.

Inch	Max. ap	ϕD_c	z	ϕD_1	L_f	ϕd	ℓ	a	b	lb	Insert
TMD5404RI-U	0.236	3.940	4	4.650	2.480	1.500	1.260	0.625	0.394	5.510	SD*N53Z...
TMD5405RI-U	0.236	4.920	5	5.590	2.480	1.500	1.500	0.625	0.394	8.160	SD*N53Z...
TMD5406RI-U	0.236	6.300	5	6.930	2.480	2.000	1.500	0.750	0.433	12.790	SD*N53Z...
TMD5408RI-U	0.236	7.870	8	8.500	2.480	2.500	1.500	1.000	0.551	19.840	SD*N53Z...
TMD5410RI-U	0.236	9.840	10	10.430	2.480	2.500	1.500	1.000	0.551	35.930	SD*N53Z...
TMD5412RI-U	0.236	12.400	12	12.990	2.480	2.500	1.500	1.000	0.551	55.560	SD*N53Z...

Face Milling

Arbor type

TMD5410RI-U...

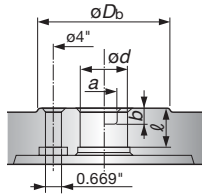

TMD5412RI-U

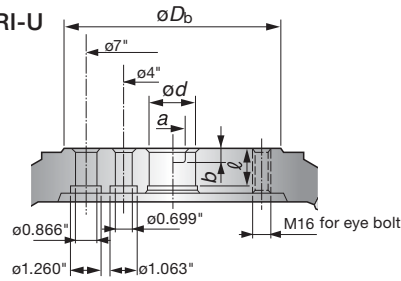

SPARE PARTS

Designation	① Locator	④ Wedge fixing screw	② Locator fixing screw	③ Wedge	Wrench
TMD54**RI-U	LD540R	FDS-8S	CM4X0.7X20	WF500R	TP-4

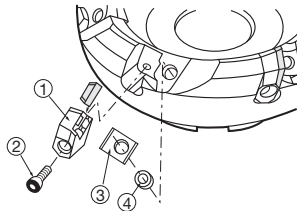

Reference pages

Inserts, Standard cutting conditions → D125

INSERT

SDCN/SDEN 53Z

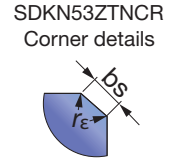
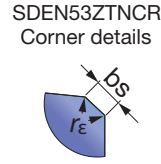
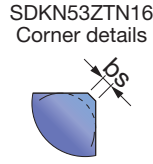
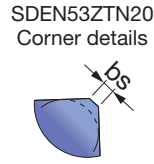
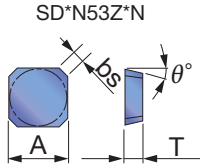

SDKR53-MJ

SDKR53ZSR-MJ
(With 3-dimensional chipbreaker)

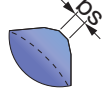
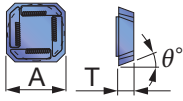

P	Steel	☆		☆	★	★	☆	☆						
M	Stainless		★	☆										
K	Cast iron	★												
N	Non-ferrous									★				
S	Superalloys	★	☆											
H	Hard materials													

★ : First choice
☆ : Second choice

Designation	Max. ap	Coated					Cermet		Uncoated		A	T	θ°	bs
		AH120	AH130	AH140	GH330	T3130	NS740	N308	UX30	TH10				
SDCN53ZTN	0.236						●	●			0.625	0.187	15	0.047
SDEN53ZFN	0.236								●		0.625	0.187	15	0.047
SDEN53ZTN	0.236				●		●		●		0.625	0.187	15	0.047
SDEN53ZTNCR	0.236						●				0.625	0.187	15	0.055
SDEN53ZTN20	0.236				●						0.625	0.187	15	0.079
SDKN53ZFN	0.236								●		0.625	0.187	15	0.047
SDKN53ZTN	0.236	●	●	●	●		●	●	●		0.625	0.187	15	0.047
SDKN53ZTNCR	0.236						●				0.625	0.187	15	0.063
SDKN53ZTN16	0.236				●						0.625	0.187	15	0.063
SDKR53ZSR-MJ	0.236				●	●					0.625	0.187	15	0.079



● : Line up

STANDARD CUTTING CONDITIONS

ISO	Workpiece material	Grade	Roughing (Depth of cut: ap 0.059" ~ 0.236")		Finishing (Depth of cut: ap 0.012" ~ 0.028")	
			Cutting speed vc (sfm)	Feed per tooth fz (ipt)	Cutting speed vc (sfm)	Feed per tooth fz (ipt)
P	Mild steels Unhardened steels < 180 HB	NS740	492 ~ 820	0.004 ~ 0.010	492 ~ 820	0.004 ~ 0.012
		AH120	492 ~ 820	0.004 ~ 0.014	492 ~ 820	0.004 ~ 0.014
		T3130	492 ~ 984	0.004 ~ 0.014	591 ~ 984	0.004 ~ 0.014
	Carbon steels Alloy steels < 300 HB	AH130	328 ~ 591	0.004 ~ 0.014	427 ~ 656	0.004 ~ 0.014
		T3130	492 ~ 919	0.004 ~ 0.014	591 ~ 919	0.004 ~ 0.014
		NS740	328 ~ 591	0.004 ~ 0.010	492 ~ 656	0.004 ~ 0.012
Die steels < 30 HRC	AH120	328 ~ 656	0.004 ~ 0.012	492 ~ 656	0.004 ~ 0.014	
M	Stainless steels < 250 HB	T3130 · AH120	328 ~ 492	0.004 ~ 0.008	328 ~ 492	0.004 ~ 0.008
		AH130 · AH140	262 ~ 591	0.006 ~ 0.012	328 ~ 656	0.006 ~ 0.013
K	Cast irons, Ductile cast irons	AH120 · GH330	492 ~ 755	0.006 ~ 0.012	656 ~ 820	0.006 ~ 0.012
		AH120	328 ~ 656	0.004 ~ 0.012	328 ~ 656	0.004 ~ 0.012
N	Aluminum alloys Si < 13%	TH10	656 ~ 3281	0.002 ~ 0.012	1148 ~ 3281	0.004 ~ 0.012
	Copper alloys	TH10	656 ~ 1640	0.004 ~ 0.008	656 ~ 1640	0.004 ~ 0.010

Notes: • Dry cutting is recommended for all materials except for aluminum alloys.
• When wet machining mild steels, carbon steels and alloy steels, use T3130 at lower cutting conditions.

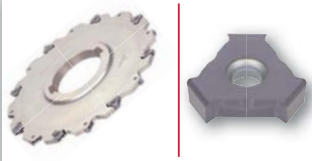
MillLine - Slot Milling

				Inch	Metric
	<p>TUNGMSLIT</p> <p>Thin width slitting cutter with self-clamping insert</p> <p>ø2.480" - ø4.921" (ø63 - ø125 mm), Slot width 0.063" - 0.161" (1.6 - 4.1 mm)</p> <p>P M K</p>	D128	<input checked="" type="checkbox"/>	<input checked="" type="checkbox"/>	
	<p>TUNGTHINSLIT</p> <p>Slot milling cutters available in axial drive type working with 6-cornered tangentially mounted inserts</p> <p>ø3" - ø8" (ø80 - ø160 mm), Slot width 0.250" - 0.313" (4 - 5 mm)</p> <p>P M K S</p>	D131	<input checked="" type="checkbox"/>	<input checked="" type="checkbox"/>	
	<p>TUNGUNIVERSALSLOT</p> <p>Axial and radial drive type slot milling cutters with 6-cornered radially mounted inserts</p> <p>ø3" - ø6", Slot width 0.375" - 0.625"</p> <p>P M K S</p>	D133	<input checked="" type="checkbox"/>	<input type="checkbox"/>	
	<p>TECTANGENTIALSLIT</p> <p>Axial and radial drive type slot milling cutters for wider slots with tangentially mounted inserts</p> <p>ø3.937" - ø9.843", Slot width 0.630" - 0.984"</p> <p>P M K S</p>	D136	<input checked="" type="checkbox"/>	<input type="checkbox"/>	

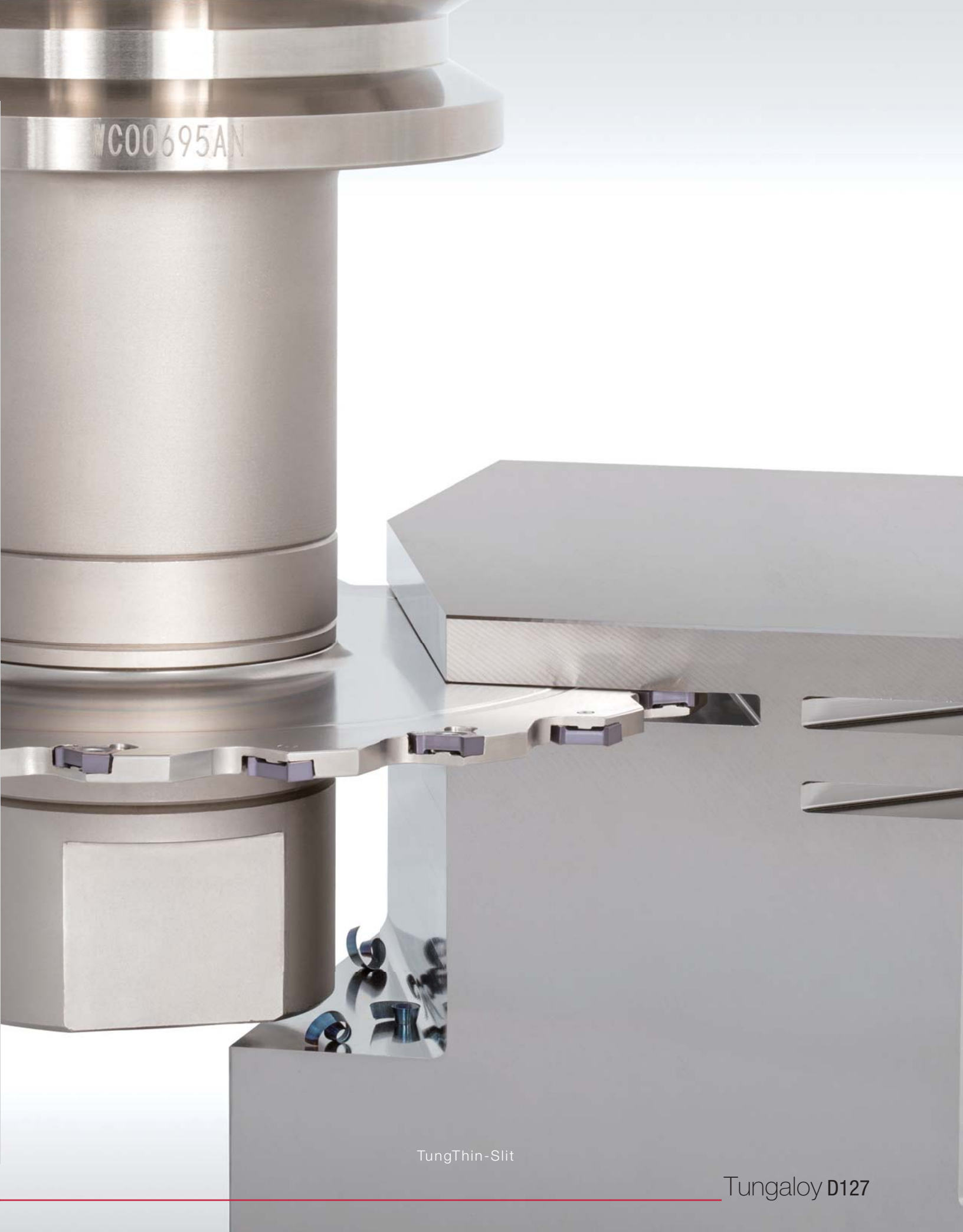

WC00695AN

TungThin-Slit

Tungaloy D127

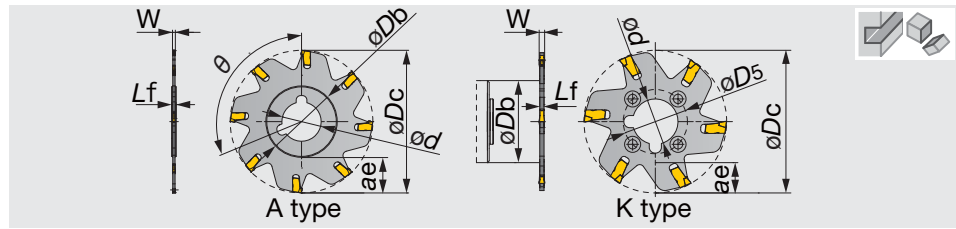

Metric	W min	W max	oDc	z	oDb	od	oD5	Lf	Max. ae	θ°	SS	SS	Drive flange	type	Insert
SSG01R063-E1.6	1.6	1.6	63	6	32	10	22	2.4	15	0	SW25-32	SW1.00-32	-	K	SSS16N
ASG01N076-1.6	1.6	1.6	76.2	8	39	25.4	-	2.4	14	112.5	-	-	-	A	SSS16N
ASG01N080-E1.6	1.6	1.6	80	8	39	22	-	2.4	16	112.5	-	-	-	A	SSS16N
ASG01N100-1.6	1.6	1.6	100	10	39	25.4	-	2.4	30	90	-	-	-	A	SSS16N
ASG01N100-E1.6	1.6	1.6	100	10	39	22	-	2.4	30	90	-	-	-	A	SSS16N
ASG01N125-1.6	1.6	1.6	125	12	64	31.75	-	2.4	30	75	-	-	-	A	SSS16N
ASG01N125-E1.6	1.6	1.6	125	12	64	27	-	2.4	30	75	-	-	-	A	SSS16N
SSG02R063-E2	1.85	2.5	63	6	32	10	22	2.4	15	0	SW25-32	SW1.00-32	-	K	SSM/S22N
ASG02N076-2	1.85	2.5	76.2	8	39	25.4	-	2.4	17	112.5	-	-	-	A	SSM/S22N
ASG02N080-E2	1.85	2.5	80	8	39	22	-	2.4	20	112.5	-	-	-	A	SSM/S22N
ASG02N100-2	1.85	2.5	100	10	39	25.4	-	2.4	30	90	-	-	-	A	SSM/S22N
ASG02N100-E2	1.85	2.5	100	10	39	22	-	2.4	30	90	-	-	-	A	SSM/S22N
ASG02N125-2	1.85	2.5	125	12	60	31.75	-	2.4	32	75	-	-	-	A	SSM/S22N
ASG02N125-E2	1.85	2.5	125	12	60	27	-	2.4	32	75	-	-	-	A	SSM/S22N
SSG03R063-E3	2.65	3.5	63	5	32	10	22	2.4	15	0	SW25-32	SW1.00-32	-	K	SSM/S31N
SSG03R080-3	2.65	3.5	80	6	46	25.4	36	2.4	16	0	SW32-25.4-46-J	SW1.25-46	R1.00-46	K	SSM/S31N
SSG03R080-E3	2.65	3.5	80	6	40 ⁽¹⁾	22	32	2.4	19 ⁽²⁾	0	SW32-40	-	R22-46	K	SSM/S31N
SSG03R100-3	2.65	3.5	100	6	46	25.4	36	2.4	26	0	SW32-25.4-46-J	SW1.25-46	R1.00-46	K	SSM/S31N
SSG03R100-E3	2.65	3.5	100	6	40 ⁽¹⁾	22	32	2.4	29 ⁽³⁾	0	SW32-40	-	R22-46	K	SSM/S31N
SSG03R125-3	2.65	3.5	125	8	55	31.75	45	2.4	34	0	-	-	R1.25-55	K	SSM/S31N
SSG03R125-E3	2.65	3.5	125	8	55	32	45	2.4	34	0	S32-55	-	R32-55	K	SSM/S31N
SSG04R063-E4	4	4.5	63	5	32	10	22	3.2	15	0	SW25-32	SW1.00-32	-	K	SSM/S41N
SSG04R080-4	4	4.5	80	6	46	25.4	36	3.2	16	0	SW32-25.4-46-J	SW1.25-46	R1.00-46	K	SSM/S41N
SSG04R080-E4	4	4.5	80	6	40 ⁽¹⁾	22	32	3.2	19 ⁽²⁾	0	SW32-40	-	R22-46	K	SSM/S41N
SSG04R100-4	4	4.5	100	6	46	25.4	36	3.2	26	0	SW32-25.4-46-J	SW1.25-46	R1.00-46	K	SSM/S41N
SSG04R100-E4	4	4.5	100	6	40 ⁽¹⁾	22	32	3.2	29 ⁽³⁾	0	SW32-40	-	R22-46	K	SSM/S41N
SSG04R125-4	4	4.5	125	8	55	31.75	45	3.2	34	0	-	-	R1.25-55	K	SSM/S41N
SSG04R125-E4	4	4.5	125	8	55	32	45	3.2	34	0	S32-55	-	R32-55	K	SSM/S41N

(1) When using a drive flange, oDb = 46 mm
 (2) When using a drive flange, Max. ae = 16 mm
 (3) When using a drive flange, Max. ae = 26 mm

SPARE PARTS



Designation	Extractor
SSG01/02...	ESG 0.5
ASG01/02...	ESG 0.5
SSG03/04...	ESG1

Reference pages

Inserts, Standard cutting conditions → **D129**

INSERT

SSM

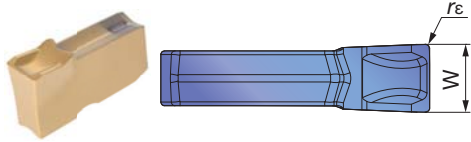

SSS

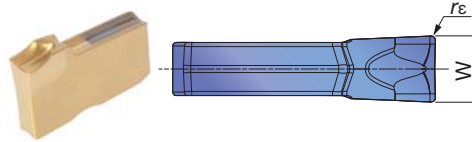

P Steel	★	
M Stainless	★	
K Cast iron	★	
N Non-ferrous		
S Superalloys		
H Hard materials		

★ : First choice
☆ : Second choice

Designation	rε	Coated										W±0.002	
		GH130											
SSM22N	0.008	●											0.087
SSM31N	0.008	●											0.122
SSM41N	0.010	●											0.161
SSS16N	0.006	●											0.063
SSS22N	0.008	●											0.087
SSS31N	0.008	●											0.122
SSS41N	0.010	●											0.161

● : Line up

STANDARD CUTTING CONDITIONS

ISO	Work piece materials	Hardness (HB)	Insert	Cutting speed Vc (sfm)	Chip thickness t (in)
P	Low carbon steel (1015, etc.)	- 200	SSM...	490 - 760	0.0020 - 0.006
	High carbon steel (1045, etc.)	200 - 300	SSM...	330 - 560	0.0016 - 0.005
	Alloy steel (4140, etc.)	150 - 300	SSM...	300 - 530	0.0016 - 0.005
	Tool steel (D2, etc.)	- 300	SSM...	230 - 390	0.0016 - 0.005
M	Stainless steel (304, etc.)	-	SSS...	300 - 660	0.0016 - 0.005
K	Gray cast iron (No250B, etc.)	150 - 250	SSM...	330 - 660	0.0020 - 0.006
	Ductile cast iron (65-45-12, etc.)	150 - 250	SSM...	260 - 430	0.0020 - 0.006



Slot Milling

TUNGMSLIT

R (drive flange set)

Drive flange set for side cutters

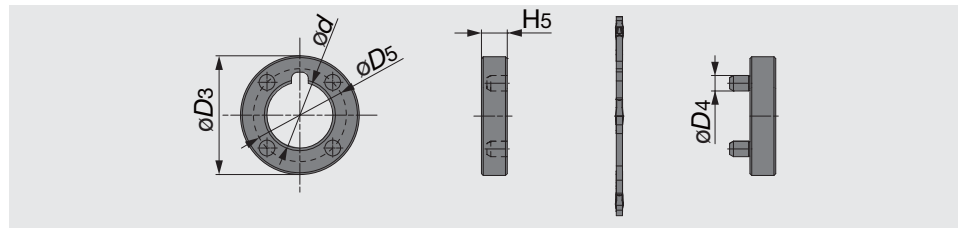

Inch	ϕd	$\phi D3$	$\phi D4$	$\phi D5$	H5
R1.00-46	1.000	1.811	0.197	1.417	0.394
R1.25-55	1.250	2.165	0.236	1.772	0.394
Metric	ϕd	$\phi D3$	$\phi D4$	$\phi D5$	H5
R22-46	22	46	6	32	10
R32-55	32	55	6	45	10

TUNGMSLIT

SW/S

Drive shanks for side cutters

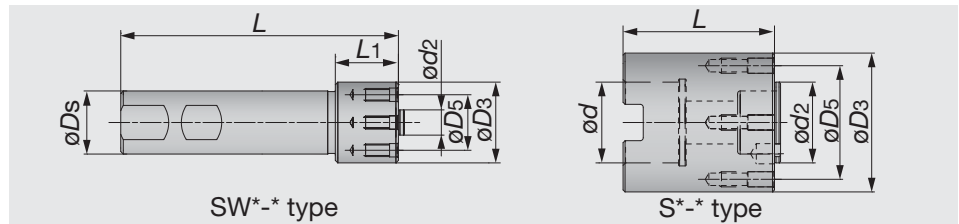

Inch	ϕD_s	ϕd	$\phi d2$	$\phi D3$	$\phi D5$	L1	L
SW1.00-32	1.000	-	0.394	1.260	0.866	1.000	4.331
SW1.25-46	1.250	-	1.000	1.811	1.417	1.181	4.724
S1.25-55	-	1.250	1.250	2.165	1.772	-	2.362
Metric	ϕD_s	ϕd	$\phi d2$	$\phi D3$	$\phi D5$	L1	L
SW25-32	25	-	10	32	22	25	110
SW32-40	32	-	22	40	32	30	120
SW32-25.4-46-J	32	-	25.4	46	36	30	120
S32-55	-	32	32	55	45	-	60

SPARE PARTS



Designation	Screw	Wrench		
		Mono block type	Torx bit	Handle
SW25-32	SR76-961	SETT-15/5	-	-
SW32-40	SR76-963	SETT-15/5	-	-
SW32-25.4-46-J	SR76-963	SETT-15/5	-	-
SW1.00-32	SR76-961	SETT-15/5	-	-
SW1.25-46	SR76-963	SETT-15/5	-	-
S1.25-55	SR76-943	-	BT20M	H-TB
S32-55	SR76-943	-	BT20M	H-TB

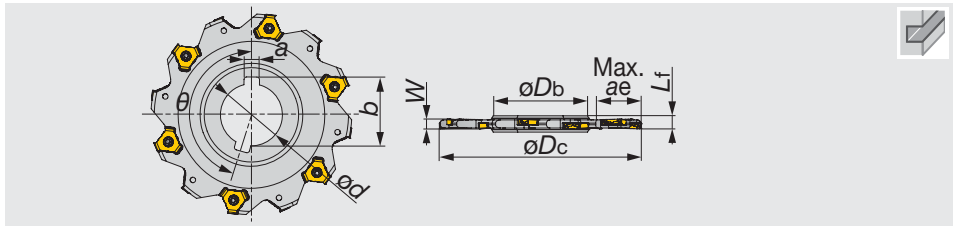

Metric	W	ϕD_c	Edge/Z	ϕD_b	ϕd	Lf	b	a	Max. ae	θ°	Insert
ASV02N080-4	4	80	5/10	41	25.4	6	28	6.35	15	162	TVKX0202...
ASV02N080-E4	4	80	5/10	41	27	6	29.8	7	15	162	TVKX0202...
ASV02N100-4	4	100	6/12	48	31.75	6	35.2	7.92	20	165	TVKX0202...
ASV02N100-E4	4	100	6/12	47	32	6	34.8	8	20	165	TVKX0202...
ASV02N125-4	4	125	8/16	58	38.1	6	42.3	9.52	30	168.75	TVKX0202...
ASV02N125-E4	4	125	8/16	55	40	6	43.5	10	30	168.75	TVKX0202...
ASV02N160-4	4	160	10/20	58	38.1	6	42.3	9.52	45	171	TVKX0202...
ASV02N160-E4	4	160	10/20	55	40	6	43.5	10	45	171	TVKX0202...
ASV03N080-5	5	80	5/10	41	25.4	6.5	28	6.35	15	162	TVKX03X3...
ASV03N080-E5	5	80	5/10	41	27	6.5	29.8	7	15	162	TVKX03X3...
ASV03N100-5	5	100	6/12	48	31.75	6.5	35.2	7.92	20	165	TVKX03X3...
ASV03N100-E5	5	100	6/12	47	32	6.5	34.8	8	20	165	TVKX03X3...
ASV03N125-5	5	125	8/16	58	38.1	6.5	42.3	9.52	30	168.75	TVKX03X3...
ASV03N125-E5	5	125	8/16	55	40	6.5	43.5	10	30	168.75	TVKX03X3...
ASV03N160-5	5	160	10/20	58	38.1	6.5	42.3	9.52	45	171	TVKX03X3...
ASV03N160-E5	5	160	10/20	55	40	6.5	43.5	10	45	171	TVKX03X3...

SPARE PARTS



Designation	Clamping screw	Lubricant	Wrench
ASV02/03N...	SR114-018-L3.40	M-1000	T-6D

Inch	W	ϕD_c	Edge/Z	ϕD_b	ϕd	Lf	b	a	Max. ae	θ°	Insert
ASV04N300-U025	0.250	3.000	4/8	1.614	1.000	0.394	1.102	0.250	0.595	157.5	TVKX04H3**
ASV04N400-U025	0.250	4.000	5/10	1.890	1.250	0.394	1.386	0.312	0.957	162	TVKX04H3**
ASV04N500-U025	0.250	5.000	6/12	2.283	1.500	0.394	1.665	0.375	1.260	165	TVKX04H3**
ASV04N600-U025	0.250	6.000	8/16	2.283	1.500	0.394	1.665	0.375	1.760	168.75	TVKX04H3**
ASV04N800-U025	0.250	8.000	10/20	2.717	2.000	0.394	2.197	0.500	2.543	171	TVKX04H3**
ASV05N300-U031	0.313	3.000	4/8	1.614	1.000	0.472	1.102	0.250	0.595	157.5	TVKX0504**
ASV05N400-U031	0.313	4.000	5/10	1.890	1.250	0.472	1.386	0.312	0.957	162	TVKX0504**
ASV05N500-U031	0.313	5.000	6/12	2.283	1.500	0.472	1.665	0.375	1.260	165	TVKX0504**
ASV05N600-U031	0.313	6.000	8/16	2.283	1.500	0.472	1.665	0.375	1.760	168.75	TVKX0504**
ASV05N800-U031	0.313	8.000	10/20	2.717	2.000	0.472	2.197	0.500	2.543	171	TVKX0504**

SPARE PARTS



Designation	Clamping screw	Torx bit	Grip
ASV04N...	SR14-500/L5.1	BT15S	H-TBS
ASV05N...	SR14-500-L7.0	BT15S	H-TBS

Reference pages

Inserts, Standard cutting conditions → **D132**

Slot Milling

INSERT

TVKX-MJ

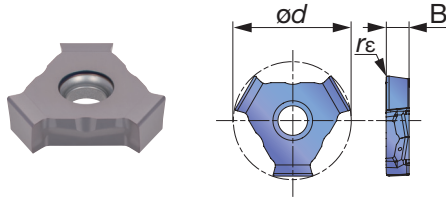

P Steel	☆	★	
M Stainless		★	☆
K Cast iron	★		☆
N Non-ferrous			
S Superalloys	★	☆	★
H Hard materials			

★ : First choice
☆ : Second choice

Designation	rε	Coated			B	ød
		AH120	AH130	AH725		
TVKX020202TN-MJ	0.008	●		●	0.094	0.370
TVKX03X302TN-MJ	0.008	●		●	0.126	0.370
TVKX04H304TN-MJ	0.016	●	●	●	0.138	0.665
TVKX04H308TN-MJ	0.031	●	●	●	0.138	0.665
TVKX050404TN-MJ	0.016	●	●	●	0.177	0.665
TVKX050408TN-MJ	0.031	●	●	●	0.177	0.665

● : Line up



Slot Milling





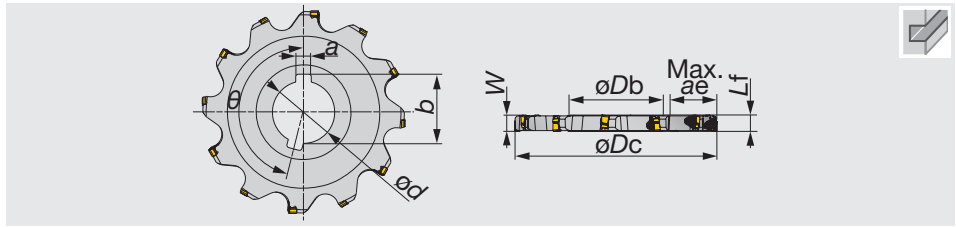

STANDARD CUTTING CONDITIONS

ISO	Workpiece material	Hardness (HB)	Priority	Grade	Cutting speed Vc (sfm)	Feed per edge line: fz (ipt)			
						ASV		ASV	
						ae / øDc (in)		ae / øDc (in)	
						10%	20%	30%	≤ 50%
P	Low carbon steel (1015, etc.)	- 200	First choice	AH725	300 - 590	0.0031 - 0.0098	0.0024 - 0.0075	0.0020 - 0.0063	0.0020 - 0.0059
		- 200	For impact resistance	AH130	300 - 590	0.0031 - 0.0098	0.0024 - 0.0075	0.0020 - 0.0063	0.0020 - 0.0059
	High carbon steel (1045, etc.)	200 - 300	First choice	AH725	300 - 590	0.0028 - 0.0087	0.0020 - 0.0063	0.0016 - 0.0055	0.0016 - 0.0051
		200 - 300	For impact resistance	AH130	300 - 590	0.0028 - 0.0087	0.0020 - 0.0063	0.0016 - 0.0055	0.0016 - 0.0051
	Alloy steel (4140, etc.)	150 - 300	First choice	AH725	300 - 590	0.0028 - 0.0087	0.0020 - 0.0063	0.0016 - 0.0055	0.0016 - 0.0051
		150 - 300	For impact resistance	AH130	300 - 590	0.0028 - 0.0087	0.0020 - 0.0063	0.0016 - 0.0055	0.0016 - 0.0051
Tool steel (D2, etc.)	- 300	First choice	AH725	300 - 590	0.0028 - 0.0087	0.0020 - 0.0063	0.0016 - 0.0055	0.0016 - 0.0051	
	- 300	For impact resistance	AH130	300 - 590	0.0028 - 0.0087	0.0020 - 0.0063	0.0016 - 0.0055	0.0016 - 0.0051	
M	Stainless steel (304, etc.)	-	-	AH130	300 - 660	0.0028 - 0.0087	0.0020 - 0.0063	0.0016 - 0.0055	0.0016 - 0.0051
K	Gray cast iron (No250B, etc.)	150 - 250	-	AH120	390 - 760	0.0031 - 0.0098	0.0024 - 0.0075	0.0020 - 0.0063	0.0020 - 0.0059
	Ductile cast iron (65-45-12, etc.)	150 - 250	-	AH120	300 - 490	0.0031 - 0.0098	0.0024 - 0.0075	0.0020 - 0.0063	0.0020 - 0.0059
S	Titanium alloys (Ti-6Al-4V, etc.)	-	First choice	AH725	100 - 130	0.0028 - 0.0047	0.0020 - 0.0035	0.0016 - 0.0028	0.0016 - 0.0028
		-	For impact resistance	AH130	100 - 130	0.0028 - 0.0047	0.0020 - 0.0035	0.0016 - 0.0028	0.0016 - 0.0028
	Nickel-based alloys (Inconel 718, etc.)	-	First choice	AH725	70 - 120	0.0028 - 0.0047	0.0020 - 0.0035	0.0016 - 0.0028	0.0016 - 0.0028
		-	For impact resistance	AH130	70 - 120	0.0028 - 0.0047	0.0020 - 0.0035	0.0016 - 0.0028	0.0016 - 0.0028



Inch	W	ϕD_c	Edge/Z	ϕD_b	ϕd	L _f	b	a	Max. ae	θ°	Insert
ASW06N300-U037	0.375	3.000	4/8	1.614	1.000	0.375	1.102	0.250	0.654	157.5°	WNGU0603**
ASW06N400-U037	0.375	4.000	5/10	1.890	1.250	0.375	1.386	0.312	1.016	162°	WNGU0603**
ASW06N500-U037	0.375	5.000	6/12	2.283	1.500	0.375	1.665	0.375	1.319	165°	WNGU0603**
ASW06N600-U037	0.375	6.000	7/14	2.283	1.500	0.375	1.665	0.375	1.819	167.14°	WNGU0603**
ASW07N400-U050	0.500	4.000	5/10	1.890	1.250	0.500	1.386	0.312	1.016	162°	WNGU07T3**
ASW07N500-U050	0.500	5.000	6/12	2.283	1.500	0.500	1.665	0.375	1.319	165°	WNGU07T3**
ASW07N600-U050	0.500	6.000	7/14	2.283	1.500	0.500	1.665	0.375	1.819	167.14°	WNGU07T3**
ASW09N600-U062	0.625	6.000	7/14	2.283	1.500	0.625	1.665	0.375	1.819	167.14°	WNGU0904**

SPARE PARTS

Designation							
	Clamping screw	Clamping screw 1	Grip	Grip 1	Torx bit	Wrench	Lubricant
ASW06N...	-	CSPB-2.5	-	-	-	IP-8D	M-1000
ASW07N400...	-	CSPD-3	-	SW6-SD	BLD IP10/S7	-	M-1000
ASW07N500...	-	CSPD-3	-	SW6-SD	BLD IP10/S7	-	M-1000
ASW07N600...	-	CSPD-3	-	-	-	IP-10D	M-1000
ASW09N400...	CSPB-3.5	-	H-TBS	-	BLD IP15/S7	-	M-1000
ASW09N600...	CSPB-3.5	-	-	-	-	IP-15D	M-1000

Reference pages

Inserts → **D134**, Standard cutting conditions → **D135**



Slot Milling

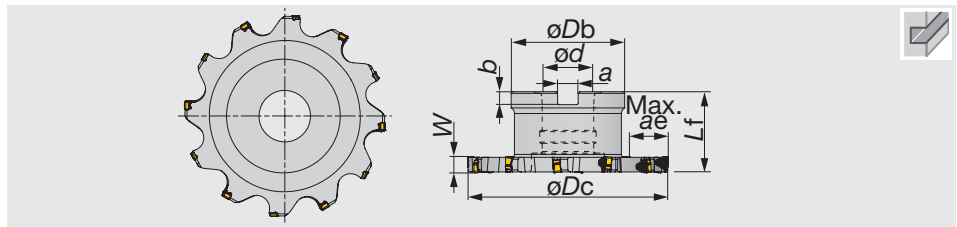

Inch	W	øDc	Edge/Z	øDb	ød	Lf	b	a	Max. ae	Insert
TSW06R400-U037	0.375	4.000	5/10	1.969	1.000	1.969	0.236	0.374	0.976	WNGU0603...
TSW06R500-U037	0.375	5.000	6/12	2.756	1.250	1.969	0.315	0.500	1.083	WNGU0603...
TSW06R600-U037	0.375	6.000	7/14	3.937	1.500	2.480	0.394	0.626	0.992	WNGU0603...
TSW07R400-U050	0.500	4.000	5/10	1.969	1.000	1.969	0.236	0.374	0.976	WNGU07T3...
TSW07R500-U050	0.500	5.000	6/12	2.756	1.250	1.969	0.315	0.500	1.083	WNGU07T3...
TSW07R600-U050	0.500	6.000	7/14	3.937	1.500	2.480	0.394	0.626	0.992	WNGU07T3...
TSW09R600-U062	0.625	6.000	7/14	3.937	1.500	2.480	0.394	0.626	0.992	WNGU0904...

SPARE PARTS

Designation	Clamping screw	Clamping screw 1	Grip	Lubricant	Torx bit	Wrench
TSW06R...	-	CSPB-2.5	-	M-1000	-	IP-8D
TSW07R400...	-	CSPD-3	SW6-SD	M-1000	BLD IP10/S7	-
TSW07R500...	-	CSPD-3	SW6-SD	M-1000	BLD IP10/S7	-
TSW07R600...	-	CSPD-3	-	M-1000	-	IP-10D
TSW09R...	CSPB-3.5	-	-	M-1000	-	IP-15D



Slot Milling

INSERT

WNGU-MJ

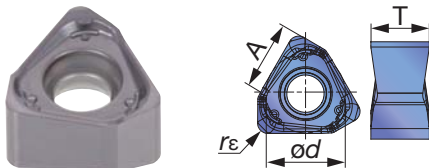

	P	M	K	N	S	H
Steel	☆		★			
Stainless		★	☆			
Cast iron	★		☆			
Non-ferrous						
Superalloys	★	☆	★			
Hard materials						

★ : First choice
☆ : Second choice

Designation	rε	Coated			A	ød	T
		AH120	AH130	AH725			
WNGU060308TN-MJ	0.031	●	●	●	0.22	0.24	0.173
WNGU060316TN-MJ	0.063	●	●	●	0.22	0.24	0.173
WNGU07T308TN-MJ	0.031	●	●	●	0.268	0.291	0.217
WNGU07T316TN-MJ	0.063	●	●	●	0.268	0.291	0.217
WNGU090408TN-MJ	0.031	●	●	●	0.335	0.339	0.256
WNGU090416TN-MJ	0.063	●	●	●	0.335	0.339	0.256

● : Line up

Reference pages

Standard cutting conditions → **D135**

STANDARD CUTTING CONDITIONS

ISO	Workpiece material	Hardness (HB)	Priority	Grade	Cutting speed Vc (sfm)	Feed per edge line: fz (ipt)			
						TSW / ASW			
						ae / øDc (in)			
10%	20%	30%	≤ 50%						
P	Low carbon steel (1015, etc.)	- 200	First choice	AH725	300 - 590	0.0047 - 0.0130	0.0035 - 0.0098	0.0028 - 0.0083	0.0028 - 0.0079
		- 200	For impact resistance	AH130	300 - 590	0.0047 - 0.0130	0.0035 - 0.0098	0.0028 - 0.0083	0.0028 - 0.0079
	High carbon steel (1045, etc.)	200 - 300	First choice	AH725	300 - 590	0.0047 - 0.0130	0.0035 - 0.0098	0.0028 - 0.0083	0.0028 - 0.0079
		200 - 300	For impact resistance	AH130	300 - 590	0.0047 - 0.0130	0.0035 - 0.0098	0.0028 - 0.0083	0.0028 - 0.0079
	Alloy steel (4140, etc.)	150 - 300	First choice	AH725	300 - 590	0.0047 - 0.0130	0.0035 - 0.0098	0.0028 - 0.0083	0.0028 - 0.0079
		150 - 300	For impact resistance	AH130	300 - 590	0.0047 - 0.0130	0.0035 - 0.0098	0.0028 - 0.0083	0.0028 - 0.0079
Tool steel (D2, etc.)	- 300	First choice	AH725	300 - 590	0.0047 - 0.0130	0.0035 - 0.0098	0.0028 - 0.0083	0.0028 - 0.0079	
	- 300	For impact resistance	AH130	300 - 590	0.0047 - 0.0130	0.0035 - 0.0098	0.0028 - 0.0083	0.0028 - 0.0079	
M	Stainless steel (304, etc.)	-	-	AH130	300 - 660	0.0047 - 0.0130	0.0035 - 0.0098	0.0028 - 0.0083	0.0028 - 0.0079
K	Gray cast iron (No250B, etc.)	150 - 250	-	AH120	390 - 760	0.0047 - 0.0165	0.0035 - 0.0122	0.0028 - 0.0106	0.0028 - 0.0098
	Ductile cast iron (65-45-12, etc.)	150 - 250	-	AH120	300 - 490	0.0047 - 0.0165	0.0035 - 0.0122	0.0028 - 0.0106	0.0028 - 0.0098
S	Titanium alloys (Ti-6Al-4V, etc.)	-	First choice	AH725	100 - 130	0.0039 - 0.0067	0.0031 - 0.0051	0.0024 - 0.0043	0.0024 - 0.0039
		-	For impact resistance	AH130	100 - 130	0.0039 - 0.0067	0.0031 - 0.0051	0.0024 - 0.0043	0.0024 - 0.0039
	Nickel-based alloys (Inconel 718, etc.)	-	First choice	AH725	70 - 120	0.0039 - 0.0067	0.0031 - 0.0051	0.0024 - 0.0043	0.0024 - 0.0039
		-	For impact resistance	AH130	70 - 120	0.0039 - 0.0067	0.0031 - 0.0051	0.0024 - 0.0043	0.0024 - 0.0039



Slot Milling

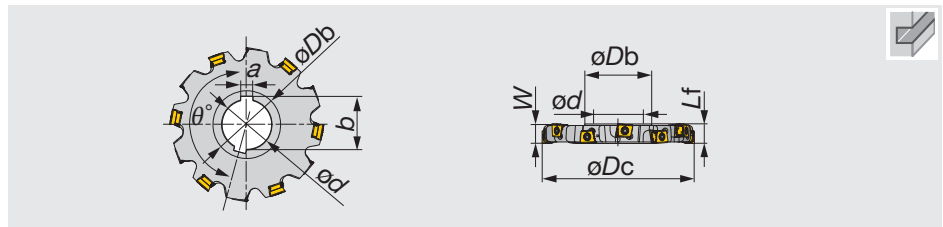

Inch	W	ϕDc	Z eff	z	ϕDb	ϕd	Lf	b	a	Max. ae	θ°	Insert
ASN10R100M31.7-16-05	0.630	3.937	5	10	1.890	1.250	0.630	1.386	0.312	0.984	162	LMEU1008**ZNEN-MJ
ASN10R125M38.1-16-06	0.630	4.921	6	12	2.283	1.500	0.630	1.665	0.375	1.280	165	LMEU1008**ZNEN-MJ
ASN10R160M38.1-16-07	0.630	6.299	7	14	2.283	1.500	0.630	1.665	0.375	1.969	167.14	LMEU1008**ZNEN-MJ
ASN12R100M31.7-19-05	0.748	3.937	5	10	1.890	1.250	0.748	1.386	0.312	0.984	162	LMEU1208**ZNEN-MJ
ASN12R125M38.1-19-06	0.748	4.921	6	12	2.283	1.500	0.748	1.665	0.375	1.280	165	LMEU1208**ZNEN-MJ
ASN12R160M38.1-19-07	0.748	6.299	7	14	2.283	1.500	0.748	1.665	0.375	1.969	167.14	LMEU1208**ZNEN-MJ
ASN15R125M38.1-25-05	0.984	4.921	5	10	2.283	1.500	0.984	1.665	0.375	1.280	162	LMEU1509**ZNEN-MJ
ASN15R160M38.1-25-06	0.984	6.299	6	12	2.283	1.500	0.984	1.665	0.375	1.969	165	LMEU1206**ZNEN-MJ

SPARE PARTS



Designation	Clamping screw	Grip	Torx bit
ASN10/12R...	SM40-143-H0	H-TB	BT15S
ASN15R...	CSTB-5L159	H-TB	BT20S



Slot Milling

Reference pages

Inserts, Standard cutting conditions → **D138**

TSN

Radial drive type slot milling cutter with tangentially mounted inserts

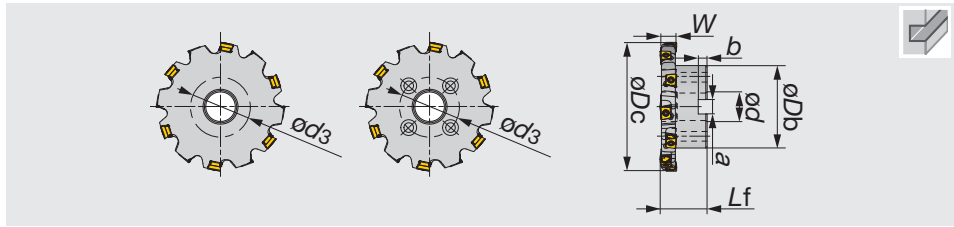

Inch	W	ϕD_c	Z eff	z	ϕD_b	ϕd	Lf	b	a	Max. ae	ϕd_3	Insert
TSN10R100M25.4-16-05	0.630	3.937	5	10	1.969	1.000	1.969	0.236	0.374	0.945	-	LMEU1008**ZNEN-MJ
TSN10R125M31.7-16-06	0.630	4.921	6	12	2.756	1.250	1.969	0.315	0.500	1.043	-	LMEU1008**ZNEN-MJ
TSN10R160M38.1-16-07	0.630	6.299	7	14	3.937	1.500	2.480	0.394	0.626	1.142	-	LMEU1008**ZNEN-MJ
TSN10R200M47.6-16-08	0.630	7.874	8	16	5.315	1.875	2.480	0.551	1.000	1.240	4.000	LMEU1008**ZNEN-MJ
TSN12R100M25.4-19-05	0.748	3.937	5	10	1.969	1.000	1.969	0.236	0.374	0.945	-	LMEU1208**ZNEN-MJ
TSN12R125M31.7-19-06	0.748	4.921	6	12	2.756	1.250	1.969	0.315	0.500	1.043	-	LMEU1208**ZNEN-MJ
TSN12R160M38.1-19-07	0.748	6.299	7	14	3.937	1.500	2.480	0.394	0.626	1.142	-	LMEU1208**ZNEN-MJ
TSN12R200M47.6-19-08	0.748	7.874	8	16	5.315	1.875	2.480	0.551	1.000	1.240	4.000	LMEU1208**ZNEN-MJ
TSN12R250M47.6-19-09	0.748	9.843	9	18	5.512	1.875	2.480	0.551	1.000	2.126	4.000	LMEU1208**ZNEN-MJ
TSN15R125M31.7-25-05	0.984	4.921	5	10	2.756	1.250	1.969	0.315	0.500	1.043	-	LMEU1509**ZNEN-MJ
TSN15R160M38.1-25-06	0.984	6.299	6	12	3.937	1.500	2.480	0.394	0.626	1.142	-	LMEU1509**ZNEN-MJ
TSN15R200M50.8-25-07	0.984	7.874	7	14	5.315	2.000	2.480	0.551	1.000	1.240	4.000	LMEU1509**ZNEN-MJ
TSN15R250M63.5-25-08	0.984	9.843	8	16	5.512	2.500	2.480	0.551	1.000	2.126	4.000	LMEU1509**ZNEN-MJ

SPARE PARTS

Designation	Clamping screw	Grip	Torx bit
TSN10/12R...	SM40-143-H0	H-TB	BT15S
TSN15R...	CSTB-5L159	H-TB	BT20S

Reference pages

Inserts, Standard cutting conditions → **D138**

Slot Milling

INSERT

LMEU-MJ

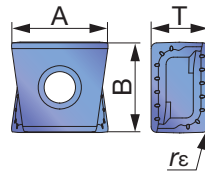

P Steel	☆	★		
M Stainless		★	☆	
K Cast iron	★		☆	
N Non-ferrous				
S Superalloys	☆	★		
H Hard materials				

★ : First choice
☆ : Second choice

Designation	rε	Coated			A	B	T
		AH120	AH140	AH725			
LMEU100808ZNEN-MJ	0.031	●	●	●	0.500	0.413	0.315
LMEU100816ZNEN-MJ	0.063	●	●	●	0.492	0.413	0.315
LMEU100824ZNEN-MJ	0.094	●	●	●	0.488	0.413	0.315
LMEU100832ZNEN-MJ	0.125	●	●	●	0.480	0.413	0.315
LMEU120808ZNEN-MJ	0.031	●	●	●	0.535	0.500	0.315
LMEU120816ZNEN-MJ	0.063	●	●	●	0.528	0.500	0.315
LMEU120824ZNEN-MJ	0.094	●	●	●	0.520	0.500	0.315
LMEU120832ZNEN-MJ	0.125	●	●	●	0.516	0.500	0.315
LMEU150908ZNEN-MJ	0.031	●	●	●	0.614	0.591	0.374
LMEU150916ZNEN-MJ	0.063	●	●	●	0.606	0.591	0.374
LMEU150924ZNEN-MJ	0.094	●	●	●	0.602	0.591	0.374
LMEU150932ZNEN-MJ	0.125	●	●	●	0.594	0.591	0.374

● : Line up



Slot Milling

STANDARD CUTTING CONDITIONS



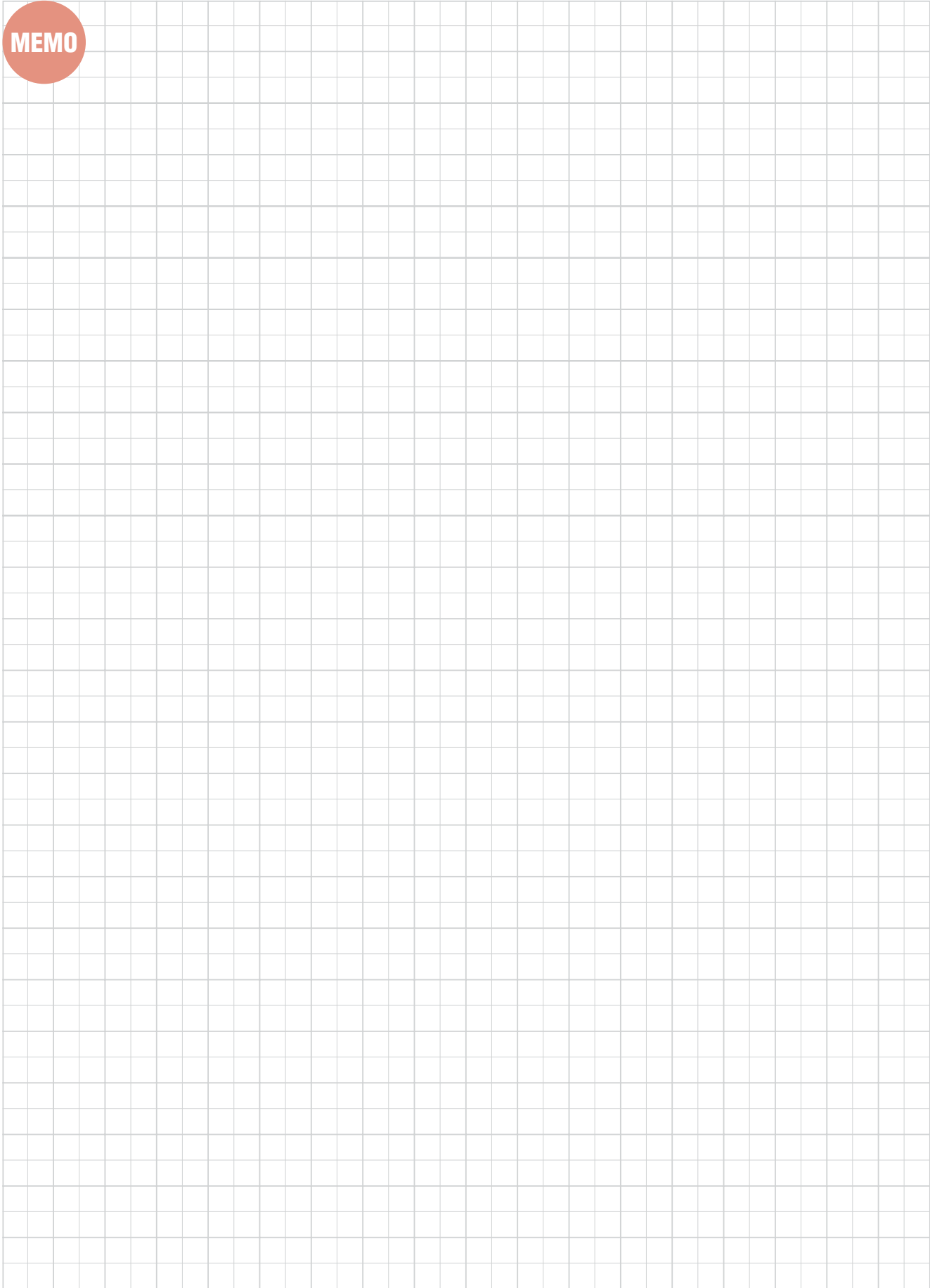

ISO	Workpiece material	Hardness (HB)	Priority	Grade	Cutting speed Vc (sfm)	Feed per edge line: fz (ipt)			
						TSN / ASN			
						ae / øDc (in)			
						10%	20%	30%	≤ 50%
P	Low carbon steel (1015, etc.)	- 200	First choice	AH725	300 - 590	0.0087 - 0.0165	0.0063 - 0.0122	0.0055 - 0.0106	0.0051 - 0.0098
		- 200	For impact resistance	AH140	300 - 590	0.0087 - 0.0165	0.0063 - 0.0122	0.0055 - 0.0106	0.0051 - 0.0098
	High carbon steel (1045, etc.)	200 - 300	First choice	AH725	300 - 590	0.0087 - 0.0165	0.0063 - 0.0122	0.0055 - 0.0106	0.0051 - 0.0098
		200 - 300	For impact resistance	AH140	300 - 590	0.0087 - 0.0165	0.0063 - 0.0122	0.0055 - 0.0106	0.0051 - 0.0098
	Alloy steel (4140, etc.)	150 - 300	First choice	AH725	300 - 590	0.0087 - 0.0165	0.0063 - 0.0122	0.0055 - 0.0106	0.0051 - 0.0098
		150 - 300	For impact resistance	AH140	300 - 590	0.0087 - 0.0165	0.0063 - 0.0122	0.0055 - 0.0106	0.0051 - 0.0098
Tool steel (D2, etc.)	- 300	First choice	AH725	300 - 590	0.0087 - 0.0165	0.0063 - 0.0122	0.0055 - 0.0106	0.0051 - 0.0098	
	- 300	For impact resistance	AH140	300 - 590	0.0087 - 0.0165	0.0063 - 0.0122	0.0055 - 0.0106	0.0051 - 0.0098	
M	Stainless steel (304, etc.)	-	-	AH140	300 - 660	0.0087 - 0.0165	0.0063 - 0.0122	0.0055 - 0.0106	0.0051 - 0.0098
K	Gray cast iron (No250B, etc.)	150 - 250	-	AH120	390 - 760	0.0087 - 0.0200	0.0063 - 0.0150	0.0055 - 0.0126	0.0051 - 0.0118
	Ductile cast iron (65-45-12, etc.)	150 - 250	-	AH120	300 - 490	0.0087 - 0.0130	0.0063 - 0.0098	0.0055 - 0.0083	0.0051 - 0.0079
S	Titanium alloys (Ti-6Al-4V, etc.)	-	First choice	AH725	100 - 130	0.0047 - 0.0087	0.0035 - 0.0063	0.0028 - 0.0055	0.0028 - 0.0051
	Nickel-based alloys (Inconel 718, etc.)	-	First choice	AH725	70 - 120	0.0047 - 0.0087	0.0035 - 0.0063	0.0028 - 0.0055	0.0028 - 0.0051

MEMO

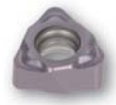

Slot Milling

MillLine - Profile Milling

				Inch	Metric
		DO TBALL Radius cutters with double-sided inserts with rigid clamping ⌀1.000" - ⌀2.000" max. ap 0.157"	D016 P M K S H	<input checked="" type="checkbox"/>	<input checked="" type="checkbox"/>
		BALL FINISH Indexable endmill for high-precision finishing with 2 effective cutting edges ⌀0.375" - ⌀1.250"	D142 P M K N H	<input checked="" type="checkbox"/>	<input checked="" type="checkbox"/>
		DOMINI MILL Double-sided positive inserts for finishing to semi-finishing in profiling operations ⌀16.0 mm - ⌀25 mm max. ap 0.039"	D148 P H	<input type="checkbox"/>	<input checked="" type="checkbox"/>
		FIXRMILL Radius cutters with single-sided inserts for profile milling of complex parts ⌀0.787" - ⌀2.598" max. ap 0.315"	D150 P M K H	<input checked="" type="checkbox"/>	<input checked="" type="checkbox"/>
		ROUNDSPLIT Radius cutters featuring single-sided inserts with serrated cutting edges for anti-chatter ⌀1.260" - ⌀4.921" max. ap 0.315"	D155 P M K N S	<input checked="" type="checkbox"/>	<input type="checkbox"/>
		Other radius mills T/ERD12/16, E/HWD	D159 P M K H	<input checked="" type="checkbox"/>	<input checked="" type="checkbox"/>
		Single Effective Tools - Ball Cutters EBP, EBD, BBB	D164 P K H	<input checked="" type="checkbox"/>	<input checked="" type="checkbox"/>

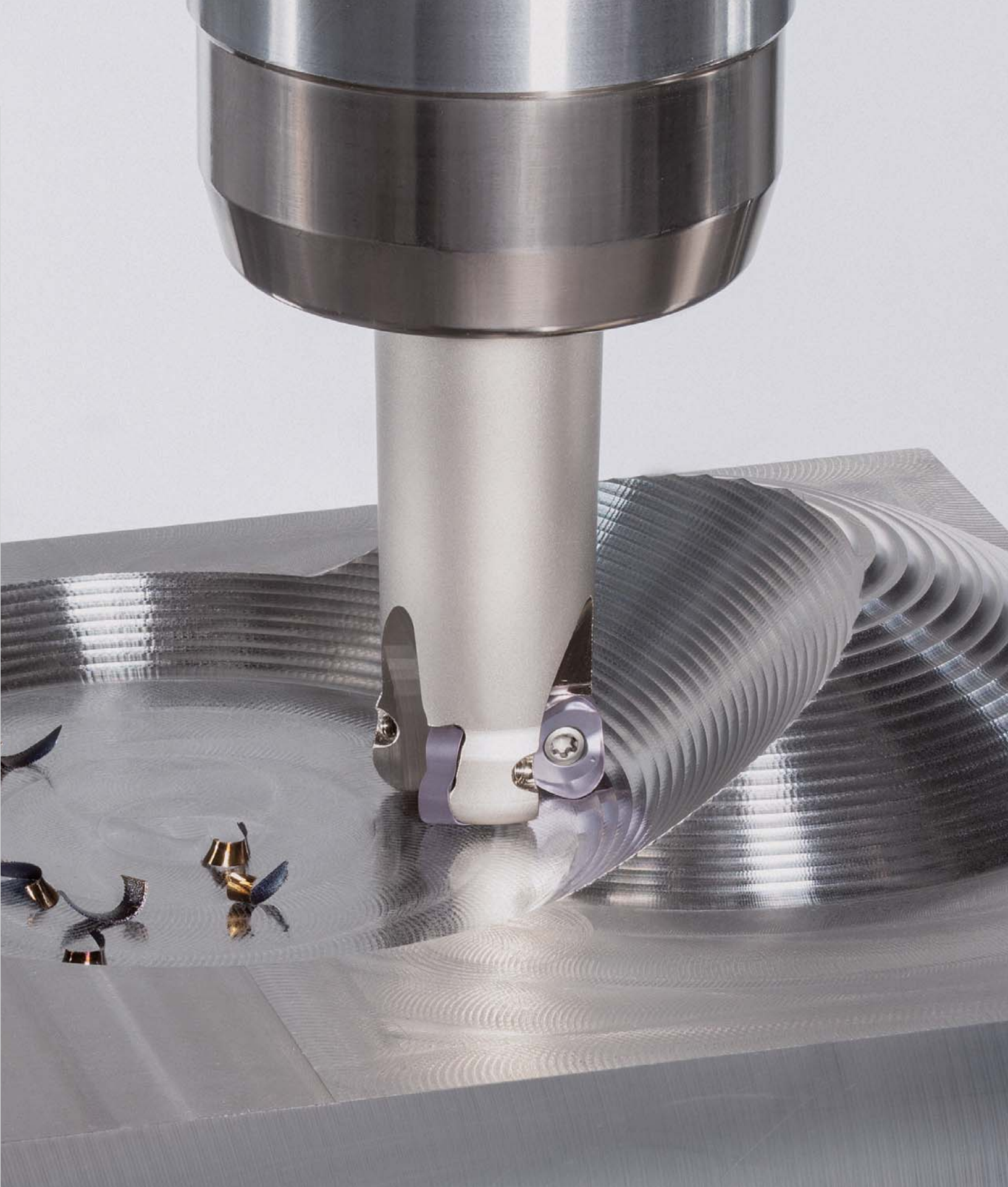

DoTwist-Ball

Tungaloy D141

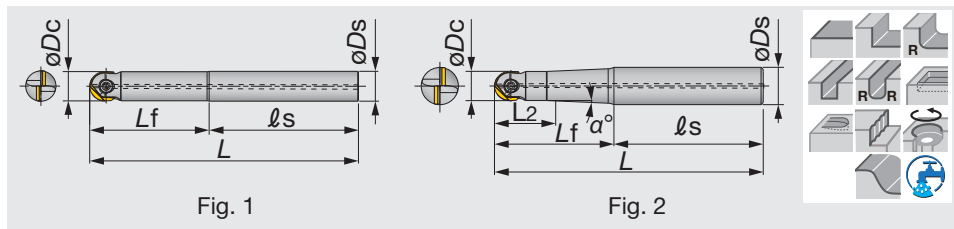

Inch	Material	ϕD_c	ϕD_s	l_s	L_f	L	L_2	α°	Air hole	Fig	Insert
EBFU037T050S0400	Steel	0.375	0.500	3.000	1.000	4.000	0.625	9.0°	with	2	ZF*U037
EBFU037S037C0550	Carbide	0.375	0.375	2.500	3.000	5.500	-	-	without	1	ZF*U037
EBFU037T062S0600	Steel	0.375	0.625	3.500	2.500	6.000	0.625	3.5°	with	2	ZF*U037
EBFU037S037C0875	Carbide	0.375	0.375	3.250	5.500	8.750	-	-	without	1	ZF*U037
EBFU050S050S0437	Steel	0.500	0.500	3.187	1.188	4.375	-	-	with	1	ZF*U050
EBFU050S050C0637	Carbide	0.500	0.500	2.750	3.625	6.375	-	-	without	1	ZF*U050
EBFU050T062S0637	Steel	0.500	0.625	4.000	2.375	6.375	1.000	2.5°	with	2	ZF*U050
EBFU050S050C0875	Carbide	0.500	0.500	2.750	6.000	8.750	-	-	without	1	ZF*U050
EBFU062T075S0500	Steel	0.625	0.750	3.000	2.000	5.000	0.563	2.0°	with	2	ZF*U062
EBFU062S062C0637	Carbide	0.625	0.625	3.375	3.000	6.375	-	-	without	1	ZF*U062
EBFU062T075S0637	Steel	0.625	0.750	3.625	2.750	6.375	0.563	1.5°	with	2	ZF*U062
EBFU062S062C0875	Carbide	0.625	0.625	2.750	6.000	8.750	-	-	without	1	ZF*U062
EBFU075T100S0700	Steel	0.750	1.000	4.000	3.000	7.000	1.563	4.5°	with	2	ZF*U075
EBFU075S075C0875	Carbide	0.750	0.750	4.000	4.750	8.750	-	-	without	1	ZF*U075
EBFU075T100S0875	Steel	0.750	1.000	4.000	4.750	8.750	1.000	1.5°	with	2	ZF*U075
EBFU075S075C1200	Carbide	0.750	0.750	3.250	8.750	12.000	-	-	without	1	ZF*U075
EBFU100T125S0800	Steel	1.000	1.250	4.000	4.000	8.000	1.250	2.5°	with	2	ZF*U100
EBFU100S100C0875	Carbide	1.000	1.000	4.000	4.750	8.750	-	-	without	1	ZF*U100
EBFU100T125S1000	Steel	1.000	1.250	4.000	6.000	10.000	1.188	1.4°	with	2	ZF*U100
EBFU100S100C1200	Carbide	1.000	1.000	3.250	8.750	12.000	-	-	without	1	ZF*U100
EBFU125S125S1000	Steel	1.250	1.250	6.000	4.000	10.000	-	-	with	1	ZF*U125
EBFU125S125C1200	Carbide	1.250	1.250	3.250	8.750	12.000	-	-	without	1	ZF*U125

SPARE PARTS

Designation	Clamping screw	Torx bit	Grip	Wrench
EBFU037...	TS30F100A	-	-	T10D
EBFU050...	TS40F120A	-	-	T15D
EBFU062...	TS50F160A	-	-	T-20
EBFU075...	TS60F200A	BLDT25/M7	SW6-T	-
EBFU100...	TS70F250A	BLDT25/M7	SW6-T	-
EBFU125...	TS70F300A	-	-	T-T30

Profile Milling

Reference pages

Inserts → **D144 - D145**, Standard cutting conditions → **D146**

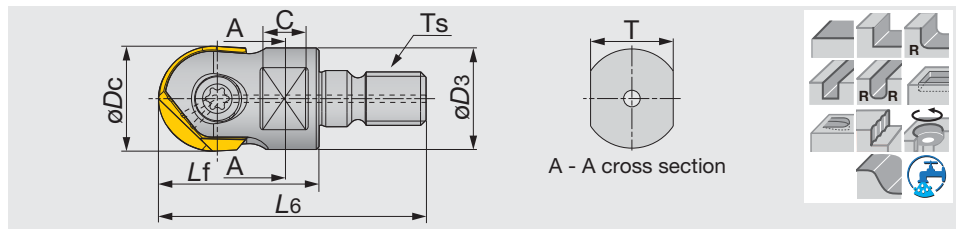

Metric	$\varnothing D_c$	L_6	L_f	C	T	$\varnothing D_3$	T_s	Air hole	Insert
HBFM10M06	10	34.5	20	5	7	9.7	M6	with	ZF*M100...
HBFM12M06	12	37.5	23	5	7	11.5	M6	with	ZF*M120...
HBFM12M08	12	40	23	8	10	13	M8	with	ZF*M120...
HBFM16M08	16	47	30	8	10	13	M8	with	ZF*M160...
HBFM20M10	20	49	30	10	15	19	M10	with	ZF*M200...
HBFM25M12	25	57	35	10	17	24	M12	with	ZF*M250...
HBFM30M16	30	66	43	12	22	29	M16	with	ZF*M300...
HBFM32M16	32	66	43	12	22	29.5	M16	with	ZF*M320...

See page D147 for TungFlex modular shank.

SPARE PARTS



Designation	Clamping screw	Torx bit	Grip	Wrench
HBFM10...	TS 30F100A	-	-	T-10D
HBFM12...	TS 40F120A	-	-	T-15D
HBFM16...	TS 50F160A	BT20S	H-TB2W	-
HBFM20...	TS 60F200A	BLDT25/M7	H-TB2W	-
HBFM25...	TS 70F250A	BLDT25/M7	H-TB2W	-
HBFM30...	TS 80F300A	-	-	T-T30
HBFM32...	TS 80F300A	-	-	T-T30

Reference pages

Inserts → [D144 - D145](#), Standard cutting conditions → [D146](#)

INSERT

ZFBU-MJ / ZFBM-MJ

ZFBU-ML

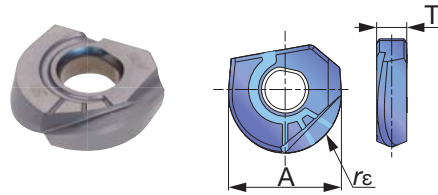
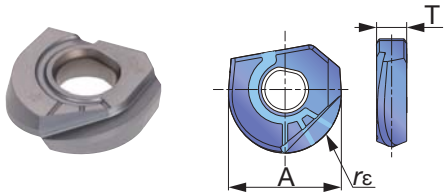

P Steel	★																			
M Stainless	☆																			
K Cast iron	☆																			
N Non-ferrous	☆																			
S Superalloys	★																			
H Hard materials	☆																			

Inch

★ : First choice
☆ : Second choice

Designation	rε	Coated										A	T	
		AH725												
ZFBU037R00-MJ	0.188	●											0.375	0.114
ZFBU050R00-MJ	0.250	●											0.500	0.134
ZFBU062R00-MJ	0.313	●											0.625	0.173
ZFBU075R00-MJ	0.375	●											0.750	0.213
ZFBU062R00-MJ	0.313	●											0.625	0.173
ZFBU100R00-MJ	0.500	●											1.000	0.252
ZFBU075R00-MJ	0.375	●											0.750	0.213
ZFBU125R00-MJ	0.625	●											1.250	0.291
ZFBU037R00-ML	0.188	●											0.375	0.114
ZFBU050R00-ML	0.250	●											0.500	0.134
ZFBU062R00-ML	0.313	●											0.625	0.173
ZFBU075R00-ML	0.375	●											0.750	0.213
ZFBU100R00-ML	0.500	●											1.000	0.252
ZFBU125R00-ML	0.625	●											1.250	0.291

● : Line up

P Steel	☆	★																		
M Stainless	☆	☆																		
K Cast iron	★	☆																		
N Non-ferrous	☆	☆																		
S Superalloys	★	★																		
H Hard materials	★	☆																		

Metric

★ : First choice
☆ : Second choice

Designation	rε	Coated										A	T	
		AH710	AH725											
ZFBM100R00-MJ	5	●	●										10	2.9
ZFBM120R00-MJ	6	●	●										12	3.4
ZFBM160R00-MJ	8	●	●										16	4.4
ZFBM200R00-MJ	10	●	●										20	5.4
ZFBM250R00-MJ	12.5	●	●										25	6.4
ZFBM300R00-MJ	15	●	●										30	7.4
ZFBM320R00-MJ	16	●	●										32	7.4

● : Line up

Profile Milling

ZFRU-MJ / ZFRM-MJ (Corner radius type)

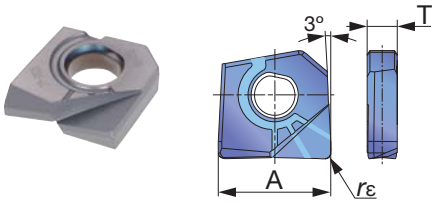

P	Steel	★																
M	Stainless	☆																
K	Cast iron	☆																
N	Non-ferrous	☆																
S	Superalloys	★																
H	Hard materials	☆																

★ : First choice
☆ : Second choice

Inch

Designation	rε	Coated										A	T		
		AH725													
ZFRU037R003-MJ	0.031	●												0.375	0.114
ZFRU050R003-MJ	0.031	●												0.500	0.134
ZFRU050R006-MJ	0.062	●												0.500	0.134
ZFRU050R012-MJ	0.125	●												0.500	0.134
ZFRU062R003-MJ	0.031	●												0.625	0.173
ZFRU062R006-MJ	0.062	●												0.625	0.173
ZFRU062R012-MJ	0.125	●												0.625	0.173
ZFRU075R003-MJ	0.031	●												0.750	0.213
ZFRU075R006-MJ	0.062	●												0.750	0.213
ZFRU075R012-MJ	0.125	●												0.750	0.213
ZFRU100R003-MJ	0.031	●												1.000	0.252
ZFRU100R006-MJ	0.062	●												1.000	0.252
ZFRU100R012-MJ	0.125	●												1.000	0.252
ZFRU125R003-MJ	0.031	●												1.250	0.291
ZFRU125R006-MJ	0.062	●												1.250	0.291
ZFRU125R012-MJ	0.125	●												1.250	0.291

● : Line up

P	Steel	☆	★															
M	Stainless	☆	☆															
K	Cast iron	★	☆															
N	Non-ferrous	☆	☆															
S	Superalloys	☆	★															
H	Hard materials	★	☆															

★ : First choice
☆ : Second choice

Metric

Designation	rε	Coated										A	T		
		AH710	AH725												
ZFRM120R05-MJ	0.5	●	●											12	3.4
ZFRM120R10-MJ	1	●	●											12	3.4
ZFRM160R05-MJ	0.5	●	●											16	4.4
ZFRM160R10-MJ	1	●	●											16	4.4
ZFRM160R15-MJ	1.5	●	●											16	4.4
ZFRM200R10-MJ	1	●	●											20	5.4
ZFRM200R15-MJ	1.5	●	●											20	5.4

● : Line up



Profile Milling

STANDARD CUTTING CONDITIONS

ISO	Workpiece materials	Hardness	Grades	Recommended		Max. axial depth of cut	Cutting speed Vc (sfm)	Feed per tooth: fz (ipt)					
				Selection criteria	Chip-breaker			øDc (in)					
								ø0.375	ø0.500	ø0.625	ø0.750	ø1.000	ø1.250
P	Low carbon steel, alloy steel	85 - 180 HB	AH725	First choice	MJ	≤0.04D	590 - 850	0.008	0.008	0.010	0.010	0.012	0.014
		85 - 180 HB	AH725	For wear resistance	ML	≤0.04D	590 - 850	0.008	0.008	0.010	0.010	0.012	0.014
	High carbon steel, alloy steel	180 - 280 HB	AH725	First choice	MJ	≤0.03D	490 - 750	0.008	0.008	0.010	0.010	0.012	0.014
		180 - 280 HB	AH725	For wear resistance	ML	≤0.03D	490 - 750	0.008	0.008	0.010	0.010	0.012	0.014
	Prehardened steel Die & mold tool steel	HRC 40 - 48	AH725	First choice	ML	≤0.03D	590 - 980	0.008	0.008	0.010	0.010	0.012	0.014
		HRC 40 - 48	AH725	For impact resistance	MJ	≤0.03D	590 - 980	0.008	0.008	0.010	0.010	0.012	0.014
M	Stainless steel	135 - 200 HB	AH725	First choice	ML	≤0.03D	330 - 820	0.006	0.008	0.008	0.010	0.010	0.012
		135 - 200 HB	AH725	For impact resistance	MJ	≤0.03D	330 - 820	0.006	0.008	0.008	0.010	0.010	0.012
K	Cast iron	150 - 240 HB	AH725	First choice	MJ	≤0.04D	300 - 1150	0.008	0.010	0.012	0.012	0.014	0.016
		150 - 240 HB	AH725	For wear resistance	ML	≤0.04D	300 - 1150	0.008	0.010	0.012	0.012	0.014	0.016
N	Aluminum	-	AH725	First choice	ML	≤0.03D	660 - 1310	0.010	0.014	0.014	0.014	0.016	0.018
		-	AH725	For impact resistance	MJ	≤0.03D	660 - 1310	0.010	0.014	0.014	0.014	0.016	0.018
H	High hardened steel	HRC 48 - 60	AH725	First choice	ML	≤0.02D	330 - 720	0.003	0.004	0.005	0.006	0.008	0.010
		HRC 48 - 60	AH725	For impact resistance	MJ	≤0.02D	330 - 720	0.003	0.004	0.005	0.006	0.008	0.010

· Remove excessive chip accumulation with an air blast.

· For the operation with depth of cut which varies (ex. casting skin) and machining of workpiece materials with interrupted surface, the feed per tooth (fz) should be set to the lower recommended value shown in the above table.

· Cutting conditions maybe limited depending on machine power, workpiece rigidity, and spindle output. When the cutting width, depth, or overhang length is large, set Vc and fz to the lower recommended values and check the machine power and vibration.



Profile Milling

How to clamp the insert

1. Clear chips and dust from the pocket.
2. Place the insert in the pocket. The insert can be placed only in one direction.
3. Tighten the screw while pressing the insert into the pocket.

How to check the run-out

1. Clamp the insert on the shank.
2. Clamp the shank on a high-precision arbor.
3. Measure the run-out on tool presetter or by dial gauge.

Notes:

1. Due to the helical cutting edge, it is important that the run-out is inspected with the insert clamped on the shank.
2. Do not use micrometer or caliper to inspect the insert diameter as inaccurate dimensions may be provided.

TungFlex

Modular shank

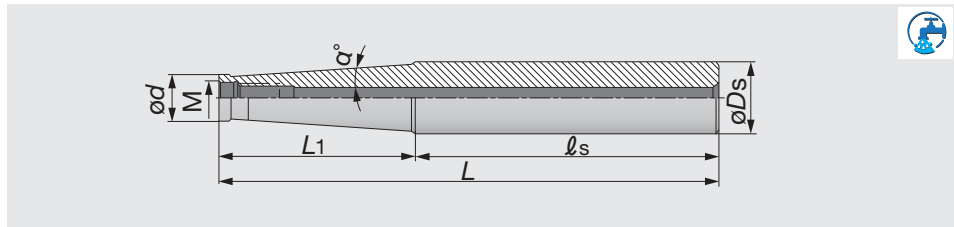

Metric	$\varnothing D_s$	L	ℓ_s	L_1	$\varnothing d$	M	α°	Shank type
SM06-L60C10	10	60	40	20	9.7	M6	0	Cylindrical
SM06-L105-C12	12	105	45	60	9.7	M6	1.2	Cylindrical
SM06-L125-C16	16	125	65	60	9.7	M6	3.3	Cylindrical
SM08-L73C16	16	73	48	25	13	M8	0	Cylindrical
SM08-L128-C16	16	128	48	80	13	M8	0.9	Cylindrical
SM08-L170-C20	20	170	103.2	66.8	13	M8	3.3	Cylindrical
SM10-L80-C20	20	80	50	30	18	M10	0	Cylindrical
SM10-L130-C20	20	130	50	80	18	M10	0.6	Cylindrical
SM10-L200-C25	25	200	142.8	57.2	19	M10	3.3	Cylindrical
SM12-L86-C25	25	86	56	30	21	M12	5.1	Cylindrical
SM12-L200-C32	32	200	122	78	21	M12	4.4	Cylindrical
SM16-L95-C32	32	95	60	35	29	M16	1.7	Cylindrical
SM16-L230-C32	32	230	180	50	29	M16	1.8	Cylindrical



Profile Milling

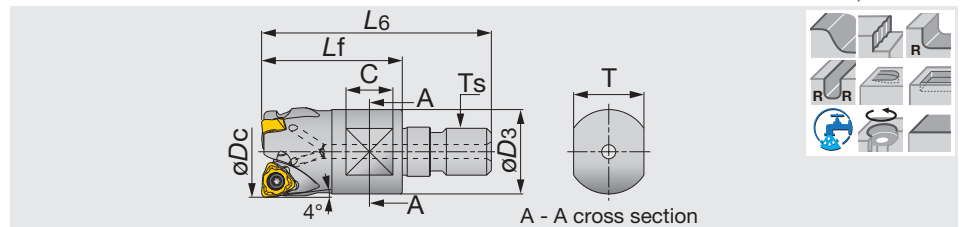

A.R. = 0°, R.R. = -14°

Metric	øDc	z	L6	Lf	C	T	øD3	Ts	Kg	Air hole	Insert
HFWX04M016M08R02	16	2	42	25	8	10	13	M8	0.03	with	WXHU04...
HFWX04M020M10R03	20	3	49	30	10	15	18	M10	0.05	with	WXHU04...
HFWX04M025M12R04	25	4	52	30	10	17	21	M12	0.09	with	WXHU04...

See page D147 for TungFlex modular shank.

SPARE PARTS

Designation	Clamping screw	Lubricant	Wrench
HFWX04M...	SR34-514	M-1000	T-7F

INSERT

WXHU-MJ

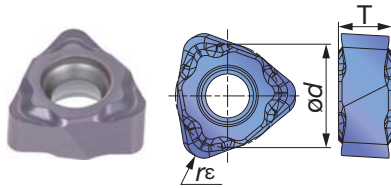

P	Steel	★
M	Stainless	
K	Cast iron	
N	Non-ferrous	
S	Superalloys	
H	Hard materials	★

★ : First choice
☆ : Second choice

Designation	re	Max. ap	Coated								ød	T
			AH110									
WXHU040305R-MJ	0.020	0.020	●								0.250	0.125
WXHU040310R-MJ	0.039	0.039	●								0.250	0.125

* For plunging, width up to 0.079" is possible.

● : Line up

STANDARD CUTTING CONDITIONS

ISO	Workpiece materials	Hardness (HB)	Grades	Cutting speed Vc (sfm)	Feed per tooth fz (ipt)
P	High carbon steel (1045, 1055, etc.)	200 - 300	AH110	328 - 984	0.004 - 0.012
	Alloy steel (4140, etc.)	150 - 300	AH110	328 - 984	0.004 - 0.012
	Prehardened steel (NAK80, PX5, etc.)	-	AH110	328 - 984	0.002 - 0.012
H	Hardened steel (H13, etc.)	-	AH110	262 - 427	0.004 - 0.012
	(D2, etc.)	-	AH110	164 - 328	0.002 - 0.006

MEMO

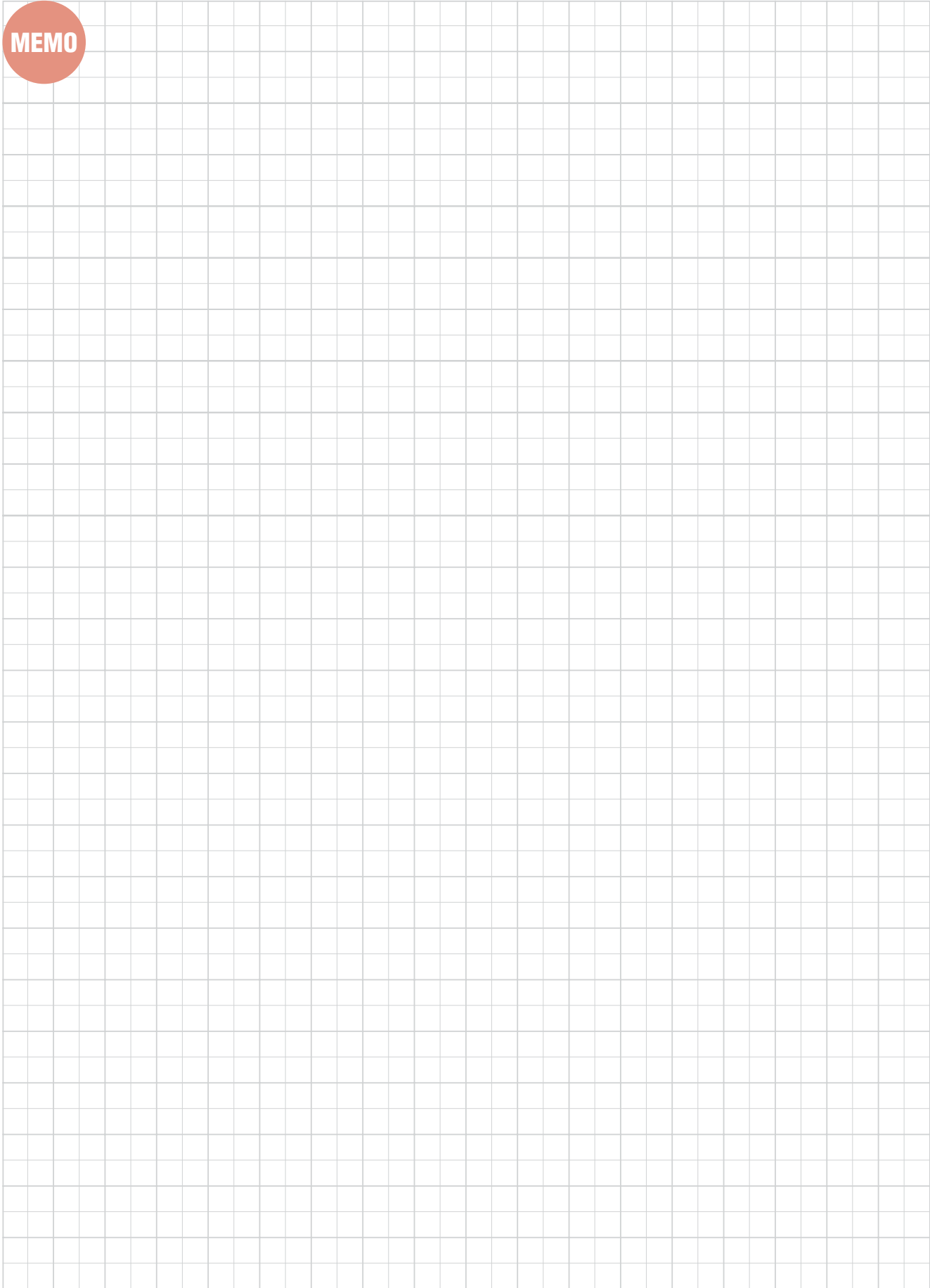

FIXRMILL

TRP12/16

Radius cutter series bore type with anti-rotation system

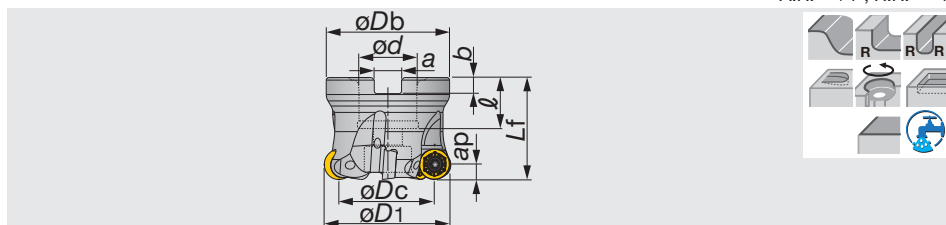

A.R. = +4°, R.R. = -4°

Inch	Max. ap	ϕD_c	z	ϕD_1	ϕD_b	ϕd	ℓ	L_f	b	a	lb	Air hole	Insert
TRP12R200U0075A05	0.236	1.526	5	2.000	1.850	0.750	0.750	1.575	0.197	0.315	0.66	with	RPMT1204EN-M*
TRP12R250U0100A06	0.236	2.026	6	2.500	2.323	1.000	1.024	1.969	0.236	0.374	1.32	with	RPMT1204EN-M*
TRP16R250U0100A05	0.315	1.869	5	2.500	2.323	1.000	1.024	1.969	0.236	0.374	1.32	with	RPMT1606EN-M*

SPARE PARTS

Designation	Clamping screw	Grip	Lubricant	Center bolt (Optional parts)	Torx bit
TRP12R...	CSTR-4L100	H-TBS	M-1000	(C0.375X1.125H)	BT15S
TRP16R...	CSPB-5	H-TBS	M-1000	(C0.375X1.125H)	BLDIP20/S7

FIXRMILL

ERP10/12/16

Radius cutter series shank type with anti-rotation system

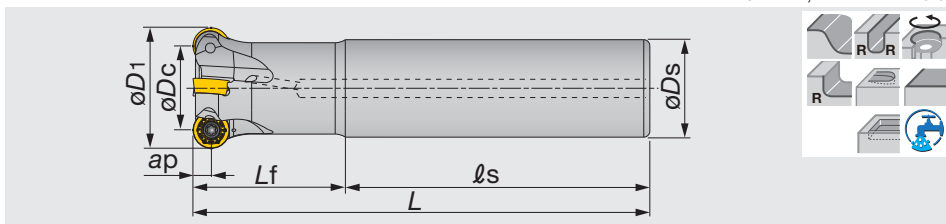

A.R. = +10°~ +4°, R.R. = -2°~ -8.5°

Inch	Max. ap	ϕD_c	z	ϕD_1	ϕD_s	ℓ_s	L_f	L	Air hole	Insert
ERP10R100U0100-02	0.197	0.776	2	1.000	1.000	4.000	2.000	6.000	with	RPMT10T3EN-M*
ERP10R125U0125-04	0.197	1.034	4	1.250	1.250	4.000	2.000	6.000	with	RPMT10T3EN-M*
ERP10R150U0125-04	0.197	0.866	4	1.500	1.250	4.000	2.000	6.000	with	RPMT10T3EN-M*
ERP12R125U0125-03	0.236	0.776	3	1.250	1.250	4.000	2.000	6.000	with	RPMT1204EN-M*
ERP12R150U0125-04	0.236	1.034	4	1.500	1.250	4.000	2.000	6.000	with	RPMT1204EN-M*
ERP16R150U0125-02	0.315	0.866	2	1.500	1.250	4.000	2.000	6.000	with	RPMT1606EN-M*

SPARE PARTS

Designation	Clamping screw	Lubricant	Wrench
ERP10R...	CSPB-3.5S	M-1000	IP-15D
ERP12R...	CSTR-4L100	M-1000	T-15DB
ERP16R...	CSPB-5	M-1000	IP-20D

Profile Milling

Reference pages

Inserts → D151, Standard cutting conditions → D152 - D153

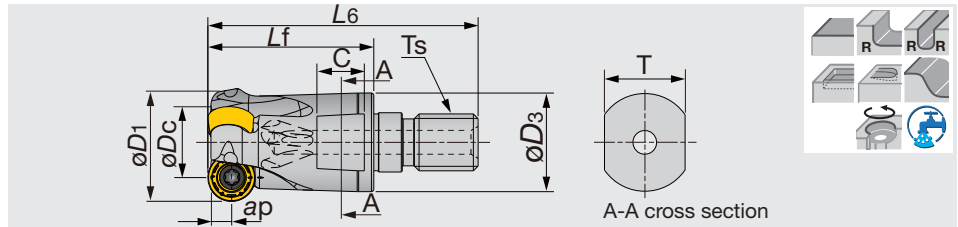

A.R. = 1°~ 4°, R.R. = -8.5°~ 2°

Metric	Max. ap	øDc	z	øD1	L6	Lf	C	T	øD3	Ts	Kg	Air hole	Insert
HRP10R020MM10-02	5	10	2	20	49	30	10	15	17.8	M10	0.1	with	RPMT10T3...
HRP10R025MM12-02	5	15	2	25	57	35	10	17	20.8	M12	0.1	with	RPMT10T3...
HRP10R032MM16-04	5	22	4	32	63	40	12	22	28.8	M16	0.2	with	RPMT10T3...
HRP12R032MM16-03	6	20	3	32	63	40	12	22	28.8	M16	0.2	with	RPMT1204...

See page D147 for TungFlex modular shank.

SPARE PARTS



Designation	Clamping screw	Lubricant	Wrench	
			Bit	Grip
HRP10R...	CSPB-3.5S	M-1000	BLD IP15/S7	H-TBS
HRP12R...	CSTR-4L100	M-1000	BT15S	H-TBS

INSERT

RPMT-MJ

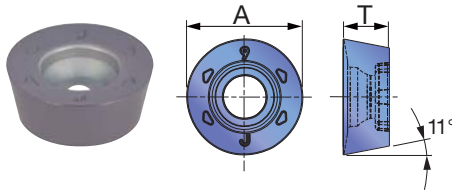

RPMT-ML

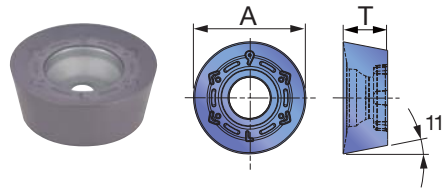

P	Steel		★									
M	Stainless	★	☆	★								
K	Cast iron		☆									
N	Non-ferrous											
S	Superalloys	☆	★									
H	Hard materials											

★ : First choice
☆ : Second choice

Designation	Max. ap	Coated			A	T
		AH130	AH725	AH4035		
RPMT10T3EN-MJ	0.197	●	●	●	0.394	0.156
RPMT10T3EN-ML	0.197	●	●	●	0.394	0.156
RPMT1204EN-MJ	0.236	●	●	●	0.472	0.187
RPMT1204EN-ML	0.236	●	●	●	0.472	0.187
RPMT1606EN-MJ	0.315	●	●	●	0.630	0.250
RPMT1606EN-ML	0.315	●	●	●	0.630	0.250

● : Line up

Reference pages

Standard cutting conditions → D152 - D153



Profile Milling

STANDARD CUTTING CONDITIONS

ISO	Workpiece material	Hardness	Priority	Grade	Chip-breaker	Cutting speed Vc (sfm)	Feed per tooth fz (ipt)
P	Carbon steels (1045, 1055 etc.)	< 300 HB	First choice	AH725	MJ	400 - 830	0.012 - 0.028
		< 300 HB	For impact resistance	AH130	MJ	400 - 830	0.012 - 0.028
	Alloy steels (4140(H) etc.)	150 - 300 HB	First choice	AH725	MJ	330 - 830	0.008 - 0.024
		150 - 300 HB	For impact resistance	AH130	MJ	330 - 830	0.008 - 0.024
	Tool steels (W1-10, M2 etc.)	< 300 HB	-	AH725	ML	260 - 590	0.008 - 0.016
	M	Stainless steels (304, 316 etc.)	< 200 HB	First choice	AH130	ML	330 - 830
< 200 HB			For impact resistance	AH130	MJ	330 - 830	0.008 - 0.024
Stainless steels (420, 430 etc.)		< 200 HB	First choice	AH4035	ML	330 - 1000	0.008 - 0.024
		< 200 HB	For impact resistance	AH4035	MJ	330 - 1000	0.008 - 0.024
K	Gray cast irons (No.25, No.30 etc.)	150 - 250 HB	-	AH725	ML	400 - 830	0.012 - 0.028
	Ductile cast irons (60-40-18 etc.)	150 - 250 HB	-	AH725	ML	330 - 660	0.012 - 0.028
S	Heat-resistant alloys Inconel718, etc.	-	-	AH725	MJ	200 - 530	0.006 - 0.010
	Titanium alloys Ti-6Al-4V, etc.	-	-	AH725	ML	200 - 530	0.006 - 0.010
H	Hardened steels (H13 etc.)	40 - 50 HRC	-	AH725	MJ	200 - 460	0.004 - 0.012
	Hardened steels (D2 etc.)	50 - 60 HRC	-	AH725	MJ	70 - 200	0.002 - 0.008

- Use air blast to remove chips from the work area in slot milling or pocketing operation.
- When machining at high cutting speeds of more than Vc = 3281 sfm, the dynamic balance of the tools must be adjusted.

- Cutting conditions are limited by machine power, workpiece rigidity and spindle output. When the cutting width or depth is large, set Vc and fz to the lower recommended values and check the machine power and vibration.

Tool dia.: ϕD_c (in), Number of revolutions: n (rpm), Feed speed: V_f (ipm), Depth of cut: $a_p = 0.078''$

$\phi 1.000$		$\phi 1.250$			$\phi 1.500$			$\phi 2.000$		$\phi 2.500$		
n	V_f	n	V_f		n	V_f		n	V_f	n	V_f	
			ERP10	ERP12		ERP10/12	ERP16				TRP12	TRP16
2250	90	1790	143	110	1430	120	60	1150	110	910	110	90
$V_c = 590 \text{ sfm}, f_z = 0.020 \text{ ipt}$												
2250	90	1790	143	110	1430	120	60	1150	110	910	110	90
$V_c = 590 \text{ sfm}, f_z = 0.020 \text{ ipt}$												
2140	68	1690	108	80	1350	90	45	1080	85	860	80	70
$V_c = 560 \text{ sfm}, f_z = 0.016 \text{ ipt}$												
2140	51	1690	81	60	1350	90	45	1080	85	860	80	470
$V_c = 560 \text{ sfm}, f_z = 0.012 \text{ ipt}$												
1600	38	1290	62	45	1030	50	25	830	50	660	45	40
$V_c = 420 \text{ sfm}, f_z = 0.016 \text{ ipt}$												
2140	68	1690	108	80	1350	90	45	1080	52	860	80	70
$V_c = 560 \text{ sfm}, f_z = 0.016 \text{ ipt}$												
2140	68	1690	108	80	1350	90	45	1080	52	860	80	70
$V_c = 560 \text{ sfm}, f_z = 0.016 \text{ ipt}$												
2520	81	1990	127	95	1590	110	55	1270	100	1010	95	80
$V_c = 660 \text{ sfm}, f_z = 0.016 \text{ ipt}$												
2520	81	1990	127	95	1590	110	55	1270	100	1010	95	80
$V_c = 660 \text{ sfm}, f_z = 0.016 \text{ ipt}$												
2250	90	1790	143	110	1430	120	60	1150	110	910	110	90
$V_c = 590 \text{ sfm}, f_z = 0.020 \text{ ipt}$												
1910	76	1490	119	90	1190	100	50	950	90	760	90	75
$V_c = 500 \text{ sfm}, f_z = 0.020 \text{ ipt}$												
1340	21	1070	34	25	890	28	14	670	27	530	25	21
$V_c = 350 \text{ sfm}, f_z = 0.008 \text{ ipt}$												
1340	21	1070	34	25	890	28	14	670	27	530	25	21
$V_c = 350 \text{ sfm}, f_z = 0.008 \text{ ipt}$												
1260	20	990	32	25	800	25	15	640	25	510	25	20
$V_c = 330 \text{ sfm}, f_z = 0.008 \text{ ipt}$												
530	5	400	8	6	320	10	5	250	10	200	10	8
$V_c = 140 \text{ sfm}, f_z = 0.005 \text{ ipt}$												

■ Notification for clamping

· When installing the insert, please carefully locate the insert in the seat and fasten the screw.

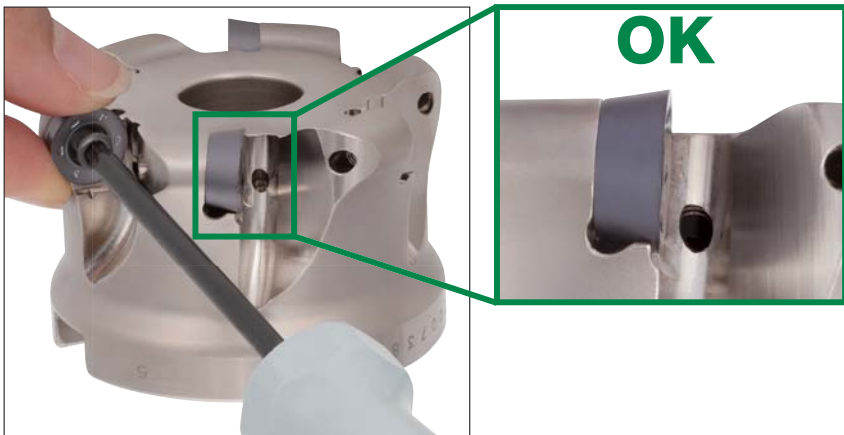
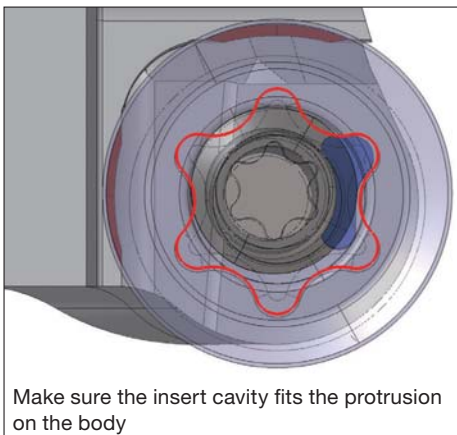

Profile Milling

APPLICATION RANGE

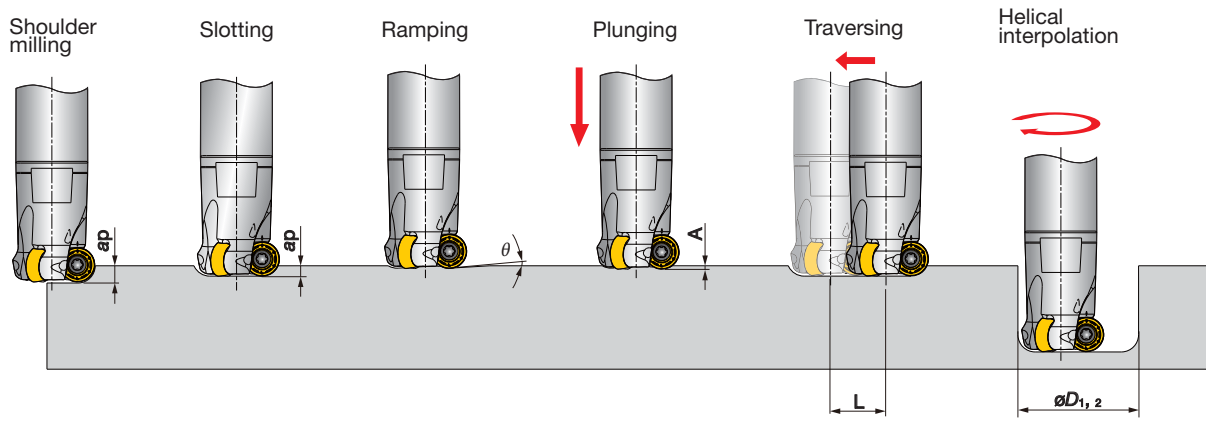

Inch	Tool- ϕ ϕD_c (in)	Max. depth of cut ap (in)	Max. ramping angle θ°	Max. plunging depth A (in)	Machining length for removing uncut portion L (in)	Min. machining ϕD_1 (in)	*Max. machining ϕD_2 (in)
ERP10R100U0100-02	1.000	0.197	3	0.0276	0.630	1.457	1.969
ERP10R125U0125-04	1.250	0.197	8	0.0984	0.866	1.811	2.441
ERP10R150U0125-04	1.500	0.197	6	0.0984	1.142	2.283	2.953
ERP12R125U0125-03	1.250	0.236	8.3	0.0906	0.787	1.693	2.441
ERP12R150U0125-04	1.500	0.236	4	0.0630	1.063	2.244	2.953
ERP16R150U0125-02	1.500	0.315	6	0.0709	0.906	2.008	2.953
TRP12R200U0075A05	2.000	0.236	4	0.0984	1.575	3.189	3.937
TRP12R250U0100A06	2.500	0.236	2.7	0.0906	2.047	4.213	4.921
TRP16R250U0100A05	2.500	0.315	3	0.0906	1.890	3.976	4.921

*For flat bottom hole



Profile Milling

ROUNDSPLIT

TRC12/16

Face mills with button insert of 0.236" (6 mm) or 0.315" (8 mm) radius

A.R. = +0°, R.R. = -1° ~ -5°

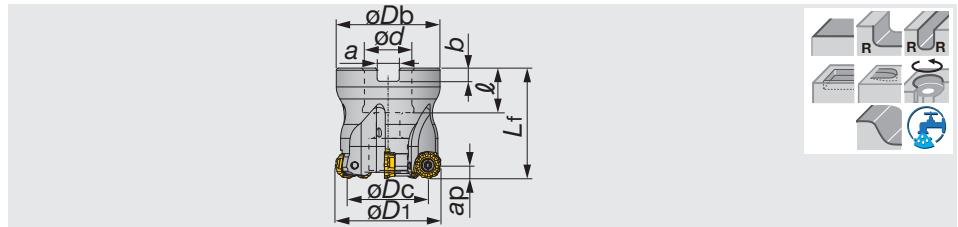

Inch	Max. ap	ϕD_c	z	ϕD_1	ϕD_b	Lf	ϕd	ℓ	a	b	lb	Air hole	Insert
TRC12R200U0075A05	0.236	1.528	5	2.000	1.850	2.000	0.750	0.750	0.320	0.200	0.880	with	RCMT1204...
TRC12R250U0075A06	0.236	2.028	6	2.500	2.320	2.000	0.750	0.750	0.320	0.200	1.540	with	RCMT1204...
TRC12R300U0100A07	0.315	2.528	7	3.000	2.830	2.500	1.000	1.020	0.370	0.240	2.860	with	RCMT1204...
TRC16R200U0075A04	0.315	1.370	4	2.000	1.850	2.000	0.750	0.750	0.320	0.200	0.880	with	RCMT1204...
TRC16R250U0075A05	0.315	1.870	5	2.500	2.320	2.000	0.750	0.750	0.320	0.200	1.540	with	RCMT1204...
TRC16R300U0100A06	0.315	2.370	6	3.000	2.830	2.500	1.000	1.020	0.370	0.240	2.860	with	RCMT1204...
TRC16R400U0150A07	0.315	3.370	7	4.000	3.820	2.500	1.500	1.460	0.620	0.390	3.520	with	RCMT1204...
TRC16R500U0150A08	0.315	4.370	8	5.000	3.780	2.500	1.500	1.460	0.620	0.390	7.930	with	RCMT1204...

SPARE PARTS

Designation	Clamping screw	Grip	Center bolt	Center bolt 1	Torx bit
TRC12R...	CSTB-4L090	H-TBS	-	C0.375X1.125H	BT15S
TRC16R200, 250...	CSTB-5L120	H-TB	-	C0.375X1.125H	BT20S
TRC16R300...	CSTB-5L120	H-TB	-	C0.500X1.375H	BT20M
TRC16R400, 500...	CSTB-5L120	H-TB	TMBA-0.750H	-	BT20M

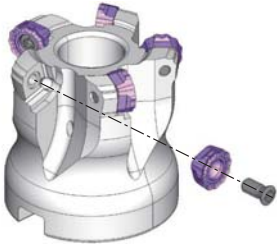

Reference pages

Inserts → **D157**, Standard cutting conditions → **D158**

ROUNDSPLIT

ERC12/16

Indexable endmills with button insert of 0.236" (6 mm) or 0.315" (8 mm) radius

A.R. = +0°, R.R. = -1° ~ -5°

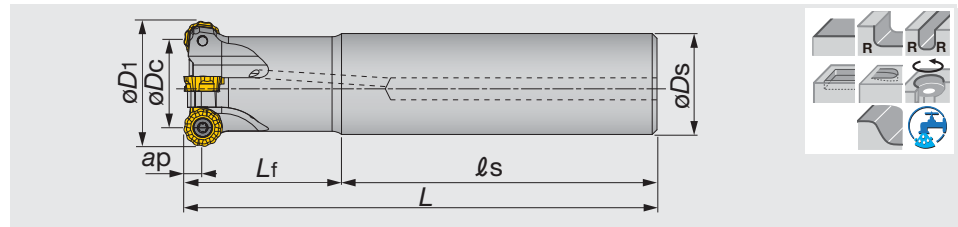

Inch	Max. ap	ϕD_c	z	ϕD_1	ϕD_s	L	L_f	L_s	lb	Air hole	Insert
ERC12R125U0125-03L	0.236	0.778	3	1.25	1.25	6	2.25	3.75	2.05	with	RCMT1204*N-***
ERC12R125U0125-03LL	0.236	0.778	3	1.25	1.25	12	7	5	3.37	with	RCMT1204*N-***
ERC12R125U0125-03LM	0.236	0.778	3	1.25	1.25	8	4	4	2.25	with	RCMT1204*N-***
ERC12R125U0125W03	0.236	0.778	3	1.25	1.25	5	2.75	2.25	1.32	with	RCMT1204*N-***
ERC12R125U150-03LL	0.236	0.778	3	1.25	1.5	12	7	5	4.19	with	RCMT1204*N-***
ERC12R150U0125-04LM	0.236	1.028	4	1.5	1.25	8	4	4	2.36	with	RCMT1204*N-***
ERC12R150U0125-04LX	0.236	1.028	4	1.5	1.25	12	7	5	3.55	with	RCMT1204*N-***
ERC12R150U0125W04	0.236	1.028	4	1.5	1.25	5	2.34	2.66	1.43	with	RCMT1204*N-***
ERC12R150U0150-04L	0.236	1.028	4	1.5	1.5	6	2	3.75	2.42	with	RCMT1204*N-***
ERC12R150U0150-04LM	0.236	1.028	4	1.5	1.5	8	4	4	3.08	with	RCMT1204*N-***
ERC12R150U0150-04LX	0.236	1.028	4	1.5	1.5	12	7	5	4.41	with	RCMT1204*N-***
ERC12R150U0150W04	0.236	1.028	4	1.5	1.5	5	2.34	2.66	1.83	with	RCMT1204*N-***
ERC12R150U150-04LL	0.236	1.028	4	1.5	1.5	12	2	10	5.29	with	RCMT1204*N-***
ERC16R150U0125-02LL	0.315	0.87	2	1.5	1.25	12	2	10	3.81	without	RCMT1606*N-***
ERC16R150U0125-02LM	0.315	0.87	2	1.5	1.25	8	2	6	2.47	with	RCMT1606*N-***
ERC16R150U0125W02	0.315	0.87	2	1.5	1.25	5	2.34	2.66	1.43	with	RCMT1606*N-***
ERC16R150U0150-02L	0.315	0.87	2	1.5	1.5	6	2	4	2.38	with	RCMT1606*N-***
ERC16R150U0150-02LM	0.315	0.87	2	1.5	1.5	8	4	4	3.08	with	RCMT1606*N-***
ERC16R150U0150-02LX	0.315	0.87	2	1.5	1.5	12	7	5	4.62	without	RCMT1606*N-***
ERC16R150U0150W02	0.315	0.87	2	1.5	1.5	5	2.34	2.66	1.83	with	RCMT1606*N-***
ERC16R150U150-02LL	0.315	0.87	2	1.5	1.5	12	2	10	5.29	without	RCMT1606*N-***

SPARE PARTS

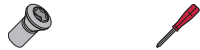

Designation	Clamping screw	Wrench
ERC12R...	CSTB-4L090	T-15DB
ERC16R040...	CSTB-5L105	T-20DB
ERC16R050...	CSTB-5L120	T-20DB

Profile Milling

Reference pages

Inserts → **D157**, Standard cutting conditions → **D158**

INSERT

RCMT-MJ

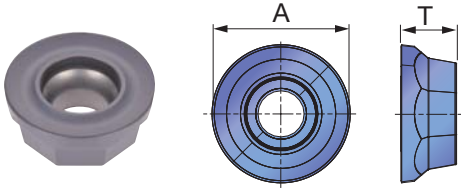

RCMT-NMJ

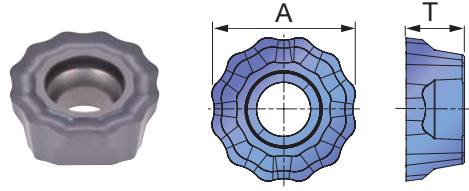

RCMT-NAJ

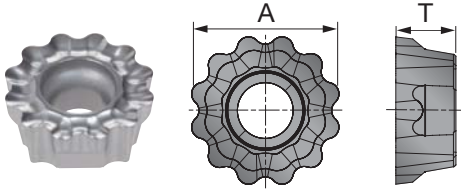

P Steel	☆	★																		
M Stainless		★	☆																	
K Cast iron	★		☆																	
N Non-ferrous							★													
S Superalloys	★		★																	
H Hard materials																				

★ : First choice
☆ : Second choice

Designation	Max. ap	Coated			Un-coated											A	T										
		AH120	AH140	AH725	KS15F																						
RCMT1204EN-NMJ	0.236	●	●	●																			0.472	0.189			
RCMT1204EN-MJ	0.236	●	●	●																					0.472	0.189	
RCMT1204FN-NAJ	0.236				●																				0.472	0.189	
RCMT1606EN-NMJ	0.315	●	●	●																						0.630	0.256
RCMT1606EN-MJ	0.315	●	●	●																						0.630	0.256
RCMT1606FN-NAJ	0.315				●																					0.630	0.256

● : Line up



Profile Milling

STANDARD CUTTING CONDITIONS

ISO	Workpiece material	Hardness HB	Grade	Cutting speed Vc (SFM)	Feed per tooth fz (ipt) each chipbreaker		
					MJ	NMJ	NAJ
P	Low carbon steels (1010, 1015, etc.)	~ 200	AH725	330 - 720	0.008 - 0.028	0.007 - 0.012	-
	High carbon steels (1045, 1055, etc.)	200 ~ 300	AH725	330 - 660	0.008 - 0.028	0.007 - 0.010	-
	Alloyed steels (4140, 5120, etc.)	150 ~ 300	AH725	330 - 660	0.008 - 0.028	0.007 - 0.010	-
	Tool steels (D3, etc.)	~ 300	AH725	330 - 590	0.008 - 0.028	0.007 - 0.010	-
M	Stainless steels (304, 316, etc.)	-	AH140	300 - 590	0.008 - 0.024	0.006 - 0.010	-
K	Grey cast irons (No.250B, etc.)	500 ~ 820	AH120	460 - 820	0.008 - 0.028	0.007 - 0.012	-
	Ductile cast irons (60-40-18, etc.)	500 ~ 820	AH120	460 - 820	0.008 - 0.028	0.007 - .0012	-
N	Aluminum alloys (Si < 13%)	-	KS15F	1640 - 3940	-	-	0.004 - 0.012
	Aluminum alloys (Si ≥ 13%)	-	KS15F	330 - 980	-	-	0.004 - .0012
S	Heat-resisting alloy (Inconel 718, Ti-6Al-4V etc.)	-	AH725	70 - 160	0.008 - 0.024	0.006 - 0.010	-

- To remove excessive chip accumulation use an air blast.
- When chips stick to the cutting edges (aluminum machining), use a water soluble cutting fluid.

- Cutting conditions are limited by machine power and material rigidity. When the cutting width or depth is large, set Vc and fz below the recommended values and check the machine vibration and spindle load.



Profile Milling

Holemaking with helical feed

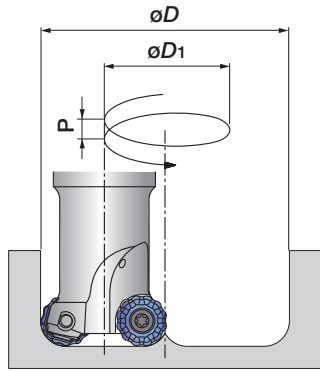

Designation	Tool ϕ ϕD_c (in)	Min. machining diameter (in)		Max. machining diameter (in)		Pitch P (in)
		ϕD	ϕD_1	ϕD	ϕD_1	
ERC12R125U...	1.250	2.028	0.778	2.421	1.171	< 0.236
ERC12R150U...	1.500	2.528	1.028	2.921	1.421	< 0.236
TRC12R200U...	2.000	3.528	1.528	3.921	1.921	< 0.236
TRC12R250U...	2.500	4.528	2.028	4.921	2.421	< 0.236
TRC12R300U...	3.000	5.528	2.528	5.921	2.921	< 0.236
ERC16R150U...	1.500	2.370	0.870	2.921	1.421	< 0.315
TRC16R200U...	2.000	3.370	1.370	3.921	1.921	< 0.315
TRC16R250U...	2.500	4.370	1.870	4.921	2.421	< 0.315
TRC16R300U...	3.000	5.370	2.370	5.921	2.921	< 0.315
TRC16R400U...	4.000	7.370	3.370	7.921	3.921	< 0.315
TRC16R500U...	5.000	9.370	4.370	9.921	4.921	< 0.315

When holemaking with a helical feed, the pitch (P) needs to be set at lower values than that shown above.

Ramping

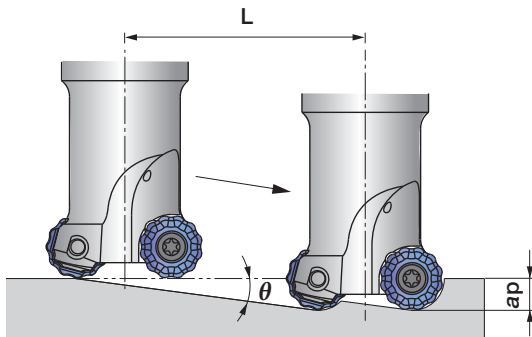

Designation	Tool ϕ ϕD_c (in)	Max. ramping angle θ°	L: tool pass length when ramping angle is 2 degrees				
			ap (in)				
			0.079	0.118	0.158	0.236	0.315
ERC12R125U...	1.250	10	2.244	3.346	4.488	6.732	-
ERC12R150U...	1.500	7	2.244	3.346	4.488	6.732	-
TRC12R200U...	2.000	5.5	2.244	3.346	4.488	6.732	-
TRC12R250U...	2.500	3.5	2.244	3.346	4.488	6.732	-
TRC12R300U...	3.000	2.5	2.244	3.346	4.488	6.732	-
ERC16R150U...	1.500	16	2.244	3.346	4.488	6.732	-
TRC16R200U...	2.000	9.5	2.244	3.346	4.488	6.732	9.016
TRC16R250U...	2.500	6.5	2.244	3.346	4.488	6.732	9.016
TRC16R300U...	3.000	4.5	2.244	3.346	4.488	6.732	9.016
TRC16R400U...	4.000	3	2.244	3.346	4.488	6.732	9.016
TRC16R500U...	5.000	2.5	2.244	3.346	4.488	6.732	9.016

Tool pass length: $L = ap / \tan \theta$, Ramping angle needs to be set at smaller than 2 degrees in order to prevent chips from getting tangled.

TRD12/16

Face mills with button insert of 0.236" (6 mm) or 0.315" (8 mm) radius

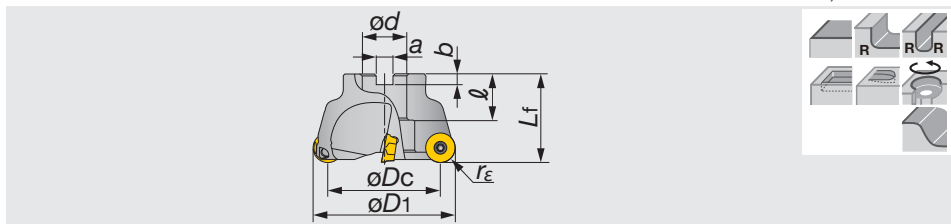

Inch	Max. ap	ϕD_c	z	ϕD_1	L_f	ϕd	ℓ	a	b	r_ϵ	lb	Insert
TRD12050RU	0.236	1.528	4	2.00	1.560	0.750	1.570	0.315	0.197	0.236	0.990	RDM*1204...
TRD16080RU	0.315	2.520	4	3.15	2.000	1.000	1.970	0.375	0.236	0.315	1.600	RDM*1606...
TRD16100RU	0.315	3.310	5	3.94	2.000	1.250	1.970	0.500	0.315	0.315	2.200	RDM*1606...
TRD16125RU	0.315	4.290	6	4.92	2.500	1.500	2.480	0.625	0.394	0.315	5.300	RDM*1606...

SPARE PARTS

Designation	Clamp screw	Wrench
TRD12...	CSTB-3.5	T-15D
TRD16...	CSTB-5	T-20D

Reference pages

Inserts → D160, Standard cutting conditions → D161

ERD12

Indexable endmills with button insert of 0.236" (6 mm) or 0.315" (8 mm) radius

A.R. = +8°~ 10°, R.R. = -6°~ -2°

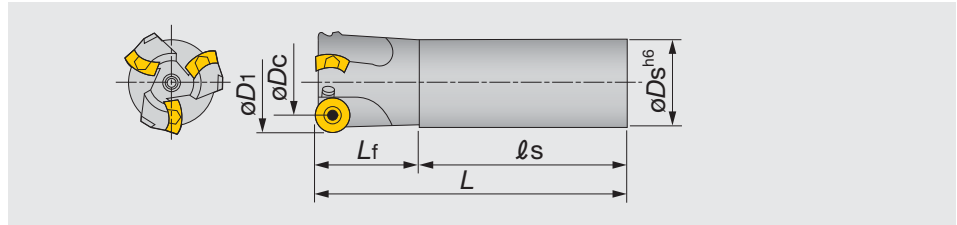

Inch	Max. ap	ϕD_c	z	ϕD_1	ϕD_s	L	L _f	ℓ _s	Insert
ERD12125RSU	0.236	0.778	2	1.250	1.250	4.780	1.970	2.280	RDM*1204...
ERD12150RSU	0.236	1.028	3	1.500	1.500	4.780	1.970	2.280	RDM*1204...
ERD12200RSU	0.236	1.528	4	2.000	2.000	4.780	1.970	2.280	RDM*1204...
ERD12125RLU	0.236	1.250	2	1.250	1.250	10.000	1.970	7.500	RDM*1204...
ERD12150RLU	0.236	1.500	3	1.500	1.500	10.000	1.970	7.500	RDM*1204...
ERD12200RLU	0.236	2.000	4	2.000	2.000	10.000	1.970	7.500	RDM*1204...

SPARE PARTS

Designation	Clamp screw	Lubricant	Wrench
ERD12**R...	CSTB-3.5	M-1000	T-15D

INSERT

RDMT12/16-MJ

Button insert with pressed MJ chipbreaker

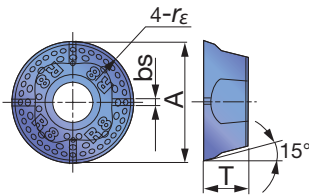

RDMW12/16

Flat-top button insert with 0.236" (6 mm) or 0.315" (8 mm) radius

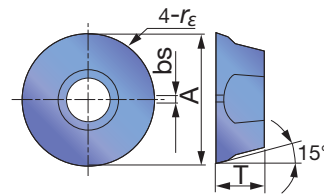

P Steel	☆			★	★		☆												
M Stainless		★	☆																
K Cast iron	★																		
N Non-ferrous																			
S Superalloys	★	☆																	
H Hard materials																			

★ : First choice
☆ : Second choice

Designation	r _ε	Max. ap	Coated					Un-coated	A	T	bs
			AH120	AH130	AH140	AH330	T3130	UX30			
RDMT1204ZDPN-MJ	0.236	0.236	●	●		●	●		0.504	0.187	0.031
RDMW1204ZDSN	0.236	0.236	●						0.504	0.187	0.031
RDMT1606ZDPN-MJ	0.315	0.315	●	●	●	●	●		0.661	0.250	0.031
RDMW1606ZDSN	0.315	0.315	●						0.661	0.250	0.031

● : Line up

Profile Milling

Reference pages

Standard cutting conditions → D161

STANDARD CUTTING CONDITIONS

ISO	Workpiece material	Grade	Cutting speed Vc (sfm)	Feed per tooth: fz (ipt)	
				T/ERD12	T/ERD16
P	Carbon steels (1018, 1055) < 300 HB	AH120	390 ~ 720	0.012 ~ 0.020	0.012 ~ 0.024
		AH330	460 ~ 790	0.008 ~ 0.016	0.008 ~ 0.020
		UX30	260 ~ 390	0.008 ~ 0.016	0.008 ~ 0.020
	Alloy steels (4140, 4340) < 300 HB	AH120	330 ~ 660	0.008 ~ 0.018	0.008 ~ 0.020
		AH330	390 ~ 720	0.006 ~ 0.014	0.006 ~ 0.016
		UX30	200 ~ 390	0.006 ~ 0.014	0.006 ~ 0.016
Die steels (H13, P20 etc.) < 300 HB	AH120	260 ~ 590	0.008 ~ 0.014	0.010 ~ 0.018	
	AH330	330 ~ 660	0.004 ~ 0.012	0.004 ~ 0.016	
M	Stainless steels (JIS SUS304 etc.)	AH130-AH140	330 ~ 660	0.008 ~ 0.012	0.008 ~ 0.016
K	Grey Cast irons (JIS CLASS 25-40)	AH120	390 ~ 790	0.012 ~ 0.020	0.012 ~ 0.024
		AH330	490 ~ 820	0.008 ~ 0.016	0.008 ~ 0.020
H	Hard materials < A980	AH120	200 ~ 460	0.003 ~ 0.010	0.004 ~ 0.012

Note: When the depth of cut is smaller than 0.078", use the higher limit of feed values shown above. When larger than 0.118", use the lower limit of the feed values.

Plunging + traverse feed milling (Unit: in)

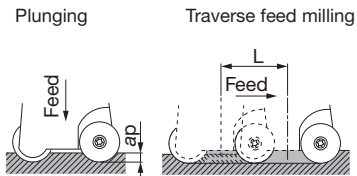

Ramping

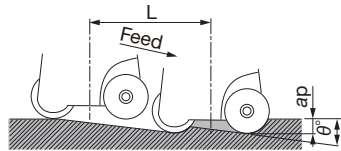

Helical feed drilling

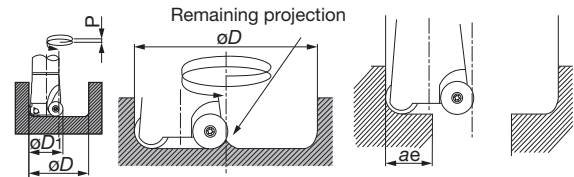

Inch	$\phi D1$	Max. plunging depth ap	Max. ramping angle θ°	Min. traverse length to flatten the bottom surface L	Min. machining diameter ϕD	Max. machining diameter ϕD	Pitch P	$\phi Dc-ra$ ae
TRD1205RU	2.00	0.157	8	1.567	3.47	3.86	< 0.236	0.157
TRD16080RU	3.15	0.216	4	2.559	5.67	6.22	< 0.315	0.216
TRD16100RU	3.94	0.216	3	3.349	7.24	7.80	< 0.315	0.216
TRD16125RU	4.92	0.216	2	4.329	9.21	9.76	< 0.315	0.216
ERD12125RSU/RLU	1.25	0.157	16	0.817	2.05	2.44	< 0.236	0.157
ERD12150RSU/RLU	1.50	0.157	8	1.067	2.68	3.07	< 0.236	0.157
ERD12200RSU/RLU	2.00	0.157	6	1.567	3.47	3.86	< 0.236	0.157

$\phi D1$: Tool diameter

ϕD : Drilling diameter

P : Z-axis feed per one round of tool pass (Pitch of helical cycle)

- Notes:
- In plunging, the maximum plunging depth is limited as shown in the above table.
 - In plunging, set the Z-axis feed in a range of 0.0019 to 0.0039 ipt.
 - When plunging, use peck-feed every 0.039" (or smaller than 0.039") to break chips.
 - $\tan\theta$ = depth of cut: ap / length of tool pass: L
 - In ramping, the ramping angle should be set within the maximum ramping angle.
 - In helical feed hole machining, the machinable hole diameters are limited by the tool diameter as shown in the above tables.
 - When machining between the minimum and maximum machining diameters, a projection remains in the center of the bottom surface of the hole as shown in the Figure at right. Remove it by traverse feed milling.



Profile Milling

EWD05/07/10

Indexable endmills with bottom inserts of 0.098", 0.138", and 0.196" (2.5, 3.5, and 5 mm) radius

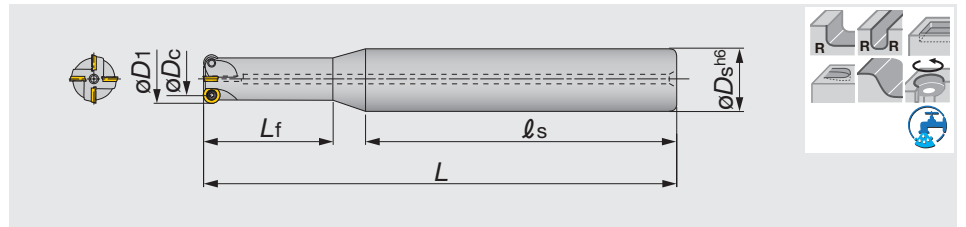

Inch	Max. ap	ϕD_c	z	ϕD_1	ϕD_s	l_s	L_f	L	Air hole	Insert
EWD05050RU	0.098	0.304	2	0.500	0.750	3.250	0.750	5.000	with	RDMW0501M0
EWD05075RU	0.098	0.554	3	0.750	1.000	5.000	1.500	7.000	with	RDMW0501M0
EWD07075RU	0.138	0.475	4	0.750	1.000	5.000	1.500	7.000	with	RDMW0702M0
EWD07100RU	0.138	0.725	5	1.000	1.250	5.250	1.750	8.000	with	RDMW0702M0
EWD07125RU	0.138	0.975	3	1.250	1.500	5.500	1.750	9.000	with	RDMW0702M0
EWD10100RU	0.196	0.606	3	1.000	1.250	5.250	1.750	8.000	with	RDMW1003M0
EWD10125RU	0.196	0.856	5	1.250	1.500	5.500	1.750	9.000	with	RDMW1003M0

SPARE PARTS

Designation	Clamping screw	Wrench
EWD05050RU	CSTD-1.8	T-6D
EWD05075RU	CSTD-1.8	T-6D
EWD07075RU	CSTB-2.5S	T-8D
EWD07100RU	CSTB-2.5S	T-8D
EWD07125RU	CSTB-2.5S	T-8D
EWD10100RU	CSTB-3.5H	T-15D
EWD10125RU	CSTB-3.5H	T-15D

HWD07-M

Indexable endmills with TungFlex, carrying bottom inserts of 3.5 mm radius

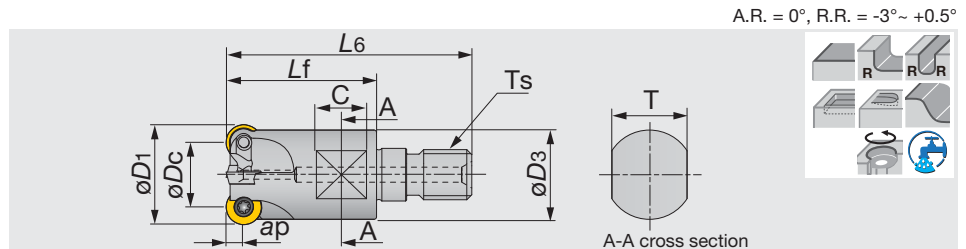

Metric	Max. ap	ϕD_c	z	ϕD_1	L_6	L_f	C	T	ϕD_3	T_s	Kg	Air hole
HWD07R015MM08-03	3.5	8	3	15	42	25	8	10	12.8	M8	0.03	with
HWD07R020MM10-04	3.5	13	4	20	49	30	10	15	17.8	M10	0.06	with
HWD07R025MM12-05	3.5	18	5	25	57	35	10	17	20.8	M12	0.1	with
HWD07R030MM16-05	3.5	23	5	30	63	40	12	22	28.8	M16	0.2	with

See page D147 for TungFlex modular shank.

SPARE PARTS

Designation	Clamping screw	Lubricant	Wrench
HWD07-M...	CSTB-2.5S	M-1000	T-8D

Reference pages

Inserts, Standard cutting conditions → D163

INSERT

RDMW05/07/10

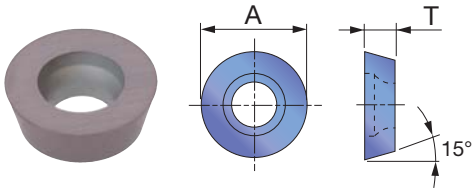

P	Steel	★
M	Stainless	
K	Cast iron	★
N	Non-ferrous	
S	Superalloys	★
H	Hard materials	

★ : First choice
☆ : Second choice

Designation	Max. ap	Coated						A	T
		AH120							
RDMW0501M0	0.098	●						0.197	0.055
RDMW0702M0	0.138	●						0.276	0.094
RDMW1003M0	0.196	●						0.394	3.180

● : Line up

STANDARD CUTTING CONDITIONS

ISO	Workpiece material	Grade	Cutting speed Vc (sfm)	Feed per tooth fz (ipt)	Depth of cut ap (in)		
					Cutter dia. ø10, 12	Cutter dia. ø15, 20	Cutter dia. ø25
P	Carbon steels (1018, 1055) < 300 HB	AH120	650 - 1640	0.006 - 0.018	- 0.020	- 0.028	- 0.039
	Alloy steels (4140, 4340) < 300 HB	AH120	390 - 1150	0.006 - 0.014	- 0.020	- 0.028	- 0.039
	Die steels (H13, P20 etc.) < 300 HB	AH120	330 - 980	0.004 - 0.012	- 0.020	- 0.028	- 0.039
K	Cast irons (JIS CLASS 25-40)	AH120	660 - 1640	0.008 - 0.020	- 0.020	- 0.028	- 0.039
H	Hardened steels, Prehardened steels < 40HRC	AH120	230 - 660	0.004 - 0.010	- 0.020	- 0.028	- 0.039

APPLICATION RANGE (HWD07-M)

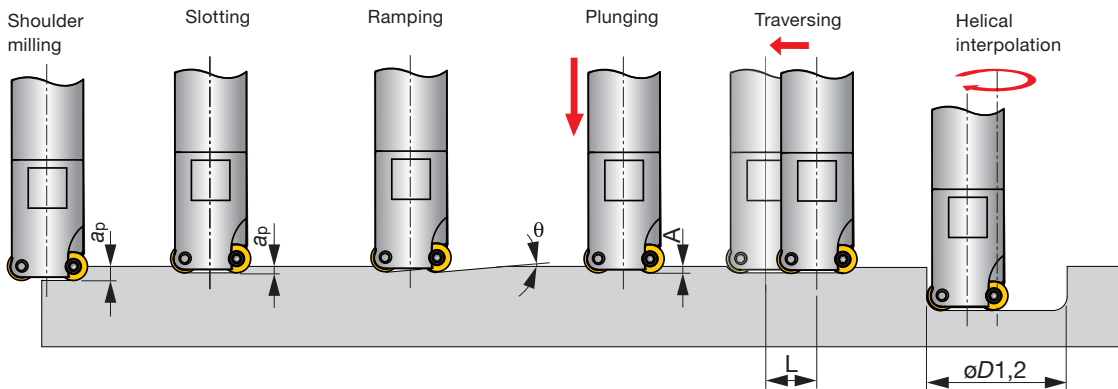

Tool-ø		Max. depth of cut	Max. ramping	Max. plunging depth	Machining length for removing uncut portion	Max. machining	*Max. machining
Inch	øDc (mm)	ap	θ°	A	L	øD1	øD2
HWD07R015MM08-03	15	0.138	25	0.079	øDc - 0.236	0.906	1.102
HWD07R020MM10-04	20	0.138	11	0.079	øDc - 0.236	1.299	1.496
HWD07R025MM12-05	25	0.138	7	0.079	øDc - 0.236	1.693	1.890
HWD07R030MM16-05	30	0.138	5.5	0.079	øDc - 0.236	2.087	2.283

*For flat bottom hole



Profile Milling

EBP

Indexable ball-nose endmill for semi-finishing

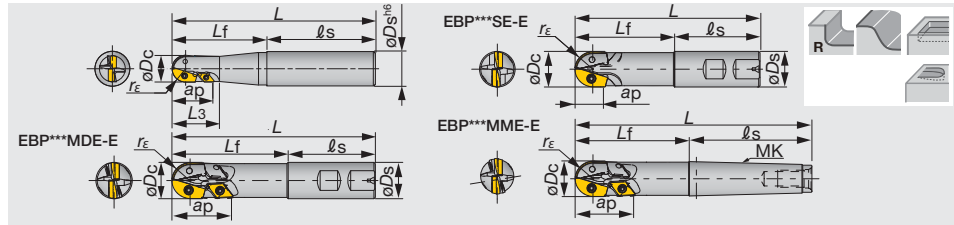

Inch	Max. ap	øDc	z	øDs	ls	Lf	L	L3	rε	MK	Insert 1	Insert 2
EBP075MWU	0.625	0.750	2	1.000	2.280	2.750	5.030	1.250	0.375	-	ZPET075MJ	-
EBP100MWU	0.827	1.000	2	1.000	2.280	3.250	5.530	-	0.500	-	ZPET100MJ	-
EBP125MWU	1.000	1.250	2	1.250	2.280	3.750	6.030	-	0.625	-	ZPET125MJ	-
EBP075LWEU	1.140	0.750	2+2	1.000	2.280	3.750	6.030	1.250	0.375	MK2	ZPET075MJ	DCMW070204TN
EBP100LWEU	1.610	1.000	2+2	1.000	2.280	4.250	6.530	-	0.500	-	ZPET100MJ	DCMW11T304TN
EBP125LWEU	1.810	1.250	2+2	1.250	2.280	4.750	7.030	-	0.625	-	ZPET125MJ	DCMW11T304TN

SPARE PARTS

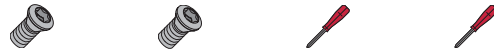

Designation	Clamping screw for Insert 1	Clamping screw for Insert 2	Wrench for Insert 1	Wrench 1 for Insert 1
EBP075MWU	CSTD-3T	-	T-10D	-
EBP100MWU	CSTB-4S	-	T-15D	-
EBP125MWU	CSTB-5S	-	T-20D	-
EBP075LWEU	CSTD-3T	CSTB-2.5S	T-10D	T-8D
EBP100LWEU	CSTB-4S	CSTB-4S	T-15D	T-15D
EBP125LWEU	CSTB-5S	CSTB-4S	T-20D	T-15D

INSERT

ZPET-MJ (for Radius)

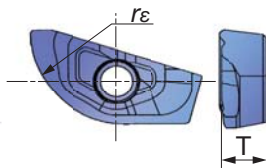

DCMW-TN (for Peripheral)

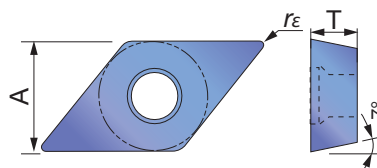

P	Steel	☆	★									
M	Stainless											
K	Cast iron	★										
N	Non-ferrous											
S	Superalloys											
H	Hard materials	☆										

★ : First choice
☆ : Second choice

Designation	rε	Coated										A	T	
		AH120	AH330											
ZPET075-MJ	0.375	●	●										-	0.177
ZPET100-MJ	0.500	●	●										-	0.182
ZPET125-MJ	0.625	●	●										-	0.266
DCMW070204TN	0.016	●	●										0.252	0.266
DCMW11T304TN	0.016	●	●										0.375	0.094

● : Line up

Reference pages

Standard cutting conditions → **D165**

STANDARD CUTTING CONDITIONS

EBP

ISO	Workpiece material	Grade	Machining type	Cutting speed Vc (sfm)	Table feed vf (in/min)		
					Tool dia. : ø0.750	Tool dia. : ø25	Tool dia. : ø30
P	Carbon steels (1055 etc.) < 300 HB	AH120	(1)	550 - 750	24 - 30	18 - 30	14 - 26
		AH120	(2)	650 - 850	35 - 51	27 - 43	21 - 37
		AH120	(3)	500 - 650	14 - 23	12 - 24	9 - 21
	Alloy steels (4140, 4340) < 300 HB	AH120	(1)	500 - 690	21 - 33	16 - 28	12 - 24
		AH120	(2)	590 - 780	32 - 47	16 - 32	19 - 34
		AH120	(3)	425 - 590	14 - 26	10 - 22	8 - 19
	Die steels (JIS SKD11 etc.) < 300 HB	AH330	(1)	400 - 590	17 - 28	12 - 24	9 - 21
		AH330	(2)	500 - 690	26 - 42	19 - 35	15 - 30
		AH330	(3)	330 - 500	10 - 22	7 - 19	5 - 17
K	Cast irons (JIS CLASS 25-40)	AH120	(1)	550 - 750	32 - 43	24 - 36	19 - 31
		AH120	(2)	650 - 850	35 - 55	28 - 47	21 - 41
		AH120	(3)	500 - 650	17 - 28	12 - 24	9 - 21
H	Hardened steels Prehardened steels < A980	AH120	(1)	200 - 330	6 - 14	4 - 12	4 - 10
		AH120	(2)	230 - 425	6 - 18	4 ~16	4 - 14
		AH120	(3)	130 - 260	6 - 10	4 - 8	3 - 7

Notes:

- Cutting speeds shown in the left table are of the most outer diameter of the tool.
- The values of the cutting speeds and feeds shown in the table are of under general cutting conditions. The values should be modified depending on the power and rigidity of the machine to be used, and work holding conditions.
- When using the long shank type, the depth of cut, pick feed, cutting speed, and table feed should be reduced to 70 %-90 % of the values shown in the tables.

EBD

ISO	Workpiece material	Grade	Machining type	Cutting speed Vc (sfm)	Table feed vf (in/min)	
					Tool dia.: ø1.57	Tool dia.: ø2.00
P	Carbon steels (1055 etc.) < 300 HB	AH120	(1)	500 - 690	16 - 22	3 - 18
		AH120	(2)	550 - 750	16 - 22	13 - 17
		AH120	(3)	425 - 625	8 - 12	6 - 10
	Alloy steels (4140, 4340) < 300 HB	AH120	(1)	425 - 625	14 - 20	11 - 16
		AH120	(2)	500 - 690	14 - 20	11 - 16
		AH120	(3)	360 - 560	7 - 11	5 - 9
	Die steels (H13,P20 etc.) < 300 HB	AH120	(1)	360 - 560	12 - 18	10 - 15
		AH120	(2)	425 - 625	12 - 18	10 - 14
		AH120	(3)	295 - 500	6 - 10	5 - 8
K	Cast irons (JIS CLASS 25-40)	AH120	(1)	550 - 750	20 - 27	16 - 21
		AH120	(2)	625 - 820	20 - 27	16 - 21
		AH120	(3)	500 - 690	12 - 20	9 - 13
H	Hardened steels Prehardened steels < A980	AH120	(1)	230 - 360	6 - 10	5 - 8
		AH120	(2)	260 - 400	6 - 10	5 - 8
		AH120	(3)	160 - 300	3 - 6	2 - 5

Notes:

- Cutting speeds shown in the left table are of the most outer diameter of the tool.
- The values of the cutting speeds and feeds shown in the table are of under general cutting conditions. The values should be modified depending on the power and rigidity of the machine to be used, and work holding conditions.
- When using the long shank type, the depth of cut, pick feed, cutting speed, and table feed should be reduced to 70 %-90 % of the values shown in the tables.

Machining types

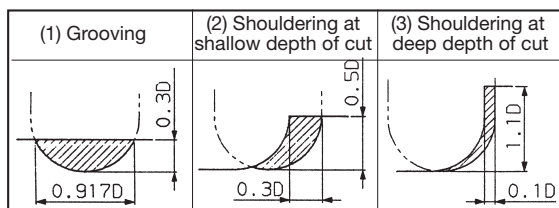

EBD

Indexable ball-nose endmill for roughing

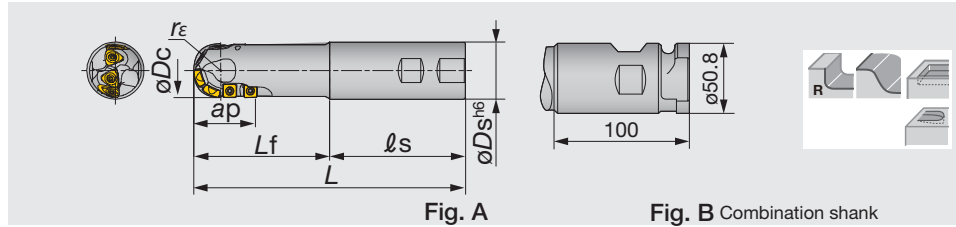

Metric	Max. a_p	ϕD_c	z	ϕD_s	ℓ_s	L_f	L	r_{ϵ}	Fig.	Insert for R	Insert for P
EBD040SSE	45	40	4 (7)	42	100	100	200	20	A	ZDMT4005-MJ	SCMT09T308-23
EBD040MSE	45	40	4 (7)	42	100	150	250	20	A	ZDMT4005-MJ	SCMT09T308-23
EBD050SSE	59	50	4 (7)	42	100	100	200	25	A	ZDMT5006-MJ	SCMT120408-23
EBD050MSE	59	50	4 (7)	42	100	150	250	25	A	ZDMT5006-MJ	SCMT120408-23
EBD050SCE	59	50	4 (7)	50.8	100	100	200	25	B	ZDMT5006-MJ	SCMT120408-23
EBD050MCE	59	50	4 (7)	50.8	100	150	250	25	B	ZDMT5006-MJ	SCMT120408-23

SPARE PARTS

Designation	Clamping screw	Lubricant	Wrench
EBD040*SE	CSTB-4M	M-1000	T-15T
EBD050**E	CSTB-5	M-1000	T-20T

INSERT

ZDMT-MJ (For R-edge)

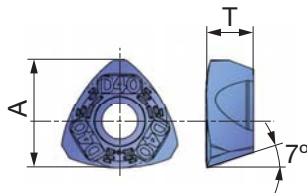

SCMT-23 (For peripheral edge)

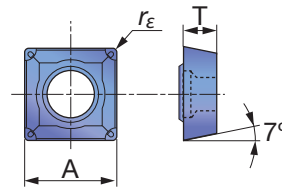

P	Steel	☆	
M	Stainless		
K	Cast iron	★	
N	Non-ferrous		
S	Superalloys		
H	Hard materials	☆	

★ : First choice
☆ : Second choice

Designation	r_{ϵ}	Coated								A	T
		AH120									
ZDMT4005-MJ	-	●								0.512	0.217
ZDMT5006-MJ	-	●								0.638	0.256
SCMT09T308-23	0.031	●								0.375	0.156
SCMT120408-23	0.031	●								0.500	0.187

● : Line up

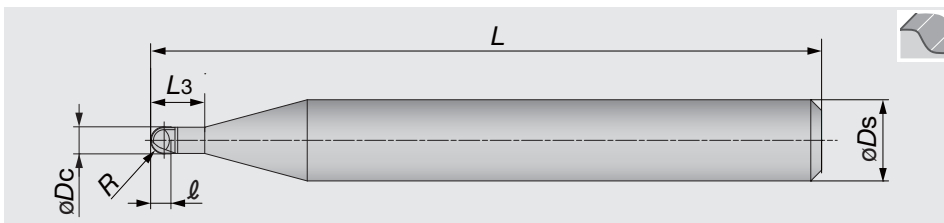

Metric	BX850	z	R	øD _c	l	L ₃	L	øD _s
BBB2006	●	2	0.3	0.6	0.5	1.2	50	6
BBB2008	●	2	0.4	0.8	0.6	1.6	50	6
BBB2010	●	2	0.5	1	0.7	2	50	6
BBB2020	●	2	1	2	1.5	4	50	6

●: Line up

Tolerance (BBB2000)

R	R Tolerance	Tolerance on shank
0.3 - 1.0	±0.005	h6

STANDARD CUTTING CONDITIONS

ISO	Workpiece material	Hardness	No. of revolutions n (min ⁻¹)	Ball radius (R)							
				0.3		0.4		0.5		1	
				Depth of cut ap × pf (mm)	Feed rate (mm/min)	Depth of cut ap × pf (mm)	Feed rate (mm/min)	Depth of cut ap × pf (mm)	Feed rate (mm/min)	Depth of cut ap × pf (mm)	Feed rate (mm/min)
H	Prehardened steels (NAK80, etc.) Die steels (JIS SKD61, etc.)	~ 52 HRC	50,000	0.02 × 0.03	2,000	0.03 × 0.05	2,000	0.05 × 0.05	3,000	0.10 × 0.10	5,000
	Die steels (JIS SKD11, DRM1 & 2, etc.)	~ 62 HRC	50,000	0.01 × 0.02	2,000	0.02 × 0.03	2,000	0.03 × 0.05	3,000	0.05 × 0.05	5,000
	High speed steel and die steel (JIS SKH, DRM3, etc.)	~ 70 HRC	50,000	0.01 × 0.02	1,500	0.01 × 0.03	1,500	0.02 × 0.03	2,000	0.03 × 0.05	3,000

Notes:

- Depths of cut (ap) shown in the table are the allowable maximum values.
- Mist cooling or air blow is recommended.
- The maximum number of revolutions of the machine to be used is lower than 50,000 min⁻¹, the revolutions and feed rate should be modified at same rate.
- Use smallest possible overhang.

Ball radius (R)	Inclined angle of workpiece (θ1) / Effective neck length (Z)			
0.3	0°30'/1.25	1°/1.30	2°/1.35	3°/1.45
0.4	0°30'/1.65	1°/1.70	2°/1.80	3°/1.90
0.5	0°30'/2.05	1°/2.10	2°/2.25	3°/2.40
1	0°30'/4.15	1°/4.25	2°/4.50	3°/4.80



Profile Milling

MillLine - Multi-Functional Milling

				Inch	Metric
	TUNGMEISTER Endmills with exchangeable heads for reduced tool change time $\phi 0.236'' - \phi 0.984''$ ($\phi 6 \text{ mm} - \phi 25 \text{ mm}$)		D170 P M K N S H	<input checked="" type="checkbox"/>	<input checked="" type="checkbox"/>
	HYBRIDTACMILL Multi-functional endmills $\phi 0.393'' - \phi 0.629''$ max. ap 0.314"		D200 P M K N	<input checked="" type="checkbox"/>	<input type="checkbox"/>
	EVX Multi-functional endmills in larger diameters $\phi 0.629'' - \phi 2.480''$ ($\phi 16 \text{ mm} - \phi 63 \text{ mm}$) max. ap 0.59" ($\phi 15 \text{ mm}$)		D203 P M K	<input checked="" type="checkbox"/>	<input checked="" type="checkbox"/>
	ECC Chamfering endmills for large lengths $\phi 1.338'' - \phi 2.165''$ ($\phi 34 \text{ mm} - \phi 55 \text{ mm}$)		D206 P M K	<input checked="" type="checkbox"/>	<input checked="" type="checkbox"/>
	ECP Chamfering endmills for small lengths $\phi 0.394'' - 1.417''$ ($10 \text{ mm} - \phi 36 \text{ mm}$)		D208 P K	<input checked="" type="checkbox"/>	<input checked="" type="checkbox"/>
	TCB Counter boring tool for flat bottom finish $\phi 14 \text{ mm} - \phi 43 \text{ mm}$		D209 P M K	<input type="checkbox"/>	<input checked="" type="checkbox"/>
	Thread Milling Threading tool with a single indexable insert M28 - M90		D211 P M	<input type="checkbox"/>	<input checked="" type="checkbox"/>



TungMeister

Tungaloy D169



TUNGMEISTER Features

The most effective tooling solution with the option of hundreds of tools!

Tool changeover times can be measurably reduced!

► Reduces tool changeover times drastically!!

- Machine downtime is decreased considerably.
- Enables users to only change cutting head, simplifying set-ups

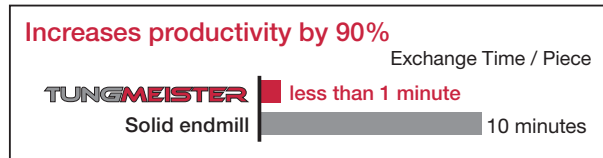

► Highly accurate repeatability

- Accuracy can be maintained by touching the taper and face.

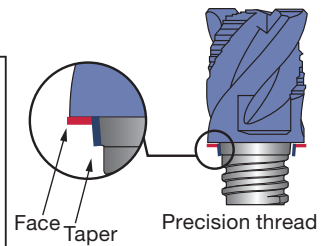
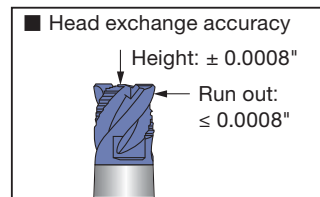

► The weight of the tool to be disposed is reduced

- Reduces tool disposal

For example: $\varnothing 0.50"$ / square endmill

TUNGMEISTER : OAL 0.80" \rightarrow weight 20 g
conventional solid endmill : OAL 3.00" \rightarrow weight 140 g

► No regrinding cost

- No laborious endmill regrinding required.

1 Wide range of cutting heads

23 kinds of cutting heads are available. The head exchange is easy and highly accurate with the precision thread.

Flexible combinations
TungMeister can be applied to all kinds of endmill machining applications.

2 Three kinds of shank material

Users can choose the most suitable combination according to the machining parameters, length and rigidity required.



- Steel: For general purpose
- Carbide: For highly accurate machining with excellent rigidity
- Tungsten: Reduced chattering due to vibration dampening capacity



Straight shank & neck



Straight shank & neck (carbide)



Straight shank & taper neck



Straight (for grooving)



Overview

Head

Head	Square	Ball	Torodial	High Feed	Drilling (Centering drill)	Chamfering	Slotting
Appearance							
Page	D173	D182	D178	D181	D185	D188	D190

Shank

Shank	Straight	Weldon	Straight	Straight (Slotting)
Neck	Straight	Straight	Taper	
Appearance				
Steel	●	●	●	●
Carbide	●	-	●	●
Tungsten (with oil hole)	●	-	●	-
Page	D194	D194	D196	D197

Cutting performance

Work material: 304SS (200HB) Head: VEE037L27R031-U04S06 (ø.375", square type, 4 flutes, Grade: AH725)	Shank: VSS037L300S06US (Straight shank & neck, steel)	Machine: Horizontal CAT40 Holder: Collet chuck Cutting fluids: Dry
---	--	--

Comparison of milling for stainless steels

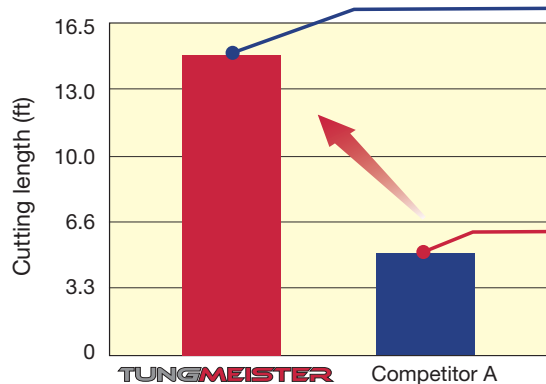

Cutting speed : $V_c = 330$ sfm
 Feed rate : $f_z = 0.003$ ipt
 Depth of cut : $a_p = 0.20$ "
 Cutting width : $a_e = 0.060$ "

- Competitor A cutting edges fractured after 1.7 minutes of machining and a 38" cutting length.
- The TungMeister cutting edges are still able to cut after 5 minutes of machining.

Comparison of milling surface on stainless steels



Cutting speed : $V_c = 430$ sfm
 Feed rate : $f_z = 0.002$ ipt
 Depth of cut : $a_p = 0.20$ "
 Cutting width : $a_e = 0.080$ "

- When machining tough stainless steel the burr created by the TungMeister is minimal. However, competitor A has a large burr when working under the same conditions.



Designation system

Shank

V **SS** **D10** **L070** **S** **06** - **W** - **A**

1 2 3 4 5 6 7 8

1 Series	
V	TungMeister

2 Shank type	
SS	Straight neck
TS	Taper neck
SC	Slotting
ST	for T-Slotting
AD	TungFlex adapter

3 Shank diameter (mm)	
D08	ø8
D10	ø10
D12	ø12
D16	ø16
D20	ø20
D25	ø25
D32	ø32
VSC, VAD type	
100	ø10
120	ø12
130	ø13
180	ø18
210	ø21

4 Length (mm)	
L070	70

5 Shape of shank	
S	Cylindrical
W	Weldon

6 Connection screw size	
05	S05
06	S06
08	S08
10	S10
12	S12
15	S15

7 Shank material	
S	Steel
C	Carbide
W	Tungsten

8 Additional feature	
A	with coolant hole
M	Thread size (TungFlex adapters)

Head

● Square endmill

V **E** **E** **080** **L05.0** **R00** - **03** **S05**

1 2 3 4 5 6 7 8 9

● Ball nose endmill

V **B** **D** **200** **L15.0** - **BG** - **04** **S12**

1 2 3 4 5 6 7 8 9

1 Series	
V	TungMeister

2 Cutting edge	
E	Square
B	Ball
R	Radius
FX	for high feed
CA	for chamfering
CP	Spot drilling
CW	for chamfering (front and back)
CR	for R chamfering
GC	for counter boring
DP	for center drilling
S	for slotting
T	for T-slot milling

3 Helix angle / Rake face	
B	0°
C	15°
D	30°
E	38° - 50°
F	60°
T	Land

4 Diameter (mm)	
060	ø6
200	ø20

5 Cutting edge length (mm)	
Length	
L07.0	7
L15.0	15
Groove width	
W1.50	1.5
W1.57	1.57
W10.0	10

6 Corner shape / Angle	
Nose radius	
R00	Sharp edge
R005	R0.05
R01	R0.1
R05	R0.5
R10	R1.0
Chamfer type	
C15	0.15 x 45°
C30	0.3 x 45°
C60	0.6 x 45°
Chamfering head	
A30	30°
A60	60°
R chamfering head	
R10	R1.0
R16	R1.6
Ball nose	
SG	Sphere / high precision
BM	Ball / general purpose
BG	Ball / high precision

7 Additional feature	
I	Irregular pitch
A	for aluminum
R	for roughing
C	Combined edge

8 The number of flutes	
General	
02	2
06	6
Grooving head VST type	
3	3
4	4

9 Connection screw size	
S05	S05
S06	S06
S08	S08
S10	S10
S12	S12
S15	S15

TungMeister square head with 3 flutes for general purpose

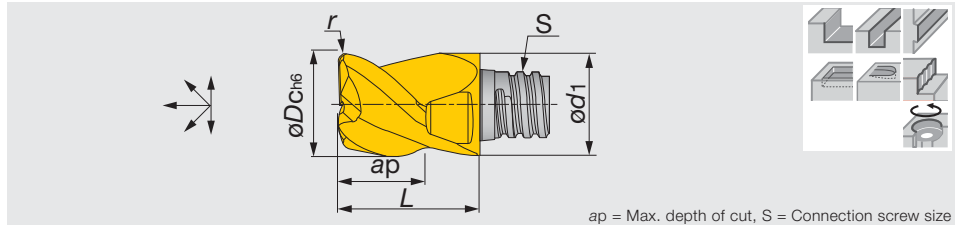

ap = Max. depth of cut, S = Connection screw size

Inch	AH725	z	Helx	øDc	ød1	Max. ap	r	S	L	Wrench	Torque*
VEE031L20R000-U03S05	●	3	45°	0.312	0.300	0.200	0	S05	0.390	KEYV-S05	5.16
VEE037L27R000-U03S06	●	3	45°	0.375	0.370	0.270	0	S06	0.512	KEYV-S06	5.16
VEE050L37R000-U03S08	●	3	45°	0.500	0.453	0.370	0	S08	0.650	KEYV-S08	5.16

*Torque: Recommended torque (lbf-ft) for clamping. Packing quantity = 2 pcs.

●: Line up

TungMeister square head with 4 flutes for general purposes

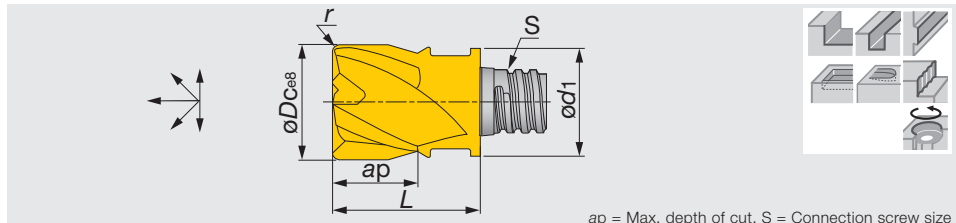

ap = Max. depth of cut, S = Connection screw size

Inch	AH725	z	Helx	øDc	ød1	Max. ap	r	S	L	Wrench	Torque*
VEE025L20R000-U04S05	●	4	45°	0.250	0.300	0.200	0.000	S05	0.390	KEYV-S05	5.16
VED031L20R015-U04S05	●	4	30°	0.312	0.300	0.200	0.015	S05	0.390	KEYV-S05	5.16
VED031L20R031-U04S05	●	4	30°	0.312	0.300	0.200	0.031	S05	0.390	KEYV-S05	5.16
VED031L20R062-U04S05	●	4	30°	0.312	0.300	0.200	0.062	S05	0.390	KEYV-S05	5.16
VEE031L20R000-U04S05	●	4	45°	0.312	0.300	0.200	0.000	S05	0.390	KEYV-S05	5.16
VEE031L20R015-U04S05	●	4	45°	0.312	0.300	0.200	0.015	S05	0.390	KEYV-S05	5.16
VEE031L20R031-U04S05	●	4	45°	0.312	0.300	0.200	0.031	S05	0.390	KEYV-S05	5.16
VEE031L20R062-U04S05	●	4	45°	0.312	0.300	0.200	0.062	S05	0.390	KEYV-S05	5.16
VED037L27R015-U04S06	●	4	30°	0.375	0.370	0.275	0.015	S06	0.512	KEYV-S06	7.38
VED037L27R031-U04S06	●	4	30°	0.375	0.370	0.275	0.031	S06	0.512	KEYV-S06	7.38
VEE037L27R000-U04S06	●	4	45°	0.375	0.370	0.275	0.000	S06	0.512	KEYV-S06	7.38
VEE037L27R015-U04S06	●	4	45°	0.375	0.370	0.275	0.015	S06	0.512	KEYV-S06	7.38
VEE037L27R031-U04S06	●	4	45°	0.375	0.370	0.275	0.031	S06	0.512	KEYV-S06	7.38
VEE037L27R062-U04S06	●	4	45°	0.375	0.370	0.275	0.062	S06	0.512	KEYV-S06	7.38
VEE037L47R000-U04S06	●	4	45°	0.375	0.370	0.470	0.000	S06	0.810	KEYV-S06	7.38
VED050L37R015-U04S08	●	4	30°	0.500	0.453	0.374	0.015	S08	0.650	KEYV-S08	11.06
VED050L37R031-U04S08	●	4	30°	0.500	0.453	0.374	0.031	S08	0.650	KEYV-S08	11.06
VEE050L37R000-U04S08	●	4	45°	0.500	0.453	0.374	0.000	S08	0.650	KEYV-S08	11.06
VEE050L37R015-U04S08	●	4	45°	0.500	0.453	0.374	0.015	S08	0.650	KEYV-S08	11.06
VEE050L37R031-U04S08	●	4	45°	0.500	0.453	0.374	0.031	S08	0.650	KEYV-S08	11.06
VEE050L37R062-U04S08	●	4	45°	0.500	0.453	0.374	0.062	S08	0.650	KEYV-S08	11.06
VED062L47R015-U04S10	●	4	30°	0.625	0.600	0.470	0.015	S10	0.810	KEYV-S10	20.65
VED062L47R031-U04S10	●	4	30°	0.625	0.600	0.470	0.031	S10	0.810	KEYV-S10	20.65
VED062L47R062-U04S10	●	4	30°	0.625	0.600	0.470	0.062	S10	0.810	KEYV-S10	20.65
VEE062L47R000-U04S10	●	4	45°	0.625	0.600	0.470	0.000	S10	0.810	KEYV-S10	20.65
VEE062L47R031-U04S10	●	4	45°	0.625	0.600	0.470	0.031	S10	0.810	KEYV-S10	20.65
VED075L62R015-U04S12	●	4	30°	0.750	0.720	0.620	0.015	S12	1.000	KEYV-S12	20.65
VED075L62R031-U04S12	●	4	30°	0.750	0.720	0.620	0.031	S12	1.000	KEYV-S12	20.65
VED075L62R062-U04S12	●	4	30°	0.750	0.720	0.620	0.062	S12	1.000	KEYV-S12	20.65
VEE075L62R000-U04S12	●	4	45°	0.750	0.720	0.620	0.000	S12	1.000	KEYV-S12	20.65
VEE075L62R031-U04S12	●	4	45°	0.750	0.720	0.620	0.031	S12	1.000	KEYV-S12	20.65
VEE100L87R000-U04S15	●	4	45°	1.000	0.957	0.866	0.000	S15	1.457	KEYV-W20	29.50
VED100L87R015-U04S15	●	4	30°	1.000	0.957	0.866	0.015	S15	1.457	KEYV-W20	29.50
VED100L87R031-U04S15	●	4	30°	1.000	0.957	0.866	0.031	S15	1.457	KEYV-W20	29.50
VED100L87R062-U04S15	●	4	30°	1.000	0.957	0.866	0.062	S15	1.457	KEYV-W20	29.50
VED100L87R125-U04S15	●	4	30°	1.000	0.957	0.866	0.125	S15	1.457	KEYV-W20	29.50

*Torque: Recommended torque (lbf-ft) for clamping. VED/VEE025 - 075: Packing quantity = 2 pcs. VED/VEE100: Packing quantity = 1 pc.

●: Line up

Reference pages

Standard cutting conditions → D179 - D180



Multi Function



Square



Multi Function

TUNGMEISTER

VEE**-03...

TungMeister square head with 3 flutes for key way

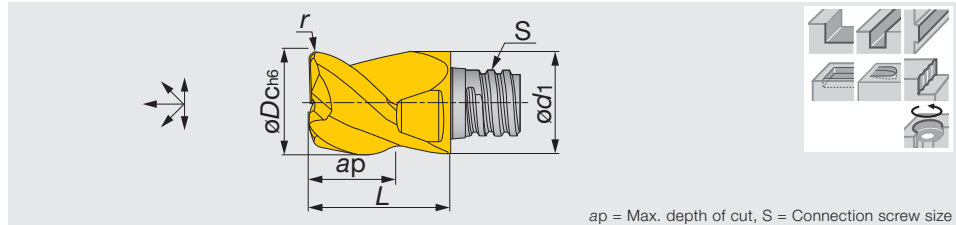

ap = Max. depth of cut, S = Connection screw size

Metric	AH725	z	Helx	øDc	ød1	Max. ap	r	S	L	Wrench	Torque*
VEE077L04.0R02-03S05	●	3	38°	7.7	7.7	4	0.2	S05	10	KEYV-S05	7
VEE097L05.0R03-03S06	●	3	38°	9.7	9.7	5	0.3	S06	13	KEYV-S06	10
VEE117L07.0R03-03S08	●	3	38°	11.7	11.7	7	0.3	S08	16.5	KEYV-S08	15
VEE157L08.0R03-03S10	●	3	38°	15.7	15.3	8	0.3	S10	20.5	KEYV-S10	28
VEE197L12.0R04-03S12	●	3	38°	19.7	18.3	12	0.4	S12	25.5	KEYV-S12	28

*Torque: Recommended torque (N-m) for clamping.
Packing quantity = 2 pcs.

●: Line up

TUNGMEISTER

VEE**I...

TungMeister square head with irregular pitch flute for chatter free cutting

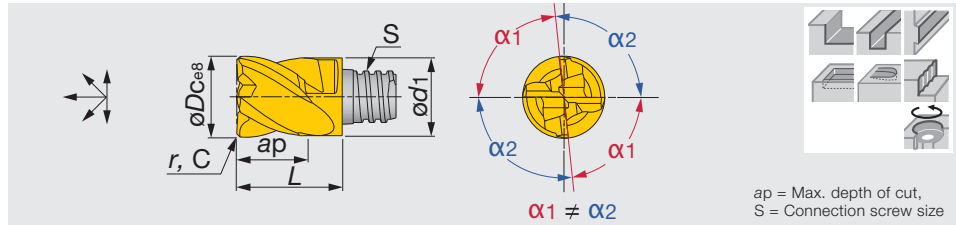

ap = Max. depth of cut, S = Connection screw size

Inch	AH725	z	Helx	øDc	ød1	Max. ap	r	C	S	L	Wrench	Torque*
VEE031L20C012IU04S05	●	4	38°	0.312	0.300	0.200	-	0.012	S05	0.390	KEYV-S05	5.16
VEE037L27C016IU04S06	●	4	38°	0.375	0.370	0.270	-	0.016	S06	0.510	KEYV-S06	7.38
VEE050L37C020IU04S08	●	4	38°	0.500	0.480	0.370	-	0.020	S08	0.650	KEYV-S08	11.06
VEE062L47C016IU05S10	●	5	38°	0.625	0.600	0.470	-	0.016	S10	0.810	KEYV-S10	20.65
VEE075L62C024IU04S12	●	4	38°	0.750	0.720	0.620	-	0.024	S12	1.000	KEYV-S12	20.65
VEE100L87C024IU04S15	●	4	38°	1.000	0.941	0.866	-	0.024	S15	1.457	KEYV-W20	29.50
VEE100L87R000IU04S15	●	4	38°	1.000	0.941	0.866	0.000	-	S15	1.457	KEYV-W20	29.50
VEE100L87R015IU04S15	●	4	38°	1.000	0.941	0.866	0.015	-	S15	1.457	KEYV-W20	29.50
VEE100L87R031IU04S15	●	4	38°	1.000	0.941	0.866	0.031	-	S15	1.457	KEYV-W20	29.50
VEE100L87R062IU04S15	●	4	38°	1.000	0.941	0.866	0.062	-	S15	1.457	KEYV-W20	29.50
VEE100L87R125IU04S15	●	4	38°	1.000	0.941	0.866	0.125	-	S15	1.457	KEYV-W20	29.50

*Torque: Recommended torque (lbf-ft) for clamping.
VEE031 - VEE075: Packing quantity = 2 pcs.
VEE100: Packing quantity = 1pc.

●: Line up

Reference pages

Standard cutting conditions → D179 - D180

TungMeister square head with serrated edges for roughing

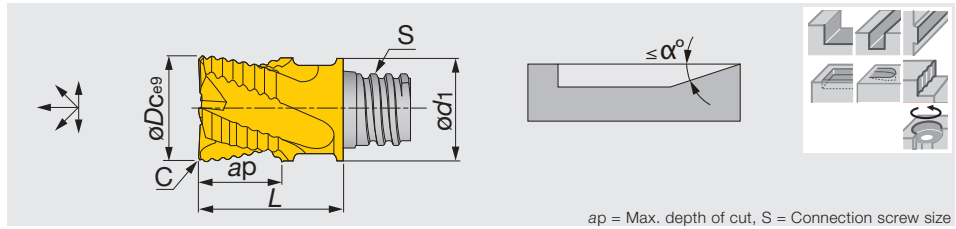

ap = Max. depth of cut, S = Connection screw size

Inch	AH725	z	Helix	ϕD_c	ϕd_1	Max. ap	C	S	L	α°	Wrench	Torque*
VEE031L20C012RU04S05	●	4	45°	0.312	0.300	0.200	0.012	S05	0.390	90	KEYV-S05	5.16
VEE037L27C012RU04S06	●	4	45°	0.375	0.360	0.270	0.012	S06	0.512	90	KEYV-S06	7.38
VEE050L37C016RU04S08	●	4	45°	0.500	0.453	0.370	0.016	S08	0.650	90	KEYV-S08	11.06
VEE062L47C024RU05S10	●	5	45°	0.625	0.600	0.470	0.024	S10	0.800	7	KEYV-S10	20.65
VEE075L62C024RU06S12	●	6	45°	0.750	0.720	0.620	0.024	S12	1.000	3	KEYV-S12	20.65
VEE100L87C024RU06S15	●	6	45°	1.000	0.941	0.866	0.024	S15	1.457	3	KEYV-W20	29.50

*Torque: Recommended torque (lbf-ft) for clamping.
VEE031 - VEE075: Packing quantity = 2 pcs.
VEE100: Packing quantity = 1pc.

●: Line up

TungMeister square head with combined edges of finish and serrated

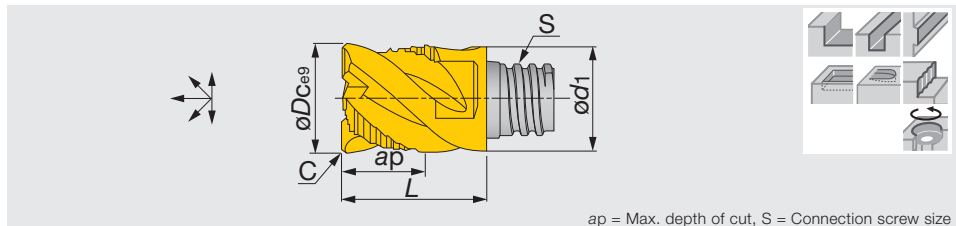

ap = Max. depth of cut, S = Connection screw size

Inch	AH725	z	Helix	ϕD_c	ϕd_1	Max. ap	C	S	L	Wrench	Torque*
VEE031L20C012CU04S05	●	4	45°	0.312	0.300	0.200	0.012	S05	0.390	KEYV-S05	5.16
VEE037L27C012CU04S06	●	4	45°	0.375	0.360	0.270	0.012	S06	0.510	KEYV-S06	7.38
VEE050L37C016CU04S08	●	4	45°	0.500	0.480	0.369	0.016	S08	0.650	KEYV-S08	11.06
VEE062L47C024CU04S10	●	4	45°	0.625	0.600	0.470	0.024	S10	0.800	KEYV-S10	20.65
VEE075L62C024CU04S12	●	4	45°	0.750	0.720	0.620	0.024	S12	1.000	KEYV-S12	20.65
VEE100L87C024CU04S15	●	4	45°	1.000	0.941	0.866	0.024	S15	1.457	KEYV-W20	29.50

*Torque: Recommended torque (lbf-ft) for clamping.
VEE031 - VEE075: Packing quantity = 2 pcs.
VEE100: Packing quantity = 1pc.

●: Line up

Reference pages

Standard cutting conditions → D179 - D180



Multi Function

TUNGMEISTER

VEE**A02...

TungMeister square head with 2 flutes for aluminum machining

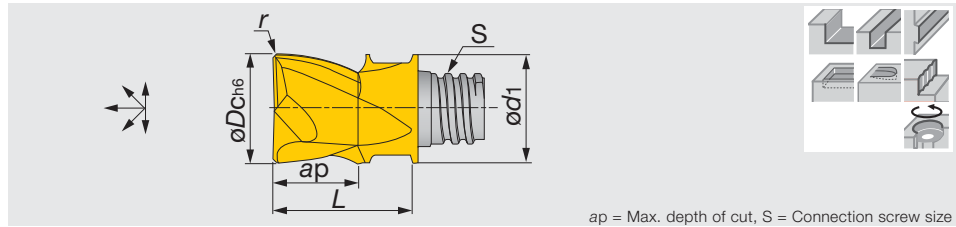

Inch	KS15F	z	Helx	øDc	ød1	Max. ap	r	S	L	Wrench	Torque*
VEE037L27R000AU02S06	●	2	45°	0.375	0.360	0.270	0.000	S06	0.510	KEYV-S06	7.38
VEE037L27R020AU02S06	●	2	45°	0.375	0.360	0.270	0.020	S06	0.510	KEYV-S06	7.38
VEE050L37R000AU02S08	●	2	45°	0.500	0.480	0.370	0.000	S08	0.650	KEYV-S08	11.06
VEE050L37R020AU02S08	●	2	45°	0.500	0.480	0.370	0.020	S08	0.650	KEYV-S08	11.06

*Torque: Recommended torque (lbf-ft) for clamping.
Packing quantity = 2 pcs.

●: Line up

TUNGMEISTER

VEE**A03...

TungMeister square head with 3 flutes for aluminum machining

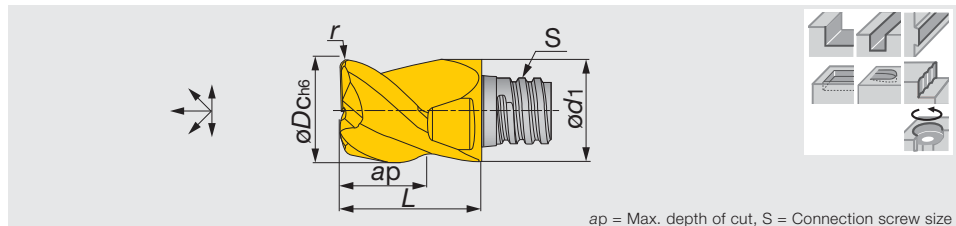

Square

Inch	KS15F	z	Helx	øDc	ød1	Max. ap	r	S	L	Wrench	Torque*
VEE031L20R020AU03S05	●	3	45°	0.312	0.300	0.200	0.020	S05	0.390	KEYV-S05	5.16
VEE037L20R031AU03S06	●	3	45°	0.375	0.360	0.230	0.031	S06	0.510	KEYV-S06	7.38
VEE037L20R062AU03S06	●	3	45°	0.375	0.360	0.230	0.062	S06	0.510	KEYV-S06	7.38
VEE050L31R031AU03S08	●	3	45°	0.500	0.480	0.310	0.031	S08	0.650	KEYV-S08	11.06
VEE050L31R062AU03S08	●	3	45°	0.500	0.480	0.310	0.062	S08	0.650	KEYV-S08	11.06
VEE050L31R094AU03S08	●	3	45°	0.500	0.480	0.310	0.094	S08	0.650	KEYV-S08	11.06
VEE050L31R125AU03S08	●	3	45°	0.500	0.480	0.310	0.125	S08	0.650	KEYV-S08	11.06
VEE062L39R000AU03S10	●	3	45°	0.625	0.600	0.390	0.000	S10	0.810	KEYV-S10	20.65
VEE062L39R031AU03S10	●	3	45°	0.625	0.600	0.390	0.031	S10	0.810	KEYV-S10	20.65
VEE062L39R062AU03S10	●	3	45°	0.625	0.600	0.390	0.062	S10	0.810	KEYV-S10	20.65
VEE062L39R094AU03S10	●	3	45°	0.625	0.600	0.390	0.094	S10	0.810	KEYV-S10	20.65
VEE062L39R125AU03S10	●	3	45°	0.625	0.600	0.390	0.125	S10	0.810	KEYV-S10	20.65
VEE075L47R062AU03S12	●	3	45°	0.750	0.720	0.470	0.062	S12	1.000	KEYV-S12	20.65
VEE075L47R094AU03S12	●	3	45°	0.750	0.720	0.470	0.094	S12	1.000	KEYV-S12	20.65
VEE075L47R125AU03S12	●	3	45°	0.750	0.720	0.470	0.125	S12	1.000	KEYV-S12	20.65
VEE075L50R008AU03S12	●	3	45°	0.750	0.720	0.500	0.008	S12	1.000	KEYV-S12	20.65
VEE075L50R020AU03S12	●	3	45°	0.750	0.720	0.500	0.020	S12	1.000	KEYV-S12	20.65

*Torque: Recommended torque (lbf-ft) for clamping.
Packing quantity = 2 pcs.

●: Line up

Reference pages

Standard cutting conditions → D179 - D180

TungMeister square head with 6 flutes for difficult-to-cut material machining

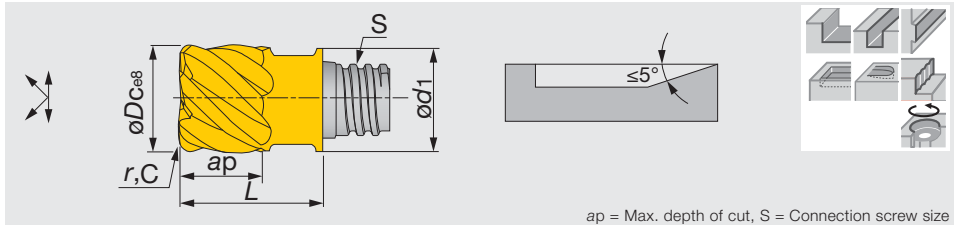

ap = Max. depth of cut, S = Connection screw size

Inch	AH725	AH750	z	Helix	$\varnothing D_c$	$\varnothing d_1$	Max. ap	r	C	S	L	Wrench	Torque*
VED031L20R015-U06S05	●		6	30°	0.312	0.300	0.200	0.015	-	S05	0.390	KEYV-S05	5.16
VEE031L20R000-U06S05	●		6	45°	0.312	0.300	0.200	0.000	-	S05	0.390	KEYV-S05	5.16
VEE031L20R031-U06S05	●		6	45°	0.312	0.300	0.200	0.031	-	S05	0.390	KEYV-S05	5.16
VEE031L20C004-U06S05		●	6	50°	0.312	0.300	0.200	-	0.004	S05	0.390	KEYV-S05	5.16
VED037L27R015-U06S06			6	30°	0.375	0.370	0.275	0.015	-	S06	0.512	KEYV-S06	7.38
VED037L27R031-U06S06	●		6	30°	0.375	0.370	0.275	0.031	-	S06	0.512	KEYV-S06	7.38
VEE037L27R000-U06S06	●		6	45°	0.375	0.370	0.275	0.000	-	S06	0.512	KEYV-S06	7.38
VEE037L27R015-U06S06	●		6	45°	0.375	0.370	0.275	0.015	-	S06	0.512	KEYV-S06	7.38
VEE037L27R031-U06S06	●		6	45°	0.375	0.370	0.275	0.031	-	S06	0.512	KEYV-S06	7.38
VEE037L27R062-U06S06	●		6	45°	0.375	0.370	0.275	0.062	-	S06	0.512	KEYV-S06	7.38
VEE037L27C004-U06S06		●	6	50°	0.375	0.370	0.275	-	0.004	S06	0.510	KEYV-S06	7.38
VED050L37R015-U06S08	●		6	30°	0.500	0.453	0.374	0.015	-	S08	0.650	KEYV-S08	7.38
VED050L37R031-U06S08	●		6	30°	0.500	0.453	0.374	0.031	-	S08	0.650	KEYV-S08	11.06
VEE050L37R000-U06S08	●		6	45°	0.500	0.453	0.374	0.000	-	S08	0.650	KEYV-S08	11.06
VEE050L37R015-U06S08	●		6	45°	0.500	0.453	0.374	0.015	-	S08	0.650	KEYV-S08	11.06
VEE050L37R031-U06S08	●		6	45°	0.500	0.453	0.374	0.031	-	S08	0.650	KEYV-S08	11.06
VEE050L37R062-U06S08	●		6	45°	0.500	0.453	0.374	0.062	-	S08	0.650	KEYV-S08	11.06
VEE050L37C004-U06S08		●	6	50°	0.500	0.453	0.374	-	0.004	S08	0.650	KEYV-S08	11.06

*Torque: Recommended torque (lbf-ft) for clamping.
Packing quantity = 2 pcs.

●: Line up



Multi Function

TungMeister square head with 8, 10 flutes for difficult-to-cut material machining

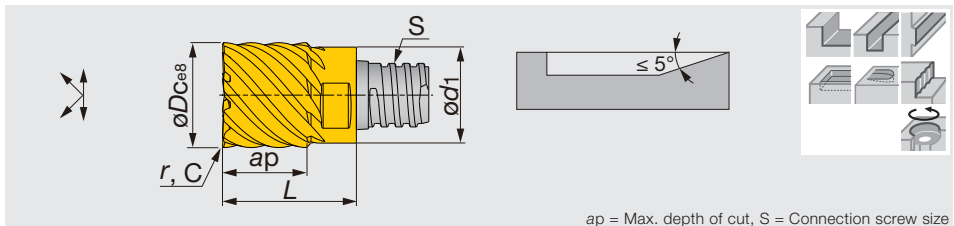

ap = Max. depth of cut, S = Connection screw size

Inch	AH725	AH750	z	Helix	$\varnothing D_c$	$\varnothing d_1$	Max. ap	r	C	S	L	Wrench	Torque*
VED062L47R000-U08S10	●		8	30°	0.625	0.600	0.470	0.000	-	S10	0.810	KEYV-S10	20.65
VED062L47R015-U08S10	●		8	30°	0.625	0.600	0.470	0.015	-	S10	0.810	KEYV-S10	20.65
VED062L47R031-U08S10	●		8	30°	0.625	0.600	0.470	0.031	-	S10	0.810	KEYV-S10	20.65
VED062L47R062-U08S10	●		8	30°	0.625	0.600	0.470	0.062	-	S10	0.810	KEYV-S10	20.65
VEE062L47C008-U08S10		●	8	45°	0.625	0.600	0.470	-	0.008	S10	0.810	KEYV-S10	20.65
VED075L62R031-U10S12	●		10	30°	0.750	0.720	0.620	0.031	-	S12	1.000	KEYV-S12	20.65
VED075L62R062-U10S12	●		10	30°	0.750	0.720	0.620	0.062	-	S12	1.000	KEYV-S12	20.65
VEE075L62C008-U10S12		●	10	45°	0.750	0.720	0.620	-	0.008	S12	1.000	KEYV-S12	20.65
VED100L87R031-U10S15	●		10	30°	1.000	0.941	0.866	0.031	-	S15	1.457	KEYV-W20	29.50
VED100L87R062-U10S15	●		10	30°	1.000	0.941	0.866	0.062	-	S15	1.457	KEYV-W20	29.50

*Torque: Recommended torque (lbf-ft) for clamping.
VEE/VED062 - 075: Packing quantity = 2 pcs.
VED100: Packing quantity = 1pc.

●: Line up



Square

Reference pages

Standard cutting conditions → D179 - D180



Multi Function

TUNGMEISTER

VRB**-02...

TungMeister radius head with 2 pressed flutes

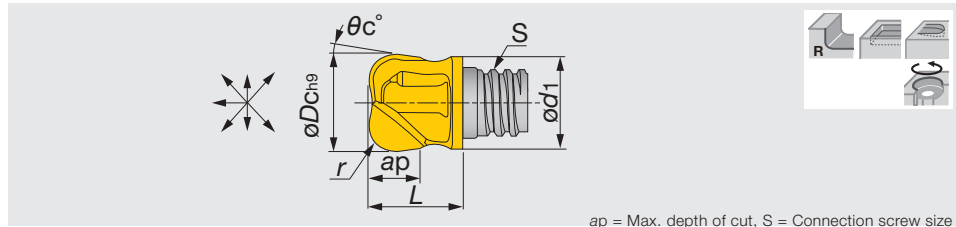

Inch	AH725	z	Helx	ϕD_c	ϕd_1	Max. ap	r	θ_c°	S	L	Wrench	Torque*
VRB062L31R187-U02S10	●	2	0°	0.625	0.600	0.310	0.187	0.197	S06	0.580	KEYV-S06	7.38
VRB075L45R250-U02S12	●	2	0°	0.750	0.720	0.450	0.250	0.197	S06	0.680	KEYV-S06	7.38
VRB075L45R312-U02S12	●	2	0°	0.750	0.720	0.450	0.312	0.276	S06	0.680	KEYV-S06	7.38

Note: Suitable for contouring operation. Some heads require different wrench sizes.

*Torque: Recommended torque (lbf-ft) for clamping.

Packing quantity = 2 pcs.

●: Line up

TUNGMEISTER

VRD**-06...

TungMeister radius head with 6 ground flutes

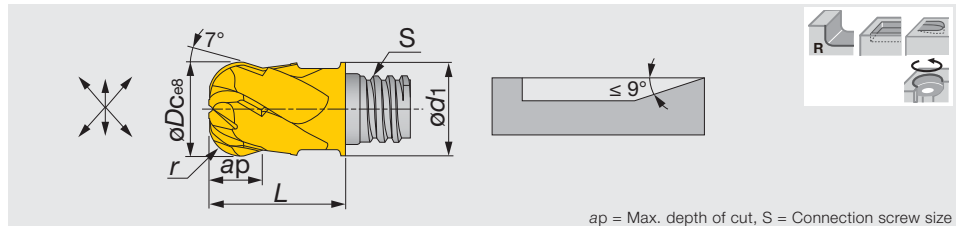

Inch	AH725	z	Helx	ϕD_c	ϕd_1	Max. ap	r	S	L	Wrench	Torque*
VRD031L16R078-U06S05	●	6	30°	0.312	0.300	0.160	0.078	S05	0.390	KEYV-S05	5.16
VRD037L19R031-U06S06	●	6	30°	0.375	0.360	0.190	0.031	S06	0.510	KEYV-S06	7.38
VRD037L19R062-U06S06	●	6	30°	0.375	0.360	0.190	0.062	S06	0.510	KEYV-S06	7.38
VRD037L19R125-U06S06	●	6	30°	0.375	0.360	0.190	0.125	S06	0.510	KEYV-S06	7.38
VRD050L27R062-U06S08	●	6	30°	0.500	0.480	0.270	0.062	S08	0.650	KEYV-S08	11.06
VRD050L27R125-U06S08	●	6	30°	0.500	0.480	0.270	0.125	S08	0.650	KEYV-S08	11.06
VRD050L27R156-U06S08	●	6	30°	0.500	0.480	0.270	0.156	S08	0.650	KEYV-S08	11.06
VRD062L35R200-U06S10	●	6	30°	0.625	0.600	0.350	0.200	S10	0.807	KEYV-S10	20.65

*Torque: Recommended torque (lbf-ft) for clamping.

Packing quantity = 2 pcs.

●: Line up



Radius

Reference pages

Standard cutting conditions → D179 - D180

STANDARD CUTTING CONDITIONS

Shoulder milling (VEE: 3 flutes, VED/VEE: 4 flutes, VEE-A, VEE-I, VEE-R, VEE-C, VRB, VRC, VRD)



Multi Function

ISO	Workpiece material	Hardness	Cutting speed Vc (sfm)	Feed per tooth: fz (ipt)								Depth of cut ap (in)	Pick feed Pf (in)
				Tool diameter: øDc (in)									
				0.250"	0.312"	0.375"	0.500"	0.625"	0.750"	1.000"			
P	Low carbon steels 1045, 1055, etc.	- 300 HB	260 - 590	0.001 - 0.003	0.001 - 0.004	0.003 - 0.005	0.003 - 0.005	0.004 - 0.006	0.004 - 0.007	0.004 - 0.007	0.6 x øDc	0.25 x øDc	
	High carbon steels 4140, 5120, etc.	- 300 HB	200 - 460	0.001 - 0.003	0.001 - 0.004	0.003 - 0.005	0.003 - 0.005	0.004 - 0.006	0.004 - 0.007	0.004 - 0.007	0.6 x øDc	0.25 x øDc	
	Prehardened steel PX5, NAK80, etc.	30 - 40 HRC	200 - 400	0.001 - 0.003	0.001 - 0.004	0.003 - 0.005	0.003 - 0.005	0.004 - 0.006	0.004 - 0.007	0.004 - 0.007	0.6 x øDc	0.25 x øDc	
M	Stainless steels S30400, S31600, etc.	- 200 HB	130 - 330	0.001 - 0.003	0.001 - 0.004	0.003 - 0.005	0.003 - 0.005	0.004 - 0.006	0.004 - 0.007	0.004 - 0.007	0.6 x øDc	0.25 x øDc	
K	Grey cast irons No.250B, No.300B, etc.	150 - 250 HB	260 - 660	0.001 - 0.003	0.001 - 0.004	0.003 - 0.005	0.003 - 0.005	0.004 - 0.006	0.004 - 0.007	0.004 - 0.007	0.6 x øDc	0.25 x øDc	
	Ductile cast irons 60-40-18, etc.	150 - 250 HB	260 - 660	0.001 - 0.003	0.001 - 0.004	0.003 - 0.005	0.003 - 0.005	0.004 - 0.006	0.004 - 0.007	0.004 - 0.007	0.6 x øDc	0.25 x øDc	
N	Aluminum alloys Si < 13%	-	660 - 2297	0.001 - 0.003	0.001 - 0.004	0.003 - 0.005	0.003 - 0.005	0.004 - 0.006	0.004 - 0.007	0.004 - 0.007	0.6 x øDc	0.25 x øDc	
	Aluminum alloys Si ≥ 13%	-	330 - 980	0.001 - 0.003	0.001 - 0.004	0.003 - 0.005	0.003 - 0.005	0.004 - 0.006	0.004 - 0.007	0.004 - 0.007	0.6 x øDc	0.25 x øDc	
S	Titanium alloys Ti-6Al-4V, etc.	-	130 - 260	0.001 - 0.003	0.001 - 0.004	0.003 - 0.005	0.003 - 0.005	0.004 - 0.006	0.004 - 0.007	0.004 - 0.007	0.6 x øDc	0.05 x øDc	
	Heat-resistant alloys Inconel 718, etc.	-	66 - 130	0.001 - 0.003	0.001 - 0.004	0.003 - 0.005	0.003 - 0.005	0.004 - 0.006	0.004 - 0.007	0.004 - 0.007	0.6 x øDc	0.05 x øDc	
H	Hardened steel H13, etc.	40 - 50 HRC	130 - 260	0.001 - 0.003	0.001 - 0.004	0.003 - 0.005	0.003 - 0.005	0.004 - 0.006	0.004 - 0.007	0.004 - 0.007	0.6 x øDc	0.05 x øDc	
	Hardened steel D2, etc.	50 - 60 HRC	66 - 200	0.001 - 0.003	0.001 - 0.004	0.003 - 0.005	0.003 - 0.005	0.004 - 0.006	0.004 - 0.007	0.004 - 0.007	0.6 x øDc	0.05 x øDc	

Slot milling (VEE: 3 flutes, VED/VEE: 4 flutes, VEE-A, VEE-I, VEE-R, VEE-C, VRB, VRC, VRD)

ISO	Workpiece material	Hardness	Cutting speed Vc (sfm)	Feed per tooth: fz (ipt)								Depth of cut ap (in)
				Tool diameter: øDc (in)								
				0.250"	0.312"	0.375"	0.500"	0.625"	0.750"	1.000"		
P	Low carbon steels 1045, 1055, etc.	- 300 HB	260 - 590	0.001 - 0.003	0.001 - 0.004	0.003 - 0.005	0.003 - 0.005	0.004 - 0.006	0.004 - 0.007	0.003 - 0.004	0.5 x øDc	
	High carbon steels 4140, 5120, etc.	- 300 HB	200 - 460	0.001 - 0.003	0.001 - 0.004	0.003 - 0.005	0.003 - 0.005	0.004 - 0.006	0.004 - 0.007	0.003 - 0.004	0.5 x øDc	
	Prehardened steel PX5, NAK80, etc.	30 - 40 HRC	200 - 400	0.001 - 0.003	0.001 - 0.004	0.003 - 0.005	0.003 - 0.005	0.004 - 0.006	0.004 - 0.007	0.003 - 0.004	0.5 x øDc	
M	Stainless steels S30400, S31600, etc.	- 200 HB	130 - 330	0.001 - 0.003	0.001 - 0.004	0.003 - 0.005	0.003 - 0.005	0.004 - 0.006	0.004 - 0.007	0.003 - 0.004	0.5 x øDc	
K	Grey cast irons No.250B, No.300B, etc.	150 - 250 HB	260 - 660	0.001 - 0.003	0.001 - 0.004	0.003 - 0.005	0.003 - 0.005	0.004 - 0.006	0.004 - 0.007	0.003 - 0.004	0.5 x øDc	
	Ductile cast irons 60-40-18, etc.	150 - 250 HB	260 - 660	0.001 - 0.003	0.001 - 0.004	0.003 - 0.005	0.003 - 0.005	0.004 - 0.006	0.004 - 0.007	0.003 - 0.004	0.5 x øDc	
N	Aluminum alloys Si < 13%	-	660 - 2297	0.001 - 0.003	0.001 - 0.004	0.003 - 0.005	0.003 - 0.005	0.004 - 0.006	0.004 - 0.007	0.003 - 0.004	0.5 x øDc	
	Aluminum alloys Si ≥ 13%	-	330 - 980	0.001 - 0.003	0.001 - 0.004	0.003 - 0.005	0.003 - 0.005	0.004 - 0.006	0.004 - 0.007	0.003 - 0.004	0.5 x øDc	
S	Titanium alloys Ti-6Al-4V, etc.	-	130 - 260	0.001 - 0.003	0.001 - 0.004	0.003 - 0.005	0.003 - 0.005	0.004 - 0.006	0.004 - 0.007	0.003 - 0.004	0.5 x øDc	
	Heat-resistant alloys Inconel 718, etc.	-	66 - 130	0.001 - 0.003	0.001 - 0.004	0.003 - 0.005	0.003 - 0.005	0.004 - 0.006	0.004 - 0.007	0.003 - 0.004	0.5 x øDc	
H	Hardened steel H13, etc.	40 - 50 HRC	130 - 260	0.001 - 0.003	0.001 - 0.004	0.003 - 0.005	0.003 - 0.005	0.004 - 0.006	0.004 - 0.007	0.003 - 0.004	0.2 x øDc	
	Hardened steel D2, etc.	50 - 60 HRC	66 - 200	0.001 - 0.003	0.001 - 0.004	0.003 - 0.005	0.003 - 0.005	0.004 - 0.006	0.004 - 0.007	0.003 - 0.004	0.2 x øDc	



Square



Radius



Multi Function

STANDARD CUTTING CONDITIONS

Shoulder milling (VED / VEE: 6 flutes, VED / VEE: 8, 10 flutes)

ISO	Workpiece material	Hardness	Cutting speed Vc (sfm)	Feed per tooth: fz (ipt)						Depth of cut ap (in)	Pick feed Pf (in)
				Tool diameter: ϕD_c (in)							
				0.312"	0.375"	0.500"	0.625"	0.750"	1.000"		
S	Titanium alloys Ti-6Al-4V, etc.	-	200 - 400	0.002 - 0.004	0.003 - 0.005	0.003 - 0.005	0.004 - 0.006	0.004 - 0.007	0.004 - 0.007	0.6 x ϕD_c	0.02 x ϕD_c
	Heat-resistant alloys Inconel 718, etc.	-	100 - 200	0.002 - 0.004	0.003 - 0.005	0.003 - 0.005	0.004 - 0.006	0.004 - 0.007	0.004 - 0.007	0.6 x ϕD_c	0.02 x ϕD_c
H	Hardened steel H13, H19, etc.	40 - 50 HRC	260 - 530	0.002 - 0.004	0.003 - 0.005	0.003 - 0.005	0.004 - 0.006	0.004 - 0.007	0.004 - 0.007	0.6 x ϕD_c	0.02 x ϕD_c
	Hardened steel D2, etc.	50 - 60 HRC	130 - 300	0.002 - 0.004	0.003 - 0.005	0.003 - 0.005	0.004 - 0.006	0.004 - 0.007	0.004 - 0.007	0.6 x ϕD_c	0.02 x ϕD_c



Square

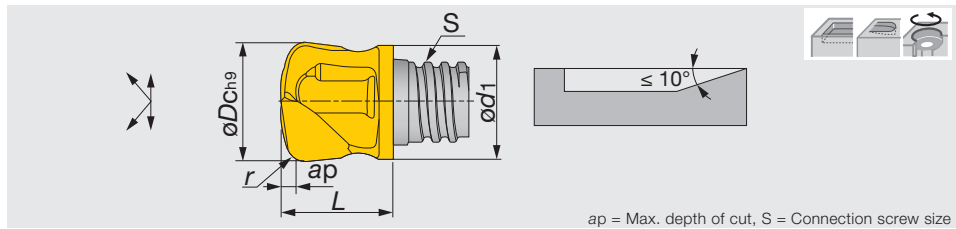

Inch	AH725	z	Helix	ϕD_c	ϕd_1	Max. ap	r ⁽¹⁾	S	L	Wrench	Torque*
VFX037L02R060-U02S06	●	2	0°	0.375	0.360	0.020	0.060	S06	0.490	KEYV-S06	7.38
VFX050L04R080-U02S08	●	2	0°	0.500	0.480	0.040	0.080	S08	0.590	KEYV-S08	11.06
VFX075L06R080-U02S12	●	2	0°	0.750	0.720	0.059	0.080	S12	0.685	KEYV-S10	20.65

(1) Corner radius for CAM programming

Note: For VFX head, taper neck shank or Tungsten shank should be recommended.

*Torque: Recommended torque (lbf-ft) for clamping.

Packing quantity = 2 pcs.

●: Line up

STANDARD CUTTING CONDITIONS

High feed milling (VFX)

ISO	Workpiece material	Hardness	Cutting speed Vc (sfm)	$\phi 0.375''$		$\phi 0.500''$		$\phi 0.750''$		Width of cut ae (in)
				Feed per tooth fz (ipt)	Depth of cut ap (in)	Feed per tooth fz (ipt)	Depth of cut ap (in)	Feed per tooth fz (ipt)	Depth of cut ap (in)	
P	Low carbon steels 1045, 1055, etc.	- 300 HB	330 - 660	0.012 - 0.028	0.020	0.016 - 0.031	0.020	0.024 - 0.040	0.040	0.6 x ϕD_c
	High carbon steels 4140, 5120, etc.	- 300 HB	260 - 590	0.008 - 0.024	0.020	0.012 - 0.028	0.020	0.020 - 0.035	0.040	0.6 x ϕD_c
	Prehardened steel PX5, NAK80, etc.	30 - 40 HRC	260 - 530	0.008 - 0.020	0.016	0.008 - 0.02	0.016	0.012 - 0.024	0.030	0.6 x ϕD_c
M	Stainless steels S30400, S31600, etc.	- 200 HB	200 - 330	0.008 - 0.024	0.016	0.008 - 0.024	0.016	0.012 - 0.028	0.030	0.6 x ϕD_c
K	Grey cast irons No.250B, No.300B, etc.	150 - 250 HB	330 - 720	0.012 - 0.028	0.020	0.016 - 0.031	0.030	0.024 - 0.040	0.040	0.6 x ϕD_c
	Ductile cast irons 60-40-18, etc.	150 - 250 HB	330 - 720	0.008 - 0.024	0.020	0.012 - 0.028	0.030	0.020 - 0.035	0.040	0.6 x ϕD_c
S	Titanium alloys Ti-6Al-4V, etc.	-	130 - 260	0.008 - 0.020	0.016	0.008 - 0.020	0.016	0.008 - 0.024	0.020	0.25 x ϕD_c
	Heat-resistant alloys Inconel 718, etc.	-	66 - 130	0.004 - 0.012	0.012	0.004 - 0.012	0.012	0.004 - 0.012	0.016	0.25 x ϕD_c
H	Hardened steel H13, etc.	40 - 50 HRC	130 - 260	0.008 - 0.016	0.012	0.008 - 0.016	0.012	0.012 - 0.020	0.016	0.45 x ϕD_c
	Hardened steel D2, etc.	50 - 60 HRC	66 - 200	0.004 - 0.008	0.008	0.004 - 0.008	0.008	0.004 - 0.012	0.012	0.25 x ϕD_c



Multi Function



Radius



Multi Function

TUNGMEISTER

VBB**-BM...

TungMeister ball nose head with pressed edge for roughing

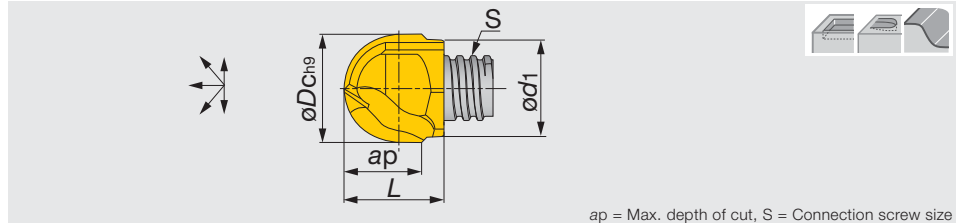

Inch	AH725	z	Helx	ϕD_c	ϕd_1	Max. ap	S	L	Wrench	Torque*
VBB0312L20-BM-U02S05	●	2	0°	0.312	0.300	0.310	S05	0.390	KEYV-S05	5.16
VBB0375L27-BM-U02S06	●	2	0°	0.375	0.360	0.380	S06	0.478	KEYV-S06	7.38
VBB0500L37-BM-U02S08	●	2	0°	0.500	0.453	0.512	S08	0.646	KEYV-S08	11.06
VBB0625L47-BM-U02S10	●	2	0°	0.625	0.600	0.630	S10	0.750	KEYV-S10	20.65

● For roughing

*Torque: Recommended torque (lbf-ft) for clamping.

Packing quantity = 2 pcs.

●: Line up

TUNGMEISTER

VBB**-BG...

TungMeister ball nose head with ground edge for semi-finishing

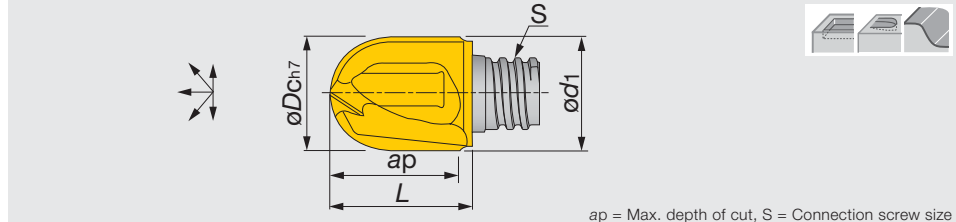

Inch	AH750	z	Helx	ϕD_c	ϕd_1	Max. ap	S	L	Wrench	Torque*
VBB0312L31-BG-U02S05	●	2	0°	0.312	0.300	0.312	S05	0.390	KEYV-S05	5.16
VBB0375L37-BG-U02S06	●	2	0°	0.375	0.360	0.380	S06	0.480	KEYV-S06	7.38
VBB0500L50-BG-U02S08	●	2	0°	0.500	0.480	0.500	S08	0.640	KEYV-S08	11.06
VBB0625L50-BG-U02S10	●	2	0°	0.625	0.598	0.630	S10	0.752	KEYV-S10	20.65

*Torque: Recommended torque (lbf-ft) for clamping.

Packing quantity = 2 pcs.

●: Line up



Ball

TUNGMEISTER

VBD**-BG...

TungMeister ball nose head with 2 flutes and helical ground edge for finishing

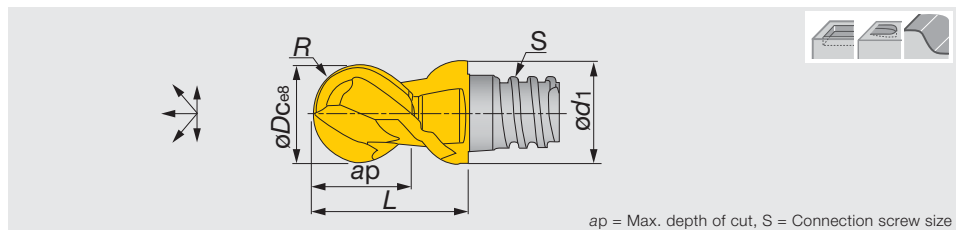

Inch	AH725	z	Helx	ϕD_c	ϕd_1	Max. ap	R	S	L	Wrench	Torque*
VBD0312L20-BG-U02S05	●	2	30°	0.312	0.300	0.200	0.156	S05	0.350	KEYV-S05	5.16
VBD0375L27-BG-U02S06	●	2	30°	0.375	0.360	0.275	0.188	S06	0.512	KEYV-S06	7.38
VBD0500L37-BG-U02S08	●	2	30°	0.500	0.453	0.374	0.249	S08	0.650	KEYV-S08	11.06
VBD0625L35-BG-U02S10	●	2	30°	0.625	0.600	0.470	0.313	S10	0.800	KEYV-S10	20.65

● The tolerance of R : (1) ± 0.0003 " (2) ± 0.0004 "

*Torque: Recommended torque (lbf-ft) for clamping.

Packing quantity = 2 pcs.

●: Line up

Reference pages

Standard cutting conditions → **D184**

TungMeister ball nose head with 4 flutes and helical ground edge for finishing

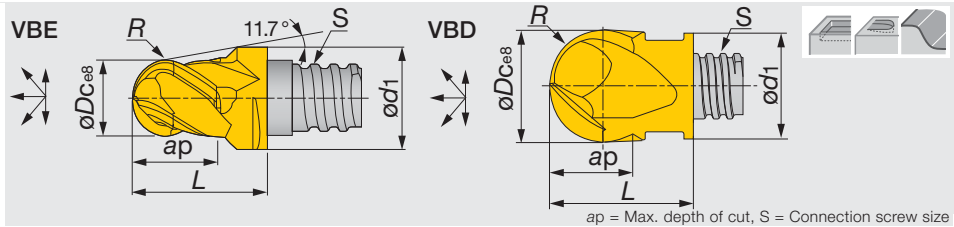

Inch	AH725	z	Helx	øDc	ød1	Max. ap	R	S	L	Wrench	Torque*
VBE0250L20-BG-U04S05	●	4	45°	0.250	0.300	0.200	0.124	S05	0.390	KEYV-S05	5.16
VBE0312L20-BG-U04S05	●	4	30°	0.312	0.300	0.200	0.156	S05	0.350	KEYV-S05	5.16
VBD0375L27-BG-U04S06	●	4	30°	0.375	0.360	0.275	0.188	S06	0.512	KEYV-S06	7.38
VBD0500L37-BG-U04S08	●	4	30°	0.500	0.453	0.374	0.249	S08	0.650	KEYV-S08	11.06
VBD0625L47-BG-U04S10	●	4	30°	0.625	0.600	0.470	0.313	S10	0.800	KEYV-S10	20.65
VBD0750L62-BG-U04S12	●	4	30°	0.750	0.720	0.620	0.374	S12	1.000	KEYV-S12	20.65
VBD100L87-BG-U04S15	●	4	30°	1.000	0.941	0.866	0.499	S15	1.457	KEYV-W20	29.50

• The tolerance of R : (1) ± 0.0004 (2) ± 0.0005 (3) ± 0.0008

*Torque: Recommended torque (lbf-ft) for clamping.

VBE0250,0312/VBD0375 - 0750: Packing quantity = 2 pcs. VBD100: Packing quantity = 1pc.

●: Line up

TungMeister ball nose head with spherical designed edge, available for pull-cutting on the wall

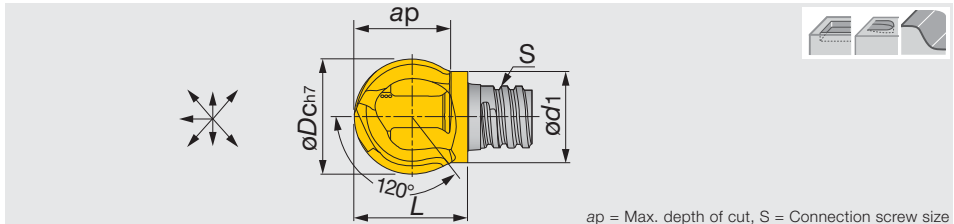

Inch	AH725	z	Helx	øDc	ød1	Max. ap	S	L	Wrench	Torque**
VBB0375L30-SG-U02S05	●	2	0°	0.375	0.300	0.315	S05	0.389	KEYV-S05	5.16
VBB0500L40-SG-U02S06	●	2	0°	0.500	0.378	0.378	S06	0.480	*KEYV-S08	7.38
VBB0625L50-SG-U02S08	●	2	0°	0.625	0.480	0.508	S08	0.606	*KEYV-S10	11.06
VBB0750L60-SG-U02S10	●	2	0°	0.750	0.600	0.634	S10	0.710	KEYV-S10	20.65

• For pull-cutting on the vertical wall

* Some heads require different size of wrench.

**Torque: Recommended torque (lbf-ft) for clamping. Packing quantity = 2 pcs.

●: Line up

TungMeister ball nose head with 2 flutes and helical ground edge for Al machining

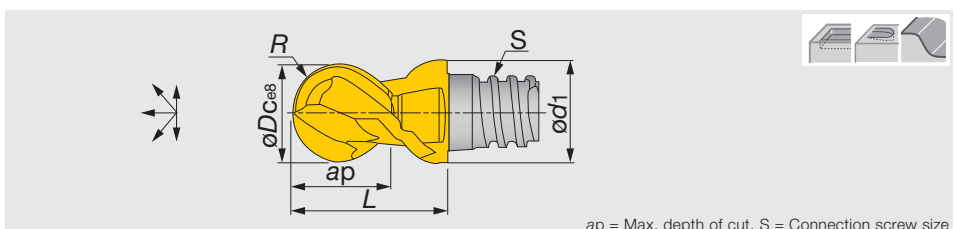

Inch	KS15F	z	Helx	øDc	ød1	Max. ap	R	S	L	Wrench	Torque*
VBE0312L20-BGAU02S05	●	2	45°	0.312	0.300	0.200	0.156	S05	0.390	KEYV-S05	5.16
VBE0375L27-BGAU02S06	●	2	45°	0.375	0.360	0.270	0.187	S06	0.510	KEYV-S06	7.38
VBE0500L37-BGAU02S08	●	2	45°	0.500	0.480	0.370	0.249	S08	0.650	KEYV-S08	11.06
VBE0625L47-BGAU02S10	●	2	45°	0.625	0.600	0.470	0.312	S10	0.800	KEYV-S10	20.65
VBE0750L50-BGAU02S12	●	2	45°	0.750	0.720	0.500	0.374	S12	1.000	KEYV-S12	20.65

• The tolerance of R : (1) ± 0.0004 (2) ± 0.0005

*Torque: Recommended torque (lbf-ft) for clamping. Packing quantity = 2 pcs.

●: Line up

Reference pages

Standard cutting conditions → D184



Multi Function



Ball



Multi Function

STANDARD CUTTING CONDITIONS

Standard cutting conditions: Profiling for roughing (VBB-BM / BG / SG, VBD-BG, VBE-BGA)

ISO	Workpiece material	Hardness	Cutting speed Vc (sfm)	Feed per tooth: fz (ipt)							Depth of cut ap (in)	Pick feed Pf (in)
				Tool diameter: øDc (in)								
				0.250"	0.312"	0.375"	0.500"	0.625"	0.750"	1.000"		
P	Low carbon steels	- 200	328 - 656	0.001 - 0.003	0.002 - 0.003	0.002 - 0.004	0.002 - 0.004	0.003 - 0.005	0.003 - 0.006	0.003 - 0.006	0.012 x øDc	0.016 x øDc
	High carbon steels Alloy steels	200 - 300	262 - 591	0.001 - 0.003	0.002 - 0.003	0.002 - 0.004	0.002 - 0.004	0.003 - 0.005	0.003 - 0.006	0.003 - 0.006	0.012 x øDc	0.016 x øDc
	Prehardened steel PX5, NAK80, etc.	30 - 40 HRC	262 - 525	0.001 - 0.003	0.002 - 0.003	0.002 - 0.004	0.002 - 0.004	0.003 - 0.005	0.003 - 0.006	0.003 - 0.006	0.012 x øDc	0.016 x øDc
M	Stainless steels 304, 316, etc.	-	197 - 328	0.001 - 0.003	0.002 - 0.003	0.002 - 0.004	0.002 - 0.004	0.003 - 0.005	0.003 - 0.006	0.003 - 0.006	0.012 x øDc	0.016 x øDc
K	Grey cast irons	150 - 250	328 - 722	0.001 - 0.003	0.002 - 0.003	0.002 - 0.004	0.002 - 0.004	0.003 - 0.005	0.003 - 0.006	0.003 - 0.006	0.012 x øDc	0.016 x øDc
	Ductile cast irons	150 - 250	328 - 722	0.001 - 0.003	0.002 - 0.003	0.002 - 0.004	0.002 - 0.004	0.003 - 0.005	0.003 - 0.006	0.003 - 0.006	0.012 x øDc	0.016 x øDc
N	Aluminum alloys (Si < 13%)	-	656 - 2297	0.001 - 0.003	0.002 - 0.003	0.002 - 0.004	0.002 - 0.004	0.003 - 0.005	0.003 - 0.006	0.003 - 0.006	0.012 x øDc	0.016 x øDc
S	High temp alloy	55HRC	131 - 262	0.001 - 0.003	0.002 - 0.003	0.002 - 0.004	0.002 - 0.004	0.003 - 0.005	0.003 - 0.006	0.003 - 0.006	0.012 x øDc	0.008 x øDc
H	High hardened steels	150 - 225	131 - 262	0.001 - 0.003	0.002 - 0.003	0.002 - 0.004	0.002 - 0.004	0.003 - 0.005	0.003 - 0.006	0.003 - 0.006	0.012 x øDc	0.008 x øDc

Standard cutting conditions: Profiling for semi-finishing and finishing (VBB-BM / BG / SG, VBD-BG, VBE-BGA)

ISO	Workpiece material	Hardness	Cutting speed Vc (sfm)	Feed per tooth: fz (ipt)							Depth of cut ap (in)	Pick feed Pf (in)
				Tool diameter: øDc (in)								
				0.250"	0.312"	0.375"	0.500"	0.625"	0.750"	1.000"		
P	Low carbon steels	- 300 HB	394 - 820	0.001 - 0.003	0.001 - 0.004	0.002 - 0.004	0.002 - 0.004	0.002 - 0.005	0.002 - 0.007	0.004 - 0.007	0.004 x øDc	0.006 x øDc
	High carbon steels Alloy steels	- 300 HB	328 - 722	0.001 - 0.003	0.001 - 0.004	0.002 - 0.004	0.002 - 0.004	0.002 - 0.005	0.002 - 0.007	0.004 - 0.007	0.004 x øDc	0.006 x øDc
	Prehardened steel	30 - 40 HRC	328 - 656	0.001 - 0.003	0.001 - 0.004	0.002 - 0.004	0.002 - 0.004	0.002 - 0.005	0.002 - 0.007	0.004 - 0.007	0.004 x øDc	0.006 x øDc
M	Stainless steels	- 200 HB	262 - 394	0.001 - 0.003	0.001 - 0.004	0.002 - 0.004	0.002 - 0.004	0.002 - 0.005	0.002 - 0.007	0.004 - 0.007	0.004 x øDc	0.006 x øDc
K	Grey cast irons	150 - 250 HB	394 - 919	0.001 - 0.003	0.001 - 0.004	0.002 - 0.004	0.002 - 0.004	0.002 - 0.005	0.002 - 0.007	0.004 - 0.007	0.004 x øDc	0.006 x øDc
	Ductile cast irons	150 - 250 HB	394 - 919	0.001 - 0.003	0.001 - 0.004	0.002 - 0.004	0.002 - 0.004	0.002 - 0.005	0.002 - 0.007	0.004 - 0.007	0.004 x øDc	0.006 x øDc
N	Aluminum alloys (Si < 13%)	-	984 - 3281	0.001 - 0.003	0.001 - 0.004	0.002 - 0.004	0.002 - 0.004	0.002 - 0.005	0.002 - 0.007	0.004 - 0.007	0.004 x øDc	0.006 x øDc
S	High temp alloys	-	164 - 328	0.001 - 0.003	0.001 - 0.004	0.002 - 0.004	0.002 - 0.004	0.002 - 0.005	0.002 - 0.007	0.004 - 0.007	0.003 x øDc	0.004 x øDc
H	High hardened steels	-	164 - 328	0.001 - 0.003	0.001 - 0.004	0.002 - 0.004	0.002 - 0.004	0.002 - 0.005	0.002 - 0.007	0.004 - 0.007	0.003 x øDc	0.004 x øDc



Ball

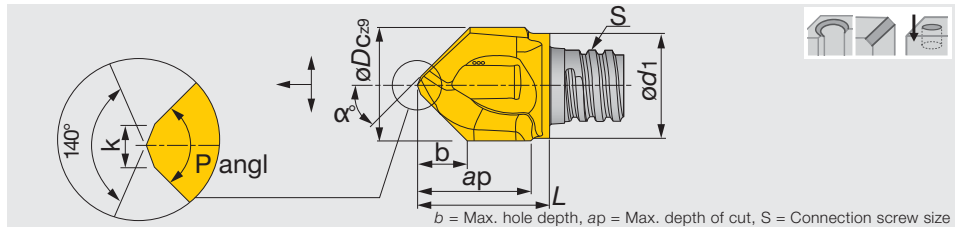

Metric	AH725	P angl	z	Helx	øDc	ød1	Max. ap	b	S	L	k	α°	Wrench	Torque*
VCP100L09.5A30-02S06	●	60°	2	0°	10	9.5	8.5	7.5	S06	11.75	1.5	30	KEYV-S06	10
VCP120L12.0A30-02S08	●	60°	2	0°	12	11.5	11	9.2	S08	15.4	1.5	30	KEYV-S08	15
VCP160L15.0A30-02S10	●	60°	2	0°	16	15.2	16	12	S10	20.2	2.5	30	KEYV-S10	28
VCP080L07.7A45-02S05	●	90°	2	0°	8	7.6	7.5	3.7	S05	9.75	1	45	KEYV-S05	7
VCP083L07.9A45-02S05	●	90°	2	0°	8.3	7.6	7.5	3.8	S05	10	1	45	KEYV-S05	7
VCP100L09.0A45-02S06	●	90°	2	0°	10	9.5	9.5	4.4	S06	11.75	1.5	45	KEYV-S06	10
VCP104L09.0A45-02S06	●	90°	2	0°	10.4	9.5	9.5	4.6	S06	11.75	1.5	45	KEYV-S06	10
VCP120L12.0A45-02S08	●	90°	2	0°	12	11.5	11.5	5.4	S08	15.4	1.5	45	KEYV-S08	15
VCP124L12.0A45-02S08	●	90°	2	0°	12.4	11.5	11.5	5.6	S08	15.4	1.5	45	KEYV-S08	15
VCP160L15.0A45-02S10	●	90°	2	0°	16	15.2	15	7.1	S10	18.8	1.5	45	KEYV-S10	28
VCP165L15.0A45-02S10	●	90°	2	0°	16.5	15.2	15	7.1	S10	18.8	1.5	45	KEYV-S10	28
VCP100L09.5A60-02S06	●	120°	2	0°	10	9.5	9.5	2.7	S06	12.7	1.5	60	KEYV-S06	10
VCP120L12.0A60-02S08	●	120°	2	0°	12	11.5	11.5	3.3	S08	15.2	1.5	60	KEYV-S08	15
VCP160L15.5A60-02S10	●	120°	2	0°	16	15.2	16	4.4	S10	19.9	1.5	60	KEYV-S10	28

● Min. chamfering: ø1.5 mm

*Torque: Recommended torque (N·m) for clamping.

Packing quantity = 2 pcs.

●: Line up

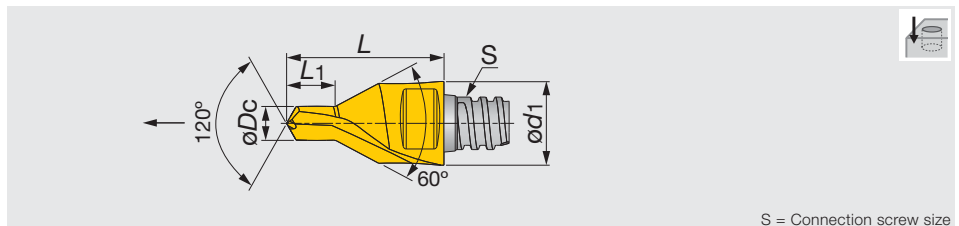

Metric	AH725	z	Helx	øDc	ød1	L1	S	L	Wrench	Torque*
VDP328L04.6A30-02S05	●	2	0°	3.28	8	4.6	S05	15	KEYV-S05	7
VDP412L05.9A30-02S06	●	2	0°	4.12	10	5.9	S06	19	KEYV-S06	10
VDP513L07.2A30-02S08	●	2	0°	5.13	12	7.2	S08	23	KEYV-S08	15
VDP646L08.9A30-02S10	●	2	0°	6.46	16	8.9	S10	28	KEYV-S10	28

*Torque: Recommended torque (N·m) for clamping.

Packing quantity = 2 pcs.

●: Line up

Reference pages

Standard cutting conditions → **D186**



Multi Function



Ball



Multi Function

STANDARD CUTTING CONDITIONS

Drilling (VCP, VDP)

ISO	Workpiece material	Hardness	Cutting speed Vc (sfm)	Feed: <i>f</i> (ipr)				
				VDP328	VDP412	VDP513	VDP646	VCP
P	Low carbon steels 1045, 1055, etc.	- 300 HB	131 - 262	0.0016 - 0.0031	0.0020 - 0.0039	0.0020 - 0.0039	0.0024 - 0.0047	0.0024 - 0.0047
	High carbon steels 4140, etc.	- 300 HB	98 - 164	0.0016 - 0.0031	0.0020 - 0.0039	0.0020 - 0.0039	0.0024 - 0.0047	0.0024 - 0.0047
	Prehardened steel PX5, NAK80, etc.	30 - 40 HRC	66 - 98	0.0016 - 0.0031	0.0020 - 0.0039	0.0020 - 0.0039	0.0024 - 0.0047	0.0024 - 0.0047
M	Stainless steels 304, 316, etc.	- 200 HB	49 - 82	0.0016 - 0.0031	0.0020 - 0.0039	0.0020 - 0.0039	0.0024 - 0.0047	0.0024 - 0.0047
K	Grey cast irons 250, 300, etc.	150 - 250 HB	197 - 328	0.0020 - 0.0035	0.0028 - 0.0047	0.0028 - 0.0047	0.0047 - 0.0071	0.0047 - 0.0071
	Ductile cast irons 400-15S, etc.	150 - 250 HB	197 - 328	0.0016 - 0.0031	0.0020 - 0.0039	0.0020 - 0.0039	0.0039 - 0.0059	0.0039 - 0.0059
S	Titanium alloys Ti-6Al-4V, etc.	-	49 - 82	0.0016 - 0.0028	0.0016 - 0.0028	0.0016 - 0.0028	0.0016 - 0.0028	0.0016 - 0.0028
	Heat-resistant alloys Inconel 718, etc.	-	328 - 66	0.0012 - 0.0024	0.0012 - 0.0024	0.0012 - 0.0024	0.0012 - 0.0024	0.0012 - 0.0024
H	Hardened steel	SKD61, SKT4, etc. H13, etc.	40 - 50 HRC	49 - 82	0.0016 - 0.0028	0.0016 - 0.0028	0.0016 - 0.0028	0.0016 - 0.0028
		SKD11, SKH, etc. D2, etc.	50 - 60 HRC	328 - 66	0.0012 - 0.0024	0.0012 - 0.0024	0.0012 - 0.0024	0.0012 - 0.0024



Chamfering

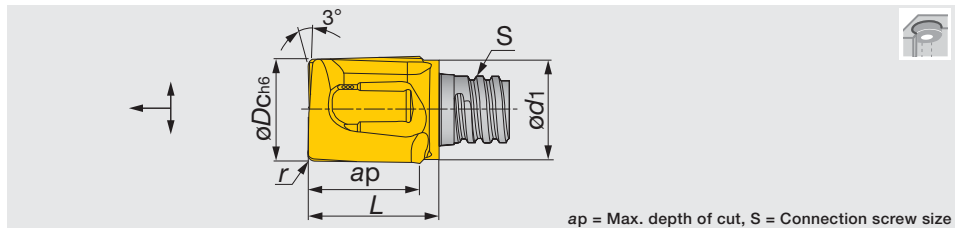

ap = Max. depth of cut, S = Connection screw size

Inch	AH725	z	Helix	$\varnothing D_c$	$\varnothing d_1$	Max. ap	r	S	L	Wrench	Torque*
VGC031L31R016-U02S05	●	2	10°	0.312	0.297	0.310	0.016	S05	0.390	KEYV-S05	5.16
VGC037L38R016-U02S06	●	2	10°	0.375	0.360	0.380	0.016	S06	0.485	KEYV-S05	7.38
VGC050L55R016-U02S08	●	2	10°	0.500	0.453	0.433	0.016	S08	0.598	KEYV-S05	11.06
VGC056L43R016-U02S08	●	2	10°	0.562	0.450	0.460	0.016	S08	0.590	KEYV-S05	11.06
VGC062L63R016-U02S10	●	2	10°	0.625	0.600	0.600	0.016	S10	0.750	KEYV-S06	20.65
VGC062L63R032-U02S10	●	2	10°	0.625	0.600	0.600	0.032	S10	0.750	KEYV-S06	20.65

• Can drill with step feed

*Torque: Recommended torque (lbf-ft) for clamping.

Packing quantity = 2 pcs.

STANDARD CUTTING CONDITIONS

Counter boring (VGC)

ISO	Workpiece material	Hardness	Cutting speed Vc (sfm)	Feed f (ipr)
P	Low carbon steels 1045, 1055, etc.	- 300 HB	131 - 262	0.002 - 0.002
	High carbon steels 4140, etc.	- 300 HB	98 - 164	0.002 - 0.003
	Prehardened steel PX5, NAK80 etc	30 - 40 HRC	66 - 98	0.002 - 0.003
M	Stainless steels 304, 316, etc.	- 200 HB	49 - 82	0.002 - 0.003
K	Grey cast irons 250, 300, etc.	150 - 250 HB	197 - 328	0.002 - 0.09
	Ductile cast irons 400-15S, etc.	150 - 250 HB	197 - 328	0.002 - 0.003
S	Titanium alloys Ti-6Al-4V etc	-	49 - 82	0.002 - 0.003
	Heat-resistant alloys Inconel 718 etc	-	33 - 66	0.001 - 0.06
H	Hardened steel	SKD61, SKT4 etc H13, etc.	49 - 82	0.002 - 0.003
		SKD11, SKH etc D2, etc.	50 - 60 HRC	33 - 66

• When drilling, the step feed (woodpecker feed) operation should be applied with the depth of 0.011" - 0.019" per step.

• Apply the same cutting conditions as the VEE type head when conducting shoulder milling or slotting operations.





Multi Function

TUNGMEISTER

VCA**-04,06...

TungMeister head with 4 or 6 flutes for countersinking and chamfering

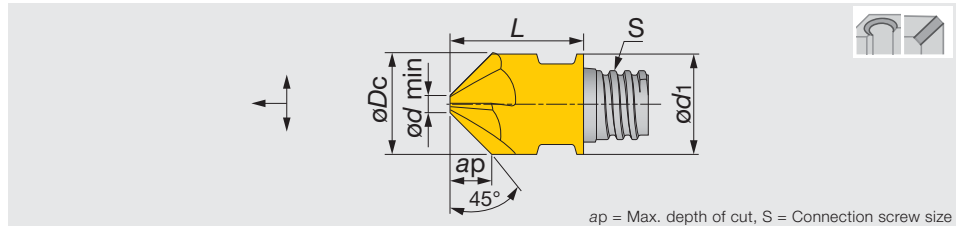

Inch	AH725	z	Helx	øDc	ød1	Max. ap	ød min	S	L	Wrench	Torque**
VCA0375L16A45-U04S06	●	4	0°	0.375	0.375	0.150	0.073	S06	0.512	KEYV-S06	7.38

Metric	AH725	z	Helx	øDc	ød1	Max. ap	ød min	S	L	Wrench	Torque**
VCA100L04.0A45-04S06	●	4	0°	10	10	4	1.95	S06	13	KEYV-S06	10
VCA120L05.0A45-04S08	●	4	0°	12	12	5	1.95	S08	16.5	KEYV-S08	15
VCA127L05.3A45-04S08	●	4	0°	12.7	12.7	5.3	1.98	S08	16.5	KEYV-S08	15
VCA160L06.5A45-06S10	●	6	0°	16	16	6.5	3	S10	20.3	KEYV-S10	28
VCA200L07.5A45-06S12	●	6	0°	20	18.3	7.5	5	S12	25.5	KEYV-S12	28

**Torque: Recommended torque (lb-ft, N-m) for clamping.
Packing quantity = 2 pcs.

●: Line up

TUNGMEISTER

VCW**-02...

TungMeister head for countersinking, top and bottom chamfering

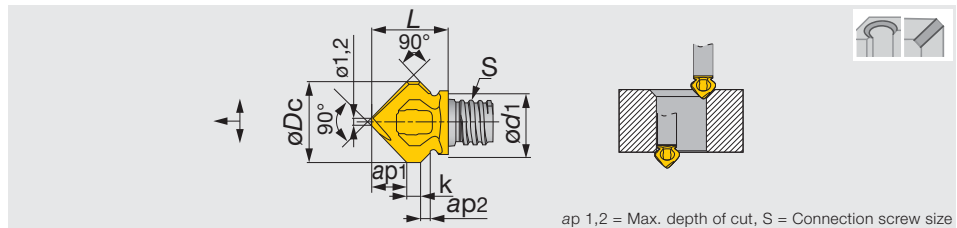

Metric	AH725	z	Helx	øDc	ød1	ap1	ap2	k	S	L	Wrench	Torque**
VCW118L05.0A45-02S06	●	2	0°	11.8	9.3	5	1.2	2	S06	11.2	KEYV-S08	10

• Available for chamfering of reverse side
* Some heads require different wrench size.
**Torque: Recommended torque (N-m) for clamping.
Packing quantity = 2 pcs.

●: Line up



Chamfering

Reference pages

Standard cutting conditions → **D189**

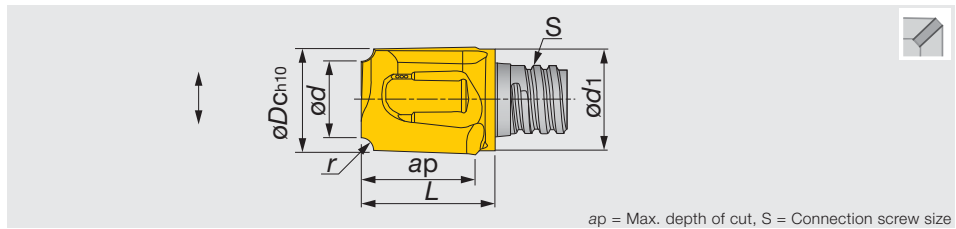

ap = Max. depth of cut, S = Connection screw size

Metric	AH725	z	Helx	$\varnothing D_c$	$\varnothing d_1$	$\varnothing d$	Max. ap	r	S	L	Wrench	Torque**
VCR080L07.5R10-02S05	●	2	0°	8	7.6	5.8	7.5	1	S05	10.5	KEYV-S05	7
VCR100L09.5R16-02S06	●	2	0°	10	9.5	6.8	9.5	1.6	S06	12.5	KEYV-S06	10
VCR100L09.5R25-02S06	●	2	0°	10	9.5	5.1	9.5	2.5	S06	12.5	KEYV-S06	10
VCR127L12.0R30-02S08	●	2	0°	12.7	12.2	6.5	12.0	3	S08	15.6	KEYV-S08	15
VCR127L12.0R40-02S08	●	2	0°	12.7	12.2	4.7	12.0	4	S08	15.6	KEYV-S08	15
VCR160L15.0R50-02S10	●	2	0°	16	15.2	6.2	15.0	5	S10	19.1	KEYV-S10	28
VCR200L07.0R60-02S12	●	2	0°	20	18.3	8	7.0	6	S12	17.4	KEYV-S12	28

**Torque: Recommended torque (N·m) for clamping.
Packing quantity = 2 pcs.

●: Line up

STANDARD CUTTING CONDITIONS

Chamfering and countersinking (VCA, VCW, VCR, VCP)

ISO	Workpiece material	Hardness	Cutting speed Vc (sfm)	Feed f (ipr)
P	Low carbon steels 1045, 1055, etc.	- 300 HB	197 - 328	0.0024 - 0.0047
	High carbon steels 4140, etc.	- 300 HB	164 - 262	0.0024 - 0.0047
	Prehardened steel PX5, NAK80 etc	30 - 40 HRC	131 - 230	0.0024 - 0.0047
M	Stainless steels SUS304, SUS316, etc. 304, 316, etc.	- 200 HB	98 - 164	0.0024 - 0.0047
K	Grey cast irons 250, 300, etc.	150 - 250 HB	262 - 394	0.0024 - 0.0047
	Ductile cast irons 400-15S, etc.	150 - 250 HB	262 - 394	0.0024 - 0.0047
N	Aluminum alloys	-	328 - 656	0.0031 - 0.0059
S	Titanium alloys Ti-6Al-4V, etc.	-	98 - 164	0.0020 - 0.0039
	Heat-resistant alloys Inconel 718, etc.	-	66 - 131	0.0016 - 0.0031
H	SKD61, SKT4 etc SKD61, SKT4 etc. SKD11, SKH etc D2, etc.	40 - 50 HRC	98 - 164	0.0020 - 0.0039
		50 - 60 HRC	66 - 131	0.0016 - 0.0031



Multi Function



Chamfering

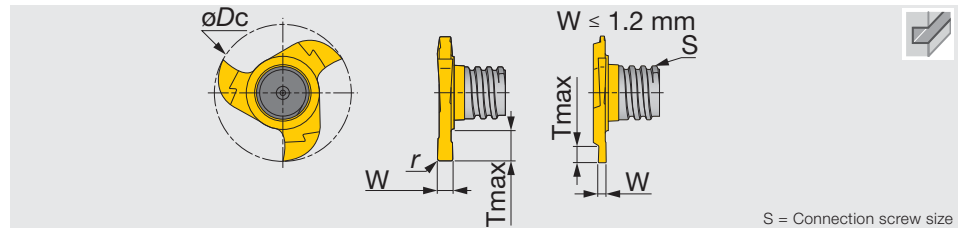

S = Connection screw size

Metric	GH130	z	Helx	$\varnothing D_c$	$W^{+0.02}$	r	S	T max	Wrench	Torque*
VST157W1.50R010-3S06	●	3	0°	15.7	1.5	0.1	S06	2.8	KEYV-177	10
VST157W1.57R020-3S06	●	3	0°	15.7	1.57	0.2	S06	2.8	KEYV-177	10
VST157W2.00R020-3S06	●	3	0°	15.7	2	0.2	S06	2.8	KEYV-177	10
VST157W2.39R020-3S06	●	3	0°	15.7	2.39	0.2	S06	2.8	KEYV-177	10
VST157W2.50R020-3S06	●	3	0°	15.7	2.5	0.2	S06	2.8	KEYV-177	10
VST157W3.00R020-3S06	●	3	0°	15.7	3	0.2	S06	2.8	KEYV-177	10
VST157W3.17R020-3S06	●	3	0°	15.7	3.17	0.2	S06	2.8	KEYV-177	10
VST177W1.20R005-3S06	●	3	0°	17.7	1.2 ⁽¹⁾	0.05	S06	3.8	KEYV-177	10
VST177W1.40R005-3S06	●	3	0°	17.7	1.4 ⁽¹⁾	0.05	S06	3.8	KEYV-177	10
VST177W1.50R010-3S06	●	3	0°	17.7	1.5	0.1	S06	3.8	KEYV-177	10
VST177W1.57R020-3S06	●	3	0°	17.7	1.57	0.2	S06	3.8	KEYV-177	10
VST177W1.70R005-3S06	●	3	0°	17.7	1.7 ⁽¹⁾	0.05	S06	3.8	KEYV-177	10
VST177W2.00R020-3S06	●	3	0°	17.7	2	0.2	S06	3.8	KEYV-177	10
VST177W2.20R110-3S06	●	3	0°	17.7	2.2	1.1	S06	3.8	KEYV-177	10
VST177W2.39R020-3S06	●	3	0°	17.7	2.39	0.2	S06	3.8	KEYV-177	10
VST177W2.50R020-3S06	●	3	0°	17.7	2.5	0.2	S06	3.8	KEYV-177	10
VST177W3.00R020-3S06	●	3	0°	17.7	3	0.2	S06	3.8	KEYV-177	10
VST177W3.17R020-3S06	●	3	0°	17.7	3.17	0.2	S06	3.8	KEYV-177	10

(1) W is based on DIN471 / 472

*Torque: Recommended torque (N·m) for clamping.

Packing quantity = 2 pcs.

●: Line up



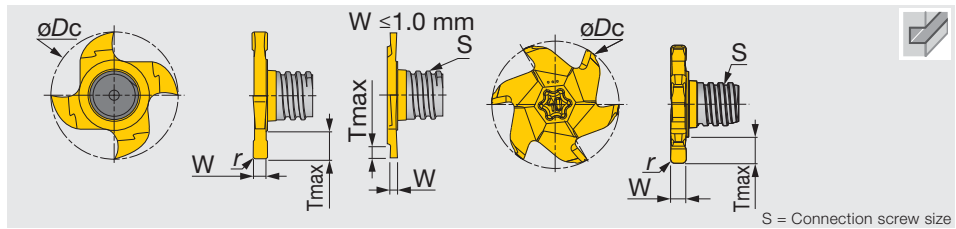

Metric	GH130	Helix	z	ϕD_c	$W^{0.02}$	r	S	T max	Wrench	Torque*
VST217W0.76R000-4S08	●	0°	4	21.7	0.76 ⁽¹⁾	-	S08		KEYV-217	15
VST217W0.86R000-4S08	●	0°	4	21.7	0.86 ⁽¹⁾	-	S08	1.7	KEYV-217	15
VST217W0.96R000-4S08	●	0°	4	21.7	0.96 ⁽¹⁾	-	S08	1.9	KEYV-217	15
VST217W1.00R005-4S08	●	0°	4	21.7	1	0.05	S08	2	KEYV-217	15
VST217W1.20R005-4S08	●	0°	4	21.7	1.2 ⁽¹⁾	0.05	S08	4.5	KEYV-217	15
VST217W1.40R005-4S08	●	0°	4	21.7	1.4 ⁽¹⁾	0.05	S08	4.5	KEYV-217	15
VST217W1.57R000-4S08	●	0°	4	21.7	1.57	-	S08	4.5	KEYV-217	15
VST217W1.70R010-4S08	●	0°	4	21.7	1.7 ⁽¹⁾	0.1	S08	4.5	KEYV-217	15
VST217W1.95R020-4S08	●	0°	4	21.7	1.95 ⁽¹⁾	0.2	S08	4.5	KEYV-217	15
VST217W2.00R020-4S08	●	0°	4	21.7	2	0.2	S08	4.5	KEYV-217	15
VST217W2.25R020-4S08	●	0°	4	21.7	2.25 ⁽¹⁾	0.2	S08	4.5	KEYV-217	15
VST217W2.39R020-4S08	●	0°	4	21.7	2.39	0.2	S08	4.5	KEYV-217	15
VST217W2.50R020-4S08	●	0°	4	21.7	2.5	0.2	S08	4.5	KEYV-217	15
VST217W2.75R020-4S08	●	0°	4	21.7	2.75 ⁽¹⁾	0.2	S08	4.5	KEYV-217	15
VST217W3.00R020-4S08	●	0°	4	21.7	3	0.2	S08	4.5	KEYV-217	15
VST217W3.17R020-4S08	●	0°	4	21.7	3.17	0.2	S08	4.5	KEYV-217	15
VST217W3.25R020-4S08	●	0°	4	21.7	3.25 ⁽¹⁾	0.2	S08	4.5	KEYV-217	15
VST217W4.00R020-4S08	●	0°	4	21.7	4	0.2	S08	4.5	KEYV-217	15
VST217W4.25R020-4S08	●	0°	4	21.7	4.25 ⁽¹⁾	0.2	S08	4.5	KEYV-217	15
VST217W4.75R020-4S08	●	0°	4	21.7	4.75	0.2	S08	4.5	KEYV-217	15
VST217W5.25R020-4S08	●	0°	4	21.7	5.25 ⁽¹⁾	0.2	S08	4.5	KEYV-217	15
VST277W2.50R020-6S10	●	0°	6	27.7	2.5	0.2	S10	6	KEYV-T40L	28
VST277W5.25R020-6S10	●	0°	6	27.7	5.25	0.2	S10	6	KEYV-T40L	28
VST277W10.0R020-6S10	●	0°	6	27.7	10	0.2	S10	6	KEYV-T40L	28

(1) W is based on DIN471 / 472

*Torque: Recommended torque (N-m) for clamping.

Packing quantity = 2 pcs.

●: Line up

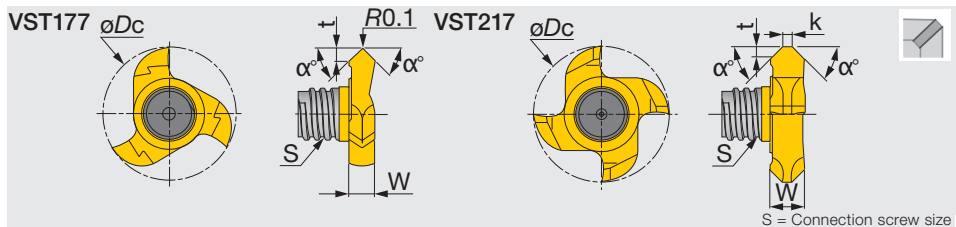

Metric	GH130	z	Helix	ϕD_c	W	α°	S	t	k	Wrench	Torque*
VST177L01.40A45-3S06	●	3	0°	17.7	3.4	45	S06	1.4	-	KEYV-177	10
VST217L01.70A45-4S08	●	4	0°	21.7	5.5	45	S08	1.7	1.5	KEYV-217	15

*Torque: Recommended torque (N-m) for clamping.

Packing quantity = 2 pcs.

●: Line up

Reference pages

Standard cutting conditions → D193





Multi Function

TUNGMEISTER

VTB**-06...

TungMeister head for T-slotting of 0.125" - 0.312" width

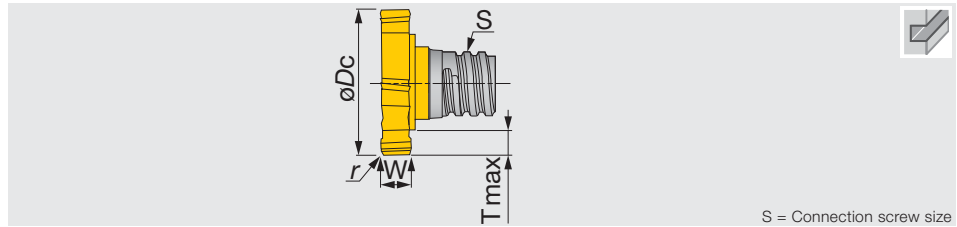

S = Connection screw size

Inch	GH130	z	Helx	$\varnothing Dc - \frac{0}{0.002}$ "	$W \pm 0.0008$ "	T max	S	r	Wrench	Torque*
VTB05W125R016-U06S05	●	6	0°	0.500	0.125	0.088	S05	0.016	KEYV-T20	5.16
VTB06W056R016-U06S06	●	6	0°	0.625	0.056	0.125	S06	0.016	KEYV-T20	7.38
VTB06W063R016-U06S06	●	6	0°	0.625	0.063	0.125	S06	0.016	KEYV-T20	7.38
VTB06W068R016-U06S06	●	6	0°	0.625	0.068	0.125	S06	0.016	KEYV-T20	7.38
VTB06W078R016-U06S06	●	6	0°	0.625	0.078	0.125	S06	0.016	KEYV-T20	7.38
VTB06W086R016-U06S06	●	6	0°	0.625	0.086	0.125	S06	0.016	KEYV-T25	7.38
VTB06W105R016-U06S06	●	6	0°	0.625	0.105	0.125	S06	0.016	KEYV-T25	7.38
VTB06W125R016-U06S06	●	6	0°	0.625	0.125	0.125	S06	0.016	KEYV-T25	7.38
VTB06W156R016-U06S06	●	6	0°	0.625	0.156	0.125	S06	0.016	KEYV-T25	7.38
VTB07W156R016-U06S08	●	6	0°	0.750	0.156	0.120	S08	0.016	KEYV-T30L	11.06
VTB07W187R016-U06S08	●	6	0°	0.750	0.187	0.120	S08	0.016	KEYV-T30L	11.06
VTB07W250R016-U06S08	●	6	0°	0.750	0.250	0.120	S08	0.016	KEYV-T30L	11.06
VTB08W187R016-U06S08	●	6	0°	0.875	0.187	0.190	S08	0.016	KEYV-T40L	11.06
VTB08W250R016-U06S08	●	6	0°	0.875	0.250	0.190	S08	0.016	KEYV-T40L	11.06
VTB08W312R016-U06S08	●	6	0°	0.875	0.312	0.190	S08	0.016	KEYV-T40L	11.06
VTB10W187R016-U06S10	●	6	0°	1.000	0.187	0.177	S10	0.016	KEYV-T50L	20.65
VTB10W250R016-U06S10	●	6	0°	1.000	0.250	0.177	S10	0.016	KEYV-T50L	20.65

*Torque: Recommended torque (lbf-ft) for clamping.
Packing quantity = 2 pcs.

●: Line up

TUNGMEISTER

VTB**C006...

TungMeister head for T-slotting of 0.062" - 0.078" width with chamfered edges

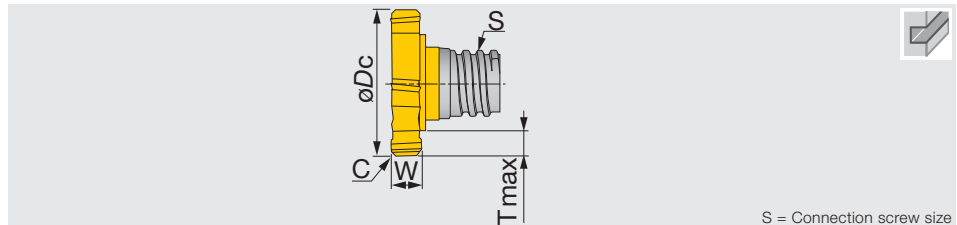

S = Connection screw size

Inch	GH130	z	Helx	$\varnothing Dc - \frac{0}{0.002}$ "	$W \pm 0.002$ "	T max	S	C	Wrench	Torque*
VTB05W062C006-U06S05	●	6	0°	0.500	0.062	0.089	S05	0.006	KEYV-T20	5.16
VTB05W078C006-U06S05	●	6	0°	0.500	0.078	0.089	S05	0.006	KEYV-T20	5.16

*Torque: Recommended torque (lbf-ft) for clamping.
Packing quantity = 2 pcs.

●: Line up



Slotting

Reference pages

Standard cutting conditions → **D193**

STANDARD CUTTING CONDITIONS

Slotting (VST, VTB)

ISO	Workpiece material	Hardness HB	VST type		VTB type	
			Cutting speed Vc (sfm)	Feed per tooth fz (ipt)	Cutting speed Vc (sfm)	Feed per tooth fz (ipt)
P	Low carbon steels 1045, 1055, etc.	- 300	262 - 591	0.002 - 0.006	262 - 591	0.003 - 0.007
	High carbon steels 4140, etc.	- 300	197 - 394	0.002 - 0.005	197 - 394	0.002 - 0.006
M	Stainless steels 304, 316, etc.	- 200	164 - 394	0.002 - 0.005	164 - 394	0.002 - 0.006
K	Grey cast irons 250, 300, etc.	150 - 250	328 - 656	0.002 - 0.006	328 - 656	0.003 - 0.007
	Ductile cast irons 400-15S, etc.	150 - 250	328 - 656	0.002 - 0.005	328 - 656	0.002 - 0.006
N	Aluminum alloys Si < 13%	-	656 - 1969	0.002 - 0.006	656 - 1969	0.003 - 0.007
	Aluminum alloys Si ≥ 13%	-	328 - 984	0.001 - 0.005	328 - 984	0.002 - 0.006
S	Titanium alloys Ti-6Al-4V, etc.	-	131 - 197	0.002 - 0.002	131 - 197	0.002 - 0.006
	Heat-resistant alloys Inconel 718, etc.	-	49 - 115	0.001 - 0.004	49 - 115	0.001 - 0.004



Multi Function



Slotting



Multi Function

TUNGMEISTER

VSS...

TungMeister, straight neck and cylindrical shank

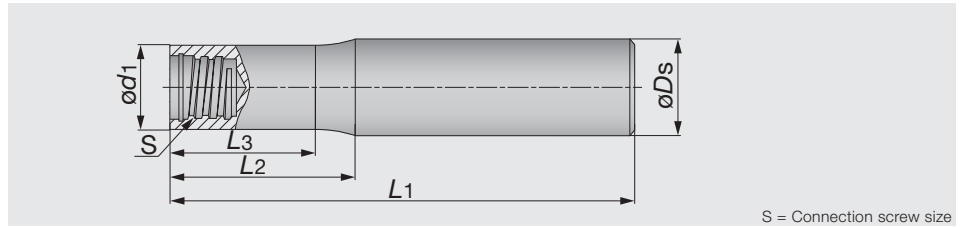

S = Connection screw size

Inch	ϕD_s	ϕd_1	L1	L2	L3	S	Type	Material
VSS031L250S05US	0.312	0.300	2.500	0.590	0.510	S05	CYLINDRICAL	STEEL
VSS037L300S06US	0.375	0.364	3.000	0.590	0.510	S06	CYLINDRICAL	STEEL
VSS050L350S08US	0.500	0.480	3.540	0.630	0.530	S08	CYLINDRICAL	STEEL
VSS062L400S10US	0.625	0.598	4.000	0.780	0.680	S10	CYLINDRICAL	STEEL
VSS075L500S12US	0.750	0.720	5.000	1.000	0.880	S12	CYLINDRICAL	STEEL
VSS031L300S05UC	0.312	0.300	3.000	1.000	0.950	S05	CYLINDRICAL	CARBIDE
VSS031L350S05UC	0.312	0.300	3.500	1.500	1.450	S05	CYLINDRICAL	CARBIDE
VSS031L400S05UC	0.312	0.300	4.000	2.000	1.950	S05	CYLINDRICAL	CARBIDE
VSS037L400S06UC	0.375	0.364	4.000	1.250	1.200	S06	CYLINDRICAL	CARBIDE
VSS037L475S06UC	0.375	0.364	4.750	2.000	1.950	S06	CYLINDRICAL	CARBIDE
VSS050L400S08UC	0.500	0.480	4.000	1.500	1.400	S08	CYLINDRICAL	CARBIDE
VSS050L550S08UC	0.500	0.480	5.500	2.500	2.450	S08	CYLINDRICAL	CARBIDE
VSS062L325S10UC	0.625	0.600	3.250	1.250	1.180	S10	CYLINDRICAL	CARBIDE
VSS062L450S10UC	0.625	0.600	4.500	2.500	2.430	S10	CYLINDRICAL	CARBIDE
VSS062L550S10UC	0.625	0.600	5.500	3.500	3.430	S10	CYLINDRICAL	CARBIDE
VSS062L700S10UC	0.625	0.600	7.000	5.000	4.930	S10	CYLINDRICAL	CARBIDE
VSS075L400S12UC	0.750	0.720	4.000	1.500	1.430	S12	CYLINDRICAL	CARBIDE
VSS075L550S12UC	0.750	0.720	5.500	3.000	2.930	S12	CYLINDRICAL	CARBIDE
VSS075L800S12UC	0.750	0.720	8.000	4.500	4.430	S12	CYLINDRICAL	CARBIDE
VSS031L300S05UW	0.312	0.299	3.000	1.000	0.978	S05	CYLINDRICAL	TUNGSTEN
VSS031L450S05UW	0.312	0.299	4.500	2.000	1.978	S05	CYLINDRICAL	TUNGSTEN
VSS037L355S06UW	0.375	0.364	3.550	0.750	0.680	S06	CYLINDRICAL	TUNGSTEN
VSS050L425S08UW	0.500	0.480	4.250	0.630	0.530	S08	CYLINDRICAL	TUNGSTEN
VSS050L218W05US	0.500	0.299	2.185	0.150	-	S05	WELDON	STEEL
VSS062L258W06US	0.625	0.366	2.580	0.236	-	S06	WELDON	STEEL
VSS062L258W08US	0.625	0.480	2.580	0.157	-	S08	WELDON	STEEL
VSS075L275W10US	0.750	0.598	2.750	0.157	-	S10	WELDON	STEEL
VSS100L300W12US	1.000	0.720	3.000	0.283	-	S12	WELDON	STEEL
VSS100L537S15US	1.000	0.957	5.375	1.375	1.313	S15	CYLINDRICAL	STEEL
VSS100L475S15UC	1.000	0.957	4.750	2.375	2.313	S15	CYLINDRICAL	CARBIDE
VSS100L675S15UC	1.000	0.957	6.750	4.000	3.938	S15	CYLINDRICAL	CARBIDE
VSS100L1000S15UC	1.000	0.957	10.000	6.000	5.938	S15	CYLINDRICAL	CARBIDE



Square



Radius



Ball



Chamfering

TUNGMEISTER

VSSD**W...

TungMeister, straight neck and weldon shank

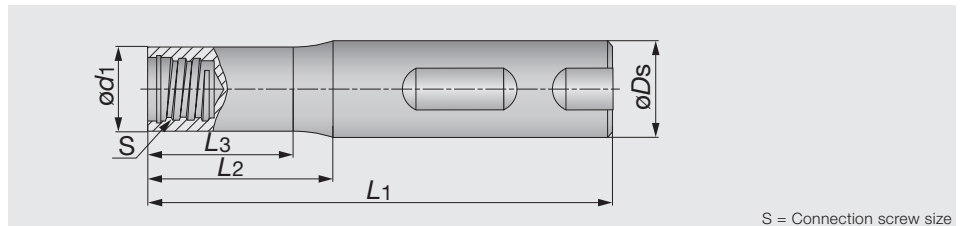

S = Connection screw size

Metric	ϕD_s	ϕd_1	L1	L2	L3	S	Shank	Material
VSSD12L055W05-S	12	7.6	55	3.8	-	S05	WELDON	STEEL
VSSD16L065W06-S	16	9.6	65	6	-	S06	WELDON	STEEL
VSSD16L065W08-S	16	11.5	65	4	-	S08	WELDON	STEEL
VSSD20L070W10-S	20	15.2	70	4	-	S10	WELDON	STEEL
VSSD25L075W12-S	25	18.3	75	6	-	S12	WELDON	STEEL

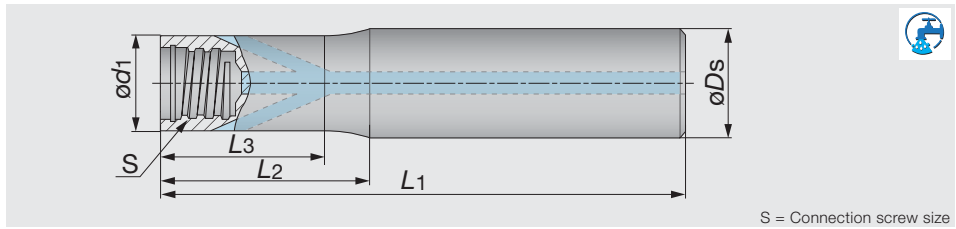

S = Connection screw size

Metric	$\varnothing D_s$	$\varnothing d_1$	L_1	L_2	L_3	S	Material
VSSD10L070S06-W-A	10	9.6	70	20	19	S06	TUNGSTEN
VSSD10L090S06-W-A	10	9.6	90	40	39	S06	TUNGSTEN
VSSD10L110S06-W-A	10	9.6	110	60	59	S06	TUNGSTEN
VSSD12L070S08-W-A	12	11.5	70	20	19	S08	TUNGSTEN
VSSD12L090S08-W-A	12	11.5	90	40	39	S08	TUNGSTEN
VSSD12L110S08-W-A	12	11.5	110	60	59	S08	TUNGSTEN
VSSD12L130S08-W-A	12	11.5	130	80	79	S08	TUNGSTEN
VSSD16L070S10-W-A	16	15.2	70	20	18.5	S10	TUNGSTEN
VSSD16L090S10-W-A	16	15.2	90	40	36.5	S10	TUNGSTEN
VSSD16L110S10-W-A	16	15.2	110	60	58.5	S10	TUNGSTEN
VSSD16L130S10-W-A	16	15.2	130	80	78.5	S10	TUNGSTEN
VSSD20L090S12-W-A	20	18.3	90	40	37	S12	TUNGSTEN
VSSD20L130S12-W-A	20	18.3	130	80	77	S12	TUNGSTEN



Multi Function



Square



Radius



Ball



Chamfering



Multi Function

TUNGMEISTER

VTS...

TungMeister, straight shank and taper neck

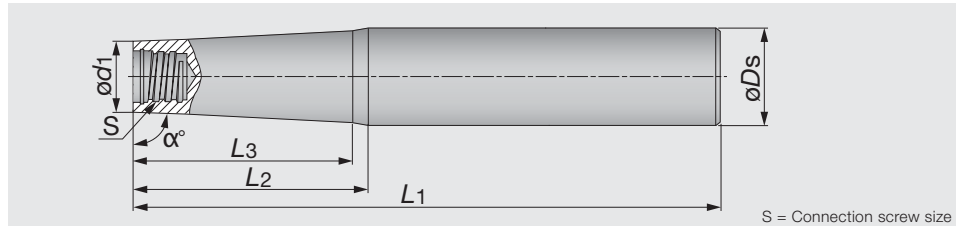

Inch	α°	ϕD_s	ϕd_1	L_1	L_2	L_3	S	Material
VTS050L300S05US	85	0.500	0.300	3.000	1.000	0.930	S05	STEEL
VTS050L400S05US	89	0.500	0.300	4.000	1.500	1.300	S05	STEEL
VTS062L500S06US	89	0.625	0.370	5.000	1.380	1.283	S06	STEEL
VTS062L630S06US	89	0.625	0.364	6.300	2.170	1.750	S06	STEEL
VTS062L550S08US	85	0.625	0.480	5.500	0.870	0.770	S08	STEEL
VTS075L650S08US	89	0.750	0.480	6.500	3.150	2.770	S08	STEEL
VTS075L550S10US	85	0.750	0.598	5.500	0.880	0.000	S10	STEEL
VTS100L670S10US	89	1.000	0.598	6.700	1.600	0.000	S10	STEEL
VTS075L750S10US	89	0.750	0.600	7.500	3.150	2.950	S10	STEEL
VTS100L630S12US	89	1.000	0.720	6.300	1.600	-	S12	STEEL
VTS125L750S12US	89	1.250	0.720	7.500	3.150	-	S12	STEEL
VTS100L800S12US	89	1.000	0.720	8.000	3.750	3.400	S12	STEEL
VTS037L350S05UC	85	0.375	0.300	3.500	1.500	0.000	S05	CARBIDE
VTS050L450S05UC	89	0.500	0.300	4.500	2.500	1.400	S05	CARBIDE
VTS062L600S05UC	89	0.625	0.300	6.000	4.000	3.900	S05	CARBIDE
VTS050L550S06UC	89	0.500	0.364	5.500	2.500	2.470	S06	CARBIDE
VTS062L650S06UC	89	0.625	0.364	6.500	3.500	3.380	S06	CARBIDE
VTS062L650S08UC	89	0.625	0.480	6.500	3.500	3.440	S08	CARBIDE
VTS075L700S08UC	89	0.750	0.480	7.000	4.000	3.900	S08	CARBIDE
VTS075L650S10UC	85	0.750	0.600	6.500	4.000	0.000	S10	CARBIDE
VTS075L880S10UC	85	0.750	0.600	8.800	6.300	6.240	S10	CARBIDE
VTS100L1000S12UC	89	1.000	0.720	10.000	5.500	-	S12	CARBIDE
VTS075L550S06UW	89	0.750	0.370	5.500	2.240	0.000	S06	TUNGSTEN
VTS062L670S06UW	89	0.625	0.364	6.700	2.180	1.770	S06	TUNGSTEN
VTS075L670S08UW	85	0.750	0.480	6.700	3.150	2.700	S08	TUNGSTEN



Square



Radius



Ball



Chamfering

TUNGMEISTER

VTSD**-W-A

TungMeister, straight shank and taper neck with coolant hole

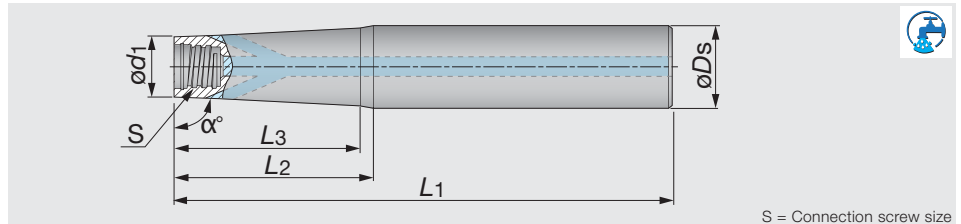

Metric	α°	ϕD_s	ϕd_1	L_1	L_2	L_3	S	Material
VTSD12L110S06-W-A	89	12	9.6	110	60	59	S06	TUNGSTEN
VTSD16L170S06-W-A	89	16	9.6	170	120	116	S06	TUNGSTEN

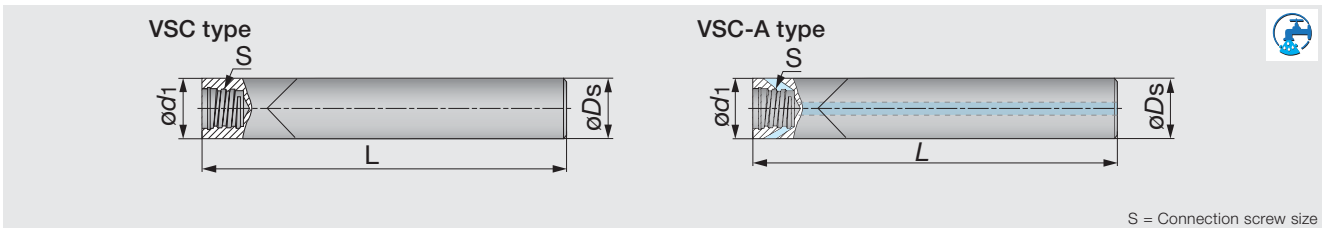

S = Connection screw size

Inch	ϕD_s	ϕd_1	L	S	Air hole	Material
VSC095L080S06-C	0.375	0.375	3.150	S06	without	CARBIDE
VSC127L120S08-C-A	0.500	0.500	4.724	S08	with	CARBIDE

Metric	ϕD_s	ϕd_1	L	S	Air hole	Material
VSC100L100S06-C	10	10	100	S06	without	CARBIDE
VSC120L100S08-C-A	12	12	100	S08	with	CARBIDE

Note: • For VSC-C type shank, just VST slotting head is recommended.
 If other heads are used on the VSC-C shank, the depth of cut must be smaller than the max. ap in each head.
 The VSC-C type shank does not have external clearance, so the shank may interfere with the work piece.

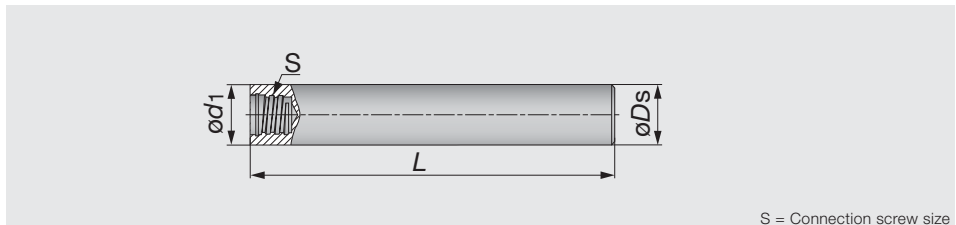

S = Connection screw size

Inch	ϕD_s	ϕd_1	L	S	Material
VST031L275S05US	0.312	0.312	2.750	S05	CARBIDE
VST037L325S06US	0.375	0.375	3.250	S06	CARBIDE
VST050L375S08US	0.500	0.500	3.750	S08	CARBIDE
VST062L400S10US	0.625	0.625	4.000	S10	CARBIDE

Metric	ϕD_s	ϕd_1	L	S	Material
VSTD08L070S05-S	8	8	70	S05	STEEL
VSTD10L080S06-S	10	10	80	S06	STEEL
VSTD12L090S08-S	12	12	90	S08	STEEL
VSTD16L100S10-S	16	16	100	S10	STEEL

Note: • For VSTD type shank, just VTB grooving head is recommended.
 If other heads are used on the VSTD shank, the depth of cut must be smaller than the max. ap in each head.
 The VSTD type shank does not have external clearance, so the shank may interfere with the work piece.





Multi Function

TUNGMEISTER TUNGFLEX

VAD**-M...

TungFlex conversion adaptor with TungMeister

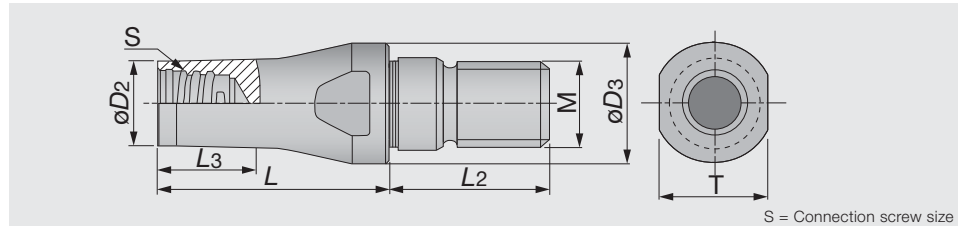

Metric	øD2	øD3	L	L2	L3	S	M	T
VAD130L016S08-S-M8	11.7	13	16	17.5	6	S08	M8	11
VAD130L025S08-S-M8	11.7	13	25	17.5	20	S08	M8	11
VAD180L020S08-S-M10	11.7	18	20	20	12	S08	M10	13
VAD180L025S08-S-M10	11.7	18	25	20	15	S08	M10	11
VAD210L020S08-S-M12	11.7	21	20	20	10	S08	M12	12.75
VAD210L025S08-S-M12	11.7	21	25	20	13	S08	M12	12.75

WRENCH

Appearance	Designation	Connection screw size	Torque (N-m)	Applicable head
	KEYV-S05	S05	7	Square Ball Radius Drilling Chamfering Counter boring
	KEYV-S06	S06	10	
	KEYV-S08	S08	15	
	KEYV-S10	S10	28	
	KEYV-S12	S12	28	
	KEYV-W20	S15	40	
	KEYV-177	S06	10	Slotting VST type
	KEYV-217	S08	15	
	KEYV-T40L	S08	15	Slotting VST, VTB type
		S10	28	
	KEYV-T20	S05	7	Slotting VTB type
		S06	10	
	KEYV-T25	S06	10	
	KEYV-T30L	S08	15	
	KEYV-T50L	S08	15	
S10		28		

Note: Optional parts

CAUTIONARY POINTS IN USE

- The cutting heads specified by Tungaloy must be used. Avoid using alternate heads that are not Tungaloy products as this will damage the shank and can cause severe accident or injury.
- Before setting the head, clean the connection screw with an air blast or a wiping cloth to remove chips and other foreign matter that may remain.
- Do not apply the lubricant to the connection screw.
- Please use the correct "Wrench" with the correct cutting head. Tighten the head slowly until the face of the head contacts the shank. (Please refer to the picture shown on the right.) Do not re-tightening or over-tightening. Excessive tightening may cause the cutting head to break.
- Do not apply excessive force or a hammer when tightening or exchanging the cutting heads.

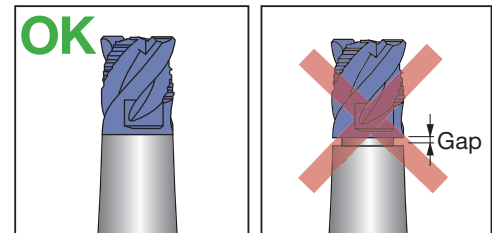

Slotting

MEMO

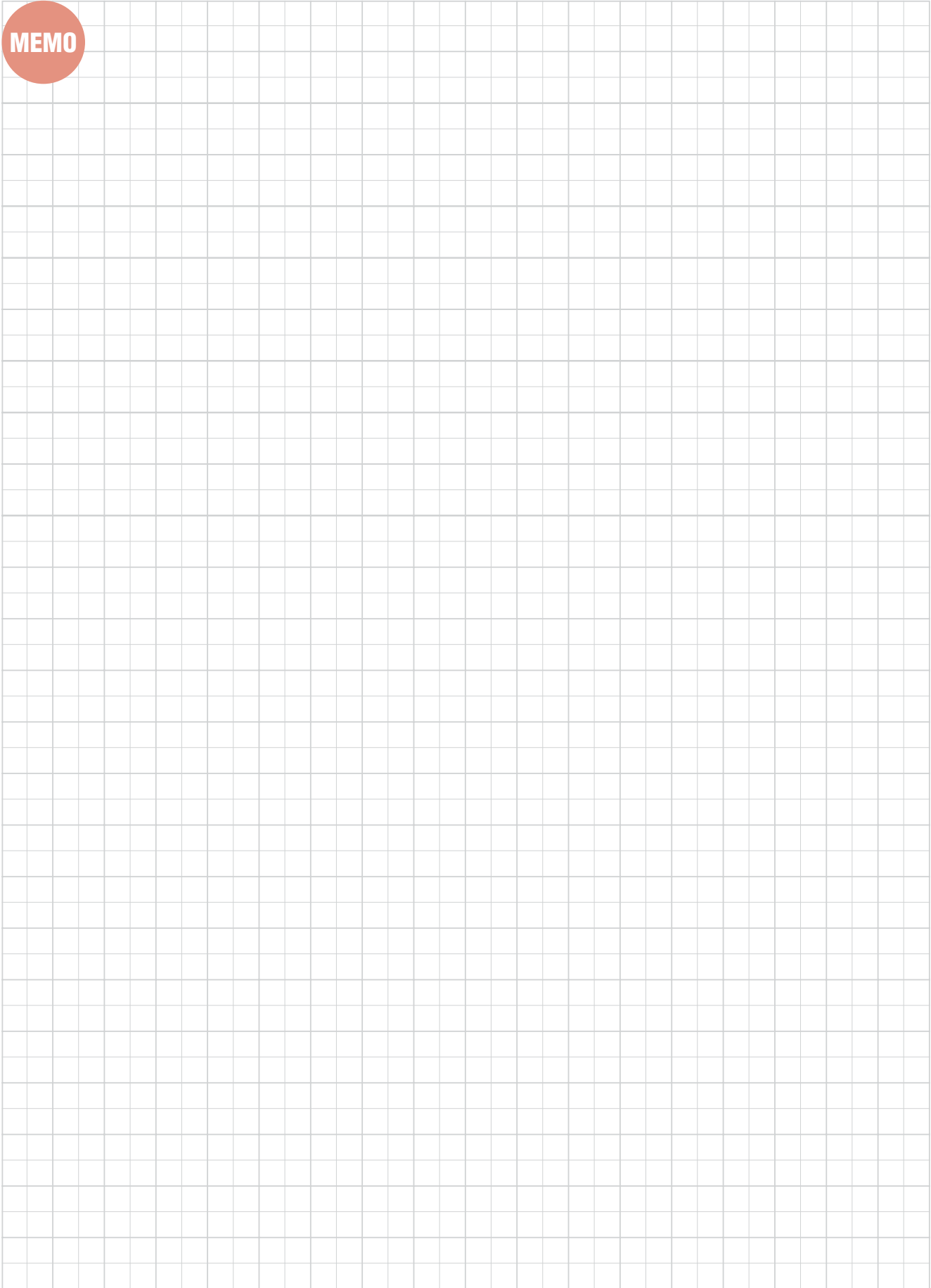

Multi Function



Multi Function

HYBRIDTACMILL EVH

Multi purpose endmills with center edge in small diameter

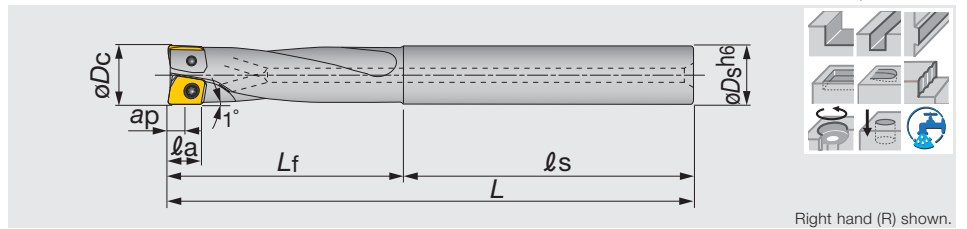

Inch	Max. ap	ϕD_c	z	ϕD_s	l_s	L_f	l_a	L	Insert
EVH06R039U0050-02	0.118	0.394	2	0.500	0.196	1.575	0.197	3.570	XVGT06H20...
EVH07R050U0050-02	0.138	0.500	2	0.500	0.236	1.890	0.236	4.000	XVGT07X30...
EVH09R063U0063-02	0.177	0.625	2	0.625	0.315	2.520	0.315	4.500	XVGT09X40...

SPARE PARTS

Designation	① Clamping screw	Lubricant	Wrench	Wrench 1
EVH06R039U0050-02	CSPD-1.8S	M-1000	-	IP-6F
EVH07R050U0050-02	CSPB-2H	M-1000	-	IP-6F
EVH09R063U0063-02	CSPB-2.5S	M-1000	IP-8D	-

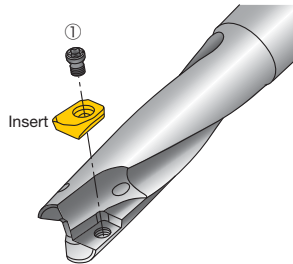

Reference pages

Inserts → **D201**, Standard cutting conditions → **D202**

INSERT

XVGT EC-MJ (Central)

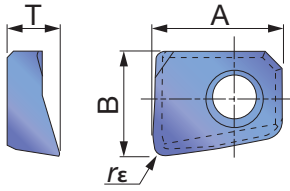

XVGT EP-MJ (Peripheral)

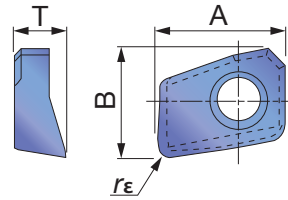

XVGT FC-AJ (Central)

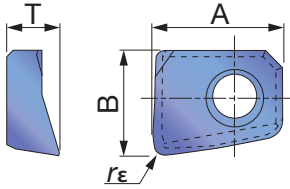

XVGT FP-AJ (Peripheral)

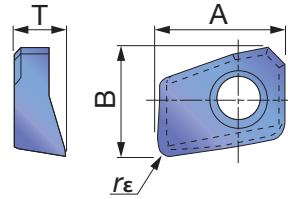

Multi Function

P Steel	★									
M Stainless	★									
K Cast iron	★									
N Non-ferrous		★								
S Superalloys										
H Hard materials										

★ : First choice
☆ : Second choice

Designation	r_ϵ	Max. ap	Coated										A	B	T		
			AH730	DS1200													
XVGT06H205EC-MJ	0.020	0.118	●												0.244	0.197	0.098
XVGT08X305EC-MJ	0.020	0.138	●												0.280	0.240	0.118
XVGT09X405EC-MJ	0.020	0.177	●												0.354	0.323	0.157
XVGT06H205EP-MJ	0.020	0.118	●												0.244	0.209	0.098
XVGT07X305EP-MJ	0.020	0.138	●												0.280	0.252	0.118
XVGT09X405EP-MJ	0.020	0.177	●												0.354	0.323	0.157
XVGT06H205FC-AJ	0.020	0.118		●											0.244	0.197	0.098
XVGT08X305FC-AJ	0.020	0.138		●											0.280	0.240	0.118
XVGT09X405FC-AJ	0.020	0.177		●											0.354	0.323	0.157
XVGT06H205FP-AJ	0.020	0.118		●											0.244	0.209	0.098
XVGT07X305FC-AJ	0.020	0.138		●											0.280	0.252	0.118
XVGT07X305FP-AJ	0.020	0.138		●											0.280	0.252	0.118
XVGT09X405FP-AJ	0.020	0.177		●											0.354	0.323	0.157

● : Line up

STANDARD CUTTING CONDITIONS

Shoulder milling, Slotting

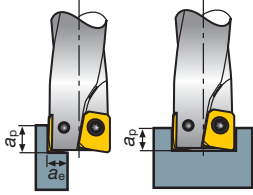

Side cutting Slotting
 a_p : Axial depth of cut
 a_e : Radial depth of cut

Workpiece material	Carbon steels and alloy steels			Alloy steels and prehardened steels			Stainless steels			Cast irons			Aluminum alloys (Si < 13%)			Aluminum alloys (Si ≥ 13%)		
	Hardness			Cutting speed			Conditions			Conditions			Conditions			Conditions		
Hardness	< 30HRC			30 - 40HRC			< 250HB			-			-			-		
Cutting speed	$V_c = 160 - 400$ SFM			$V_c = 100 - 330$ SFM			$V_c = 160 - 400$ SFM			$V_c = 200 - 140$ SFM			$V_c = 330 - 980$ SFM			$V_c = 330 - 650$ SFM		
Tool dia. (in)	No. of rev. n	Feed speed	V_f	No. of rev. n	Feed speed	V_f	No. of rev. n	Feed speed	V_f	No. of rev. n	Feed speed	V_f	No. of rev. n	Feed speed	V_f	No. of rev. n	Feed speed	V_f
	$\phi 0.394$	2550	15	1910	8	2550	15	3180	20	6370	40	4770	26					
	$\phi 0.500$	2120	13	1590	6	2120	13	2650	17	5300	33	3980	22					
Depth of cut	Side cutting			Slotting			Side cutting			Slotting			Side cutting			Slotting		
	$a_p < 0.25D$ $a_e < 0.2D$			$a_p < 0.1D$			$a_p < 0.25D$ $a_e < 0.2D$			$a_p < 0.25D$ $a_e < 0.3D$			$a_p < 0.25D$ $a_e < 0.3D$			$a_p < 0.25D$ $a_e < 0.3D$		

Drilling-Plunging

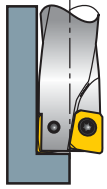

Workpiece material	Carbon steels and alloy steels			Alloy steels and prehardened steels			Stainless steels			Cast irons			Aluminum alloys (Si < 13%)			Aluminum alloys (Si ≥ 13%)		
	Hardness			Cutting speed			Conditions			Conditions			Conditions			Conditions		
Hardness	< 30HRC			30 - 40HRC			< 250HB			-			-			-		
Cutting speed	$V_c = 160 - 400$ SFM			$V_c = 100 - 330$ SFM			$V_c = 160 - 400$ SFM			$V_c = 200 - 460$ SFM			$V_c = 330 - 980$ SFM			$V_c = 330 - 980$ SFM		
Tool dia. (in)	No. of rev. n	Feed speed	V_f	No. of rev. n	Feed speed	V_f	No. of rev. n	Feed speed	V_f	No. of rev. n	Feed speed	V_f	No. of rev. n	Feed speed	V_f	No. of rev. n	Feed speed	V_f
	$\phi 0.394$	2550	5	1910	3	2550	5	3180	7	6370	18	4770	11					
	$\phi 0.500$	2120	4	1590	3	2120	4	2650	6	5300	15	3980	9					
$\phi 0.625$	1590	3	1190	2	1590	3	1990	5	3980	11	2980	7						

Note:

- In slotting or pocketing where chips tend to stay in the cutting zone, use air blast to remove chips to prevent chip recutting.
- When chips tend to weld excessively on the cutting edge such as in machining aluminum alloys, use a water soluble cutting fluid.
- In the case of cutting a casting skin or a heavily interrupted work surface, decrease the feed per tooth and the maximum depth of cut to 1/2 to 2/3 times the values shown in the table.
- Tool overhang length must be as short as possible to avoid chatter. When the tool overhang length is long, decrease the number of revolutions and feed.
- Cutting conditions are generally limited by the rigidity and power of the machine and the rigidity of the workpiece. When setting the conditions, start from half of the values of the standard cutting conditions and then increase the value gradually while making sure that the machine is running normally.

APPLICATION RANGE

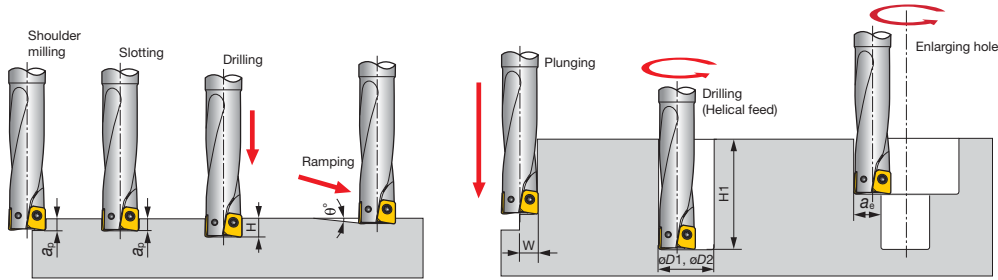

Inch	ϕD_c	Max. depth of cut a_p	Max. drilling depth H	Max. cutting width in plunging W	Max. ramping angle θ°	Min. machinable hole dia. $\phi D1$	Min. machinable hole dia. $\phi D2$	Max. cutting width in enlarging hole a_e	Max. depth of boring $H1$
	$\phi 0.394$	0.118	0.196	0.196	5	0.472	0.749	0.354	1.120
	$\phi 0.500$	0.138	0.236	0.236	5	0.551	0.906	0.433	1.420
	$\phi 0.625$	0.177	0.315	0.315	5	0.708	1.220	0.590	1.890

EVX

Multi purpose endmills with center edge in medium diameter

Standard type A.R. = +2°~ +5°, R.R. = -10°~ -3.5°
 Long type A.R. = +5°, R.R. = -4°~ -2°

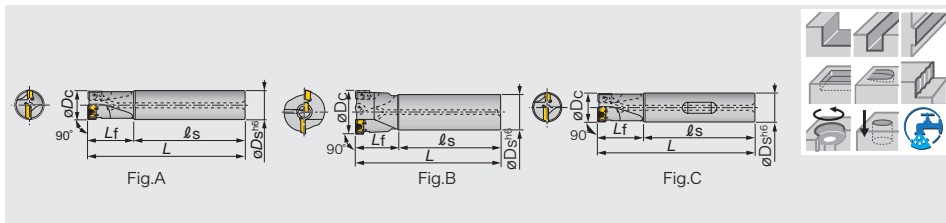

Multi Function

Inch	Max. ap	ϕD_c	z	ϕD_s	ℓ_s	L_f	L	Air hole	Fig.	Insert
EVX08062RSU	0.276	0.625	2	0.625	1.906	1.250	3.156	with	C	XXMU08...
EVX10020RSU	0.276	0.787	2	0.750	2.031	1.250	3.281	with	C	XXMU10...
EVX12100RSU	0.276	1.000	2	1.000	2.281	1.625	3.906	with	C	XXMU12...
EVX16125RSU	0.276	1.250	2	1.250	2.281	2.000	4.281	without	C	XXMU16...
EVX08062RLHU	0.276	0.625	2	0.625	5.375	1.625	7.000	with	A	XXMU08...
EVX10020RLHU	0.276	0.787	2	0.750	5.500	2.000	7.500	without	A	XXMU10...
EVX12100RLHU	0.354	1.000	2	1.000	6.000	2.750	8.750	with	A	XXMU12...
EVX16125RLHU	0.354	1.250	2	1.250	6.750	3.250	10.000	with	A	XXMU16...

Metric	Max. ap	ϕD_c	z	ϕD_s	ℓ_s	L_f	L	Air hole	Fig.	Insert
EVX08016RSA-E	7	16	2	16	55	30	85	with	C	XXMU08...
EVX08016RLA-E	7	16	2	16	55	50	105	with	C	XXMU08...
EVX08016RSA	7	16	2	16	90	30	120	with	A	XXMU08...
EVX08016RS	7	16	2	16	90	30	120	without	A	XXMU08...
EVX08016RLA	7	16	2	16	135	40	175	with	A	XXMU08...
EVX08016RL	7	16	2	16	135	40	175	without	A	XXMU08...
EVX10020RSA-E	9	20	2	20	60	30	90	with	C	XXMU10...
EVX10020RSA	9	20	2	20	90	30	120	with	A	XXMU10...
EVX10020RS	9	20	2	20	90	30	120	without	A	XXMU10...
EVX10020RLA-E	9	20	2	20	60	60	120	with	C	XXMU10...
EVX10020RLA	9	20	2	20	135	50	185	with	A	XXMU10...
EVX10020RL	9	20	2	20	135	50	185	without	A	XXMU10...
EVX12025RSA-E	11.5	25	2	25	60	40	100	with	C	XXMU12...
EVX12025RLA-E	11.5	25	2	25	60	75	135	with	C	XXMU12...
EVX12025RSA	11.5	25	2	25	100	40	140	with	A	XXMU12...
EVX12025RS	11.5	25	2	25	100	40	140	without	A	XXMU12...
EVX12025RLA	11.5	25	2	25	150	70	220	with	A	XXMU12...
EVX12025RL	11.5	25	2	25	150	70	220	without	A	XXMU16
EVX16032RSA-E	15	32	2	25	60	50	110	with	C	XXMU16...
EVX16032RLA-E	15	32	2	25	60	95	155	with	C	XXMU16...
EVX16032RSA	15	32	2	32	110	50	160	with	A	XXMU16...
EVX16032RS	15	32	2	32	110	50	160	without	A	XXMU16...
EVX16032RLA	15	32	2	32	175	80	255	with	A	XXMU16...
EVX16032RL	15	32	2	32	175	80	255	without	A	XXMU16...
EVX12040RSA	11.5	40	2	42	120	60	180	with	B	XXMU12, WCMT05...
EVX12040RS	11.5	40	2	42	120	60	180	without	B	XXMU12, WCMT05...
EVX12040RLA	11.5	40	2	42	210	100	310	with	B	XXMU12, WCMT05...
EVX12040RL	11.5	40	2	42	210	100	310	without	B	XXMU12, WCMT05...
EVX16050RSA	15	50	2	42	160	50	210	with	B	XXMU16, WCMT06...
EVX16050RS	15	50	2	42	160	50	210	without	B	XXMU16, WCMT06...
EVX16050RLA	15	50	2	42	310	50	360	with	B	XXMU16, WCMT06...
EVX16050RL	15	50	2	42	310	50	360	without	B	XXMU16, WCMT06...
EVX16063RSA	15	63	2	42	190	50	240	with	B	XXMU16, WCMT06...
EVX16063RS	15	63	2	42	190	50	240	without	B	XXMU16, WCMT06...
EVX16063RLA	15	63	2	42	310	50	360	with	B	XXMU16, WCMT06...
EVX16063RL	15	63	2	42	310	50	360	without	B	XXMU16, WCMT06...

SPARE PARTS

Designation	Clamping screw	Clamping screw 1	Lubricant	Wrench
EVX08...	-	CSPB-2.2	M-1000	IP-7D
EVX10...	-	CSPB-2.5	M-1000	IP-8D
EVX12...	-	CSPD-3	M-1000	IP-10D
EVX16...	CSPB-3.5	-	M-1000	IP-15D

Reference pages

Inserts, Standard cutting conditions → D204



Multi Function

INSERT

XXMU-MJ

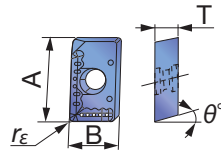

WCMT-D4

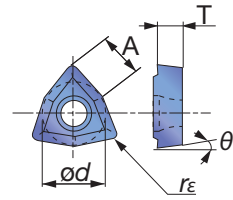

P	Steel	★		
M	Stainless		★	
K	Cast iron	★		
N	Non-ferrous			
S	Superalloys			
H	Hard materials			

★ : First choice
☆ : Second choice

Designation	rε	Coated		A	ød	T	θ°	B
		AH120	AH140					
XXMU08T204PR-MJ	0.016	●	●	0.323	-	0.109	10	0.220
XXMU10H308PR-MJ	0.031	●	●	0.417	-	0.138	11	0.268
XXMU12X408PR-MJ	0.031	●	●	0.520	-	0.165	11	0.311
XXMU16X508PR-MJ	0.031	●	●	0.661	-	0.197	11	0.437
WCMT050308-D4	-	●	●	0.313	0.313	0.125	7	-
WCMT06T308-D4	-	●	●	0.375	0.375	0.156	7	-

● : Line up

STANDARD CUTTING CONDITIONS

ISO	Workpiece material	Grade	øD: ø0.625" - ø0.787"			øD: ø1.000" - ø1.250"		
			Cutting speed Vc (sfm)	Feed per tooth fz (ipt)		Cutting speed Vc (sfm)	Feed per tooth fz (ipt)	
				Shouldering, Grooving	Drilling		Shouldering, Grooving	Drilling
P	Carbon steels (1018, 1055, etc.) < 300 HB	AH120	330 - 590	0.002 - 0.008	0.001 - 0.003	400 - 650	0.003 - 0.010	0.002 - 0.004
	Alloy steels (4140, 4340, etc.) < 300 HB	AH120	260 - 525	0.002 - 0.006	0.001 - 0.003	330 - 590	0.003 - 0.008	0.002 - 0.004
	Die steels (H-13, etc.) < 300 HB	AH120	200 - 400	0.002 - 0.005	0.001 - 0.002	260 - 500	0.003 - 0.006	0.001 - 0.003
M	Stainless steels (304SS, etc.)	AH140	230 - 460	0.002 - 0.006	0.001 - 0.003	300 - 525	0.003 - 0.008	0.001 - 0.003
K	Cast irons (Class 25, etc.)	AH120	330 - 590	0.002 - 0.010	0.001 - 0.004	400 - 650	0.003 - 0.010	0.002 - 0.004

APPLICATION RANGE

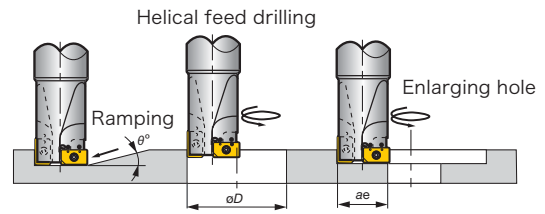
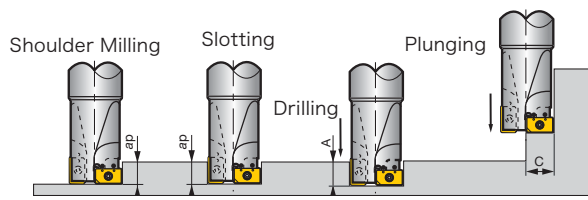

Multi Function

		Max. depth of cut	Max. drilling depth	Max. cutting width in plunging	Max. ramping angle	Min. machining hole dia.	Max. machining hole dia.	Max. cutting width in enlarging hole
Inch		a_p	A	C	θ°	ϕD_{min}	ϕD_{max}	a_e
Standard type / Long type	EVX08062RSU/RLHU	0.625	0.276	0.315	3°	0.756	1.250	0.551
	EVX10020RSU/RLHU	0.750	0.354	0.394	3°	0.945	1.500	0.709
	EVX12100RSU/RLHU	1.000	0.453	0.492	3°	1.250	1.890	0.906
	EVX16125RSU/RLHU	1.250	0.591	0.630	3°	1.510	2.440	1.250



Multi Function

ECC31

Indexable chamfering cutter with large parallelogram insert

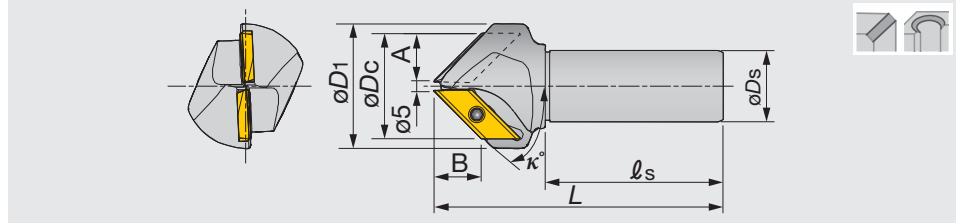

Inch	ϕD_c	z	κ°	ϕD_1	A	B	ϕD_s	l_s	L	Insert
ECC31005RU-45	1.846	2	45	2.205	0.197	0.827	1.000	2.281	4.250	XCET3104...
ECC31005RU-30	1.338	1	30	1.575	0.197	1.004	1.000	2.281	4.250	XCET3104...
ECC31005RU-60	2.204	2	60	2.834	0.197	0.571	1.000	2.281	4.250	XCET3104...
ECC31005RU-41	1.698	2	41	2.205	0.197	0.866	1.000	2.281	4.250	XCET3104...
Metric	ϕD_c	z	κ°	ϕD_1	A	B	ϕD_s	l_s	L	Insert
ECC31005R-30	34	1	30	40	14.5	25.5	32	80	130.2	XCET3104...
ECC31005R-45	46	2	45	56	20.5	20.5	32	80	130.1	XCET3104...
ECC31005R-60	55	2	60	72	25.5	14.5	32	80	130.1	XCET3104...

SPARE PARTS



Designation	Clamping screw	Lubricant	Wrench
ECC31...	CSTB-5S	M-1000	T-20D

INSERT

XCET31

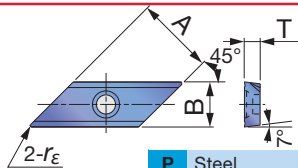

P	Steel	☆	☆	★	☆					
M	Stainless	★								
K	Cast iron	☆	★							
N	Non-ferrous					★				
S	Superalloys									
H	Hard materials									

★ : First choice
☆ : Second choice

Designation	r_ϵ	Coated	Cermet	Un-coated	A	B	T
		AH330 AH120	NS740	UX30 TH10			
XCET310404ER	0.016	● ●	●	● ●	0.866	0.500	0.177

● : Line up

STANDARD CUTTING CONDITIONS

ISO	Workpiece material	Grade	Cutting speed: V_c (sfm)	Feed per tooth: f_z (sfm)
P	Carbon steels 1055, etc.	NS740	300 - 750	0.004 - 0.010
	Alloy steels 4140, etc.	UX30	250 - 500	0.004 - 0.010
	< 300 HB Die steels H13, etc.	AH120	250 - 450	0.004 - 0.008
M	Stainless steels S30400, etc.	AH330	300 - 650	0.004 - 0.010
K	Cast irons No.250B, etc.	AH120	500 - 900	0.004 - 0.010
N	Aluminum	TH10	1500 - 3500	0.004 - 0.010

Notes:

- When the hole diameter to be chamfered is small or the cutting edges near the front end of tool are used, use at higher side of the revolution range shown in the Table.
- In contrast, when the hole diameter to be chamfered is large or the cutting edges far from the tool's front end are used, use the lower side of the revolution range shown in the Table.

- When chamfering a small diameter hole (smaller than $\phi 0.400''$) in a plunge-milling mode, peck-feeding should not be used.
- When the hole diameter to be chamfered is smaller than $\phi 0.400''$ or the cutting edges near the tool's front end are used, the feed should be set within 0.006".



Guidelines for programming

Z-axis plunging depth Z_d (in) in 45° chamfering of hole

Hole dia. ϕd (in)	Size of chamfering C (in)							
	0.020	0.039	0.059	0.079	0.118	0.157	0.197	
0.197	0.028	0.047	0.067	0.087	0.126	-	-	
0.236	0.047	0.067	0.087	0.106	0.146	-	-	
0.268	0.063	0.083	0.102	0.122	0.161	-	-	
0.315	0.087	0.106	0.126	0.146	0.185	-	-	
0.335	0.094	0.114	0.134	0.154	0.193	-	-	
0.394	0.126	0.146	0.165	0.185	0.224	0.264	0.303	
0.402	0.130	0.150	0.169	0.189	0.228	0.268	0.307	
0.472	0.165	0.185	0.205	0.224	0.264	0.303	0.343	
0.551	0.205	0.224	0.244	0.264	0.303	0.343	0.382	
0.630	0.244	0.264	0.283	0.303	0.343	0.382	0.421	
0.689	0.272	0.291	0.311	0.331	0.370	0.408	0.449	
0.787	0.323	0.343	0.362	0.382	0.421	0.461	0.500	
0.827	0.343	0.362	0.382	0.402	0.441	0.480	0.520	
0.945	0.402	0.421	0.441	0.461	0.500	0.539	0.579	
1.181	0.520	0.539	0.559	0.579	0.618	0.657	0.697	
1.299	0.579	0.598	0.618	0.638	0.677	0.717	0.756	
1.417	0.638	0.657	0.677	0.697	0.736	0.776	-	
1.654	0.756	0.776	0.795	-	-	-	-	

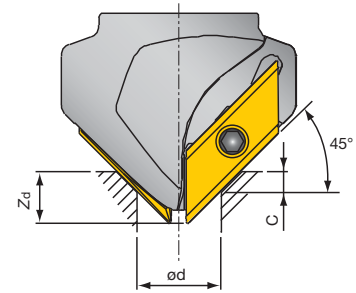

Tool: ECC31005R-45

Note: When the hole depth is smaller than the Z-axis plunging depth (Z_d), special care should be taken to avoid an interference between the tool's front end and the bottom of the hole.

Z-axis plunging depth Z_d (in) in 30° chamfering of hole

Hole dia. ϕd (in)	Size of chamfering C (in)							
	0.020	0.039	0.059	0.079	0.098	0.118	0.138	
0.197	0.024	0.043	0.063	0.083	-	-	-	
0.236	0.035	0.055	0.075	0.094	-	-	-	
0.268	0.043	0.063	0.083	0.102	-	-	-	
0.315	0.055	0.075	0.094	0.114	-	-	-	
0.335	0.063	0.083	0.102	0.122	-	-	-	
0.394	0.079	0.098	0.118	0.138	0.157	0.177	0.197	
0.402	0.083	0.102	0.122	0.142	0.161	0.181	0.201	
0.472	0.102	0.122	0.142	0.161	0.181	0.201	0.220	
0.551	0.146	0.165	0.185	0.205	0.224	0.244	0.264	
0.630	0.165	0.185	0.205	0.224	0.244	0.264	0.283	
0.689	0.193	0.213	0.232	0.252	0.272	0.291	0.311	
0.787	0.205	0.224	0.244	0.264	0.283	0.303	0.323	
0.827	0.240	0.260	0.280	0.299	0.319	0.339	0.358	
0.945	0.307	0.327	0.346	0.366	0.386	0.406	0.45	
1.181	0.343	0.362	0.382	0.402	0.421	0.441	0.461	
1.299	0.374	0.394	0.413	0.433	0.453	0.472	0.492	
1.417	0.398	0.417	0.437	0.457	0.476	0.496	0.516	
1.654	0.441	0.461	0.480	0.500	0.520	0.539	0.559	
1.811	0.488	0.508	0.528	0.547	0.567	-	-	
1.890	0.512	0.531	0.551	0.571	-	-	-	
2.047	0.555	-	-	-	-	-	-	

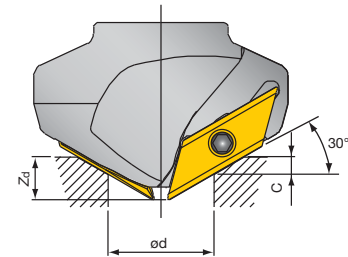

Tool: ECC31005R-60

Note: When the hole depth is smaller than the Z-axis plunging depth (Z_d), special care should be taken to avoid an interference between the tool's front end and the bottom of the hole.

Z-axis plunging depth Z_d (in) in 60° chamfering of hole

Hole dia. ϕd (in)	Size of chamfering C (in)								
	0.020	0.039	0.059	0.079	0.098	0.118	0.138	0.157	
0.197	0.031	0.051	0.071	0.091	0.110	-	-	-	
0.236	0.067	0.087	0.106	0.126	0.146	-	-	-	
0.268	0.094	0.114	0.134	0.154	0.173	-	-	-	
0.315	0.134	0.154	0.173	0.193	0.213	-	-	-	
0.335	0.150	0.169	0.189	0.209	0.228	-	-	-	
0.394	0.201	0.220	0.240	0.260	0.280	0.299	0.319	0.339	
0.402	0.209	0.228	0.248	0.268	0.287	0.307	0.327	0.346	
0.472	0.272	0.291	0.311	0.331	0.350	0.370	0.390	0.409	
0.551	0.406	0.425	0.445	0.465	0.484	0.504	0.524	0.543	
0.630	0.457	0.476	0.496	0.516	0.535	0.555	0.575	0.594	
0.689	0.539	0.559	0.579	0.598	0.618	0.638	0.657	0.677	
0.787	0.575	0.594	0.614	0.634	0.654	0.673	0.693	0.713	
0.827	0.677	0.697	0.717	0.736	0.756	0.776	0.795	0.815	
0.945	0.882	0.902	0.921	0.941	0.961	0.980	1.000	-	
1.181	0.980	1.000	-	-	-	-	-	-	

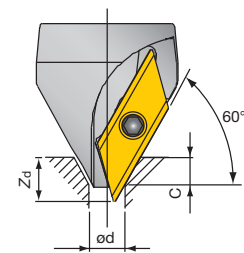

Tool: ECC31005R-30

Note: When the hole depth is smaller than the Z-axis plunging depth (Z_d), special care should be taken to avoid an interference between the tool's front end and the bottom of the hole.



Multi Function

ECP4400R

Indexable chamfering cutter with square insert

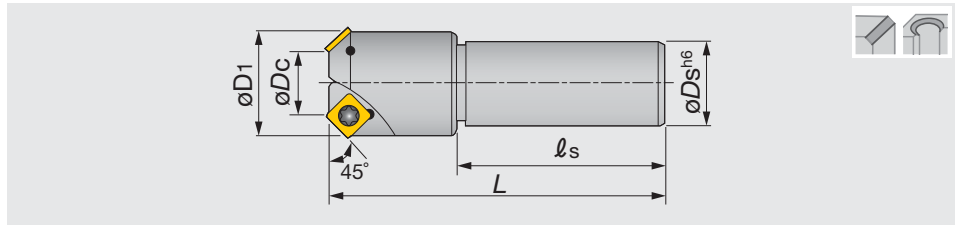

Inch	ϕD_C	z	ϕD_1	ϕD_S	L	ℓ_s	Insert
ECP440AR-U	0.394	1	1.083	1.250	4.50	2.48	SPMA422*N
ECP4423R-U	0.906	2	1.587	1.250	4.50	2.48	SPMA422*N
ECP4436R-U	1.417	3	2.098	1.250	4.50	2.48	SPMA422*N
Metric	ϕD_C	z	ϕD_1	ϕD_S	L	ℓ_s	Insert
ECP440AR	10	1	27.5	32	130	80	SPMA422*N
ECP4423R	23	2	40.3	32	130	80	SPMA422*N
ECP4436R	36	3	53.3	32	130	80	SPMA422*N

SPARE PARTS

Designation	Clamping screw	Wrench
ECP44...	CSTA-4	T-15D

INSERT

SPMA42

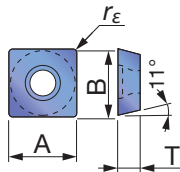

P Steel	★		☆						
M Stainless									
K Cast iron				★					
N Non-ferrous									
S Superalloys									
H Hard materials									

★ : First choice
☆ : Second choice

Designation	r_E	Cermet		Uncoated		A	B	T
		NS740		UX30	TH10			
SPMA422TN	0.031	●		●		0.500	0.500	0.215
SPMA422FN	0.031			●		0.500	0.500	0.215

● : Line up

STANDARD CUTTING CONDITIONS

Operations	Workpiece material	Grade	Cutting speed V_c (sfm)	Maximum depth of cut a_p (in)	Feed per tooth f_z (ipt)
Single or double chamfering hole chamfering 	Carbon steels, Alloy steels < 300HB Die steels < 30HRC	NS740 · N308 UX30	330 - 490	-	0.008 - 0.029
		NS740 · N308 UX30	164 - 230	-	0.006 - 0.016
	Cast irons	TH10	90 - 110	-	0.008 - 0.024
Facing Grooving 	Carbon steels, Alloy steels < 300HB Die steels < 30HRC	NS740 · N308 UX30	330 - 490	0.118	0.004 - 0.006
		UX30	164 - 230	0.079	0.004 - 0.006
	Cast irons	TH10	295 - 360	0.118	0.004 - 0.006

Notes:

- When chamfering stainless steel, down-milling is recommended. Conventional milling may cause edge chipping.
- When chamfering above C3.0, the feed per tooth should be set at the lower side of the value shown in the above table.

TCB

Indexable counter boring endmill



Multi Function

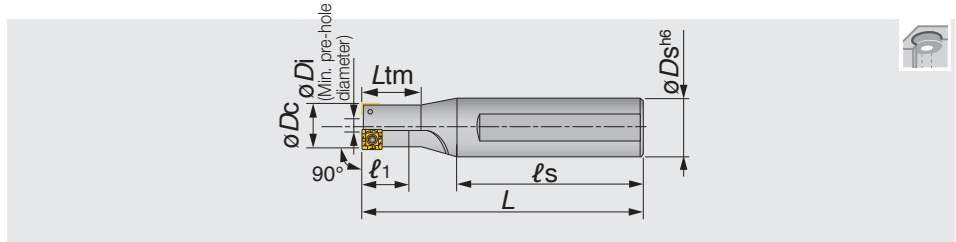

Metric	ϕD_c	z	ϕD_i	ℓ_1	L_{tm}	L	ℓ_s	ϕD_s	Insert
TCB100F16	10	1	2.8	13	17	86	60	16	SPMP771...
TCB110F16	11	1	2.8	14	18.7	87	60	16	SPMP771...
TCB120F20	12	1	3.6	15	20.5	89	60	20	SPMP771...
TCB130F20	13	2	4.5	16	22.2	91	60	20	SPMP771...
TCB-140	14	1	4	11	18	117	80	25	SPMP831...
TCB140F25	14	2	5.5	18	24	113	80	25	SPMP771...
TCB150F25	15	2	6.5	19	25.7	114	80	25	SPMP771...
TCB160F25	16	2	7.5	20	27.5	116	80	25	SPMP771...
TCB170F25	17	2	6.6	13	21	114	80	25	SPMP831...
TCB175F25	17.5	2	7.1	14	22	115	80	25	SPMP831...
TCB180F25	18	2	7.5	15	23	116	80	25	SPMP831...
TCB190F25	19	2	8.5	15	24	118	80	25	SPMP831...
TCB-200	20	2	8.2	16	25	120	80	25	SPMP042...
TCB200F25	20	2	8.2	16	25	120	80	25	SPMP042...
TCB210F25	21	2	9	17	26	122	80	25	SPMP042...
TCB220F25	22	2	10	18	28	124	80	25	SPMP042...
TCB-230	23	2	11	19	29	126	80	25	SPMP042...
TCB230F25	23	2	11	19	29	126	80	25	SPMP042...
TCB240F25	24	2	12	20	-	128	80	25	SPMP042...
TCB250F25	25	2	13	25	-	130	80	25	SPMP042...
TCB-260	26	2	14	21	33	132	80	32	SPMP042...
TCB-290	29	2	14	23	36	138	80	32	SPMM322...
TCB-320	32	2	16.9	40	-	144	80	32	SPMM322...
TCB-350	35	2	14	43	-	150	80	32	SPMM432...
TCB-390	39	2	17.9	48	-	158	80	32	SPMM432...
TCB-430	43	2	21.7	53	-	171	85	42	SPMM432...

TCB-... : Existing items with black oxide

TCB**F... : New items with nickel plating

Tool diameter tolerance	Applicable tolerance range of hole diameter
+0.2 / 0	+0.3 / 0

Counter sink dimensions of bolt hole

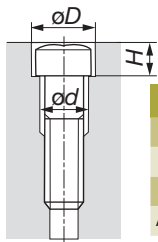

Thread size	M6	M8	M10	M12	M14	M16	M18	M20	M22	M24	M27
ϕD (mm)	11	14	17.5	20	23	26	29	32	35	39	43
H (mm)	6.5	8.6	10.8	13	15.2	17.5	19.5	21.5	23.5	25.5	29
ϕd (mm)	6	9	11	14	16	18	20	22	24	26	30
Applicable tool	TCB110	TCB140	TCB175	TCB200	TCB230	TCB260	TCB290	TCB320	TCB350	TCB390	TCB430

SPARE PARTS



Designation	Clamping screw	Wrench
TCB100... - TCB160...	CSTB-2L040	T-6D
TCB-140...	CSTB-2.2S	T-7D
TCB170... - TCB190...	CSTB-2.2	T-7D
TCB200... - TCB260...	CSTA-NO3	T-9D
TCB-290 - TCB-320	CSTA-NO5	T-9D
TCB-350 - TCB-430	CSTA-4	T-15D

Reference pages

Inserts, Standard cutting conditions → **D210**



INSERT

SPMP/SPMM

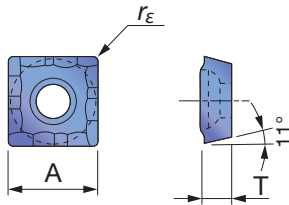

P	Steel	★																		
M	Stainless	★																		
K	Cast iron	★																		
N	Non-ferrous																			
S	Superalloys																			
H	Hard materials																			

★ : First choice
☆ : Second choice

Designation	rε	Coated										A	T	
		T313W												
SPMP831DS	0.016	●											0.250	0.094
SPMP042ERD	0.031	●											0.313	0.125
SPMM322ERD	0.031	●											0.375	0.125
SPMM432ERD	0.031	●											0.500	0.187

● : Line up

STANDARD CUTTING CONDITIONS

ISO	Workpiece material	Grade	Cutting speed Vc (sfm)	Feed f (ipr)	Cutting fluid
P	Carbon steels	T313W	260 - 490	0.005 - 0.009	Water soluble type
M	Stainless steels, Mild steels	T313W	490 - 560	0.002 - 0.005	Water soluble type
K	Cast irons	T313W	230 - 430	0.008 - 0.016	Water soluble type or dry cutting

Notes :

- For cutters under 0.787" diameter, be sure to use a cutting fluid and select lower cutting speeds than shown above.
- For TCB-140 type, reduce the feeds to 1/2 of the values shown in the table.

Single tooth threading mills

Indexable threading mills



Multi Function

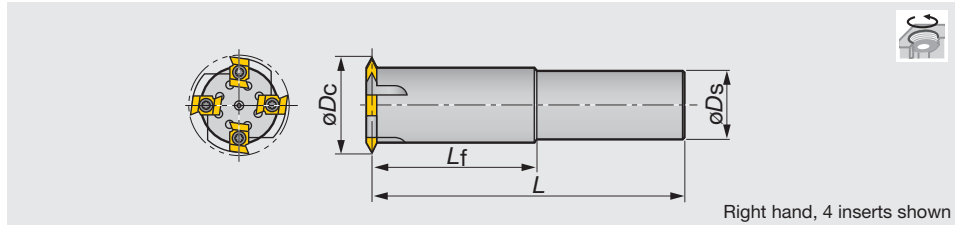

Right hand, 4 inserts shown

Metric	ϕD_c	z	ϕD_s	L_f	L	Range of internal thread	Insert
D23-D25-45R	23	1	25	45	115	M28 - M30	T1-R...
D25-D25-45R	25	1	25	45	115	M32 - M42	T1-R...
D38-D32-85R	38	2	32	85	165	M45 - M56	T1-R...
D50-D42-100R	50	4	42	100	190	M58 - M68	T1-R...
D55-D42-100R	55	4	42	100	190	M64 - M85	T2-R...
D60-D42-100R	60	4	42	100	190	M70 - M85	T2-R...
D80-D42-100R	80	6	42	100	190	M90 -	T2-R...

SPARE PARTS



Designation	Clamping screw	Wrench
D23-D25... - D50-D42...	CSTB-4	T-15F
D55-D42... - D80-D42...	CSTB-5	T-20F

INSERT

T*-R...

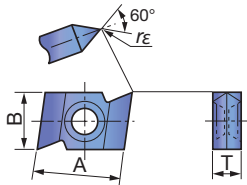

P	Steel	★																		
M	Stainless	★																		
K	Cast iron																			
N	Non-ferrous																			
S	Superalloys																			
H	Hard materials																			

★ : First choice
☆ : Second choice

Designation	r_ϵ	Coated										A	B	T	
		GH330													
T1-R14	0.006	●											0.567	0.375	0.187
T1-R28	0.011	●											0.567	0.375	0.187
T2-R14	0.006	●											0.701	0.500	0.250
T2-R28	0.011	●											0.701	0.500	0.250

● : Line up

STANDARD CUTTING CONDITIONS

ISO	Workpiece material	Grade	Cutting speed V_c (sfm)	Feed per tooth f_z (ipt)
P	Mild steels / Unharded steels < 200HB	GH330	490 - 660	0.012 - 0.016
	Carbon steels / Alloy steels < 300HB	GH330	490 - 660	0.007 - 0.010
	Die steels < 50HRC	GH330	100 - 160	0.006 - 0.008
M	Stainless steels < 300HB	GH330	490 - 660	0.002 - 0.005

- Climb milling is recommended.
- When threading a blind hole, use the right hand cutter in right-hand rotation. Cut up from the bottom to prevent chip recutting.
- When machining internal threads from the mouth, use the left-hand cutter in left-hand rotation.

Milling Insert

Insert

● ACMT**PR-MJ

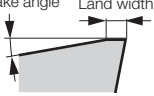
Shape	Designation	Coated				Applicable mills
		AH120	AH140	GH330	T3130	
 Rake angle Land width  -MJ	ACMT060308PR-MJ	●	●	●	●	ELP07/09/12...
	ACMT07T308PR-MJ	●	●	●	●	
	ACMT100408PR-MJ	●	●	●	●	

● ADMT**PR-MJ

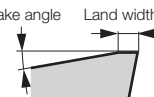
Shape	Designation	Coated			Applicable mills
		AH120	AH140	T3130	
 Rake angle Land width  -MJ	ADMT130308PR-MJ	●	●	●	ELP13/17/21...
	ADMT17T308PR-MJ	●	●	●	
	ADMT210408PR-MJ	●	●	●	

● AECW**PEFR, AECW**PESR, AEMW**PEFR, AEMW**PETR

Shape	Designation	Coated		Cermet	Uncoated		Applicable mills
		AH120	GH330	NS740	UX30	TH10	
	AECW1403PEFR					●	EPE4000/5000/6000...
	AECW1403PESR	●	●	●	●		
	AECW16T3PEFR					●	
	AECW16T3PESR	●	●	●	●		
	AECW1804PEFR					●	
	AECW1804PESR	●	●	●	●		
	AEMW1403PEFR					●	
	AEMW1403PETR		●	●	●		
	AEMW16T3PEFR					●	
	AEMW16T3PETR		●	●	●		
	AEMW1804PEFR					●	
	AEMW1804PETR		●	●	●		



● ANEA542TN, ANEA642TN

Shape	Designation	Uncoated						Applicable mills
		UX30						
	ANEA542TN	●						VSN... (Former products)
	ANEA642TN	●						

●: Line up

Milling Insert

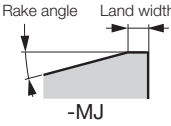

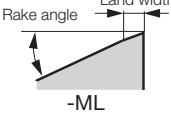

● ANMT**PPPR-MJ, ANMT**PPPR-ML

Shape	Designation	Coated			Applicable mills
		AH120	GH330	T3130	
	ANMT09T3PPPR-MJ	●	●	●	EPN09 (Former products)
	ANMT09T3PPPR-ML	●			
	ANMT1404PPPR-MJ	●	●	●	EPN14... TPN14... (Former products)
	ANMT1404PPPR-ML	●			
					
					

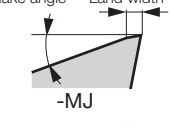

Insert

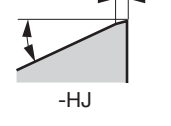
● AOMT**PDPR-MJ, AOGT**PDFR-AJ, AOMT070208PDPR-HJ

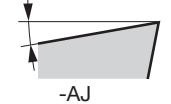
Shape	Designation	Coated		Uncoated	Applicable mills
		AH140	AH725	KS15F	
	AOMT070202PDPR-MJ	●	●		TUNGREC TPO07... Page D054
	AOMT070204PDPR-MJ	●	●		
	AOMT070208PDPR-MJ	●	●		EPO07... Page D054
	AOMT070216PDPR-MJ	●	●		
	AOMT070208PDPR-HJ	●	●		HPO07... Page D055
	AOGT070204PDFR-AJ			●	
					
					
					

●: Line up

Milling Insert

Insert

● AOMT**PDPR-MJ, AOGT**PDFR-AJ

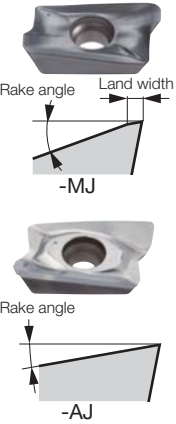
Shape	Designation	Coated		Uncoated		Applicable mills
		AH140	AH725	KS15F		
	AOMT180508PDPR-MJ	●	●			TUNGREC TPO18... Page D065 EPO18... Page D066
	AOMT180516PDPR-MJ	●	●			
	AOMT180524PDPR-MJ	●	●			
	AOMT180532PDPR-MJ	●	●			
	AOGT180504PDFR-AJ			●		
	AOGT180508PDFR-AJ			●		

● APMT**PN-MJ

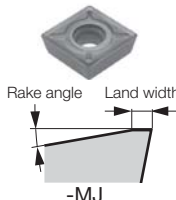
Shape	Designation	Coated				Applicable mills
		AH120	AH140	GH330	T3130	
	APMT070308PN-MJ	●	●	●	●	ELP07/09/12...
	APMT09T308PN-MJ	●	●	●	●	
	APMT120408PN-MJ	●	●	●	●	

● APMT120416PR-MJ

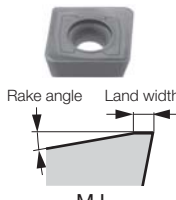
Shape	Designation	Coated		Applicable mills
		AH120	T3130	
	APMT120416PR-MJ	●	●	TZP12...





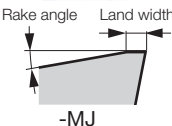

●: Line up

Milling Insert

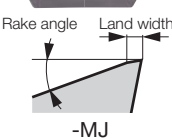
● APMR190616PR-MJ

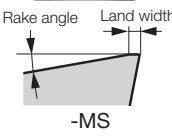
Shape	Designation	Coated								Applicable mills
		AH120	T3130							
  -MJ	APMR190616PR-MJ	●	●							TZP19...

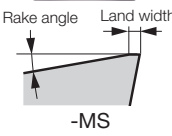
● ASMT**PDPR-MJ, ASGT11**PDFR-AJ, ASMT11T304PDPR-MS

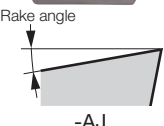
Shape	Designation	Coated								Cermet	Uncoated	Applicable mills
		AH120	AH130	AH140	AH725	T1115	T1215	T3130	DS1100	NS740	KS05F	
  -MJ	ASMT11T304PDPR-MJ	●	●		●	●		●	●			TUNGREC TPS11... Page D058 TLS11... Page D059 EPS11... Page D058
	ASMT11T308PDPR-MJ	●	●	●	●	●	●	●	●			
	ASMT11T312PDPR-MJ	●	●		●			●	●			
	ASMT11T316PDPR-MJ	●	●		●			●	●			
	ASMT11T320PDPR-MJ	●	●									
  -MJ	ASMT11T330PDPR-MJ	●	●									HPO11... Page D060
	ASMT11T304PDPR-MS		●	●								
  -MS	ASGT11T304PDFR-AJ							●	●			ELS11... Page D059
	ASGT11T308PDFR-AJ								●	●		
  -AJ												

●: Line up







Insert

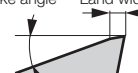

Milling Insert

● ASMT17**PDPR-MJ, ASGT17**PDFR-AJ, ASMT170508PDPR-MS

Insert

Shape	Designation	Coated					Cermet	Uncoated	Applicable mills
		AH120	AH130	AH140	T1115	T3130	DS1100	NS740	
 Rake angle Land width -MJ	ASMT170504PDPR-MJ	●	●		●	●			TPS17... Page D089
	ASMT170508PDPR-MJ	●	●	●	●	●			
	ASMT170512PDPR-MJ	●	●			●			
 Rake angle Land width -MJ	ASMT170516PDPR-MJ	●				●		EPS17... Page D089	
	ASMT170520PDPR-MJ	●							
	ASMT170530PDPR-MJ	●							
 Rake angle Land width -MJ	ASMT170532PDPR-MJ	●				●			
	ASMT170508PDPR-MS		●	●					
	ASGT170504PDFR-AJ						●		●
 Rake angle Land width -MS	ASGT170508PDFR-AJ						●		
	ASGT170508PDFR-AJ						●	●	
 Rake angle -AJ									

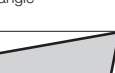
● AVGT**PBER-MJ, AVGT**PBFR-AJ

Shape	Designation	Coated		Uncoated	Applicable mills
		AH120	AH3135	KS05F	
 Rake angle -MJ	AVGT060302PBER-MJ	●	●		TUNGFRÉC EPAV... Page D050
	AVGT060304PBER-MJ	●	●		
	AVGT060308PBER-MJ	●	●		
 Rake angle -MJ	AVGT060302PBFR-AJ			●	HPAV06... Page D050
	AVGT060304PBFR-AJ			●	
	AVGT060308PBFR-AJ			●	
 Rake angle -AJ					

●: Line up

Milling Insert

● CPMW**-EN, CPMT**-EN

Shape	Designation	Coated		Uncoated					Applicable mills
		GH330		UX30					
	CPMW050208EN	●		●					EVP1000 (Former products)
	CPMW06T208EN	●		●					
	CPMT080308EN	●		●					

● DCMW**TN

Shape	Designation	Coated						Applicable mills
		AH120	AH330					
	DCMW070204TN	●	●					EBP... Page D164 HBP...
	DCMW11T304TN	●	●					

● DPCW11T3ZFR

Shape	Designation	Coated	Cermet					Applicable mills
		AH740	NS740					
	DPCW11T3ZFR	●	●					TZF11... HZF11...

● EDKW53ZTR

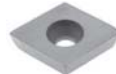
Shape	Designation	Coated	Uncoated					Applicable mills
		GH330	UX30					
	EDKW53ZTR	●	●					ESD5000 (Former products)

●: Line up



Insert



Milling Insert

Insert

● ENEQ**TN-T

Shape	Designation	Coated								Applicable mills
		AH120								
	ENEQ090508TN-T	●								VSNE09... (Former products)
	ENEQ100508TN-T	●								VSNE10... (Former products)
	ENEQ130608TN-T	●								VSNE13... (Former products)
	ENEQ160608TN-T	●								VSNE16... (Former products)

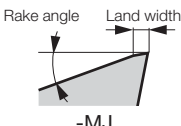
● GDMT**PDPR-MJ, GDGT**PDFR-AJ

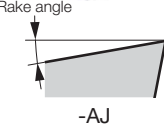
Shape	Designation	Coated					Uncoated		Applicable mills
		AH120	AH140	AH330	T3130	DS1100	UX30	TH10	
 Rake angle Land width  -MJ  Rake angle  -AJ	GDMT10H3PDPR-MJ	●	●	●	●		●		TSD10/17...
	GDMT17X6PDPR-MJ	●	●	●	●		●		ESD10/17...
	GDGT10H3PDFR-AJ					●		●	HSD10/17...
	GDGT17X6PDFR-AJ					●		●	

● HEHN532FN

Shape	Designation	Uncoated								Applicable mills
		TH10								
	HEHN532FN	●								QYE5300 (Former products)

● : Line up

Milling Insert

● HPKN532FN

Shape	Designation	Uncoated							Applicable mills
		TH10							
	HPKN532FN	●							QYP5300 (Former products)

● LMEU**ZNEN-MJ

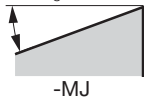
Shape	Designation	Coated								Applicable mills
		AH120	AH140	AH725						
 Rake angle  -MJ	LMEU100808ZNEN-MJ	●	●	●						TEC T-SLOT ASN 10/12/15... Page D136 TSN 10/12/15... Page D137
	LMEU100816ZNEN-MJ	●	●	●						
	LMEU100824ZNEN-MJ	●	●	●						
	LMEU100832ZNEN-MJ	●	●	●						
	LMEU120808ZNEN-MJ	●	●	●						
	LMEU120816ZNEN-MJ	●	●	●						
	LMEU120824ZNEN-MJ	●	●	●						
	LMEU120832ZNEN-MJ	●	●	●						
	LMEU150908ZNEN-MJ	●	●	●						
	LMEU150916ZNEN-MJ	●	●	●						
	LMEU150924ZNEN-MJ	●	●	●						
	LMEU150932ZNEN-MJ	●	●	●						

● LMMU**PNER-MJ

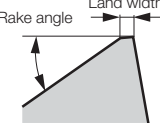
Shape	Designation	Coated								Applicable mills
		AH120	AH140	AH725						
 Rake angle Land width  -MJ	LMMU110708PNER-MJ	●	●	●						TECMILL TPM11/16... Page D079 TLM11... Page D080 EPM11... Page D079
	LMMU110716PNER-MJ	●	●	●						
	LMMU110724PNER-MJ	●	●	●						
	LMMU110732PNER-MJ	●	●	●						
	LMMU160908PNER-MJ	●	●	●						
	LMMU160916PNER-MJ	●	●	●						
	LMMU160924PNER-MJ	●	●	●						
	LMMU160932PNER-MJ	●	●	●						

● : Line up



Milling Insert

Insert

● LNCA64ZTR

Shape	Designation	Coated		Uncoated					Applicable mills
		T3130		UX30					
	LNCA64ZTR	●		●					VSN6000I (Former products)

● LNCQ0906N-**L, LNCQ0906R-50S

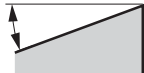
Shape	Designation	Coated		Cermet					Applicable mills
		AH120	GH110	NS740					
	LNCQ0906N-100L	●	●	●					NMS09...
	LNCQ0906N-50L	●	●	●					EMS09...
	LNCQ0906R-50S	●	●	●					
									



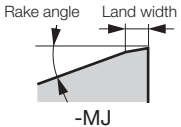
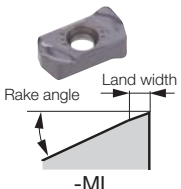

● LNMU0303ZER-MJ, LNMU0303ZER-ML

Shape	Designation	Coated								Applicable mills
		AH130	AH725	AH3035	AH8015					
	LNMU0303ZER-MJ	●	●	●	●					DOFEED TXN03... Page D008 EXN03... Page D008 HXN03... Page D009
	LNMU0303ZER-ML	●	●	●	●					
										
										



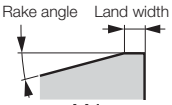

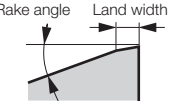
● : Line up

Milling Insert

● LNMU06X5ZER-MJ, LNMU06X5ZER-ML, LNGU06X5ZER-W

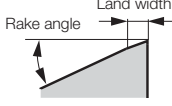
Shape	Designation	Coated					Applicable mills
		AH120	AH130	AH725	AH3035	AH8015	
  -MJ	LNMU06X5ZER-MJ	●	●	●	●	●	DOFEED TXN06... Page D012 EXN06... Page D013
	LNMU06X5ZER-ML	●	●	●	●	●	
	LNGU06X5ZER-W			●			
  -ML							
 -W							

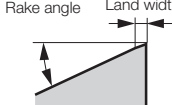
● LNMX0405R4-MJ, LNMX0405R4-ML, LNMX0405R4-HJ

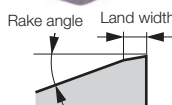
Shape	Designation	Coated		Applicable mills
		AH120	AH3135	
  -MJ	LNMX0405R4-MJ	●	●	DOTWIST BALL TXLN... Page D016 EXLN... Page D016 HXLN... Page D017
	LNMX0405R4-ML	●	●	
	LNMX0405ZER-HJ	●	●	
  -ML				
  -HJ				

●: Line up





Insert

Milling Insert

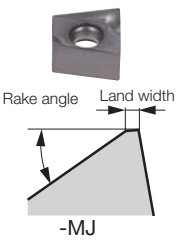
● LQMU**PNER-MJ

Shape	Designation	Coated								Applicable mills
		AH120	AH140	AH725						
 <p>Rake angle Land width</p> <p>-MJ</p>	LQMU110704PNER-MJ	●	●	●						DOREC TPQ11/18... Page D076 EPQ11... Page D077
	LQMU110708PNER-MJ	●	●	●						
	LQMU110716PNER-MJ	●	●	●						
	LQMU180804PNER-MJ	●	●	●						
	LQMU180808PNER-MJ	●	●	●						
	LQMU180816PNER-MJ	●	●	●						
	LQMU180824PNER-MJ	●	●	●						

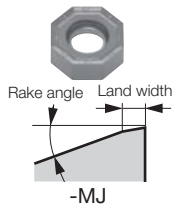
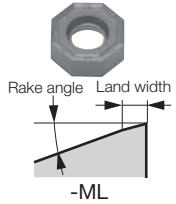
● ONMU0705ANPN-MJ, ONHU0705ANPN-MJ, ONMU0705ANPN-ML, ONHU0705ANTN-ML, ONHU0705ANPR-W

Shape	Designation	Coated										Applicable mills
		AH120	AH140	AH725	AH3135	T1115	T1215					
 <p>Rake angle Land width</p> <p>-MJ</p>	ONMU0705ANPN-MJ		●	●	●		●					DOOCTO DOQUAD TAN07... Page D101
	ONHU0705ANPN-MJ		●	●								
	ONMU0705ANPN-ML	●			●							
	ONHU0705ANTN-ML	●	●	●								
	ONHU0705ANPR-W	●										
 <p>Rake angle Land width</p> <p>-ML</p>												
 <p>-W</p>												

● : Line up

Milling Insert

● ONGU0507ANEN-MJ, ONGU0507ANEN-W, ONMU0507ANEN-MJ

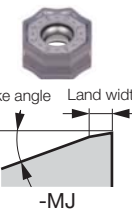
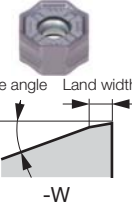
Shape	Designation	Coated				Applicable mills
		AH120	AH3135	T3225	T1215	
 -MJ	ONGU0507ANEN-MJ	●	●	●		DOTMILL TASN13... Page D098
	ONGU0507ANEN-W	●	●			
	ONMU0507ANEN-MJ	●	●	●	●	
 -W						

● OWMT0807ZNER-HJ, OWMT0807AAER-ML

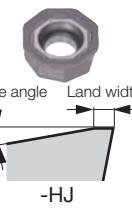
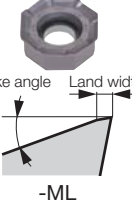
Shape	Designation	Coated		Applicable mills
		AH130	AH3135	
 -HJ	OWMT0807ZNER-HJ		●	DOOCTO DOQUAD TAN07... Page D101
	OWMT0807AAER-ML	●	●	
 -ML				



●: Line up



Insert

Milling Insert

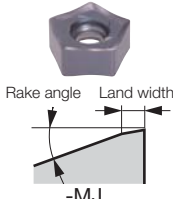
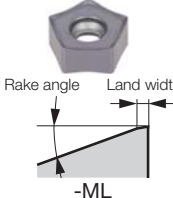
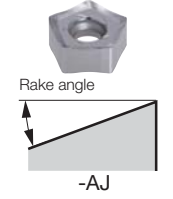
- PNCU0905GNER-MJ, PNCU0905GNEN-ML, PNCU0905GNFR-AJ, PNMU0905GNEN-MJ, PNCU0905GNER-W

Shape	Designation	Coated						Cermet	Uncoated		Applicable mills
		AH120	AH140	AH725	AH3135	T1115	T1215	T3130	NS740	TH10	
 <p>-MJ</p>  <p>-ML</p>  <p>-AJ</p>  <p>-W</p>	PNCU0905GNER-MJ	●	●	●	●	●	●			DOPENT TEN09R... Page D106 EEN09... Page D107	
	PNCU0905GNEN-ML				●						
	PNCU0905GNFR-AJ								●		
	PNMU0905GNEN-MJ		●		●		●				
	PNCU0905GNER-W				●						

●: Line up

Insert

Milling Insert

● RCMT**EN-MJ, RCMT**EN-NMJ, RCMT**FN-NAJ

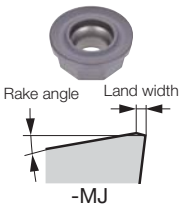
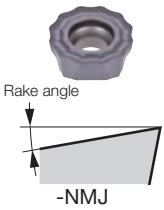
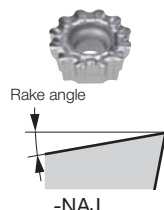
Shape	Designation	Coated			Uncoated		Applicable mills
		AH120	AH140	AH725	KS15F		
 -MJ	RCMT1204EN-MJ	●	●	●			ROUNDSPLIT TRC12/16... Page D155 ERC12/16... Page D156
	RCMT1204EN-NMJ	●	●	●			
	RCMT1204FN-NAJ				●		
	RCMT1606EN-MJ	●	●	●			
	RCMT1606EN-NMJ	●	●	●			
	RCMT1606FN-NAJ				●		
 -NMJ							
 -NAJ							

● RDCA2004TN, RDCN2004TN, RDKN2004...

Shape	Designation	Coated		Uncoated		Applicable mills
		AH120		UX30	TH10	
	RDCA2004TN			●		TRD6000 ERD6000
	RDCN2004TN			●		
	RDKN2004FN				●	
	RDKN2004TN	●		●		

● RDCM1203TN, RDMA1203TN

Shape	Designation	Uncoated		Applicable mills
		UX30		
	RDCM1203TN	●		ERD4000 (Former products)
	RDMA1203TN	●		

●: Line up





Insert

Milling Insert

Insert

● RDMT**ZDPN-MJ, RDMW**ZDSN

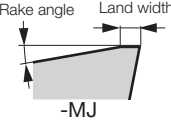
Shape	Designation	Coated					Uncoated		Applicable mills
		AH120	AH130	AH140	AH330	T3130	UX30		
   Rake angle Land width -MJ	RDMT1204ZDPN-MJ	●	●		●	●			TRD12/16... Page D159 ERD12... Page D160
	RDMW1204ZDSN	●							
	RDMT1606ZDPN-MJ	●	●	●	●	●	●		
	RDMW1606ZDSN	●							

● RDMW**M0

Shape	Designation	Coated								Applicable mills
		AH120								
	RDMW0501M0	●								EWD05/07/10... Page D162 HWD07... Page D162
	RDMW0702M0	●								
	RDMW1003M0	●								

● RFEN2004ZFTN, RFEN2004M0TN

Shape	Designation	Coated		Uncoated		Applicable mills
		AH120	GH330	UX30	KS20	
	RFEN2004ZFTN	●	●	●	●	TRF6000 ERF6000
	RFEN2004M0TN		●	●	●	

● RNGU1307ZNER-MJ, RNMU1307ZNER-MJ

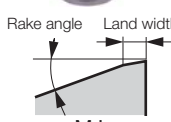
Shape	Designation	Coated				Applicable mills
		AH120	AH3135	T1215	T3225	
  Rake angle Land width -MJ	RNGU1307ZNER-MJ	●	●			DOTMILL TASN13... Page D098
	RNMU1307ZNER-MJ	●	●	●	●	

● : Line up

Milling Insert

● RPMT**EN-MJ, RPMT**EN-ML

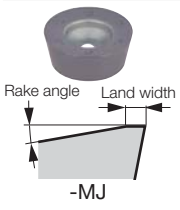
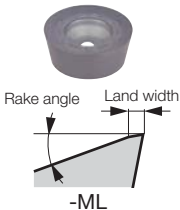
Shape	Designation	Coated								Applicable mills
		AH130	AH725	AH4035						
 <p>Rake angle Land width</p> <p>-MJ</p>  <p>Rake angle Land width</p> <p>-ML</p>	RPMT10T3EN-MJ	●	●	●						FIXRMILL TRP12/16... Page D150 ERP10/12/16... Page D150 HRP10/12... Page D151
	RPMT10T3EN-ML	●	●	●						
	RPMT1204EN-MJ	●	●	●						
	RPMT1204EN-ML	●	●	●						
	RPMT1606EN-MJ	●	●	●						
	RPMT1606EN-ML	●	●	●						

● SCMT**-23

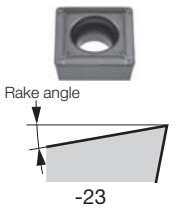
Shape	Designation	Coated								Applicable mills
		AH120								
 <p>Rake angle</p> <p>-23</p>	SCMT09T308-23	●								EBD... Page D166 HBD...
	SCMT120408-23	●								

● SDCN1504ZDSR, SDEN1504ZDSR, SDNN1504ZDSR

Shape	Designation	Coated								Applicable mills
		AH120	AH140	T1115	T3130					
	SDCN1504ZDSR	●	●		●					MILLFEED TXD15...
	SDEN1504ZDSR	●	●	●	●					
	SDNN1504ZDSR	●	●	●	●					

●: Line up



Insert

Milling Insert

Insert









● SDCN42HTR, SDKN42HTR

Shape	Designation	Coated								Applicable mills
		GH330								
	SDCN42HTR	●								EUD4600 (Former products)
	SDKN42HTR	●								

● SDKN42EF..., SDEN42EFTR24

Shape	Designation	Coated	Cermet	Uncoated		Applicable mills
		T3130	NS740	TH10	UX30	
	SDKN42EFTR	●	●			TMD4100I (Former products)
	SDKN42EFFR			●		
	SDEN42EFTR24		●		●	

● SDCN42Z..., SDEN42Z..., SDKN42Z..., SDCN42ZFN-DIA, SDKR42ZSR-MJ, SDMR1203AETN-MJ, SDKR1203AETN-MJ, SDKR42ZPN-MS

Shape	Designation	Coated						Cermet	Uncoated	PCD	Applicable mills			
		AH120	AH130	AH140	AH330	GH330	T1115	T3130	NS740	N308		UX30	TH10	DX140
	SDCN42ZFN										●			TMD4400RI-U Page D120
	SDCN42ZTN							●	●	●				
	SDCN42ZTN20							●						TMD4400RB-U Page D121
	SDEN42ZFN										●			
	SDEN42ZTN	●		●		●	●	●	●					EMD4400RI TGD4400-A
	SDEN42ZTNCR	●		●	●			●						
	SDEN42ZTN20							●						EGD4400 TFD4400-A
	SDKN42ZFN										●			
	SDKN42ZTN	●	●	●	●	●		●	●	●				
	SDKN42ZTNCR							●						
	SDKN42ZTN16							●						
	SDCN42ZFN-DIA											●		
	SDKR42ZSR-MJ	●			●	●		●						
	SDMR1203AETN-MJ							●						
	SDKR1203AETN-MJ							●						
	SDKR42ZPN-MS		●	●										

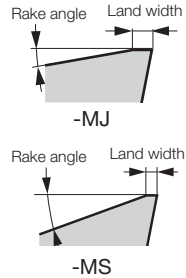

DX140: Packing quantity = 1pc.

●: Line up

Milling Insert









●SDCN53HTR, SDKN53HTR

Shape	Designation	Coated								Applicable mills
		GH330								
	SDCN53HTR	●								TUD5600 (Former products)
	SDKN53HTR	●								



Insert

● SDCN53ZTN, SDEN53Z..., SDKN53Z..., SDKR53ZSR-MJ

Shape	Designation	Coated					Cermet		Uncoated		Applicable mills
		AH120	AH130	AH140	GH330	T3130	NS740	N308	UX30	TH10	
        	SDCN53ZTN						●	●			TMD5400I-U Page D124
	SDEN53ZFN								●		
	SDEN53ZTN				●		●		●		
	SDEN53ZTNCR						●				
	SDEN53ZTN20					●					
	SDKN53ZFN									●	
	SDKN53ZTN	●	●	●	●		●	●	●		
	SDKN53ZTNCR						●				
	SDKN53ZTN16									●	
	SDKR53ZSR-MJ				●	●					

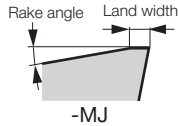

● SDMT050204PN-MJ, SDHT050204FN-AJ

Shape	Designation	Coated		Uncoated		Applicable mills
		AH140	AH725	TH10		
	SDMT050204PN-MJ	●	●			TUNGQUAD TPD05... Page D069 EPD05... Page D069 ELD05... Page D069
	SDHT050204FN-AJ			●		

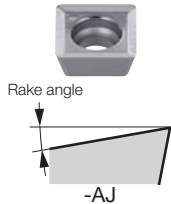
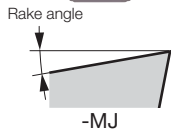

● : Line up



Milling Insert

- SDMT1204AFPN-MJ, SDMT1204AFTN-MJ, SDMT1204AFPN-ML, SDMT1204AFPN-MS, SDGT1204AFTN-MJ, SDGT1204AFFN-AJ

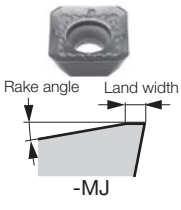
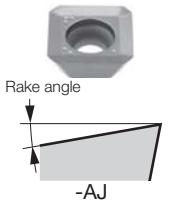
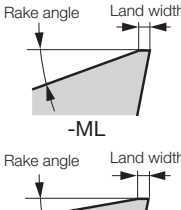
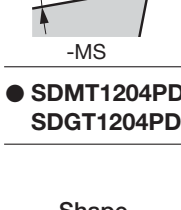
Insert

Shape	Designation	Coated					Cermet		Uncoated		Applicable mills
		AH120	AH140	AH330	GH330	T3130	NS740		TH10		
 <p>-MJ</p>	SDMT1204AFPN-MJ	●	●	●	●	●					TAD12... EAD12... (Former products)
	SDMT1204AFTN-MJ						●				
	SDMT1204AFPN-ML	●		●							
	SDMT1204AFPN-MS		●								
	SDGT1204AFTN-MJ	●		●			●				
	SDGT1204AFFN-AJ								●		
 <p>-AJ</p>											
	 <p>-ML</p>										
 <p>-MS</p>											

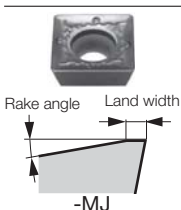
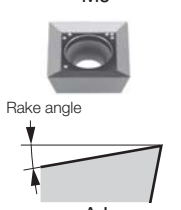
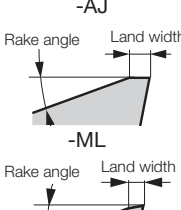
- SDMT1204PDSR-MJ, SDMT1204PDTR-MJ, SDMT1204PDPR-ML, SDMT1204PDPR-MS, SDGT1204PDTR-MJ, SDGT1204PDFR-AJ

Shape	Designation	Coated					Cermet		Uncoated		Applicable mills
		AH120	AH140	AH330	GH330	T3130	NS740		TH10		
 <p>-MJ</p>	SDMT1204PDSR-MJ	●	●	●	●	●					TPD12... EPD12... (Former products)
	SDMT1204PDTR-MJ						●				
	SDMT1204PDPR-ML	●		●							
	SDMT1204PDPR-MS		●								
	SDGT1204PDTR-MJ	●		●			●				
	SDGT1204PDFR-AJ								●		
 <p>-AJ</p>											
	 <p>-ML</p>										
 <p>-MS</p>											





●: Line up

Milling Insert

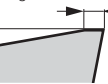

● SDMW090308TN, SDMW120408TN

Shape	Designation	Uncoated								Applicable mills
		UX30								
	SDMW090308TN	●								ELD3000
	SDMW120408TN	●								ELD4000 (Former products)

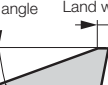
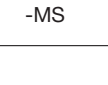
● SECN1203AGFN, SEEN1203AG..., SEKN1203AG..., SEKR1203AGSR-MJ, SEKR1203AGPN-MS

Shape	Designation	Coated							Cermet	Uncoated		Applicable mills
		AH120	AH130	AH140	AH330	GH330	T1115	T3130	NS740	UX30	TH10	
	SECN1203AGFN										●	TME4400R/LI TME4400RB EME4400
	SEEN1203AGFN										●	
	SEEN1203AGTN	●	●	●		●	●	●	●	●		
	SEEN1203AGTN-T							●	●	●		
	SEEN1203AGTNCR	●	●	●	●			●				
	SEEN1203AGTNCR-14							●				
	SEKN1203AGFN-T										●	
	SEKN1203AGTN	●	●	●	●	●	●	●	●	●		
	SEKN1203AGTN-T					●	●	●	●	●		
	SEKN1203AGTNCR							●				
	SEKR1203AGSR-MJ	●			●	●	●					
	SEKR1203AGPN-MS		●	●								

● SE*N1504AG..., SEKR1504AGSR-MJ

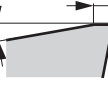

Shape	Designation	Coated				Cermet	Uncoated		Applicable mills
		AH120	AH140	GH330	T3130	NS740	TH10	UX30	
	SEEN1504AGTN					●		●	TME5400RI
	SEKN1504AGFN							●	
	SEKN1504AGTN	●	●	●	●	●		●	
	SEKN1504AGTN-T				●	●			
	SEKR1504AGSR-MJ			●	●				

●: Line up







Milling Insert

● SECN422TN, SECN422FN, SEEN422TN, SEEN422FN, SECN422FN-DIA

Shape	Designation	ISO Designation (Metric)	Cermet		Uncoated		PCD		Applicable mills
			NS740	N308	UX30	TH10	DX140		
	SECN422TN	SECN120308TN	●	●	●				EGE4000 (Former products)
	SECN422FN	SECN120308FN				●			
	SEEN422TN	SEEN120308TN	●	●	●				QHE4000
	SEEN422FN	SEEN120308FN				●			
	SECN422FN-DIA	SECN120308FN-D					●		
-DIA									

DX140: Packing quantity = 1pc.

● SEEN1203AFTNCR-14, SEKN42AFTN, SEKN42AFFN, SEKN42AFTN16, SEKR42AFSR-MJ, SEKR1203AFPN-MS, SEKR1203AFTN-MJ, SEMR1203AFTN-MJ

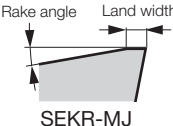
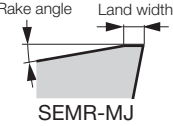
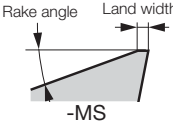
Shape	Designation	ISO Designation (Metric)	Coated					Cermet	Uncoated		Applicable mills
			AH120	AH130	AH140	GH330	T3130	NS740	TH10	UX30	
	SEEN1203AFTNCR-14							●			TGE4400I
	SEKN42AFTN	SEKN1203AFTN	●	●	●	●				●	EGE4400 (Former products)
	SEKN42AFFN	SEKN1203AFFN							●		
	SEKN42AFTN16	SEKN1203AFTN-16					●				
	SEKR42AFSR-MJ	SEKR1203AFSR-MJ				●	●				
	SEKR1203AFPN-MS				●						
	SEKR1203AFTN-MJ						●				
	SEMR1203AFTN-MJ						●				
	SEMR1203AFTN-MJ						●				
	SEKR-MJ										
	SEMR-MJ										
	SEKR-MJ										
	SEMR-MJ										
	SEKR-MJ										
	-MS										

●: Line up



Insert

Milling Insert

● SECN42EFTRCR, SEEN42EFTRCR, SEKN42EFTR, SEKN42EFFR

Shape	Designation	ISO Designation (Metric)	Coated		Cermet		Uncoated		Applicable mills
			GH330 T3130		NS740		UX30 TH10		
	SECN42EFTRCR	SECN1203EFTR			●				EGE4100 (Former products)
	SEEN42EFTRCR	SEEN1203EFTR			●				
	SEKN42EFTR	SEKN1203EFTR	●	●	●				
	SEKN42EFFR	SEKN1203EFFR					●		

● SE*N42ZFR, SECN42ZFR-DIA

Shape	Designation	Uncoated		PCD		Applicable mills
		TH10		DX140		
	SECN42ZFR-DIA			●		THE4000RIA
	SECN42ZFR	●				
	SEEN42ZFR	●				
 -DIA						

DX140: Packing quantity = 1pc.

●: Line up



Insert

Milling Insert

● SEGW12X4ZEFR, SEGW12X4ZEPR, SEGT12X4ZEFR-AJ, SEGW12X4ZEFR-D, SEGW12X4ZEFR-WD, SEGW12X4ZEFR-BD

Insert

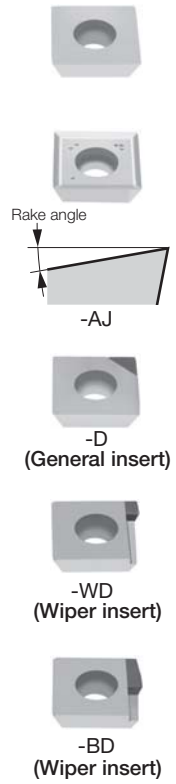
Shape	Designation	Coated			Cermet		Uncoated		PCD		Applicable mills
		AH120	AH140	DS1100	NS740		KS05F		DX140		
	SEGW12X4ZEFR								●		TFE12R... Page D114 EFE12RU... Page D114
	SEGW12X4ZEPR	●	●		●						
	SEGT12X4ZEFR-AJ			●					●		
	SEGW12X4ZEFR-D								●		
	SEGW12X4ZEFR-WD								●		
	SEGW12X4ZEFR-BD								●		

DX140: Packing quantity = 1pc.

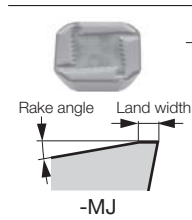

●SEKR1504AFSR-MJ

Shape	Designation	Coated							Applicable mills
		T3130							
	SEKR1504AFSR-MJ	●							(Former products)

●: Line up

Milling Insert

● SF*N42ZFN, SFCN42ZFN-DIA



Shape	Designation	Uncoated		PCD				Applicable mills
		TH10		DX140				
	SFCN42ZFN	●						THF4400RIA
	SFEN42ZFN	●						
	SFCN42ZFN-DIA			●				
 -DIA								

DX140: Packing quantity = 1pc.



Insert

● SF*N53ZFN, SFCN53ZFN-DIA

Shape	Designation	Uncoated		PCD				Applicable mills
		TH10		DX140				
	SFCN53ZFN	●						THF5400RIA
	SFEN53ZFN	●						
	SFCN53ZFN-DIA			●				
 -DIA								

DX140: Packing quantity = 1pc.

● SN**56FTR

Shape	Designation	Cermet						Applicable mills
		X407						
	SNA56FTR	●						MS...
	SNAG56FTR							
	SNCC56FTR							
	SNCJ56FTR							

●: Line up





Milling Insert

Insert



● SNCN43Z..., SNKF43Z..., SNKN43ZTN

Shape	Designation	Coated		Cermet		Ceramic	Uncoated		Applicable mills
		T1115	T3130	NS740	N308	FX105	UX30	TH10	
	SNCN43ZFN							●	TGN4200R-A
	SNCN43ZTN			●	●		●		
	SNKF43ZFN							●	
	SNKF43ZTN	●					●		
	SNKN43ZTN	●	●	●		●	●		

● SNMU1706ANPR-MJ, SNHU1706ANPR-MJ, SNMU1706ANTR-ML, SNHU1706ANTR-ML, SNHU1706ANFN-W

Shape	Designation	Coated					Applicable mills
		AH120	AH140	AH725	AH3135	T1215	
    	SNMU1706ANPR-MJ		●	●	●	●	DOOCTO DOQUAD TAN07... Page D101
	SNHU1706ANPR-MJ		●	●			
	SNMU1706ANTR-ML	●			●		
	SNHU1706ANTR-ML	●					
	SNHU1706ANFN-W	●					





● SNEN12**Z...

Shape	Designation	Uncoated		Applicable mills
		UX30	TH10	
 	SNEN12T2ZFN		●	SVN4000
	SNEN12T2ZTN	●		
	SNEN1233ZFN		●	
	SNEN1233ZTN	●		

● : Line up

Milling Insert

- SNGU1307ANEN-MJ, SNGU1307ANEN-W, SNGU1307ANEN-MH, SNGU1307C14ANEN-MJ, SNMU1307ANEN-MJ

Shape	Designation	Coated				Applicable mills
		AH120	AH3135	T3225	T1215	
    	SNGU1307ANEN-MJ	●	●	●		DOTMILL TASN13... Page D098
	SNGU1307ANEN-W	●	●			
	SNGU1307ANEN-MH			●		
	SNGU1307C14ANEN-MJ	●	●			
	SNMU1307ANEN-MJ	●	●	●	●	



Insert

- SNMN1204**TN

Shape	Designation	Coated		Ceramic	Uncoated	Applicable mills
		AH120	T1115	T3130	FX105	
	SNMN120408TN				●	TGN4200R-A
	SNMN120412TN	●	●	●	●	
	SNMN120416TN				●	
	SNMN120420TN				●	
	SNMN120424TN				●	

●: Line up

Milling Insert

● SPCN42..., SPEN42..., SPKN42..., SPKR42SSR-MJ, SPGN120312TN

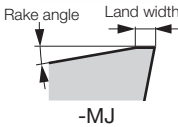
Shape	Designation	Coated					Cermet		Ceramic	Uncoated		Applicable mills		
		AH120	AH140	GH330	T1115	T3130	NS740	N308	FX105	UX30	TH10			
	SPCN42STR						●	●			●		TGP4100RIA/BA	
	SPCN42SFR											●		
	SPEN42STR						●							
	SPKN42STR	●	●	●	●	●	●	●	●	●	●			
	SPKN42STL						●				●			
	SPKN42SFR											●		
	SPKN42SFL											●		
	SPKR42SSR-MJ			●	●	●								
	SPGN120312TN								●					
	SPEN423TN					●	●				●			
	SPEN423FN											●		

● SP*N42...

Shape	Designation	Coated		Cermet			Uncoated		Applicable mills
		T1115	T3130	NS740	X407	N308	UX30	TH10	
	SPAN42ZFR							●	TGP4200R-A
	SPCN42ZFL							●	
	SPCN42ZFR							●	
	SPCN42ZTR			●	●	●			
	SPEN423TN		●	●			●		
	SPEN423FN							●	
	SPEN42ZTR			●					
	SPKN42ZFL							●	
	SPKN42ZFR							●	
	SPKN42ZTR	●	●	●	●	●	●		

●: Line up

Milling Insert

● SP*N53S..., SPKR53SSR-MJ

Shape	Designation	Coated			Cermet		Uncoated		Applicable mills
		GH330	T1115	T3130	NS740	N308	UX30	TH10	
 <p>Rake angle Land width -MJ</p>	SPCN53SFR								TGP5100RIA
	SPCN53STR					●	●		
	SPKN53SFR							●	
	SPKN53STL						●		
	SPKN53STR	●	●		●		●		
	SPKN53STR20			●					
	SPKR53SSR-MJ	●		●					

● SPGN120412TN

Shape	Designation	Coated		Ceramic		Applicable mills
		T1115		FX105		
	SPGN120412TN	●		●		QFP4000 (Former products)

● SPHA**FNW

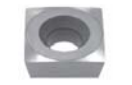
Shape	Designation	Cermet		Uncoated		Applicable mills
		N308		TH10		
	SPHA431FNW	●		●		TFP4000IA
	SPHA435FNW	●		●		TFD4400-A SFP4000R EFP4000R

●: Line up



Insert

Milling Insert

Insert

● SPMA422...

Shape	Designation	Cermet		Uncoated		Applicable mills
		NS740		UX30	TH10	
	SPMA422TN	●		●		ECP4400R Page D208
	SPMA422FN			●		

● SPMP..., SPMM**ERD

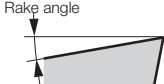
Shape	Designation	Coated		Applicable mills
		T313W		
 	SPMP831DS	●		TCB... Page D209
	SPMP042ERD	●		
	SPMM322ERD	●		
	SPMM432ERD	●		

● SPMR1605PPTR-MJ, SPMR1605PPPR-ML, SPMR1605PPTR-MH

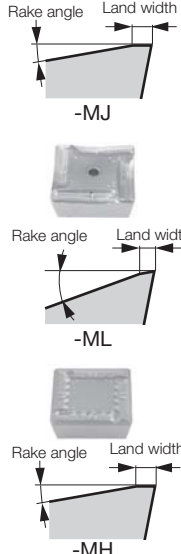
Shape	Designation	Coated			Uncoated		Applicable mills
		GH330	T1115	T3130	UX30		
 	SPMR1605PPTR-MJ	●	●	●	●	TPP16...	
	SPMR1605PPPR-ML	●					
	SPMR1605PPTR-MH	●		●	●		



● : Line up

Milling Insert

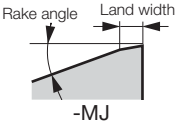
● SQMU1206ZSR-MJ

Shape	Designation	Coated				Applicable mills
		AH120	AH130	AH725	T3130	
  -MJ	SQMU1206ZSR-MJ	●	●	●	●	DOFEEDQUAD TXQ... Page D021

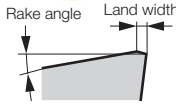
● SSM..., SSS...

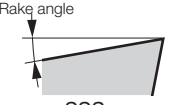
Shape	Designation	Coated				Applicable mills
		GH130				
  SSM	SSM22N	●				TUNGALLOY S/ASG... Page D128
	SSM31N	●				
	SSM41N	●				
	SSS16N	●				
	SSS22N	●				
	SSS31N	●				
	SSS41N	●				
  SSS						

●: Line up









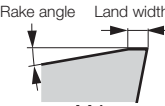

Insert

Milling Insert

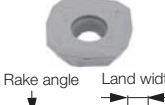
● SWMT13T3AFPR-MJ, SWMT13T3AFER-ML, SWMW13T3AFTR, SWMT13T3AFPR-HJ,
SWMT13T3AFPR-MS, SWGT13T3AFPR-MJ, SWGT13T3AFFR-AJ

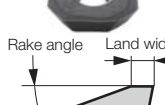

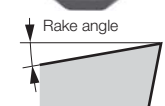

Insert

Shape	Designation	Coated								Cermet	Uncoated	Applicable mills
		AH120	AH130	AH140	AH3135	T1115	T1215	T3130	DS1100	NS740	KS05F	
	SWMT13T3AFPR-MJ	●	●	●	●	●	●	●		●		TUNG MILL TAW13... Page D109 EAW13... Page D110
	SWMT13T3AFER-ML	●	●									
	SWMW13T3AFTR	●				●	●	●		●		
	SWMT13T3AFPR-HJ	●	●	●		●	●	●				
	SWMT13T3AFPR-MS		●	●	●							
	SWGT13T3AFPR-MJ	●								●		
	SWGT13T3AFFR-AJ							●			●	
												
	SWMW13T3AFTR											
												
												
												
												
												
												

●: Line up

Milling Insert

● SWMT1304PDPR-MJ, SWMT1304PDER-ML, SWMT1304PDPR-MS, SWGT1304PDPR-MJ, SWGT1304PDFR-AJ

Shape	Designation	Coated							Cermet	Uncoated	Applicable mills	
		AH120	AH130	AH140	T1115	T1215	T3130	DS1100	NS740	KS05F		
 Rake angle Land width -MJ	SWMT1304PDPR-MJ	●	●	●	●	●	●	●			TUNG MILL TPW13... Page D072 EPW13... Page D073	
	SWMT1304PDER-ML	●	●									
	SWMT1304PDPR-MS		●	●								
	SWGT1304PDPR-MJ	●							●			
	SWGT1304PDFR-AJ							●		●		
 Rake angle Land width -ML												
 Rake angle Land width -MS												
 Rake angle -AJ												

● SWMT1506ZER-MJ

Shape	Designation	Coated									Applicable mills	
		AH120	AH3135									
 Rake angle Land width -MJ	SWMT1506ZER-MJ	●	●									MILL Q FEED TXSW... Page D024

●: Line up

Insert



Milling Insert

Insert

● T*-R...

Shape	Designation	Coated							Applicable mills
		GH330							
	T1-R14	●							Single tooth threading mills Page D211
	T1-R28	●							
	T2-R14	●							
	T2-R28	●							

● TCGT160608PDER-MJ, TCMT160620PDER-NMJ

Shape	Designation	Coated							Applicable mills
		AH120	AH3135						
  <p>Rake angle Land width</p> <p>-MJ</p> <p>-NMJ</p>	TCGT160608PDER-MJ	●	●						TUNG-TRISHRED LPTC16... Page D048 TPTC16... Page D047 EPTC16... Page D047
	TCMT160620PDER-NMJ	●	●						



● TDMN**N

Shape	Designation	Cermet		Uncoated		Applicable mills
		NS740		TH10	UX30	
	TDMN110304TN	●			●	ESD2000 (Former products)
	TDMN110304FN			●		
	TDMN110308TN	●			●	

●: Line up

Milling Insert

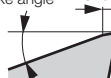

● TECN32..., TEEN32..., TECN32ZFR-DIA, TEKR1603PEPR-MS

Shape	Designation	Coated							Cermet		Uncoated		PCD		Applicable mills
		AH120	AH130	AH140	AH330	GH330	T1115	T3130	NS740	N308	UX30	TH10	DX140		
	TECN32ZFR										●				TSE3000R ESE3000R
	TECN32ZTR							●	●	●					
	TEEN32ZFR										●				
	TEEN32ZTR	●	●	●	●	●	●	●	●	●					
	TECN32ZFR-DIA											●			
	TEKR1603PEPR-MS			●											
	-MS														



DX140: Packing quantity = 1pc.

● TECN43..., TEEN43..., TECN43ZFR-DIA, TEKR2204PEPR-MS

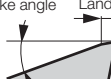
Shape	Designation	Coated							Cermet		Uncoated		PCD		Applicable mills
		AH120	AH130	AH140	AH330	GH330	T1115	T3130	NS740	N308	UX30	TH10	DX140		
	TECN43ZFR										●				TSE4000RIAU Page D092 ESE4000R
	TECN43ZTR							●	●						
	TEEN43ZFR										●				
	TEEN43ZTR	●	●	●	●	●	●	●	●	●					
	TECN43ZFR-DIA											●			
	TEKR2204PEPR-MS			●											
	-MS														

DX140: Packing quantity = 1pc.

●: Line up

Milling Insert

● TNGU120708PER-MJ, TNGU120708PER-NMJ, TNMU1207R16PER-MJ, TNMU120708PER-MJ, TNMU120708PER-NMJ

Insert

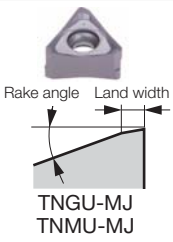
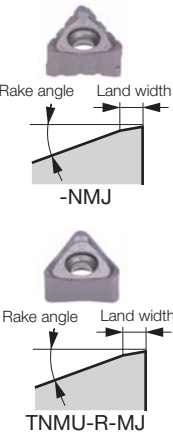
Shape	Designation	Coated				Applicable mills
		AH120	AH3135	T1215	T3225	
 <p>TNGU-MJ TNMU-MJ</p>	TNGU120708PER-MJ	●	●			DOFTRI TPTN12... Page D034 EPTN12... Page D034
	TNGU120708PER-NMJ	●	●			
	TNMU1207R16PER-MJ	●	●			
	TNMU120708PER-MJ	●	●	●	●	
	TNMU120708PER-NMJ	●	●			
 <p>-NMJ</p> <p>TNMU-R-MJ</p>						

● TNKF64ZTR

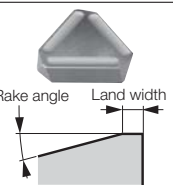
Shape	Designation	Uncoated				Applicable mills
		UX30				
	TNKF64ZTR	●				TPN64001 (Former products)





●: Line up

Milling Insert

●TNMN43ZENS

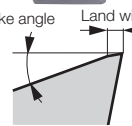
Shape	Designation	Uncoated							Applicable mills
		UX30							
	TNMN43ZENS	●							TSN4000 ESN4000 (Former products)

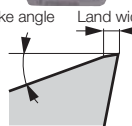
● TOMT**PDER-MJ, TOMT150608PDER-NMJ

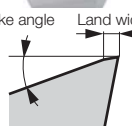
Shape	Designation	Coated				Uncoated			Applicable mills
		AH120	AH3135	T1215	KS05F				
 Rake angle Land width  -MJ	TOMT060302PDER-MJ	●	●						TUNG-TRI TPA06... Page D038 EPA06... Page D038 HPA06... Page D039 TPA10... Page D039 TLA10... Page D041 EPA10... Page D040 HPA10... Page D040 TPA15... Page D041 TLA15... Page D042 EPA15... Page D042
	TOMT060304PDER-MJ	●	●						
	TOMT060308PDER-MJ	●	●	●					
	TOMT100404PDER-MJ	●	●						
	TOMT100408PDER-MJ	●	●	●					
	TOMT100416PDER-MJ	●	●						
	TOMT150604PDER-MJ	●	●						
	TOMT150608PDER-MJ	●	●	●					
	TOMT150616PDER-MJ	●	●						
	TOMT150620PDER-MJ	●	●						
 Rake angle Land width  -NMJ	TOMT150608PDER-NMJ	●	●						
	TOGT100404PDFR-AJ				●				
	TOGT100408PDFR-AJ				●				
	TOGT150604PDFR-AJ				●				
 Rake angle Land width  -AJ	TOGT150608PDFR-AJ				●				

● TPCA43ZTRW1, TPMA432TNW1

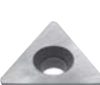
Shape	Designation	Cermet		Uncoated		Applicable mills
		NS740		UX30	TH10	
	TPCA43ZTRW1				●	PES1500...
	TPMA432TNW1	●		●	●	

●: Line up



Milling Insert

● TP*N43Z..., TPKR43ZSR-MJ, TPKR2204PDSR-MJ

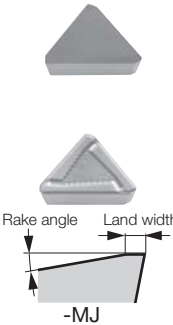
Shape	Designation	Coated						Cermet		Uncoated		Applicable mills
		AH120	AH130	AH140	GH330	T1115	T3130	NS740	N308	UX30	TH10	
	TPCN43ZFR									●		TSP4000RIA-U Page D094 TFP4000IA
	TPCN43ZTR						●	●	●			
	TPEN43ZTR							●				
	TPEN43ZTRCR											
	TPKN43ZFR										●	
	TPKN43ZTR	●	●	●	●	●	●	●	●	●		
	TPKR43ZSR-MJ				●	●						
	TPMR2204PDSR-MJ				●	●						
	TPKN43ZFL										●	

● TPMN**TN

Shape	Designation	Cermet								Applicable mills
		NS740								
	TPMN110304TN	●								(Former products)
	TPMN110308TN	●								
	TPMN160308TN	●								
	TPMN160312TN	●								
	TPMN220408TN	●								
	TPMN220412TN	●								

● TVKX**TN-MJ

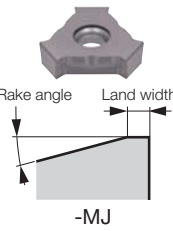
Shape	Designation	Coated											Applicable mills
		AH120	AH130	AH725									
	TVKX020202TN-MJ	●		●									TUNG TÖLIT ASV 02/03/04/05... Page D131
	TVKX020204TN-MJ	●		●									
	TVKX03X302TN-MJ	●		●									
	TVKX03X304TN-MJ	●		●									
	TVKX04H304TN-MJ	●	●	●									
	TVKX04H308TN-MJ	●	●	●									
	TVKX050404TN-MJ	●	●	●									
	TVKX050408TN-MJ	●	●	●									

● : Line up

Milling Insert

● WCMT**-D4

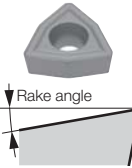
Shape	Designation	Coated								Applicable mills
		AH120	AH140							
	WCMT050308-D4	●	●							EVX... Page D203 HVX...
	WCMT06T308-D4	●	●							

● WDCN42ZFR-DIA

Shape	Designation	PCD								Applicable mills
		DX140								
 Wiper insert -DIA	WDCN42ZFR-DIA	●								TMD4400RI-U Page D120 TMD4400RB-U Page D121 EMD4400RI EGD4400

DX140: Packing quantity = 1pc.

● WECN42ZFR-DIA

Shape	Designation	PCD								Applicable mills
		DX140								
 Wiper insert -DIA	WECN42ZFR-DIA	●								THE4000RIA

DX140: Packing quantity = 1pc.

● WFCN**ZFR-DIA

Shape	Designation	PCD								Applicable mills
		DX140								
 Wiper insert -DIA	WFCN42ZFR-DIA	●								THF4400RIA
	WFCN53ZFR-DIA	●								THF5400RIA

DX140: Packing quantity = 1pc.

●: Line up



Insert

Milling Insert

Insert

● WNGU**TN-MJ

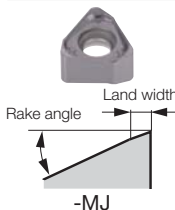
Shape	Designation	Coated								Applicable mills
		AH120	AH130	AH725						
 <p>Rake angle Land width -MJ</p>	WNGU060308TN-MJ	●	●	●						TUNGUSLOT ASW 06/07/09... Page D133 TSW 06/07/09... Page D134
	WNGU060316TN-MJ	●	●	●						
	WNGU07T308TN-MJ	●	●	●						
	WNGU07T316TN-MJ	●	●	●						
	WNGU090408TN-MJ	●	●	●						
	WNGU090416TN-MJ	●	●	●						

● WPAN42SFR

Shape	Designation	Cermet		Uncoated						Applicable mills
		N308		TH10						
 <p>Wiper insert (Two corner type)</p>	WPAN42SFR	●		●						TGP4100RIA/BA

● WPAN42SFRS

Shape	Designation	Uncoated								Applicable mills
		TH10								
 <p>Wiper insert (One corner type)</p>	WPAN42SFRS	●								TGP4100RIA/BA





● WPAN42ZFR

Shape	Designation	Uncoated								Applicable mills
		TH10								
 <p>Wiper insert (Two corner type)</p>	WPAN42ZFR	●								TGP4200R-A

● : Line up

Milling Insert

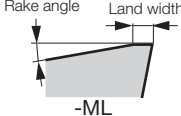

● WPMT**ZPR..., WPMT**ZPR-ML, WPMT**-MH, WPMT**-DML, WPMW**-ZPR

Shape	Designation	Coated						Applicable mills
		AH120	AH130	AH140	AH730	AH330	T3130	
	WPMW05H315ZPR	●		●				MILLFEED TXP05/06/08/09... Page D026
	WPMT05H315ZPR-ML	●		●				
	WPMT05H315ZPR-MH	●		●				
	WPMT05H315ZPR-DML				●			EXP05/06/09... Page D027 HXP...
	WPMW06X415ZPR	●		●			●	
	WPMT06X415ZPR-ML	●	●	●			●	
 -ML	WPMT06X415ZPR-MH	●		●				
	WPMT06X415ZPR-DML				●			
	WPMT080615ZSR	●	●	●		●	●	
 -MH	WPMT080615ZPR-ML	●	●	●			●	
	WPMT080615ZSR-MH	●		●				
	WPMT080615ZPR-DML				●			
 -DML	WPMT090725ZSR	●		●			●	
	WPMT090725ZPR-ML	●	●	●			●	
	WPMT090725ZSR-MH	●	●	●				
	WPMT090725ZPR-DML				●			

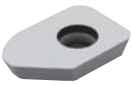

Insert

● WWCW13T3AFER-WS, WWCW13T3AFFR-WS, WWCW13T3AFFR-WD

Shape	Designation	Coated		Cermet	Uncoated	PCD	Applicable mills
		GH110	DS1100	NS740	KS05F	DX140	
	WWCW13T3AFER-WS	●		●			TUNG MILL TAW13... Page D109
	WWCW13T3AFFR-WS		●		●		
	WWCW13T3AFFR-WD					●	
 -WD							EAW13... Page D110

DX140: Packing quantity = 1pc.

●: Line up

Milling Insert

Insert

● WXHU**R-MJ

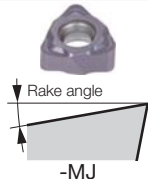
Shape	Designation	Coated							Applicable mills
		AH110							
	WXHU040305R-MJ	●							DOMMILL HFWX04... Page D148
	WXHU040310R-MJ	●							

● XCET310404ER

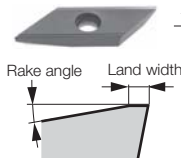
Shape	Designation	Coated	Cermet	Uncoated					Applicable mills
		AH330	NS740	UX30	TH10				
	XCET310404ER	●	●	●	●				ECC31... Page D206

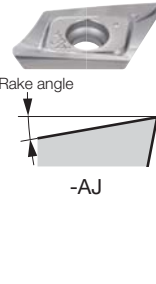

● XVCT16**R-AJ

Shape	Designation	Uncoated							Applicable mills
		TH10							
	XVCT160504R-AJ	●							TUNG-ALUMILL TPV16... Page D081 EPV16... Page D081
	XVCT160508R-AJ	●							
	XVCT160512R-AJ	●							
	XVCT160516R-AJ	●							
	XVCT160520R-AJ	●							
	XVCT160524R-AJ	●							
	XVCT160530R-AJ	●							
	XVCT160532R-AJ	●							
	XVCT160540R-AJ	●							
	XVCT160550R-AJ	●							

●: Line up

Milling Insert

● XVTG**EC-MJ, XVTG**FP-MJ, XVTG**FC-AJ, XVTG**FP-AJ

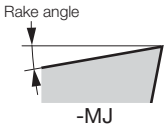
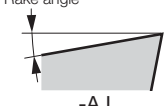
Shape	Designation	Coated							Applicable mills
		AH730	DS1200						
 Center edge insert	XVGT06H205EC-MJ	●							HYBRIDTACMILL EVH... Page D200
	XVGT08X305EC-MJ	●							
	XVGT09X405EC-MJ	●							
	XVGT06H205EP-MJ	●							
	XVGT07X305EP-MJ	●							
	XVGT09X405EP-MJ	●							
 Peripheral edge insert	XVGT06H205FC-AJ		●						
	XVGT07X305FC-AJ		●						
	XVGT08X305FC-AJ		●						
	XVGT09X405FC-AJ		●						
	XVGT06H205FP-AJ		●						
	XVGT07X305FP-AJ		●						
 Rake angle -MJ	XVGT09X405FP-AJ		●						
	XVGT09X405FP-AJ		●						
 Rake angle -AJ									

●: Line up



Insert

Milling Insert

● XHGR**ER-MJ, XHGR**FR-AJ





Insert

Shape	Designation	Coated							Applicable mills	
		AH730	DS1200							
<p>Rake angle</p> <p>-MJ</p>	XHGR110202ER-MJ	●							HYBRIDTACMILL EPH11/13/18... Page D084	
	XHGR110204ER-MJ	●								
	XHGR110205ER-MJ	●								
	XHGR110208ER-MJ	●								
	XHGR110210ER-MJ	●								
	XHGR110212ER-MJ	●								
	XHGR110215ER-MJ	●								
	XHGR110216ER-MJ	●								
	XHGR110220ER-MJ	●								
	<p>Rake angle</p> <p>-AJ</p>	XHGR130202ER-MJ	●							
		XHGR130204ER-MJ	●							
		XHGR130205ER-MJ	●							
		XHGR130208ER-MJ	●							
		XHGR130210ER-MJ	●							
		XHGR130212ER-MJ	●							
		XHGR130215ER-MJ	●							
		XHGR130216ER-MJ	●							
		XHGR130220ER-MJ	●							
		XHGR18T202ER-MJ	●							
		XHGR18T204ER-MJ	●							
		XHGR18T205ER-MJ	●							
		XHGR18T208ER-MJ	●							
		XHGR18T210ER-MJ	●							
		XHGR18T212ER-MJ	●							
		XHGR18T215ER-MJ	●							
		XHGR18T216ER-MJ	●							
		XHGR18T220ER-MJ	●							
XHGR110200FR-AJ		●								
XHGR110202FR-AJ		●								
XHGR110204FR-AJ		●								
XHGR110205FR-AJ		●								
XHGR110208FR-AJ		●								
XHGR110210FR-AJ		●								
XHGR110212FR-AJ		●								
XHGR110215FR-AJ		●								
XHGR110216FR-AJ		●								
XHGR110220FR-AJ		●								
XHGR130200FR-AJ		●								
XHGR130202FR-AJ		●								
XHGR130204FR-AJ		●								
XHGR130205FR-AJ		●								
XHGR130208FR-AJ		●								
XHGR130210FR-AJ		●								
XHGR130212FR-AJ		●								
XHGR130215FR-AJ		●								
XHGR130216FR-AJ		●								
XHGR130220FR-AJ		●								
XHGR18T200FR-AJ		●								
XHGR18T202FR-AJ		●								
XHGR18T204FR-AJ		●								
XHGR18T205FR-AJ		●								
XHGR18T208FR-AJ		●								
XHGR18T210FR-AJ		●								
XHGR18T212FR-AJ		●								
XHGR18T215FR-AJ		●								
XHGR18T216FR-AJ		●								
XHGR18T220FR-AJ		●								

● : Line up

Milling Insert

● XXGT**EC-MJ, XXGT**EP-MJ, XXGT**FC-AJ, XXGT**FP-AJ

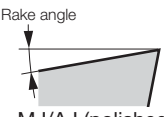
Shape	Designation	Coated							Applicable mills
		AH730	DS1200						
 Center edge insert  Peripheral edge insert  Rake angle -MJ/AJ (polished)	XXGT06H205EC-MJ	●							HYBRIDTACMILL EXH... Page D004
	XXGT07X305EC-MJ	●							
	XXGT09X408EC-MJ	●							
	XXGT06H205FC-AJ		●						
	XXGT07X305FC-AJ		●						
	XXGT09X408FC-AJ		●						
	XXGT06H205EP-MJ	●							
	XXGT07X305EP-MJ	●							
	XXGT09X408EP-MJ	●							
	XXGT06H205FP-AJ		●						
	XXGT07X305FP-AJ		●						
	XXGT09X408FP-AJ		●						

● XXMU**PR-MJ

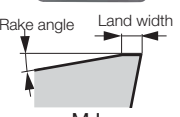
Shape	Designation	Coated							Applicable mills
		AH120	AH140						
  Rake angle Land width -MJ	XXMU08T204PR-MJ	●	●						EVX... Page D203 HVX...
	XXMU10H308PR-MJ	●	●						
	XXMU12X408PR-MJ	●	●						
	XXMU16X508PR-MJ	●	●						



●: Line up



Milling Insert



Insert

● YDEN0905PDFR-D, YDEN0905PDFR-WD, YDEN0905PDFR-BD

Shape	Designation	PCD							Applicable mills
		DX140							
 General insert	YDEN0905PDFR-D	●							DPD09... Page D117 EDPD09... Page D117
	YDEN0905PDFR-WD	●							
	YDEN0905PDFR-BD	●							
 Wiper insert									
 Wiper insert									



DX140: Packing quantity = 1pc.

● YDEN1505ADFR-D, YDEN1505ADFR-WD

Shape	Designation	PCD							Applicable mills
		DX140							
 General insert	YDEN1505ADFR-D	●							DAD15...
	YDEN1505ADFR-WD	●							
 Wiper insert									

DX140: Packing quantity = 1pc.

● YDEN1505PDFR-D, YDEN1505PDFR-WD



Shape	Designation	PCD							Applicable mills
		DX140							
 General insert	YDEN1505PDFR-D	●							DPD15... EDPD15...
	YDEN1505PDFR-WD	●							
 Wiper insert									

DX140: Packing quantity = 1pc.

●: Line up

Milling Insert

● YDEN2405PDFR-D, YDEN2405PDFR-WD, YDEN2405PDFR-BD

Shape	Designation	PCD							Applicable mills
		DX140							
 General insert	YDEN2405PDFR-D	●							DPD24...
	YDEN2405PDFR-WD	●							
	YDEN2405PDFR-BD	●							
 Wiper insert									
 Wiper insert									

DX140: Packing quantity = 1pc.

● YPEN1505PPTR-Q

Shape	Designation	T-CBN							Applicable mills
		BX950							
	YPEN1505PPTR-Q	●							QPP15...

BX950: Packing quantity = 1pc.

● ZDCA**TN

Shape	Designation	Uncoated							Applicable mills
		UX30							
	ZDCA0804TN	●							TBF1000 (Former products)
	ZDCA1105TN	●							

●: Line up



Insert

Milling Insert

Insert

● ZDMT**-MJ

Shape	Designation	Coated							Applicable mills
		AH120							
 Rake angle Land width -MJ	ZDMT4005-MJ	●							EBD... Page D166 HBD...
	ZDMT5006-MJ	●							

● ZFBM**-MJ, ZFRM**-MJ

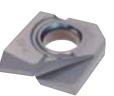
Shape	Designation	Coated									Applicable mills
		AH710	AH725								
 Rake angle ZFBM-MJ	ZFBM080R00-MJ	●	●								BALL NOSE EBFM... HBFM... Page D143
	ZFBM100R00-MJ	●	●								
	ZFBM120R00-MJ	●	●								
	ZFBM160R00-MJ	●	●								
	ZFBM200R00-MJ	●	●								
 Rake angle ZFRM-MJ	ZFBM250R00-MJ	●	●								
	ZFBM300R00-MJ	●	●								
	ZFBM320R00-MJ	●	●								
	ZFRM120R05-MJ	●	●								
	ZFRM120R10-MJ	●	●								
	ZFRM160R05-MJ	●	●								
	ZFRM160R10-MJ	●	●								
ZFRM160R15-MJ	●	●									
ZFRM200R10-MJ	●	●									
ZFRM200R15-MJ	●	●									

●: Line up

Milling Insert

● ZFBU**-MJ, ZFBU**-ML, ZFRU**-MJ

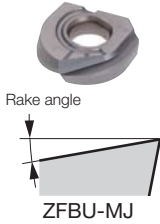
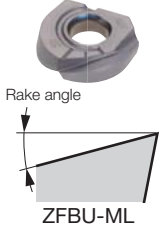
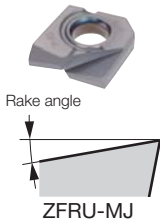
Shape	Designation	Coated						Applicable mills
		AH725						
 <p>Rake angle</p> <p>ZFBU-MJ</p>	ZFBU037R00-MJ	●						BALLFNÖSE EBFU... Page D142
	ZFBU050R00-MJ	●						
	ZFBU062R00-MJ	●						
	ZFBU075R00-MJ	●						
	ZFBU062R00-MJ	●						
	ZFBU100R00-MJ	●						
	ZFBU075R00-MJ	●						
	ZFBU125R00-MJ	●						
	ZFBU037R00-ML	●						
	ZFBU050R00-ML	●						
 <p>Rake angle</p> <p>ZFBU-ML</p>	ZFBU062R00-ML	●						
	ZFBU075R00-ML	●						
	ZFBU100R00-ML	●						
	ZFBU125R00-ML	●						
	ZFRU037R003-MJ	●						
	ZFRU050R003-MJ	●						
	ZFRU050R006-MJ	●						
	ZFRU050R012-MJ	●						
	ZFRU062R003-MJ	●						
	ZFRU062R006-MJ	●						
 <p>Rake angle</p> <p>ZFRU-MJ</p>	ZFRU062R012-MJ	●						
	ZFRU075R003-MJ	●						
	ZFRU075R006-MJ	●						
	ZFRU075R012-MJ	●						
	ZFRU100R003-MJ	●						
	ZFRU100R006-MJ	●						
	ZFRU100R012-MJ	●						
	ZFRU125R003-MJ	●						
	ZFRU125R006-MJ	●						
	ZFRU125R012-MJ	●						

●: Line up



Insert

Milling Insert

Insert

● ZNCA**FN, ZNMM**EN

Shape	Designation	Uncoated							Applicable mills
		UX30	TH10						
	ZNCA1002FN2	●	●						TBN1000
	ZNCA1203FN	●	●						
	ZNCA1603FN	●	●						
	ZNCA2004FN	●	●						
	ZNCA2505FN	●	●						
	ZNCA3005FN	●	●						
	ZNMM2004EN	●							
	ZNMM2505EN	●							
	ZNMM3005EN	●							

● ZPET**-MJ

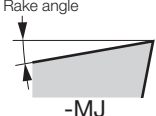
Shape	Designation	Coated							Applicable mills
		AH120	AH330						
 	ZPET075-MJ	●	●						EBP... Page D164 HBP...
	ZPET100-MJ	●	●						
	ZPET125-MJ	●	●						

● ZPCW**-QBN

Shape	Designation	T-CBN							Applicable mills
		BX950							
	ZPCW2003-QBN	●							EBB...
	ZPCW25H3-QBN	●							
	ZPCW30T3-QBN	●							
	ZPCW4004-QBN	●							
	ZPCW5004-QBN	●							

BX950: Packing quantity = 1pc.



●: Line up

Milling Insert CBN

● 2QP-SNGN..

Shape	Designation	CBN							Applicable mills
		BX910							
	2QP-SNGN090308	●							
	2QP-SNGN090312	●							

● 2QP-SPGW..., 2QP-SPGN...

Shape	Designation	CBN							Applicable mills
		BX910							
	2QP-SPGW09T308	●							
	2QP-SPGW09T312	●							
	2QP-SPGW120408	●							
	2QP-SPGW120412	●							
	2QP-SPGW120416	●							
	2QP-SPGN090308	●							
	2QP-SPGN090312	●							

● 3QP-TPGW..., 3QP-TPGN...

Shape	Designation	CBN							Applicable mills
		BX910							
	3QP-TPGW110308	●							
	3QP-TPGN110308	●							
	3QP-TPGN110312	●							

●: Line up







Insert

Milling Insert CBN

● S-CNGN..., S-RNGN..., S-SNGN..., S-TNGN...



Insert

Shape	Designation	CBN						Applicable mills
		BXC90						
	S-CNGN090308	●						
	S-CNGN090312	●						
	S-CNGN120408	●						
	S-CNGN120412	●						
	S-RNGN090300	●						
	S-RNGN120400	●						
	S-SNGN090308	●						
	S-SNGN090312	●						
	S-SNGN120308	●						
	S-SNGN120312	●						
	S-SNGN120408	●						
	S-SNGN120412	●						
	S-TNGN110308	●						
	S-TNGN110312	●						
	S-TNGN160408	●						
	S-TNGN160412	●						

●: Line up

MEMO

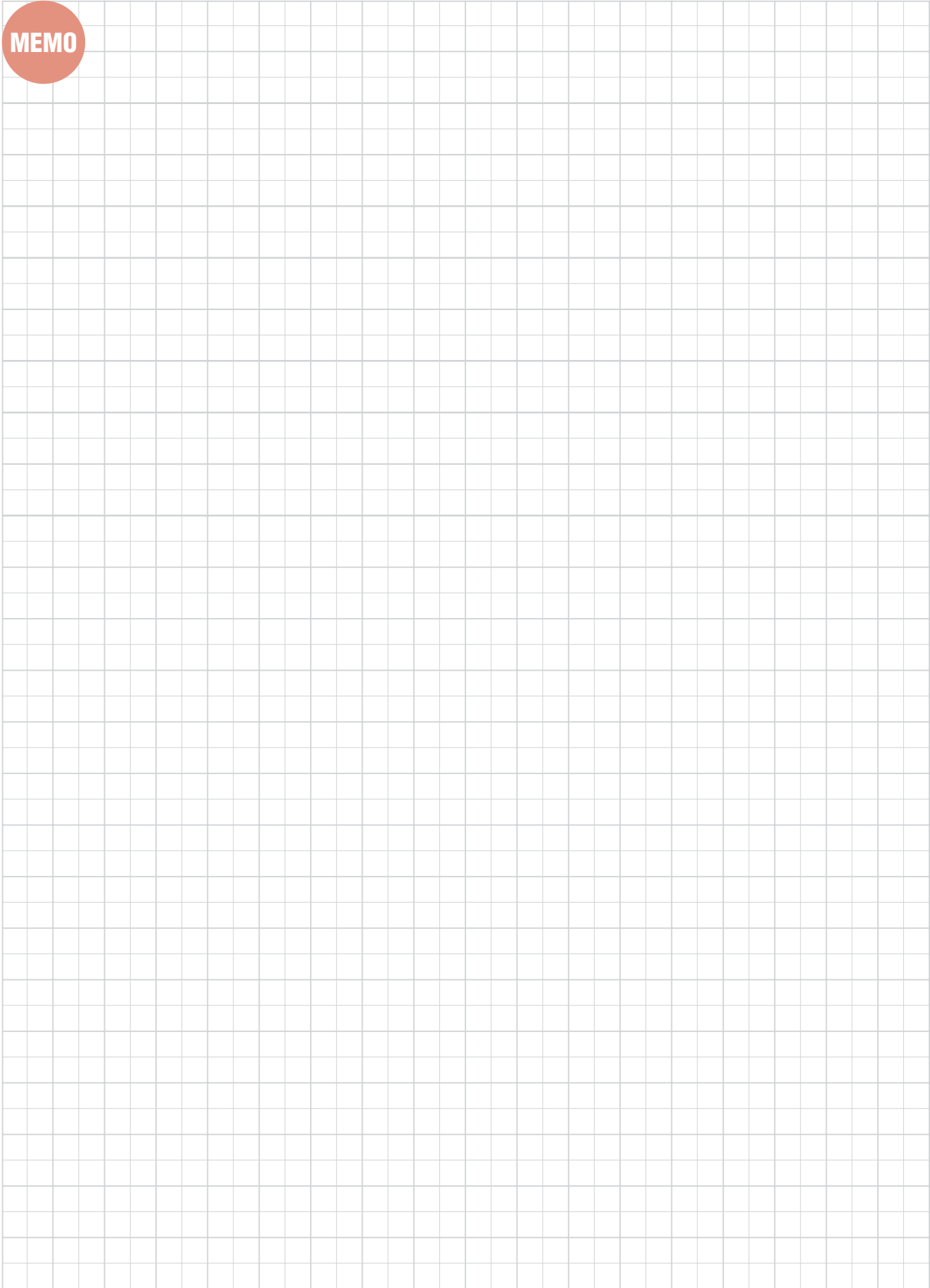

Insert

DrillLine



DRILLING



2 Effective Drill

E004



Indexable Drill

E066



Deep Hole Drill

E096

Basic Selection of Drilling Tools

Application ranges of drilling tools

Indexable & Head-Changeable Drills

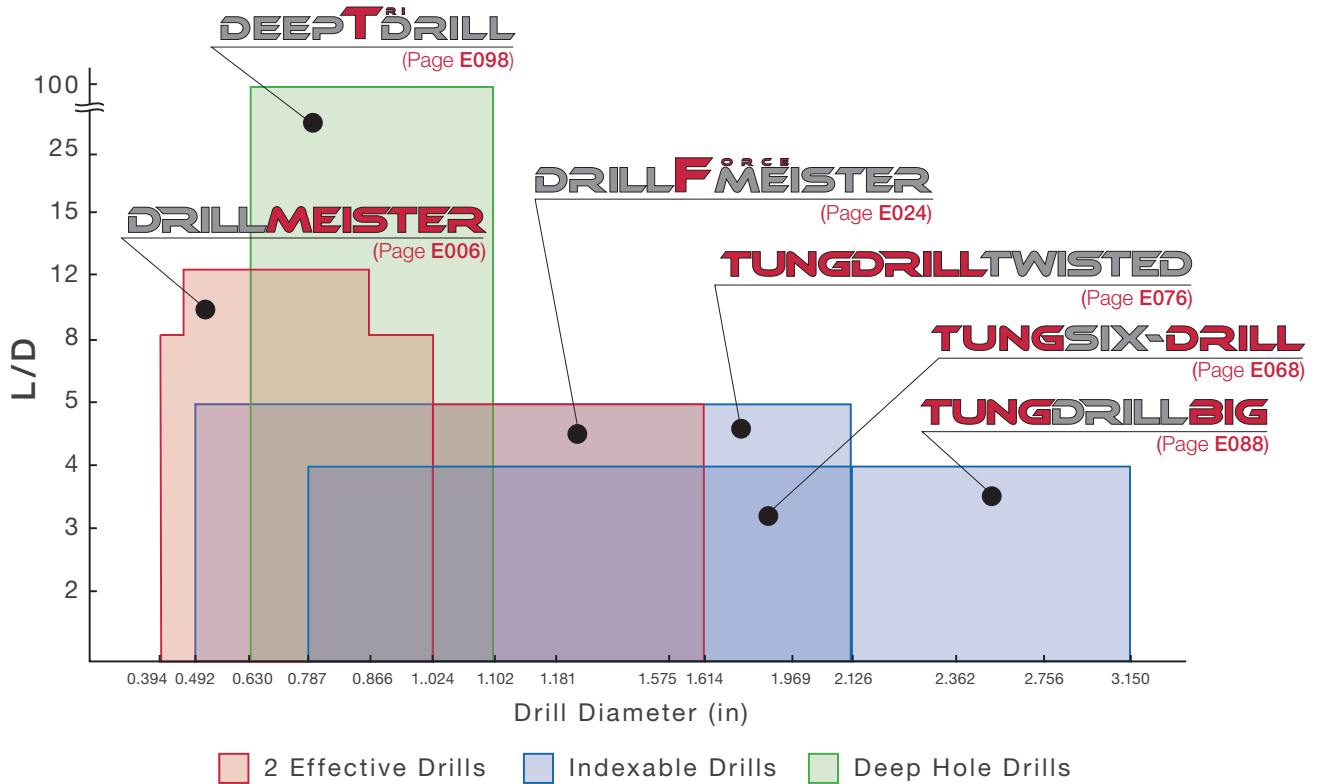

Hole diameter tolerance*

TUNGSIX-DRILL

L/D	Tool diameter	Hole diameter tolerance*
2	ø0.787 - ø1.063	+ 0.010 / 0
	ø1.102 - ø2.126	+ 0.012 / 0
3	ø0.787 - ø1.063	+ 0.010 / 0
	ø1.102 - ø2.126	+ 0.012 / 0
4	ø0.787 - ø1.063	+ 0.012 / 0
	ø1.102 - ø2.126	+ 0.014 / 0

TUNGDRILLTWISTED

L/D	Tool diameter	Hole diameter tolerance*
2	ø0.492 - ø0.669	+ 0.010 / 0
	ø0.689 - ø2.163	+ 0.012 / 0
3	ø0.492 - ø0.669	+ 0.010 / 0
	ø0.689 - ø2.163	+ 0.012 / 0
4	ø0.492 - ø0.669	+ 0.016 / 0
	ø0.689 - ø2.163	+ 0.018 / 0
5	ø0.492 - ø0.669	+ 0.016 / 0
	ø0.689 - ø2.163	+ 0.018 / 0

DRILLMEISTER

L/D	Tool diameter	Hole diameter tolerance*
TID 1.5	ø0.394 - ø1.020	+ 0.0019 / 0
TID 3	ø0.394 - ø1.020	+ 0.0019 / 0
TID 5	ø0.394 - ø0.705	+ 0.0023 / 0
	ø0.709 - ø1.020	+ 0.0025 / 0
TID 8	ø0.394 - ø0.705	+ 0.0027 / 0
	ø0.709 - ø1.020	+ 0.0033 / 0
TID 12	ø0.472 - ø0.705	+ 0.0031 / 0
	ø0.709 - ø1.020	+ 0.0037 / 0
TIDC 3	ø0.394 - ø0.783	+ 0.0019 / 0
TIDC 5	ø0.394 - ø0.783	+ 0.0019 / 0

DRILLFMEISTER

L/D	Tool diameter	Hole diameter tolerance*
3	ø1.024 - ø1.177	+ 0.0019 / 0
	ø1.181 - ø1.614	+ 0.0023 / 0
5	ø1.024 - ø1.177	+ 0.0031 / 0
	ø1.181 - ø1.614	+ 0.0035 / 0

DEEPTDRILL

L/D	Tool diameter	Hole diameter tolerance*
10	ø0.630 - ø1.102	+ 0.0019 / - 0.004
15	ø0.630 - ø1.102	+ 0.0019 / - 0.004
25	ø0.630 - ø1.102	+ 0.0019 / - 0.004

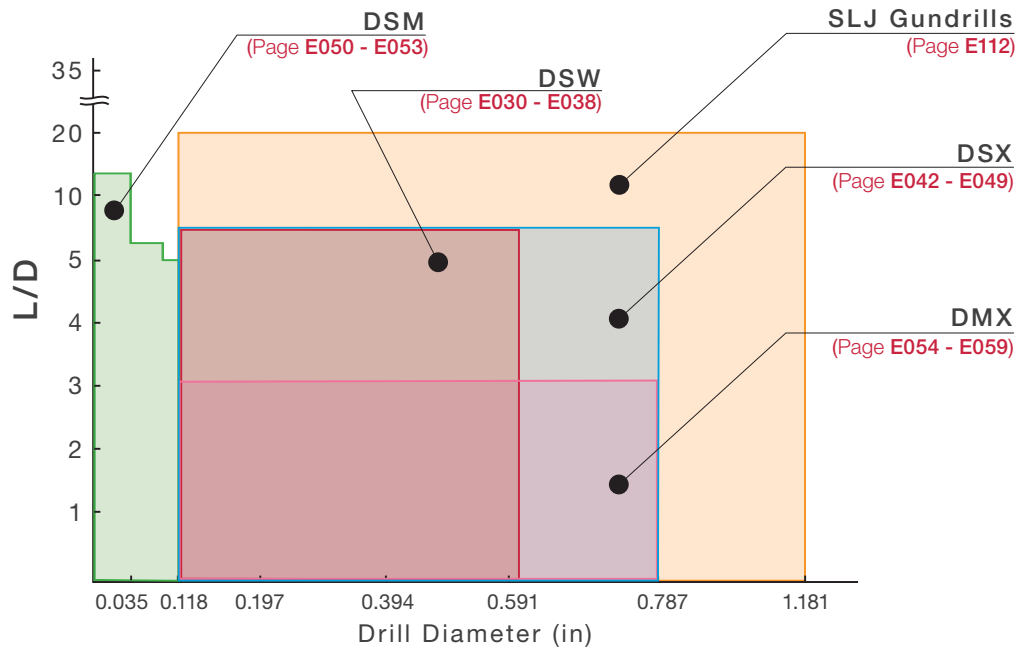

* Just for reference

Solid Drills, Brazed Carbide Drills

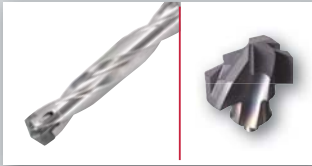

DrillLine - 2 Effective Drill

Head-Changeable Drill

		Inch	Metric
	DRILLMEISTER Drills with head-changeable system ⌀0.394" - ⌀1.020" (⌀10 mm - ⌀25.9 mm) / L/D = 1.5, 3, 5, 8 ※ L/D = 12 : ⌀0.472" - ⌀0.902" (⌀12 - ⌀22.9)	<u>E006</u>	<input checked="" type="checkbox"/> <input checked="" type="checkbox"/>
	DRILLFORCE MEISTER Drills featuring indexable inserts with 2-effective cutting edges for large diameter drilling ⌀1.024" - ⌀1.614" (⌀26 mm - ⌀41 mm) / L/D = 3, 5	<u>E024</u>	<input checked="" type="checkbox"/> <input type="checkbox"/>

Solid Drill

	Solid Carbide Drills Solid carbide drills for excellent performance ⌀3.0 - ⌀20.0 mm (⌀0.118" - ⌀0.787")	<u>E029</u>	<input checked="" type="checkbox"/> <input checked="" type="checkbox"/>
---	--	-------------	---



DrillForce-Meister

Tungaloy E005



2-effective Drill

DRILLMEISTER

TID L/D=1.5

Indexable head drill

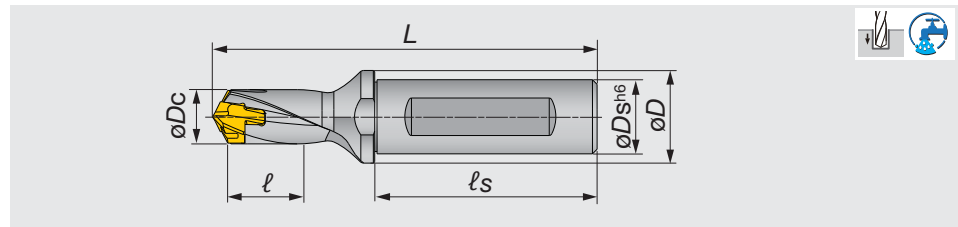

Inch	$\varnothing D_c$	$\varnothing D_s$	$\varnothing D$	ℓ	ℓ_s	L	Pocket size	Head
TIDU0394F0625-1.5	0.394 - 0.429	0.625	0.787	0.591	1.890	3.118	10	DMP100 - DMP109
TIDU0433F0625-1.5	0.433 - 0.468	0.625	0.787	0.669	1.890	3.193	11	DMP110 - DMP119
TIDU0472F0625-1.5	0.472 - 0.508	0.625	0.787	0.709	1.890	3.268	12	DMP120 - DMP129
TIDU0512F0625-1.5	0.512 - 0.547	0.625	0.787	0.787	1.890	3.350	13	DMP130 - DMP139
TIDU0551F0625-1.5	0.551 - 0.587	0.625	0.787	0.827	1.890	3.508	14	DMP140 - DMP149
TIDU0591F0750-1.5	0.591 - 0.625	0.750	0.984	0.906	1.969	3.787	15	DMP150 - DMP159
TIDU0630F0750-1.5	0.630 - 0.665	0.750	0.984	0.945	1.969	3.909	16	DMP160 - DMP169
TIDU0669F0750-1.5	0.669 - 0.705	0.750	0.984	1.024	1.969	4.031	17	DMP170 - DMP179
TIDU0709F1000-1.5	0.709 - 0.744	1.000	1.260	1.063	2.205	4.390	18	DMP180 - DMP189
TIDU0748F1000-1.5	0.748 - 0.783	1.000	1.260	1.142	2.205	4.508	19	DMP190 - DMP199
TIDU0787F1000-1.5	0.787 - 0.823	1.000	1.260	1.181	2.205	4.630	20	DMP200 - DMP209
TIDU0827F1000-1.5	0.827 - 0.862	1.000	1.260	1.240	2.205	4.752	21	DMP210 - DMP219
TIDU0866F1000-1.5	0.866 - 0.902	1.000	1.260	1.299	2.205	4.874	22	DMP220 - DMP229
TIDU0906F1250-1.5	0.906 - 0.941	1.250	1.654	1.358	2.362	5.150	23	DMP230 - DMP239
TIDU0945F1250-1.5	0.945 - 0.980	1.250	1.654	1.417	2.362	5.272	24	DMP240 - DMP249
TIDU0984F1250-1.5	0.984 - 1.020	1.250	1.654	1.476	2.362	5.394	25	DMP250 - DMP259

Tool diameter	Hole diameter tolerance*
$\varnothing 0.394 - \varnothing 1.020$	+0.0020 / 0

*Just for reference



SPARE PARTS

Designation	Clamping key
TIDU0394 - TIDU0748	K-TID10-19.99
TIDU0787 - TIDU0984	K-TID20-26.99

Reference pages

Head → E018 - E020, Standard cutting conditions → E020

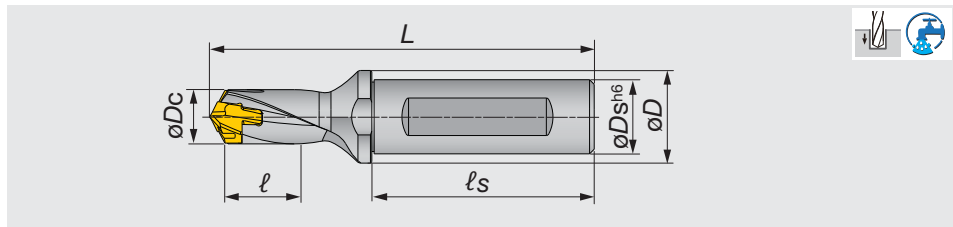

Metric	$\varnothing D_c$	$\varnothing D_s$	$\varnothing D$	l	l_s	L	Pocket size	Head
TID060F12-1.5	6 - 6.4	12	16	9	45	68	6	DMP060 - DMP064
TID065F12-1.5	6.5 - 6.9	12	16	10	45	69.1	6	DMP065 - DMP069
TID070F12-1.5	7 - 7.4	12	16	11	45	70.1	7	DMP070 - DMP074
TID075F12-1.5	7.5 - 7.9	12	16	11.3	45	70.9	7	DMP075 - DMP079
TID080F12-1.5	8 - 8.9	12	16	12	45	72.4	8	DMP080 - DMP089
TID090F12-1.5	9 - 9.9	12	16	14	45	74.3	9	DMP090 - DMP099
TID100F16-1.5	10 - 10.9	16	20	15	48	79.2	10	DMP100 - DMP109
TID110F16-1.5	11 - 11.9	16	20	17	48	81.1	11	DMP110 - DMP119
TID120F16-1.5	12 - 12.9	16	20	18	48	83	12	DMP120 - DMP129
TID130F16-1.5	13 - 13.9	16	20	20	48	85.1	13	DMP130 - DMP139
TID140F16-1.5	14 - 14.9	16	20	21	48	89.1	14	DMP140 - DMP149
TID150F20-1.5	15 - 15.9	20	25	23	50	96.2	15	DMP150 - DMP159
TID160F20-1.5	16 - 16.9	20	25	24	50	99.3	16	DMP160 - DMP169
TID170F20-1.5	17 - 17.9	20	25	26	50	102.4	17	DMP170 - DMP179
TID180F25-1.5	18 - 18.9	25	32	27	56	111.5	18	DMP180 - DMP189
TID190F25-1.5	19 - 19.9	25	32	29	56	114.5	19	DMP190 - DMP199
TID200F25-1.5	20 - 20.9	25	32	30	56	117.6	20	DMP200 - DMP209
TID210F25-1.5	21 - 21.9	25	32	32	56	120.7	21	DMP210 - DMP219
TID220F25-1.5	22 - 22.9	25	32	33	56	123.8	22	DMP220 - DMP229
TID230F32-1.5	23 - 23.9	32	42	35	60	130.8	23	DMP230 - DMP239
TID240F32-1.5	24 - 24.9	32	42	36	60	133.9	24	DMP240 - DMP249
TID250F32-1.5	25 - 25.9	32	42	38	60	137	25	DMP250 - DMP259

Tool diameter	Hole diameter tolerance*
$\varnothing 6 - \varnothing 25.9$	+0.05 / 0

*Just for reference

SPARE PARTS



Designation	Clamping key
TID060-090	K-TID6-9.99
TID100-190	K-TID10-19.99
TID200-250	K-TID20-26.99

Reference pages

Head → E018 - E020, Standard cutting conditions → E020



2-effective Drill

DRILLMEISTER

TID L/D=3

Indexable head drill

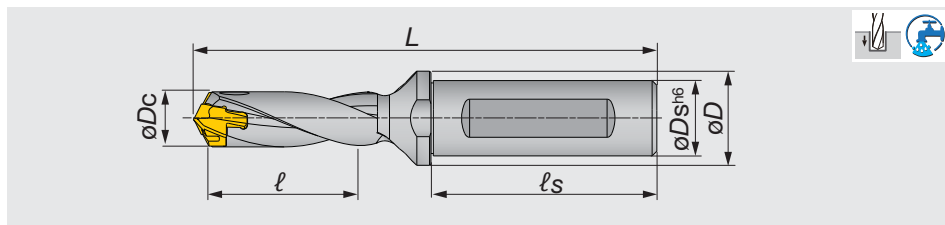

Inch	$\varnothing D_c$	$\varnothing D_s$	$\varnothing D$	ℓ	ℓ_s	L	Pocket size	Head
TIDU0394F0625-3	0.394 - 0.409	0.625	0.787	1.181	1.890	3.709	10	DMP100 - DMP104
TIDU0413F0625-3	0.413 - 0.429	0.625	0.787	1.260	1.890	3.768	10	DMP105 - DMP109
TIDU0433F0625-3	0.433 - 0.449	0.625	0.787	1.299	1.890	3.843	11	DMP110 - DMP114
TIDU0453F0625-3	0.453 - 0.469	0.625	0.787	1.378	1.890	3.902	11	DMP115 - DMP119
TIDU0472F0625-3	0.472 - 0.488	0.625	0.787	1.417	1.890	3.976	12	DMP120 - DMP124
TIDU0492F0625-3	0.492 - 0.508	0.625	0.787	1.457	1.890	4.035	12	DMP125 - DMP129
TIDU0512F0625-3	0.512 - 0.528	0.625	0.787	1.535	1.890	4.118	13	DMP130 - DMP134
TIDU0532F0625-3	0.532 - 0.547	0.625	0.787	1.614	1.890	4.177	13	DMP135 - DMP139
TIDU0551F0625-3	0.551 - 0.567	0.625	0.787	1.654	1.890	4.335	14	DMP140 - DMP144
TIDU0571F0625-3	0.571 - 0.587	0.625	0.787	1.732	1.890	4.394	14	DMP145 - DMP149
TIDU0591F0750-3	0.591 - 0.626	0.750	0.984	1.772	1.969	4.673	15	DMP150 - DMP159
TIDU0630F0750-3	0.630 - 0.665	0.750	0.984	1.890	1.969	4.854	16	DMP160 - DMP169
TIDU0669F0750-3	0.669 - 0.705	0.750	0.984	2.008	1.969	5.035	17	DMP170 - DMP179
TIDU0709F1000-3	0.709 - 0.744	1.000	1.260	2.126	2.205	5.453	18	DMP180 - DMP189
TIDU0748F1000-3	0.748 - 0.783	1.000	1.260	2.244	2.205	5.630	19	DMP190 - DMP199
TIDU0787F1000-3	0.787 - 0.823	1.000	1.260	2.362	2.205	5.811	20	DMP200 - DMP209
TIDU0827F1000-3	0.827 - 0.862	1.000	1.260	2.480	2.205	5.992	21	DMP210 - DMP219
TIDU0866F1000-3	0.866 - 0.902	1.000	1.260	2.598	2.205	6.173	22	DMP220 - DMP229
TIDU0906F1250-3	0.906 - 0.941	1.250	1.654	2.718	2.362	6.508	23	DMP230 - DMP239
TIDU0945F1250-3	0.945 - 0.980	1.250	1.654	2.835	2.362	6.689	24	DMP240 - DMP249
TIDU0984F1250-3	0.984 - 1.020	1.250	1.654	2.953	2.362	6.870	25	DMP250 - DMP259

Tool diameter	Hole diameter tolerance*
$\varnothing 0.394 - \varnothing 1.020$	+0.0020 / 0

*Just for reference

**SPARE PARTS**

Designation	Clamping key
TIDU0394 - TIDU0748	K-TID10-19.99
TIDU0787 - TIDU0984	K-TID20-26.99

Reference pages

Head → E018 - E020, Standard cutting conditions → E020

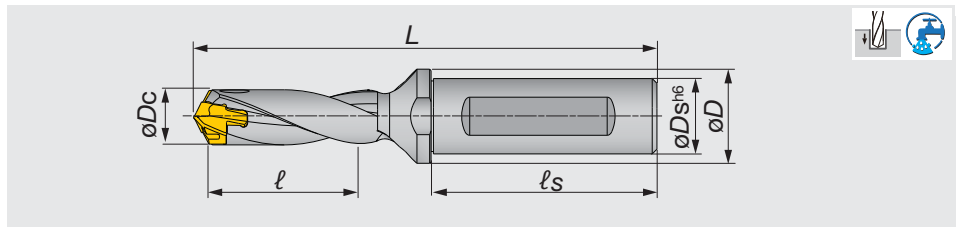

Metric	$\varnothing D_c$	$\varnothing D_s$	$\varnothing D$	ℓ	ℓ_s	L	Pocket size	Head
TID060F12-3	6 - 6.4	12	16	18	45	77	6	DMP060 - DMP064
TID065F12-3	6.5 - 6.9	12	16	20	45	78.8	6	DMP065 - DMP069
TID070F12-3	7 - 7.4	12	16	21	45	80.6	7	DMP070 - DMP074
TID075F12-3	7.5 - 7.9	12	16	23	45	82.1	7	DMP075 - DMP079
TID080F12-3	8 - 8.4	12	16	24	45	84.4	8	DMP080 - DMP084
TID085F12-3	8.5 - 8.9	12	16	26	45	85.9	8	DMP085 - DMP089
TID090F12-3	9 - 9.4	12	16	27	45	87.8	9	DMP090 - DMP094
TID095F12-3	9.5 - 9.9	12	16	29	45	89.3	9	DMP095 - DMP099
TID100F16-3	10 - 10.4	16	20	30	48	94.2	10	DMP100 - DMP104
TID105F16-3	10.5 - 10.9	16	20	32	48	95.7	10	DMP105 - DMP109
TID110F16-3	11 - 11.4	16	20	33	48	97.6	11	DMP110 - DMP114
TID115F16-3	11.5 - 11.9	16	20	35	48	99.1	11	DMP115 - DMP119
TID120F16-3	12 - 12.4	16	20	36	48	101	12	DMP120 - DMP124
TID125F16-3	12.5 - 12.9	16	20	37	48	102.5	12	DMP125 - DMP129
TID130F16-3	13 - 13.4	16	20	39	48	104.6	13	DMP130 - DMP134
TID135F16-3	13.5 - 13.9	16	20	41	48	106.1	13	DMP135 - DMP139
TID140F16-3	14 - 14.4	16	20	42	48	110.1	14	DMP140 - DMP144
TID145F16-3	14.5 - 14.9	16	20	44	48	111.6	14	DMP145 - DMP149
TID150F20-3	15 - 15.9	20	25	45	50	118.7	15	DMP150 - DMP159
TID160F20-3	16 - 16.9	20	25	48	50	123.3	16	DMP160 - DMP169
TID170F20-3	17 - 17.9	20	25	51	50	127.9	17	DMP170 - DMP179
TID180F25-3	18 - 18.9	25	32	54	56	138.5	18	DMP180 - DMP189
TID190F25-3	19 - 19.9	25	32	57	56	143	19	DMP190 - DMP199
TID200F25-3	20 - 20.9	25	32	60	56	147.6	20	DMP200 - DMP209
TID210F25-3	21 - 21.9	25	32	63	56	152.2	21	DMP210 - DMP219
TID220F25-3	22 - 22.9	25	32	66	56	156.8	22	DMP220 - DMP229
TID230F32-3	23 - 23.9	32	42	69	60	165.3	23	DMP230 - DMP239
TID240F32-3	24 - 24.9	32	42	72	60	169.9	24	DMP240 - DMP249
TID250F32-3	25 - 25.9	32	42	75	60	174.5	25	DMP250 - DMP259

Tool diameter	Hole diameter tolerance*
$\varnothing 6 - \varnothing 25.9$	+0.05 / 0

*Just for reference

SPARE PARTS



Designation	Clamping key
TID060-095	K-TID6-9.99
TID100-190	K-TID10-19.99
TID200-250	K-TID20-26.99

Reference pages

Head → E018 - E020, Standard cutting conditions → E020



2-effective Drill

DRILLMEISTER**TID L/D=5**

Indexable head drill

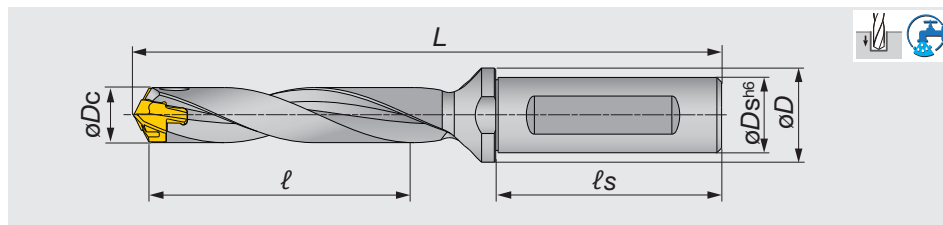

Inch	øDc	øDs	øD	l	ls	L	Pocket size	Head
TIDU0394F0625-5	0.394 - 0.409	0.625	0.787	1.969	1.890	4.575	10	DMP100 - DMP104
TIDU0413F0625-5	0.413 - 0.429	0.625	0.787	2.087	1.890	4.791	10	DMP105 - DMP109
TIDU0433F0625-5	0.433 - 0.449	0.625	0.787	2.165	1.890	4.984	11	DMP110 - DMP114
TIDU0453F0625-5	0.453 - 0.469	0.625	0.787	2.283	1.890	5.201	11	DMP115 - DMP119
TIDU0472F0625-5	0.472 - 0.488	0.625	0.787	2.362	1.890	5.394	12	DMP120 - DMP124
TIDU0492F0625-5	0.492 - 0.508	0.625	0.787	2.441	1.890	5.571	12	DMP125 - DMP129
TIDU0512F0625-5	0.512 - 0.528	0.625	0.787	2.559	1.890	5.811	13	DMP130 - DMP134
TIDU0532F0625-5	0.532 - 0.547	0.625	0.787	2.677	1.890	6.028	13	DMP135 - DMP139
TIDU0551F0625-5	0.551 - 0.567	0.625	0.787	2.756	1.890	6.307	14	DMP140 - DMP144
TIDU0571F0625-5	0.571 - 0.587	0.625	0.787	2.874	1.890	6.524	14	DMP145 - DMP149
TIDU0591F0750-5	0.591 - 0.626	0.750	0.984	2.953	1.969	6.839	15	DMP150 - DMP159
TIDU0630F0750-5	0.630 - 0.665	0.750	0.984	3.150	1.969	7.295	16	DMP160 - DMP169
TIDU0669F0750-5	0.669 - 0.705	0.750	0.984	3.346	1.969	7.752	17	DMP170 - DMP179
TIDU0709F1000-5	0.709 - 0.744	1.000	1.260	3.543	2.205	8.209	18	DMP180 - DMP189
TIDU0748F1000-5	0.748 - 0.783	1.000	1.260	3.740	2.205	8.661	19	DMP190 - DMP199
TIDU0787F1000-5	0.787 - 0.823	1.000	1.260	3.937	2.205	2.723	20	DMP200 - DMP209
TIDU0827F1000-5	0.827 - 0.862	1.000	1.260	4.134	2.205	7.646	21	DMP210 - DMP219
TIDU0866F1000-5	0.866 - 0.902	1.000	1.260	4.331	2.205	7.906	22	DMP220 - DMP229
TIDU0906F1250-5	0.906 - 0.941	1.250	1.654	4.528	2.362	8.319	23	DMP230 - DMP239
TIDU0945F1250-5	0.945 - 0.980	1.250	1.654	4.724	2.362	8.579	24	DMP240 - DMP249
TIDU0984F1250-5	0.984 - 1.020	1.250	1.654	4.921	2.362	8.839	25	DMP250 - DMP259

Tool diameter	Hole diameter tolerance*
ø0.394 - ø0.783	+0.0024 / 0
ø0.787 - ø1.020	+0.0026 / 0

*Just for reference

**SPARE PARTS**

Designation	Clamping key
TIDU0394 - TIDU0748	K-TID10-19.99
TIDU0787 - TIDU0984	K-TID20-26.99

Reference pages

Head → **E018 - E020**, Standard cutting conditions → **E020**E010 www.tungaloyamerica.com

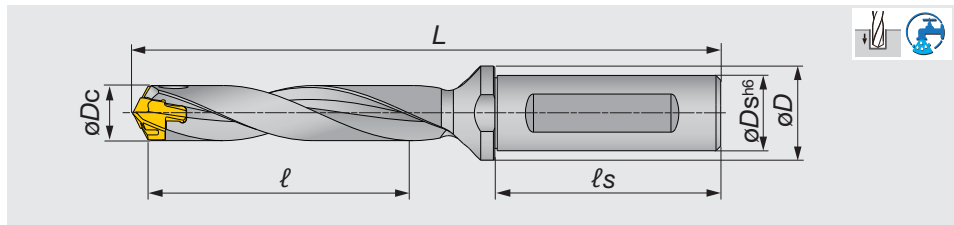

Metric	øDc	øDs	øD	l	ls	L	Pocket size	Head
TID060F12-5	6 - 6.4	12	16	30	45	89	6	DMP060-DMP064
TID065F12-5	6.5 - 6.9	12	16	33	45	91.8	6	DMP065-DMP069
TID070F12-5	7 - 7.4	12	16	35	45	94.6	7	DMP070-DMP074
TID075F12-5	7.5 - 7.9	12	16	38	45	97.1	7	DMP075-DMP079
TID080F12-5	8 - 8.4	12	16	40	45	100.4	8	DMP080-DMP084
TID085F12-5	8.5 - 8.9	12	16	43	45	102.9	8	DMP085-DMP089
TID090F12-5	9 - 9.4	12	16	45	45	105.8	9	DMP090-DMP094
TID095F12-5	9.5 - 9.9	12	16	48	45	108.3	9	DMP095-DMP099
TID100F16-5	10 - 10.4	16	20	50	48	114.2	10	DMP100 - DMP104
TID105F16-5	10.5 - 10.9	16	20	53	48	116.7	10	DMP105 - DMP109
TID110F16-5	11 - 11.4	16	20	55	48	119.6	11	DMP110 - DMP114
TID115F16-5	11.5 - 11.9	16	20	58	48	122.1	11	DMP115 - DMP119
TID120F16-5	12 - 12.4	16	20	60	48	125	12	DMP120 - DMP124
TID125F16-5	12.5 - 12.9	16	20	62	48	127.5	12	DMP125 - DMP129
TID130F16-5	13 - 13.4	16	20	65	48	130.6	13	DMP130 - DMP134
TID135F16-5	13.5 - 13.9	16	20	68	48	133.1	13	DMP135 - DMP139
TID140F16-5	14 - 14.4	16	20	70	48	138.2	14	DMP140 - DMP144
TID145F16-5	14.5 - 14.9	16	20	73	48	140.7	14	DMP145 - DMP149
TID150F20-5	15 - 15.9	20	25	75	50	148.7	15	DMP150 - DMP159
TID160F20-5	16 - 16.9	20	25	80	50	155.3	16	DMP160 - DMP169
TID170F20-5	17 - 17.9	20	25	85	50	161.9	17	DMP170 - DMP179
TID180F25-5	18 - 18.9	25	32	90	56	174.5	18	DMP180 - DMP189
TID190F25-5	19 - 19.9	25	32	95	56	181	19	DMP190 - DMP199
TID200F25-5	20 - 20.9	25	32	100	56	187.6	20	DMP200 - DMP209
TID210F25-5	21 - 21.9	25	32	105	56	194.2	21	DMP210 - DMP219
TID220F25-5	22 - 22.9	25	32	110	56	200.8	22	DMP220 - DMP229
TID230F32-5	23 - 23.9	32	42	115	60	211.3	23	DMP230 - DMP239
TID240F32-5	24 - 24.9	32	42	120	60	217.9	24	DMP240 - DMP249
TID250F32-5	25 - 25.9	32	42	125	60	224.5	25	DMP250 - DMP259

Tool diameter	Hole diameter tolerance*
ø6 - ø17.9	+0.06 / 0
ø18 - ø25.9	+0.065 / 0

*Just for reference



SPARE PARTS

Designation	Clamping key
TID060-095	K-TID6-9.99
TID100-190	K-TID10-19.99
TID200-250	K-TID20-26.99

Reference pages

Head → E018 - E020, Standard cutting conditions → E020



2-effective Drill

DRILLMEISTER

TID L/D=8

Indexable head drill

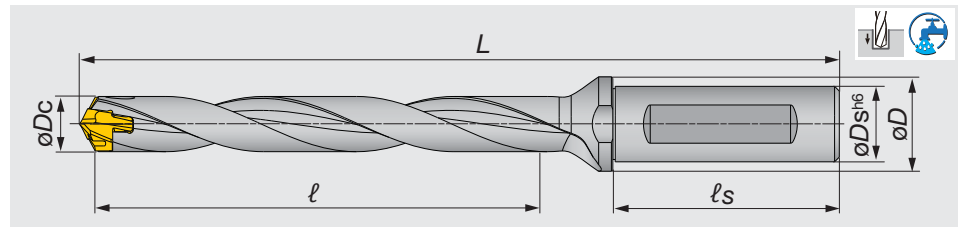

Inch	ϕD_c	ϕD_s	ϕD	l	l_s	L	Pocket size	Head
TIDU0394F0625-8	0.394 - 0.409	0.625	0.787	3.150	1.890	5.677	10	DMP100 - DMP104
TIDU0413F0625-8	0.413 - 0.429	0.625	0.787	3.307	1.890	5.835	10	DMP105 - DMP109
TIDU0433F0625-8	0.433 - 0.449	0.625	0.787	3.465	1.890	6.008	11	DMP110 - DMP114
TIDU0453F0625-8	0.453 - 0.469	0.625	0.787	3.622	1.890	6.165	11	DMP115 - DMP119
TIDU0472F0625-8	0.472 - 0.488	0.625	0.787	3.780	1.890	6.339	12	DMP120 - DMP124
TIDU0492F0625-8	0.492 - 0.508	0.625	0.787	3.937	1.890	6.496	12	DMP125 - DMP129
TIDU0512F0625-8	0.512 - 0.528	0.625	0.787	4.094	1.890	6.677	13	DMP130 - DMP134
TIDU0532F0625-8	0.532 - 0.547	0.625	0.787	4.252	1.890	6.835	13	DMP135 - DMP139
TIDU0551F0625-8	0.551 - 0.567	0.625	0.787	4.409	1.890	7.091	14	DMP140 - DMP144
TIDU0571F0625-8	0.571 - 0.587	0.625	0.787	4.567	1.890	7.252	14	DMP145 - DMP149
TIDU0591F0750-8	0.591 - 0.626	0.750	0.984	4.724	1.969	7.626	15	DMP150 - DMP159
TIDU0630F0750-8	0.630 - 0.665	0.750	0.984	5.039	1.969	8.004	16	DMP160 - DMP169
TIDU0669F0750-8	0.669 - 0.705	0.750	0.984	5.354	1.969	8.382	17	DMP170 - DMP179
TIDU0709F1000-8	0.709 - 0.744	1.000	1.260	5.669	2.205	8.996	18	DMP180 - DMP189
TIDU0748F1000-8	0.748 - 0.783	1.000	1.260	5.984	2.205	9.370	19	DMP190 - DMP199
TIDU0787F1000-8	0.787 - 0.823	1.000	1.260	6.299	2.205	9.748	20	DMP200 - DMP209
TIDU0827F1000-8	0.827 - 0.862	1.000	1.260	6.614	2.205	10.126	21	DMP210 - DMP219
TIDU0866F1000-8	0.866 - 0.902	1.000	1.260	6.929	2.205	10.504	22	DMP220 - DMP229
TIDU0906F1250-8	0.906 - 0.941	1.250	1.654	7.244	2.362	11.035	23	DMP230 - DMP239
TIDU0945F1250-8	0.945 - 0.980	1.250	1.654	7.559	2.362	11.413	24	DMP240 - DMP249
TIDU0984F1250-8	0.984 - 1.020	1.250	1.654	7.874	2.362	11.791	25	DMP250 - DMP259

Tool diameter	Hole diameter tolerance*
$\phi 0.394 - \phi 0.783$	+0.0030 / 0
$\phi 0.787 - \phi 1.020$	+0.0033 / 0

*Just for reference

SPARE PARTS



Designation	Clamping key
TIDU0394 - TIDU0748	K-TID10-19.99
TIDU0787 - TIDU0984	K-TID20-26.99

Reference pages

Head → E018 - E020, Standard cutting conditions → E020

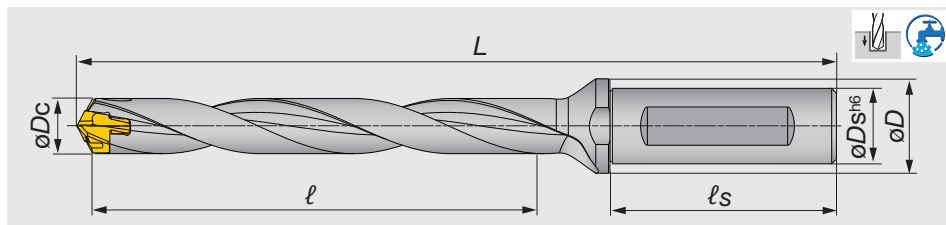

Metric	$\varnothing D_c$	$\varnothing D_s$	$\varnothing D$	l	l_s	L	Pocket size	Head
TID070F12-8	7 - 7.4	12	16	56	45	115.6	7	DMP070 - DMP074
TID075F12-8	7.5 - 7.9	12	16	60	45	119.6	7	DMP075 - DMP079
TID080F12-8	8 - 8.4	12	16	64	45	124.4	8	DMP080 - DMP084
TID085F12-8	8.5 - 8.9	12	16	68	45	128.4	8	DMP085 - DMP089
TID090F12-8	9 - 9.4	12	16	72	45	132.8	9	DMP090 - DMP094
TID095F12-8	9.5 - 9.9	12	16	76	45	136.8	9	DMP095 - DMP099
TID100F16-8	10 - 10.4	16	20	80	48	144.2	10	DMP100 - DMP104
TID105F16-8	10.5 - 10.9	16	20	84	48	148.2	10	DMP105 - DMP109
TID110F16-8	11 - 11.4	16	20	88	48	152.6	11	DMP110 - DMP114
TID115F16-8	11.5 - 11.9	16	20	92	48	156.6	11	DMP115 - DMP119
TID120F16-8	12 - 12.4	16	20	96	48	161	12	DMP120 - DMP124
TID125F16-8	12.5 - 12.9	16	20	100	48	165	12	DMP125 - DMP129
TID130F16-8	13 - 13.4	16	20	104	48	169.6	13	DMP130 - DMP134
TID135F16-8	13.5 - 13.9	16	20	108	48	173.6	13	DMP135 - DMP139
TID140F16-8	14 - 14.4	16	20	112	48	180.1	14	DMP140 - DMP144
TID145F16-8	14.5 - 14.9	16	20	116	48	184.2	14	DMP145 - DMP149
TID150F20-8	15 - 15.9	20	25	120	50	193.7	15	DMP150 - DMP159
TID160F20-8	16 - 16.9	20	25	128	50	203.3	16	DMP160 - DMP169
TID170F20-8	17 - 17.9	20	25	136	50	212.9	17	DMP170 - DMP179
TID180F25-8	18 - 18.9	25	32	144	56	228.5	18	DMP180 - DMP189
TID190F25-8	19 - 19.9	25	32	152	56	238	19	DMP190 - DMP199
TID200F25-8	20 - 20.9	25	32	160	56	247.6	20	DMP200 - DMP209
TID210F25-8	21 - 21.9	25	32	168	56	257.2	21	DMP210 - DMP219
TID220F25-8	22 - 22.9	25	32	176	56	266.8	22	DMP220 - DMP229
TID230F32-8	23 - 23.9	32	42	184	60	280.3	23	DMP230 - DMP239
TID240F32-8	24 - 24.9	32	42	192	60	289.9	24	DMP240 - DMP249
TID250F32-8	25 - 25.9	32	42	200	60	299.5	25	DMP250 - DMP259

Tool diameter	Hole diameter tolerance*
$\varnothing 7 - \varnothing 17.9$	+0.07 / 0
$\varnothing 18 - \varnothing 25.9$	+0.085 / 0

*Just for reference



SPARE PARTS

Designation	Clamping key
TID060-095	K-TID6-9.99
TID100-190	K-TID10-19.99
TID200-250	K-TID20-26.99

Reference pages

Head → E018 - E020, Standard cutting conditions → E020

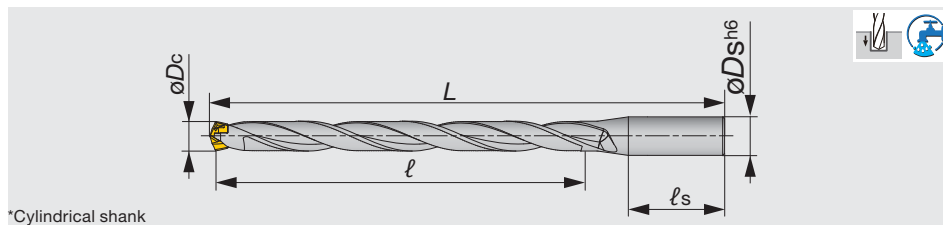

Inch	$\varnothing D_c$	$\varnothing D_s$	ℓ	ℓ_s	L	Pocket size	Head
TIDU0472R0625-12	0.472 - 0.488	0.625	5.669	1.890	8.228	12	DMP120 - 124
TIDU0492R0625-12	0.492 - 0.508	0.625	5.906	1.890	8.465	12	DMP125 - 129
TIDU0512R0625-12	0.512 - 0.528	0.625	6.142	1.890	8.701	13	DMP130 - 134
TIDU0532R0625-12	0.531 - 0.547	0.625	6.378	1.890	8.937	13	DMP135 - 139
TIDU0551R0625-12	0.551 - 0.567	0.625	6.614	1.890	9.291	14	DMP140 - 144
TIDU0571R0625-12	0.571 - 0.587	0.625	6.850	1.890	9.528	14	DMP145 - 149
TIDU0591R0750-12	0.591 - 0.626	0.750	7.087	1.969	10.000	15	DMP150 - 159
TIDU0630R0750-12	0.630 - 0.665	0.750	7.559	1.969	10.512	16	DMP160 - 169
TIDU0669R0750-12	0.669 - 0.705	0.750	8.031	1.969	11.063	17	DMP170 - 179
TIDU0709R1000-12	0.709 - 0.744	1.000	8.504	2.205	11.811	18	DMP180 - 189
TIDU0748R1000-12	0.748 - 0.783	1.000	8.976	2.205	12.362	19	DMP190 - 199
TIDU0787R1000-12	0.787 - 0.823	1.000	9.449	2.205	12.874	20	DMP200 - 209
TIDU0827R1000-12	0.827 - 0.862	1.000	9.921	2.205	13.425	21	DMP210 - 219
TIDU0866R1000-12	0.866 - 0.902	1.000	10.394	2.205	13.976	22	DMP220 - 229

Tool diameter	Hole diameter tolerance*
$\varnothing 0.472 - \varnothing 0.705$	+0.0031 / 0
$\varnothing 0.709 - \varnothing 0.902$	+0.0037 / 0

*Just for reference

Metric	$\varnothing D_c$	$\varnothing D_s$	ℓ	ℓ_s	L	Pocket size	Head
TID120R16-12	12 - 12.4	16	144	48	209	12	DMP120 - 124
TID125R16-12	12.5 - 12.9	16	150	48	215	12	DMP125 - 129
TID130R16-12	13 - 13.4	16	156	48	221.6	13	DMP130 - 134
TID135R16-12	13.5 - 13.9	16	162	48	227.6	13	DMP135 - 139
TID140R16-12	14 - 14.4	16	168	48	236.2	14	DMP140 - 144
TID145R16-12	14.5 - 14.9	16	174	48	242.2	14	DMP145 - 149
TID150R20-12	15 - 15.9	20	180	50	253.7	15	DMP150 - 159
TID160R20-12	16 - 16.9	20	192	50	267.3	16	DMP160 - 169
TID170R20-12	17 - 17.9	20	204	50	280.9	17	DMP170 - 179
TID180R25-12	18 - 18.9	25	216	56	300.5	18	DMP180 - 189
TID190R25-12	19 - 19.9	25	228	56	314	19	DMP190 - 199
TID200R25-12	20 - 20.9	25	240	56	327.6	20	DMP200 - 209
TID210R25-12	21 - 21.9	25	252	56	341.2	21	DMP210 - 219
TID220R25-12	22 - 22.9	25	264	56	354.8	22	DMP220 - 229

Tool diameter	Hole diameter tolerance*
$\varnothing 12 - \varnothing 17.9$	+0.08 / 0
$\varnothing 18 - \varnothing 25.9$	+0.095 / 0

*Just for reference

SPARE PARTS

Designation	Clamping key
TDIU0472-0748, TID120-190	K-TID10-19.99
TDIU0787-0866, TID200-220	K-TID20-26.99

Reference pages

Head → E018 - E020, Standard cutting conditions → E020

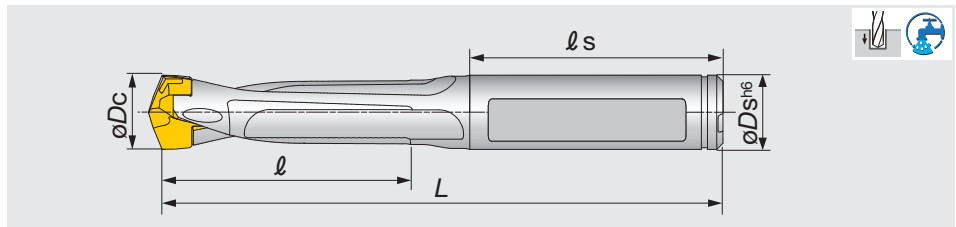

Metric	$\varnothing D_c$	$\varnothing D_s$	ℓ	ℓ_s	L	Pocket size	Head
TIDC100C10-3	10 - 10.4	10	30	41	86.1	10	DMP100 - DMP104
TIDC105C11-3	10.5 - 10.9	11	31.5	41	87.6	10	DMP105 - DMP109
TIDC110C11-3	11 - 11.4	11	33	41	89.5	11	DMP110 - DMP114
TIDC115C12-3	11.5 - 11.9	12	34.5	41	91	11	DMP115 - DMP119
TIDC120C12-3	12 - 12.4	12	36	41	92.8	12	DMP120 - DMP124
TIDC125C13-3	12.5 - 12.9	13	37.5	46	98.3	12	DMP125 - DMP129
TIDC130C13-3	13 - 13.4	13	39	47	102.4	13	DMP130 - DMP134
TIDC135C14-3	13.5 - 13.9	14	40.5	43	99.9	13	DMP135 - DMP139
TIDC140C14-3	14 - 14.4	14	42	44	103	14	DMP140 - DMP144
TIDC145C15-3	14.5 - 14.9	15	43.5	45	105.5	14	DMP145 - DMP149
TIDC150C15-3	15 - 15.9	15	45	45	107.5	15	DMP150 - DMP159
TIDC160C16-3	16 - 16.9	16	48	48	117.5	16	DMP160 - DMP169
TIDC170C17-3	17 - 17.9	17	51	48	119.7	17	DMP170 - DMP179
TIDC180C18-3	18 - 18.9	18	54	48	123.3	18	DMP180 - DMP189
TIDC190C19-3	19 - 19.9	19	57	54	132.4	19	DMP190 - DMP199

Tool diameter	Hole diameter tolerance*
$\varnothing 10 - \varnothing 19.9$	+0.05 / 0

*Just for reference

SPARE PARTS



Designation	Clamping key
TIDC100-190	K-TID10-19.99

Reference pages

Head → E018 - E020, Standard cutting conditions → E020



2-effective Drill

DRILLMEISTER

TIDC L/D=5

Indexable head drill

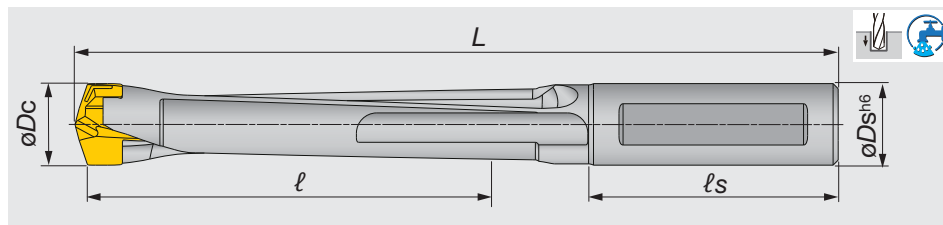

Metric	ϕD_c	ϕD_s	l	l_s	L	Pocket size	Head
TIDC100C10-5	10 - 10.4	10	50	41	106.1	10	DMP100 - DMP104
TIDC105C11-5	10.5 - 10.9	11	52.5	41	108.6	10	DMP105 - DMP109
TIDC110C11-5	11 - 11.4	11	55	41	111.5	11	DMP110 - DMP114
TIDC115C12-5	11.5 - 11.9	12	57.5	41	114	11	DMP115 - DMP119
TIDC120C12-5	12 - 12.4	12	60	41	116.8	12	DMP120 - DMP124
TIDC125C13-5	12.5 - 12.9	13	62.5	46	124.3	12	DMP125 - DMP129
TIDC130C13-5	13 - 13.4	13	65	47	128.4	13	DMP130 - DMP134
TIDC135C14-5	13.5 - 13.9	14	67.5	43	126.9	13	DMP135 - DMP139
TIDC140C14-5	14 - 14.4	14	70	44	131	14	DMP140 - DMP144
TIDC145C15-5	14.5 - 14.9	15	72.5	45	134.5	14	DMP145 - DMP149
TIDC150C15-5	15 - 15.9	15	75	45	137.5	15	DMP150 - DMP159
TIDC160C16-5	16 - 16.9	16	80	48	149.5	16	DMP160 - DMP169
TIDC170C17-5	17 - 17.9	17	85	48	153.7	17	DMP170 - DMP179
TIDC180C18-5	18 - 18.9	18	90	48	159.3	18	DMP180 - DMP189
TIDC190C19-5	19 - 19.9	19	95	54	170.4	19	DMP190 - DMP199

Tool diameter	Hole diameter tolerance*
$\phi 10 - \phi 19.9$	+0.05 / 0

*Just for reference

SPARE PARTS



Designation	Clamping key
TIDC100-190	K-TID10-19.99

CHAMFERING INSERT

XHGT-30A

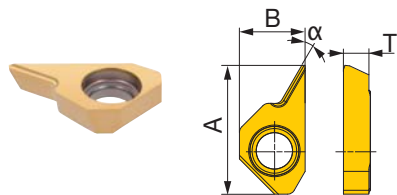

XHGR-45A

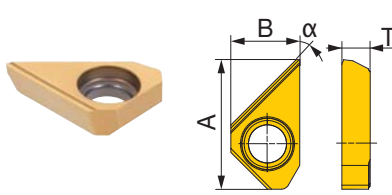

XHGR-60A

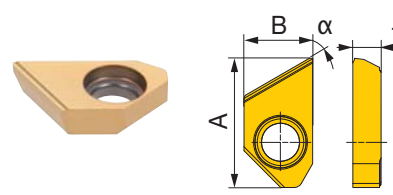

Designation	GH730	A (mm)	B (mm)	T (mm)	Chamfering angle α°	Maximum width of chamfer (mm) **
XHGT090300-30A	●	16	8.5	3.3	30	1.5
XHGR090300-45A	●	16	8.5	3.3	45	6
XHGR090300-60A	●	16	8.5	3.3	60	3.5

**Please reduce the feed rate to half when chamfering over 60% of maximum width of chamfer

● : Line up
Package quantity = 2 pcs.

Reference pages

Head → E018 - E020, Standard cutting conditions → E020

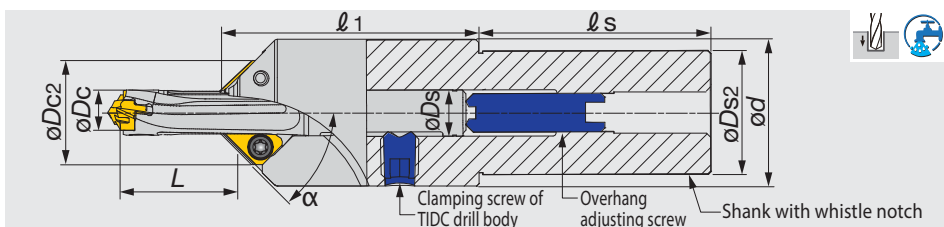

Inch	ϕD_c	ϕD_{s2}	ϕd	ϕD_{c2}	l_1	l_s	$L^* L/D = 3$	$L^* L/D = 5$	Drill body	ϕD_s
TIDCF100-WU1.00-.394-.409	0.374 - 0.409	1.000	0.984	0.980	2.65	2.56	0.571 - 1.252	1.248 - 2.039	TIDC100C10-...	0.394
TIDCF110-WU1.00-.413-.449	0.413 - 0.449	1.000	0.984	1.020	2.65	2.56	0.618 - 1.311	1.228 - 2.134	TIDC105C11-..., TIDC110C11-...	0.433
TIDCF120-WU1.00-.453-.488	0.453 - 0.488	1.000	1.496	1.060	2.65	2.21	0.638 - 1.390	1.343 - 2.256	TIDC115C12-..., TIDC120C12-...	0.472
TIDCF130-WU1.00-.492-.528	0.492 - 0.528	1.000	1.496	1.100	2.65	2.56	0.594 - 1.447	1.331 - 2.339	TIDC125C13-..., TIDC130C13-...	0.512
TIDCF140-WU1.25-.531-.567	0.531 - 0.567	1.250	1.496	1.120	2.65	2.56	0.650 - 1.484	1.441 - 2.425	TIDC135C14-..., TIDC140C14-...	0.551
TIDCF150-WU1.25-.571-.626	0.571 - 0.626	1.250	1.496	1.160	2.65	2.56	0.634 - 1.559	1.563 - 2.551	TIDC145C15-..., TIDC150C15-...	0.591
TIDCF160-WU1.25-.630-.665	0.630 - 0.665	1.250	1.496	1.200	2.65	2.56	0.689 - 1.634	1.681 - 2.677	TIDC160C16-...	0.630
TIDCF170-WU1.25-.669-.705	0.669 - 0.705	1.250	1.496	1.240	2.65	2.56	0.697 - 1.689	1.630 - 2.768	TIDC170C17-...	0.669
TIDCF180-WU1.25-.709-.744	0.709 - 0.744	1.250	1.496	1.280	2.65	2.56	0.713 - 1.772	1.764 - 2.878	TIDC180C18-...	0.709
TIDCF190-WU1.25-.748-.783	0.748 - 0.783	1.250	1.496	1.320	2.95	2.56	0.756 - 1.756	1.732 - 2.909	TIDC190C19-...	0.748

Metric	ϕD_c	ϕD_{s2}	ϕd	ϕD_{c2}	l_1	l_s	$L^* L/D = 3$	$L^* L/D = 5$	Drill body	ϕD_s
TIDCF100-W32	10 - 10.4	32	38	24.9	67.3	60	14.5 - 31.8	31.7 - 51.8	TIDC100C10-...	10
TIDCF110-W32	10.5 - 10.9	32	38	25.9	67.3	60	15.7 - 33.3	31.2 - 54.2	TIDC105C11-...	11
TIDCF110-W32	11 - 11.4	32	38	25.9	67.3	60	16.2 - 35.3	34.1 - 57.3	TIDC110C11-...	11
TIDCF120-W32	11.5 - 11.9	32	38	26.9	67.3	60	15.1 - 36.7	33.8 - 59.4	TIDC115C12-...	12
TIDCF120-W32	12 - 12.4	32	38	26.9	67.3	60	16.5 - 37.7	36.6 - 61.6	TIDC120C12-...	12
TIDCF130-W32	12.5 - 12.9	32	38	27.9	67.3	60	16.1 - 39.6	39.7 - 64.8	TIDC125C13-...	13
TIDCF130-W32	13 - 13.4	32	38	27.9	67.3	60	17.5 - 41.5	42.7 - 68	TIDC130C13-...	13
TIDCF140-W32	13.5 - 13.9	32	38	28.4	67.3	60	17.7 - 42.9	41.4 - 70.3	TIDC135C14-...	14
TIDCF140-W32	14 - 14.4	32	38	28.4	67.3	60	18.1 - 45	44.8 - 73.1	TIDC140C14-...	14
TIDCF150-W32	14.5 - 14.9	32	38	29.4	67.3	60	19.2 - 44.6	44 - 73.9	TIDC145C15-...	15
TIDCF150-W32	15 - 15.9	32	38	29.4	67.3	60	19.7 - 47.4	47.6 - 80.7	TIDC150C15-...	15
TIDCF160-W32	16 - 16.9	32	38	30.4	67.3	60	19.5 - 55.3	57 - 87.5	TIDC160C16-...	16
TIDCF170-W32	17 - 17.9	32	38	31.4	67.3	60	21.4 - 54.9	55.9 - 88.5	TIDC170C17-...	17
TIDCF180-W32	18 - 18.9	32	38	32.4	67.3	60	24.2 - 65.2	60 - 93	TIDC180C18-...	18
TIDCF190-W32	19 - 19.9	32	38	33.4	75	60	28.5 - 62.3	67 - 100	TIDC190C19-...	19

• L^* is the dimension when using 45° chamfering insert.

SPARE PARTS

Designation	Insert screw	Grip	Overhang adjusting screw	Clamping screw of TIDC drill body	Torx bit	Wrench
TIDCF	SR14-544/S	SW6-SD	SRM10X10DIN916	SRM10X1.5S	BT15S	HW5.0

Reference pages

Insert → E016

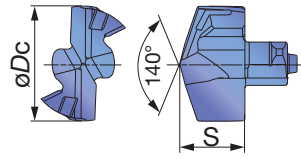
**DRILL HEAD****DMP**

Designation	ϕD_c (in)	ϕD_c (mm)	AH725	S (mm)	Pocket size	Body	Designation	ϕD_c (in)	ϕD_c (mm)	AH725	S (mm)	Pocket size	Body
DMP060	0.236	6	●	4	6	TID*060*	DMP110	0.433	11	●	6.45	11	TID*110...
DMP061	0.240	6.1	●	4	6	TID*060*	DMP111	0.437	11.1	●	6.45	11	TID*110...
DMP062	0.244	6.2	●	4	6	TID*060*	DMP112	0.441	11.2	●	6.45	11	TID*110...
DMP063	0.248	6.3	●	4	6	TID*060*	DMP113	0.445	11.3	●	6.45	11	TID*110...
DMP064	0.252	6.4	●	4	6	TID*060*	DMP114	0.449	11.4	●	6.45	11	TID*110...
DMP065	0.256	6.5	●	4.3	6	TID*065*	DMP115	0.453	11.5	●	6.45	11	TID*115...
DMP066	0.260	6.6	●	4.3	6	TID*065*	DMP116	0.457	11.6	●	6.45	11	TID*115...
DMP067	0.264	6.7	●	4.3	6	TID*065*	DMP117	0.461	11.7	●	6.45	11	TID*115...
DMP068	0.268	6.8	●	4.3	6	TID*065*	DMP118	0.465	11.8	●	6.45	11	TID*115...
DMP069	0.272	6.9	●	4.3	6	TID*065*	DMP119	0.469	11.9	●	6.45	11	TID*115...
DMP070	0.276	7	●	4.6	7	TID*070*	DMP120	0.472	12	●	6.8	12	TID*120...
DMP071	0.280	7.1	●	4.6	7	TID*070*	DMP121	0.476	12.1	●	6.8	12	TID*120...
DMP072	0.284	7.2	●	4.6	7	TID*070*	DMP122	0.480	12.2	●	6.8	12	TID*120...
DMP073	0.288	7.3	●	4.6	7	TID*070*	DMP123	0.484	12.3	●	6.8	12	TID*120...
DMP074	0.292	7.4	●	4.6	7	TID*070*	DMP124	0.488	12.4	●	6.8	12	TID*120...
DMP075	0.296	7.5	●	4.6	7	TID*075*	DMP125	0.492	12.5	●	6.8	12	TID*125...
DMP076	0.300	7.6	●	4.6	7	TID*075*	DMP126	0.496	12.6	●	6.8	12	TID*125...
DMP077	0.304	7.7	●	4.6	7	TID*075*	DMP127	0.500	12.7	●	6.8	12	TID*125...
DMP078	0.308	7.8	●	4.6	7	TID*075*	DMP128	0.504	12.8	●	6.8	12	TID*125...
DMP079	0.312	7.9	●	4.6	7	TID*075*	DMP129	0.508	12.9	●	6.8	12	TID*125...
DMP080	0.316	8	●	5.4	8	TID*080*	DMP130	0.512	13	●	7.4	13	TID*130...
DMP081	0.319	8.1	●	5.4	8	TID*080*	DMP131	0.516	13.1	●	7.4	13	TID*130...
DMP082	0.323	8.2	●	5.4	8	TID*080*	DMP132	0.520	13.2	●	7.4	13	TID*130...
DMP083	0.327	8.3	●	5.4	8	TID*080*	DMP133	0.524	13.3	●	7.4	13	TID*130...
DMP084	0.330	8.4	●	5.4	8	TID*080*	DMP134	0.528	13.4	●	7.4	13	TID*130...
DMP085	0.335	8.5	●	5.4	8	TID*085*	DMP135	0.532	13.5	●	7.4	13	TID*135...
DMP086	0.339	8.6	●	5.4	8	TID*085*	DMP136	0.535	13.6	●	7.4	13	TID*135...
DMP087	0.343	8.7	●	5.4	8	TID*085*	DMP137	0.539	13.7	●	7.4	13	TID*135...
DMP088	0.347	8.8	●	5.4	8	TID*085*	DMP138	0.543	13.8	●	7.4	13	TID*135...
DMP089	0.350	8.9	●	5.4	8	TID*085*	DMP139	0.547	13.9	●	7.4	13	TID*135...
DMP090	0.354	9	●	5.8	9	TID*090*	DMP140	0.551	14	●	7.95	14	TID*140...
DMP091	0.358	9.1	●	5.8	9	TID*090*	DMP141	0.555	14.1	●	7.95	14	TID*140...
DMP092	0.362	9.2	●	5.8	9	TID*090*	DMP142	0.559	14.2	●	7.95	14	TID*140...
DMP093	0.366	9.3	●	5.8	9	TID*090*	DMP143	0.563	14.3	●	7.95	14	TID*140...
DMP094	0.370	9.4	●	5.8	9	TID*090*	DMP144	0.567	14.4	●	7.95	14	TID*140...
DMP095	0.374	9.5	●	5.8	9	TID*095*	DMP145	0.571	14.5	●	7.95	14	TID*145...
DMP096	0.378	9.6	●	5.8	9	TID*095*	DMP146	0.575	14.6	●	7.95	14	TID*145...
DMP097	0.382	9.7	●	5.8	9	TID*095*	DMP147	0.579	14.7	●	7.95	14	TID*145...
DMP098	0.386	9.8	●	5.8	9	TID*095*	DMP148	0.583	14.8	●	7.95	14	TID*145...
DMP099	0.390	9.9	●	5.8	9	TID*095*	DMP149	0.587	14.9	●	7.95	14	TID*145...
DMP100	0.394	10	●	6.05	10	TID*100...	DMP150	0.591	15	●	8.53	15	TID*150...
DMP101	0.398	10.1	●	6.05	10	TID*100...	DMP151	0.594	15.1	●	8.53	15	TID*150...
DMP102	0.402	10.2	●	6.05	10	TID*100...	DMP152	0.598	15.2	●	8.53	15	TID*150...
DMP103	0.406	10.3	●	6.05	10	TID*100...	DMP153	0.602	15.3	●	8.53	15	TID*150...
DMP104	0.409	10.4	●	6.05	10	TID*100...	DMP154	0.606	15.4	●	8.53	15	TID*150...
DMP105	0.413	10.5	●	6.05	10	TID*105...	DMP155	0.610	15.5	●	8.53	15	TID*150...
DMP106	0.417	10.6	●	6.05	10	TID*105...	DMP156	0.614	15.6	●	8.53	15	TID*150...
DMP107	0.421	10.7	●	6.05	10	TID*105...	DMP157	0.618	15.7	●	8.53	15	TID*150...
DMP108	0.425	10.8	●	6.05	10	TID*105...	DMP158	0.622	15.8	●	8.53	15	TID*150...
DMP109	0.429	10.9	●	6.05	10	TID*105...	DMP159	0.626	15.9	●	8.53	15	TID*150...



Designation	øDc (in)	øDc (mm)	AH725	S (mm)	Pocket size	Body	Designation	øDc (in)	øDc (mm)	AH725	S (mm)	Pocket size	Body
DMP160	0.630	16	●	9.1	16	TID*160...	DMP206	0.811	20.6	●	11.4	20	TID*200...
DMP161	0.634	16.1	●	9.1	16	TID*160...	DMP207	0.815	20.7	●	11.4	20	TID*200...
DMP162	0.638	16.2	●	9.1	16	TID*160...	DMP208	0.819	20.8	●	11.4	20	TID*200...
DMP163	0.642	16.3	●	9.1	16	TID*160...	DMP209	0.823	20.9	●	11.4	20	TID*200...
DMP164	0.646	16.4	●	9.1	16	TID*160...	DMP210	0.827	21	●	11.98	21	TID*210...
DMP165	0.650	16.5	●	9.1	16	TID*160...	DMP211	0.831	21.1	●	11.98	21	TID*210...
DMP166	0.654	16.6	●	9.1	16	TID*160...	DMP212	0.835	21.2	●	11.98	21	TID*210...
DMP0656	0.656	16.66	●	9.1	16	TID*160...	DMP213	0.839	21.3	●	11.98	21	TID*210...
DMP167	0.657	16.7	●	9.1	16	TID*160...	DMP214	0.843	21.4	●	11.98	21	TID*210...
DMP168	0.661	16.8	●	9.1	16	TID*160...	DMP215	0.846	21.5	●	11.98	21	TID*210...
DMP169	0.665	16.9	●	9.1	16	TID*160...	DMP216	0.850	21.6	●	11.98	21	TID*210...
DMP170	0.669	17	●	9.7	17	TID*170...	DMP217	0.854	21.7	●	11.98	21	TID*210...
DMP171	0.673	17.1	●	9.7	17	TID*170...	DMP218	0.858	21.8	●	11.98	21	TID*210...
DMP172	0.677	17.2	●	9.7	17	TID*170...	DMP219	0.862	21.9	●	11.98	21	TID*210...
DMP173	0.681	17.3	●	9.7	17	TID*170...	DMP220	0.866	22	●	12.56	22	TID*220...
DMP174	0.685	17.4	●	9.7	17	TID*170...	DMP221	0.870	22.1	●	12.56	22	TID*220...
DMP175	0.689	17.5	●	9.7	17	TID*170...	DMP222	0.874	22.2	●	12.56	22	TID*220...
DMP176	0.693	17.6	●	9.7	17	TID*170...	DMP223	0.878	22.3	●	12.56	22	TID*220...
DMP177	0.697	17.7	●	9.7	17	TID*170...	DMP224	0.882	22.4	●	12.56	22	TID*220...
DMP178	0.701	17.8	●	9.7	17	TID*170...	DMP225	0.886	22.5	●	12.56	22	TID*220...
DMP179	0.705	17.9	●	9.7	17	TID*170...	DMP226	0.890	22.6	●	12.56	22	TID*220...
DMP180	0.709	18	●	10.3	18	TID*180...	DMP227	0.894	22.7	●	12.56	22	TID*220...
DMP181	0.713	18.1	●	10.3	18	TID*180...	DMP228	0.898	22.8	●	12.56	22	TID*220...
DMP182	0.717	18.2	●	10.3	18	TID*180...	DMP229	0.902	22.9	●	12.56	22	TID*220...
DMP183	0.720	18.3	●	10.3	18	TID*180...	DMP230	0.906	23	●	13.13	23	TID*230...
DMP184	0.724	18.4	●	10.3	18	TID*180...	DMP231	0.909	23.1	●	13.13	23	TID*230...
DMP185	0.728	18.5	●	10.3	18	TID*180...	DMP232	0.913	23.2	●	13.13	23	TID*230...
DMP186	0.732	18.6	●	10.3	18	TID*180...	DMP233	0.917	23.3	●	13.13	23	TID*230...
DMP187	0.736	18.7	●	10.3	18	TID*180...	DMP234	0.921	23.4	●	13.13	23	TID*230...
DMP188	0.740	18.8	●	10.3	18	TID*180...	DMP235	0.925	23.5	●	13.13	23	TID*230...
DMP189	0.744	18.9	●	10.3	18	TID*180...	DMP236	0.929	23.6	●	13.13	23	TID*230...
DMP190	0.748	19	●	10.8	19	TID*190...	DMP237	0.933	23.7	●	13.13	23	TID*230...
DMP0750	0.750	19.05	●	10.8	19	TID*190...	DMP238	0.937	23.8	●	13.13	23	TID*230...
DMP191	0.752	19.1	●	10.8	19	TID*190...	DMP239	0.941	23.9	●	13.13	23	TID*230...
DMP192	0.756	19.2	●	10.8	19	TID*190...	DMP240	0.945	24	●	13.7	24	TID*240...
DMP193	0.760	19.3	●	10.8	19	TID*190...	DMP241	0.949	24.1	●	13.7	24	TID*240...
DMP194	0.764	19.4	●	10.8	19	TID*190...	DMP242	0.953	24.2	●	13.7	24	TID*240...
DMP0766	0.766	19.5	●	10.8	19	TID*190...	DMP243	0.957	24.3	●	13.7	24	TID*240...
DMP195	0.768	19.5	●	10.8	19	TID*190...	DMP244	0.961	24.4	●	13.7	24	TID*240...
DMP196	0.772	19.6	●	10.8	19	TID*190...	DMP245	0.965	24.5	●	13.7	24	TID*240...
DMP197	0.776	19.7	●	10.8	19	TID*190...	DMP246	0.969	24.6	●	13.7	24	TID*240...
DMP198	0.780	19.8	●	10.8	19	TID*190...	DMP247	0.972	24.7	●	13.7	24	TID*240...
DMP0781	0.781	19.84	●	10.8	19	TID*190...	DMP248	0.976	24.8	●	13.7	24	TID*240...
DMP199	0.783	19.9	●	10.8	19	TID*190...	DMP249	0.980	24.9	●	13.7	24	TID*240...
DMP200	0.787	20	●	11.4	20	TID*200...	DMP250	0.984	25	●	14.3	25	TID*250...
DMP201	0.791	20.1	●	11.4	20	TID*200...	DMP251	0.988	25.1	●	14.3	25	TID*250...
DMP202	0.795	20.2	●	11.4	20	TID*200...	DMP252	0.992	25.2	●	14.3	25	TID*250...
DMP203	0.799	20.3	●	11.4	20	TID*200...	DMP253	0.996	25.3	●	14.3	25	TID*250...
DMP204	0.803	20.4	●	11.4	20	TID*200...	DMP254	1.000	25.4	●	14.3	25	TID*250...
DMP205	0.807	20.5	●	11.4	20	TID*200...							

● : Line up
 Package quantity: ø6 - ø19.9 = 2 pcs.
 ø20 - ø25.4 = 1 pc.



DRILL HEAD

DMP

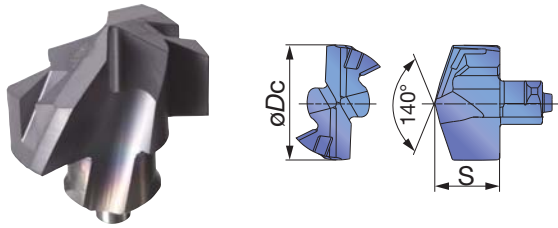

Designation	ϕD_c (in)	ϕD_c (mm)	AH725	S (mm)	Pocket size	Body
DMP255	1.004	25.5	●	14.3	25	TID*250...
DMP256	1.008	25.6	●	14.3	25	TID*250...
DMP257	1.012	25.7	●	14.3	25	TID*250...
DMP258	1.016	25.8	●	14.3	25	TID*250...
DMP259	1.020	25.9	●	14.3	25	TID*250...

- Additional sizes to 1.020" (25.9 mm) DMP 200 ~ 259 is corresponding drill bodies on page E006, E008, E010, E012.

Head diameter (Inch)	Head diameter tolerance
$\phi 0.236'' - \phi 0.705''$	+0.0007" / 0
$\phi 0.709'' - \phi 1.020''$	+0.0008" / 0

Head diameter (mm)	Head diameter tolerance
$\phi 6 - \phi 17.9$	+0.018 / 0
$\phi 18 - \phi 25.9$	+0.021 / 0

● : Line up
Package quantity: $\phi 25.5 - \phi 25.9 = 1$ pc.

STANDARD CUTTING CONDITIONS

ISO	Workpiece material	Cutting speed Vc (sfm)	Feed: f (ipr)				
			ϕD_c (in)				
			$\phi 0.393 - \phi 0.468$	$\phi 0.472 - \phi 0.547$	$\phi 0.551 - \phi 0.625$	$\phi 0.629 - \phi 0.783$	$\phi 0.787 - \phi 1.020$
P	Low carbon steel (C < 0.3) 1018, 1020, 1026, etc.	260 - 450	0.006 - 0.011	0.007 - 0.012	0.008 - 0.014	0.01 - 0.017	0.01 - 0.018
	High carbon steel (C > 0.3) 1045, 1055, etc.	230 - 400	0.006 - 0.011	0.007 - 0.012	0.008 - 0.014	0.01 - 0.017	0.01 - 0.018
	Low alloy steel 5120, etc.	230 - 400	0.005 - 0.011	0.006 - 0.012	0.007 - 0.014	0.009 - 0.015	0.01 - 0.018
	Alloy steel 4140, 8620, etc.	130 - 300	0.005 - 0.011	0.006 - 0.012	0.007 - 0.013	0.009 - 0.015	0.01 - 0.018
M	Stainless steel 304SS, 316SS, 17-4PH, etc.	100 - 230	0.004 - 0.007	0.005 - 0.008	0.006 - 0.009	0.006 - 0.010	0.007 - 0.012
K	Gray cast iron Class 25, Class 30, etc.	260 - 600	0.008 - 0.014	0.010 - 0.015	0.011 - 0.017	0.014 - 0.021	0.014 - 0.024
	Ductile cast iron 60-40-18, 60-55-06, etc.	260 - 450	0.008 - 0.014	0.010 - 0.015	0.011 - 0.017	0.014 - 0.021	0.014 - 0.024
N	Aluminum alloys 6061, 7075, etc.	260 - 720	0.010 - 0.015	0.011 - 0.017	0.014 - 0.020	0.015 - 0.024	0.02 - 0.03
S	Titanium alloys Ti-6Al-4V, etc.	65 - 160	0.003 - 0.006	0.004 - 0.011	0.005 - 0.008	0.006 - 0.009	0.007 - 0.011
	Nickel-based alloys	65 - 160	0.003 - 0.006	0.004 - 0.006	0.005 - 0.007	0.006 - 0.009	0.006 - 0.009

- Cutting conditions in the above table show standard cutting conditions.
- Cutting conditions may change due to the rigidity and power of the machine and the workpiece material.

- Machined hole diameter may change depending upon the rigidity of the machine tool or cutting conditions.
- In case of L/D = 8,12 drill, the recommended range of cutting speeds and feeds is between the minimum and median values listed above.

TECHNICAL GUIDELINES

● **When to change drill heads (Criteria for the end of tool life)**

The criteria to identify the time for tool change are as follows:

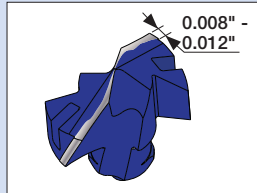

Width of corner wear reaches 0.008" - 0.012".

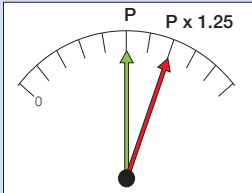

Spindle load exceeds 125% of the normal value.

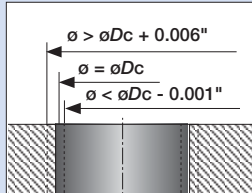

Hole diameter is 0.006" larger or 0.001" smaller than the drill diameter.

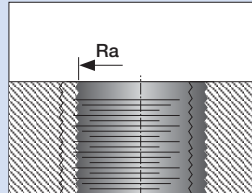

Surface roughness deteriorates.



Vibration or unusual noise occurs.

● **How to clamp the drill head**

① **Clean and lubricate the pocket.**

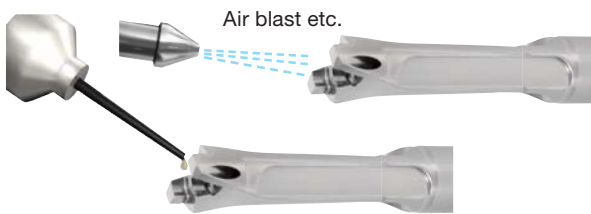

② **Set the drill head into the pocket.**



③ **Set the clamping key on the drill head**

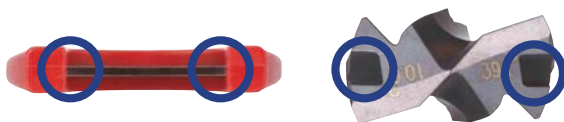

④ **Clamp**



● **Coolant supply**

Internal coolant supply is recommended.



■ **The required coolant flow and pressure**

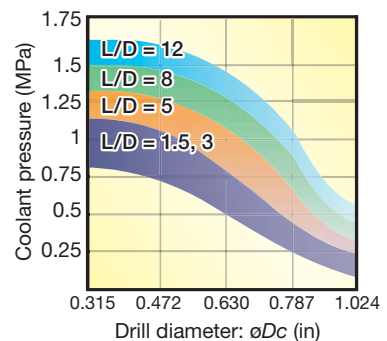
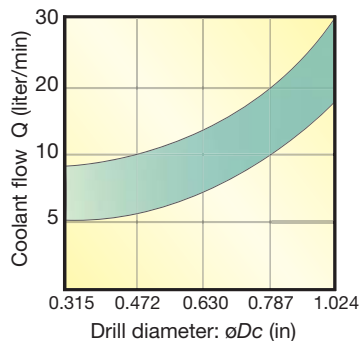



● Applications that are not recommended

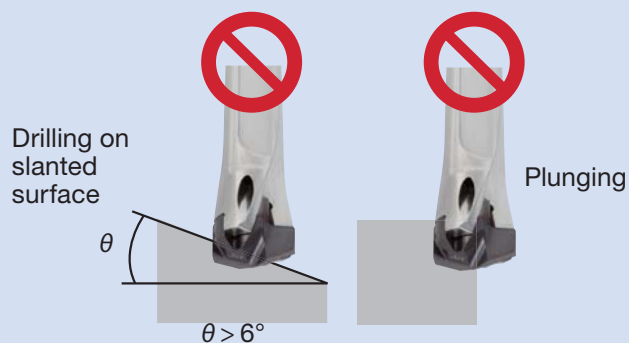

● Run-out

Run-out should be less than 0.0008".

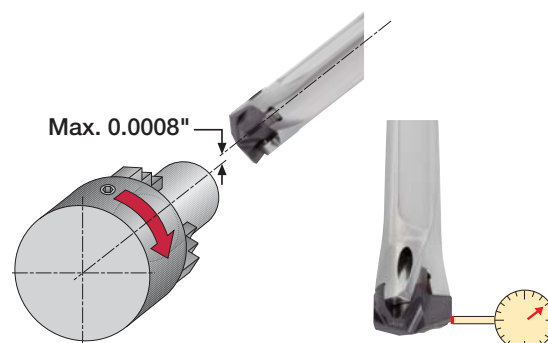

Ideal : $\leq 0.0008"$
 Acceptable : $\leq 0.002"$
 Not acceptable : $> 0.002"$

INSTRUCTION OF CLAMPING HEAD

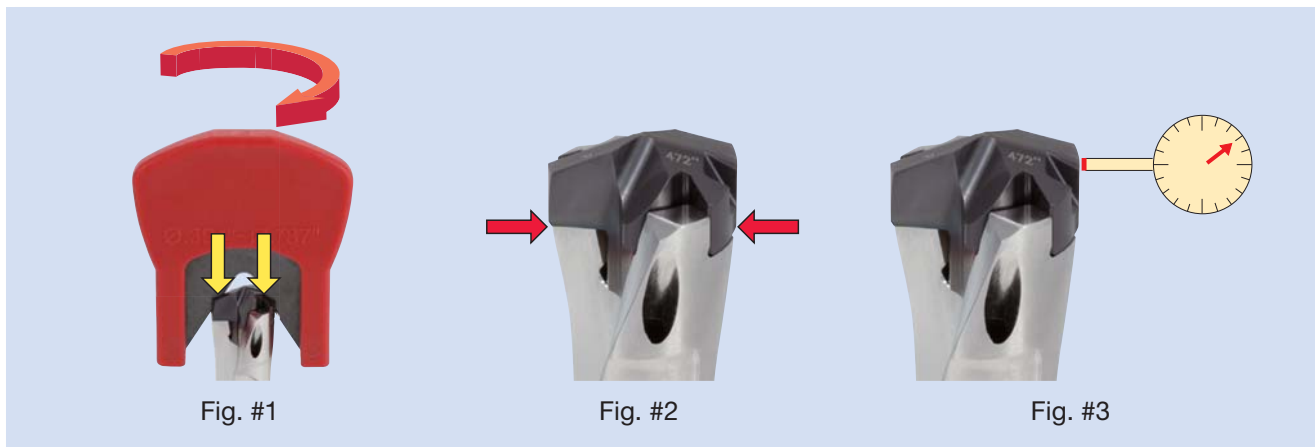

Procedure

- ① Clean the clamping areas on the drill body and the head with an air blast, lubricate them, and put the drill head in the pocket.
- ② Set the clamping key in the groove on the drill head. Push the head toward the pocket with equal torque on the right and the left sides, and turn the clamping key to clamp the head completely. (Fig. #1)
- ③ Be sure that there is no gap between the bottom of the head and the drill body. A shim in the thickness of around 0.0004" is useful to check the gap. (Fig. #2)
- ④ If there is a gap thicker than 0.0004", unclamp the head and return to the procedure No. ①
- ⑤ Check the run-out at the margin of the drill head. Run-out must be less than 0.00196". (Fig. #3) (Recommended value: less than 0.00787")
 If the run-out exceeds 0.00196", unclamp the head and return to the procedure No. ① .

Note #1: If the clamping torque is not equally applied on the right and the left sides of the drill head, there may be a gap between the head and the body, which increases the run-out of the head.

Note #2: The low accuracy in holding the drill body may affect the run-out. If the run-out is large, check the accuracy in holding the drill body.

HOW TO MOUNT THE TIDC DRILL BODY INTO THE CHAMFER ADAPTOR

The overhang length of the drill can be changed by the adjusting screw at the bottom of the adaptor.
The rear end of the drill body must be in contact with the adjusting screw as the screw supports the drill against thrust force when drilling.

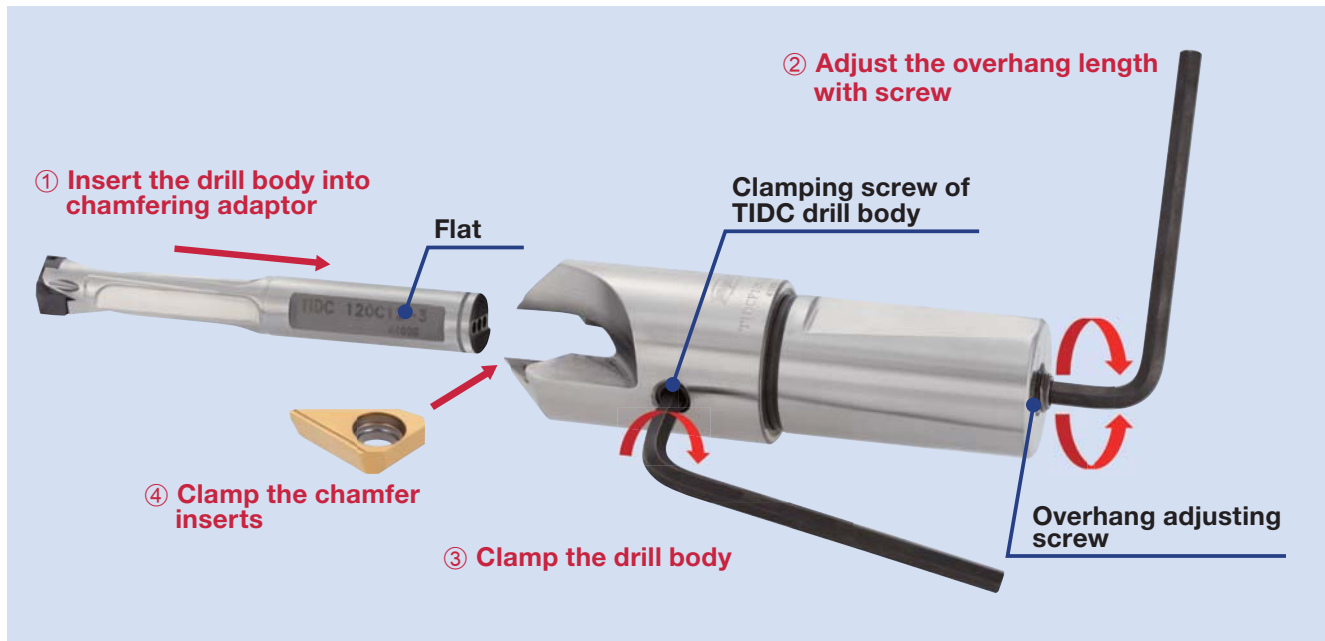

Procedure

- ① Place the TIDC drill body into the chamfer adaptor without chamfer inserts.
- ② Adjust the overhang length of the drill body with the adjusting screw at the bottom of the adaptor.
- ③ Adjust the position of the drill body so that the drill body is fixed at the flat and tighten the clamping screw of the drill body. This aligns the flutes of the TIDC drill body with the chamfer inserts.
- ④ To clamp the chamfer inserts, tighten the clamping screw of the insert while pushing the insert into the insert pocket.

Notice

Before removing the drill body from the adaptor, chamfer inserts must be unclamped.

The overhang adjusting screw can be handled from the top of the adaptor with flat-blade screwdriver. In this way, the overhang length of the drill body can be adjusted after the adaptor is positioned on the drill shank.

CAUTION FOR USING DRILLS WITH $L/D = 8, 12$

Prior to using the drill with $L/D = 8, 12$ a pilot hole should be drilled with a short or centering drill.

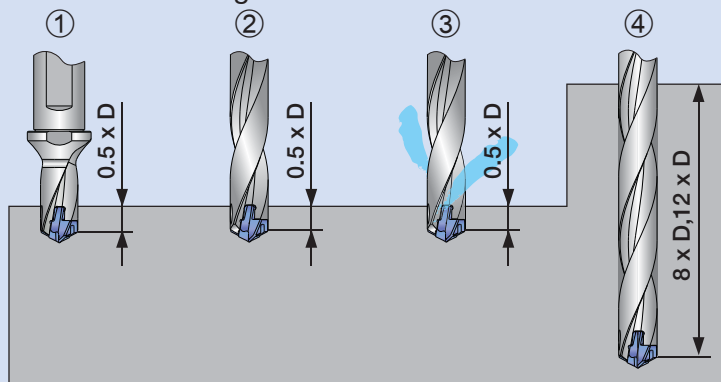



2-effective Drill

DRILL FORCE MEISTER

TIS L/D=3

Head indexable large drill

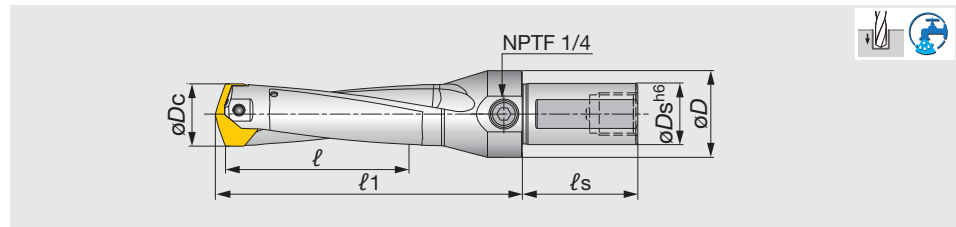

Inch	$\varnothing D_c$	$\varnothing D_s$	$\varnothing D$	ℓ	ℓ_1	ℓ_s	Pocket size	Coolant	Head
TISU1024F1250-3	1.024 - 1.059	1.250	1.772	3.071	5.315	2.362	26	Y	SMP26*
TISU1063F1250-3	1.063 - 1.098	1.250	1.772	3.189	5.453	2.362	27	Y	SMP27*
TISU1102F1250-3	1.102 - 1.138	1.250	1.772	3.307	5.606	2.362	28	Y	SMP28*
TISU1142F1250-3	1.142 - 1.177	1.250	1.772	3.425	5.744	2.362	29	Y	SMP29*
TISU1181F1250-3	1.181 - 1.217	1.250	1.772	3.543	5.894	2.362	30	Y	SMP30*
TISU1220F1250-3	1.220 - 1.256	1.250	1.772	3.661	6.031	2.362	31	Y	SMP31*
TISU1260F1500-3	1.260 - 1.295	1.500	2.165	3.780	6.378	2.677	32	Y	SMP32*
TISU1299F1500-3	1.299 - 1.335	1.500	2.165	3.898	6.516	2.677	33	Y	SMP33*
TISU1339F1500-3	1.339 - 1.374	1.500	2.165	4.016	6.654	2.677	34	Y	SMP34*
TISU1378F1500-3	1.378 - 1.413	1.500	2.165	4.134	6.807	2.677	35	Y	SMP35*
TISU1417F1500-3	1.417 - 1.453	1.500	2.165	4.252	6.945	2.677	36	Y	SMP36*
TISU1457F1500-3	1.457 - 1.492	1.500	2.165	4.370	7.083	2.677	37	Y	SMP37*
TISU1496F1500-3	1.496 - 1.531	1.500	2.165	4.488	7.240	2.677	38	Y	SMP38*
TISU1535F1500-3	1.535 - 1.571	1.500	2.165	4.606	7.378	2.677	39	Y	SMP39*
TISU1575F1500-3	1.575 - 1.614	1.500	2.165	4.724	7.516	2.677	40	Y	SMP40*

Tool diameter	Hole diameter tolerance*
$\varnothing 1.024 - \varnothing 1.142$	+0.0020 / 0
$\varnothing 1.181 - \varnothing 1.614$	+0.0024 / 0

*Just for reference

SPARE PARTS

Designation	Clamping screw	Torx Bit	Grip	Screw for side port	Plug * (Optional parts)
TISU1024F1250-3	TS50230D3	BLDT20/S7	H-TB2W	NPTF1/4	(SL32IN)
TISU1063F1250-3	TS50230D3	BLDT20/S7	H-TB2W	NPTF1/4	(SL32IN)
TISU1102F1250-3	TS50250D35	BLDT25/S7	H-TB2W	NPTF1/4	(SL32IN)
TISU1142F1250-3	TS50250D35	BLDT25/S7	H-TB2W	NPTF1/4	(SL32IN)
TISU1181F1250-3	TS60265D4	BLDT25/S7	H-TB2W	NPTF1/4	(SL32IN)
TISU1220F1250-3	TS60265D4	BLDT25/S7	H-TB2W	NPTF1/4	(SL32IN)
TISU1260F1500-3	TS60285D42	BLDT25/S7	H-TB2W	NPTF1/4	(SL38IN)
TISU1299F1500-3	TS60285D42	BLDT25/S7	H-TB2W	NPTF1/4	(SL38IN)
TISU1339F1500-3	TS60285D42	BLDT25/S7	H-TB2W	NPTF1/4	(SL38IN)
TISU1378F1500-3	TS60320D5	BLDT25/S7	H-TB2W	NPTF1/4	(SL38IN)
TISU1417F1500-3	TS60320D5	BLDT25/S7	H-TB2W	NPTF1/4	(SL38IN)
TISU1457F1500-3	TS60320D5	BLDT25/S7	H-TB2W	NPTF1/4	(SL38IN)
TISU1496F1500-3	TS80340D6	BLDT25/S7	H-TB2W	NPTF1/4	(SL38IN)
TISU1535F1500-3	TS80340D6	BLDT25/S7	H-TB2W	NPTF1/4	(SL38IN)
TISU1575F1500-3	TS80340D6	BLDT25/S7	H-TB2W	NPTF1/4	(SL38IN)

*Inner thread size: NPTF1/4

Reference pages

Head → E026 - E027, Standard cutting conditions → E028

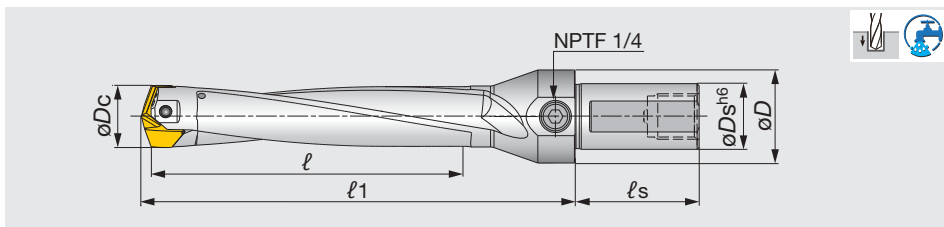

Inch	$\varnothing D_c$	$\varnothing D_s$	$\varnothing D$	ℓ	ℓ_1	ℓ_s	Pocket size	Coolant	Head
TISU1024F1250-5	1.024 - 1.059	1.250	1.772	5.118	7.362	2.362	26	Y	SMP26*
TISU1063F1250-5	1.063 - 1.098	1.250	1.772	5.315	7.579	2.362	27	Y	SMP27*
TISU1102F1250-5	1.102 - 1.138	1.250	1.772	5.512	7.811	2.362	28	Y	SMP28*
TISU1142F1250-5	1.142 - 1.177	1.250	1.772	5.709	8.028	2.362	29	Y	SMP29*
TISU1181F1250-5	1.181 - 1.217	1.250	1.772	5.906	8.256	2.362	30	Y	SMP30*
TISU1220F1250-5	1.220 - 1.256	1.250	1.772	6.102	8.472	2.362	31	Y	SMP31*
TISU1260F1500-5	1.260 - 1.295	1.500	2.165	6.299	8.898	2.677	32	Y	SMP32*
TISU1299F1500-5	1.299 - 1.335	1.500	2.165	6.496	9.114	2.677	33	Y	SMP33*
TISU1339F1500-5	1.339 - 1.374	1.500	2.165	6.693	9.331	2.677	34	Y	SMP34*
TISU1378F1500-5	1.378 - 1.413	1.500	2.165	6.890	9.563	2.677	35	Y	SMP35*
TISU1417F1500-5	1.417 - 1.453	1.500	2.165	7.087	9.780	2.677	36	Y	SMP36*
TISU1457F1500-5	1.457 - 1.492	1.500	2.165	7.283	9.996	2.677	37	Y	SMP37*
TISU1496F1500-5	1.496 - 1.531	1.500	2.165	7.480	10.232	2.677	38	Y	SMP38*
TISU1535F1500-5	1.535 - 1.571	1.500	2.165	7.677	10.449	2.677	39	Y	SMP39*
TISU1575F1500-5	1.575 - 1.614	1.500	2.165	7.874	10.665	2.677	40	Y	SMP40*

Tool diameter	Hole diameter tolerance*
$\varnothing 1.024 - \varnothing 1.142$	+0.003 / 0
$\varnothing 1.181 - \varnothing 1.614$	+0.0035 / 0

*Just for reference

SPARE PARTS



Designation	Clamping screw	Torx Bit	Grip	Screw for side port	Plug * (Optional parts)
TISU1024F1250-5	TS50230D3	BLDT20/S7	H-TB2W	NPTF1/4	(SL32IN)
TISU1063F1250-5	TS50230D3	BLDT20/S7	H-TB2W	NPTF1/4	(SL32IN)
TISU1102F1250-5	TS50250D35	BLDT25/S7	H-TB2W	NPTF1/4	(SL32IN)
TISU1142F1250-5	TS50250D35	BLDT25/S7	H-TB2W	NPTF1/4	(SL32IN)
TISU1181F1250-5	TS60265D4	BLDT25/S7	H-TB2W	NPTF1/4	(SL32IN)
TISU1220F1250-5	TS60265D4	BLDT25/S7	H-TB2W	NPTF1/4	(SL32IN)
TISU1260F1500-5	TS60285D42	BLDT25/S7	H-TB2W	NPTF1/4	(SL38IN)
TISU1299F1500-5	TS60285D42	BLDT25/S7	H-TB2W	NPTF1/4	(SL38IN)
TISU1339F1500-5	TS60285D42	BLDT25/S7	H-TB2W	NPTF1/4	(SL38IN)
TISU1378F1500-5	TS60320D5	BLDT25/S7	H-TB2W	NPTF1/4	(SL38IN)
TISU1417F1500-5	TS60320D5	BLDT25/S7	H-TB2W	NPTF1/4	(SL38IN)
TISU1457F1500-5	TS60320D5	BLDT25/S7	H-TB2W	NPTF1/4	(SL38IN)
TISU1496F1500-5	TS80340D6	BLDT25/S7	H-TB2W	NPTF1/4	(SL38IN)
TISU1535F1500-5	TS80340D6	BLDT25/S7	H-TB2W	NPTF1/4	(SL38IN)
TISU1575F1500-5	TS80340D6	BLDT25/S7	H-TB2W	NPTF1/4	(SL38IN)

*Inner thread size: NPTF1/4

Reference pages

Head → E026 - E027, Standard cutting conditions → E028



DRILL HEAD

SMP

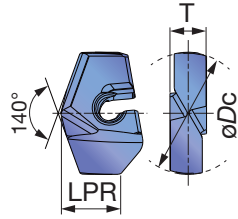
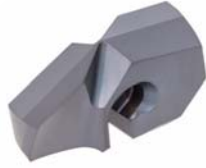

Designation	øDc (in)	øDc (mm)	AH725	T (in)	LPR (in)	Pocket size	Body
SMP260	1.024	26	●	0.295	0.457	26	TISU1024F1250-*
SMP261	1.028	26.1	●	0.295	0.457	26	TISU1024F1250-*
SMP265	1.043	26.5	●	0.295	0.457	26	TISU1024F1250-*
SMP267	1.051	26.7	●	0.295	0.457	26	TISU1024F1250-*
SMP270	1.063	27	●	0.295	0.437	27	TISU1063F1250-*
SMP271	1.067	27.1	●	0.295	0.437	27	TISU1063F1250-*
SMP272	1.071	27.2	●	0.295	0.437	27	TISU1063F1250-*
SMP275	1.083	27.5	●	0.295	0.437	27	TISU1063F1250-*
SMP280	1.102	28	●	0.315	0.461	28	TISU1102F1250-*
SMP281	1.106	28.1	●	0.315	0.461	28	TISU1102F1250-*
SMP285	1.122	28.5	●	0.315	0.461	28	TISU1102F1250-*
SMP286	1.126	28.6	●	0.315	0.461	28	TISU1102F1250-*
SMP290	1.142	29	●	0.315	0.445	29	TISU1142F1250-*
SMP291	1.146	29.1	●	0.315	0.445	29	TISU1142F1250-*
SMP295	1.161	29.5	●	0.315	0.445	29	TISU1142F1250-*
SMP296	1.165	29.6	●	0.315	0.445	29	TISU1142F1250-*
SMP300	1.181	30	●	0.335	0.555	30	TISU1181F1250-*
SMP301	1.185	30.1	●	0.335	0.555	30	TISU1181F1250-*
SMP302	1.189	30.2	●	0.335	0.555	30	TISU1181F1250-*
SMP303	1.193	30.3	●	0.335	0.555	30	TISU1181F1250-*
SMP305	1.201	30.5	●	0.335	0.555	30	TISU1181F1250-*
SMP308	1.213	30.8	●	0.335	0.555	30	TISU1181F1250-*
SMP310	1.220	31	●	0.335	0.539	31	TISU1220F1250-*
SMP311	1.224	31.1	●	0.335	0.539	31	TISU1220F1250-*
SMP315	1.240	31.5	●	0.335	0.539	31	TISU1220F1250-*
SMP318	1.252	31.8	●	0.335	0.539	31	TISU1220F1250-*
SMP320	1.260	32	●	0.354	0.571	32	TISU1260F1250-*
SMP321	1.264	32.1	●	0.354	0.571	32	TISU1260F1250-*
SMP325	1.280	32.5	●	0.354	0.571	32	TISU1260F1250-*
SMP328	1.291	32.8	●	0.354	0.571	32	TISU1260F1250-*
SMP330	1.299	33	●	0.354	0.555	33	TISU1299F1250-*
SMP331	1.303	33.1	●	0.354	0.555	33	TISU1299F1250-*
SMP333	1.311	33.3	●	0.354	0.555	33	TISU1299F1250-*
SMP335	1.319	33.5	●	0.354	0.555	33	TISU1299F1250-*
SMP340	1.339	34	●	0.354	0.539	34	TISU1339F1250-*
SMP341	1.343	34.1	●	0.354	0.539	34	TISU1339F1250-*
SMP345	1.358	34.5	●	0.354	0.539	34	TISU1339F1250-*
SMP349	1.374	34.9	●	0.354	0.539	34	TISU1339F1250-*
SMP350	1.378	35	●	0.394	0.654	35	TISU1378F1250-*
SMP351	1.382	35.1	●	0.394	0.654	35	TISU1378F1250-*
SMP355	1.398	35.5	●	0.394	0.654	35	TISU1378F1250-*
SMP360	1.417	36	●	0.394	0.634	36	TISU1417F1250-*
SMP361	1.421	36.1	●	0.394	0.634	36	TISU1417F1250-*
SMP365	1.437	36.5	●	0.394	0.634	36	TISU1417F1250-*
SMP366	1.441	36.6	●	0.394	0.634	36	TISU1417F1250-*
SMP370	1.457	37	●	0.394	0.618	37	TISU1457F1250-*
SMP371	1.461	37.1	●	0.394	0.618	37	TISU1457F1250-*
SMP375	1.476	37.5	●	0.394	0.634	37	TISU1457F1250-*
SMP380	1.496	38	●	0.413	0.669	38	TISU1496F1250-*
SMP381	1.500	38.1	●	0.413	0.669	38	TISU1496F1250-*

● : Line up
Package quantity =1pc



Designation	ϕD_c (in)	ϕD_c (mm)	AH725	T (in)	LPR (in)	Pocket size	Body
SMP385	1.516	38.5	●	0.413	0.669	38	TISU1496F1250-*
SMP388	1.528	38.8	●	0.413	0.669	38	TISU1496F1250-*
SMP390	1.535	39	●	0.413	0.653	39	TISU1535F1250-*
SMP391	1.539	39.1	●	0.413	0.653	39	TISU1535F1250-*
SMP395	1.555	39.5	●	0.413	0.653	39	TISU1535F1250-*
SMP397	1.563	39.7	●	0.413	0.653	39	TISU1535F1250-*
SMP398	1.567	39.8	●	0.413	0.653	39	TISU1535F1250-*
SMP400	1.575	40	●	0.413	0.637	40	TISU1575F1250-*
SMP401	1.579	40.1	●	0.413	0.637	40	TISU1575F1250-*
SMP405	1.594	40.5	●	0.413	0.637	40	TISU1575F1250-*
SMP410	1.614	41	●	0.413	0.637	40	TISU1575F1250-*

Tool diameter (Inch)	Head diameter tolerance
$\phi 1.024'' - \phi 1.142''$	-0.0002" / -0.0010"
$\phi 1.181'' - \phi 1.575''$	-0.0002" / -0.0012"

Tool diameter (mm)	Head diameter tolerance
$\phi 26 - \phi 29.9$	-0.006 / -0.026
$\phi 30 - \phi 41$	-0.006 / -0.031

● : Line up
Package quantity =1pc

STANDARD CUTTING CONDITIONS

ISO	Workpiece material	Cutting speed Vc (sfm)	Feed: f (ipr)		
			øDc (in)		
			ø1.024 - ø1.177	ø1.181 - ø1.403	ø1.417 - ø1.614
P	Low carbon steels 1018, 1020, 1026, etc.	262 - 459	0.008 - 0.02	0.008 - 0.02	0.01 - 0.022
	Carbon steels, Alloy steels 1045, 1055, etc.	262 - 427	0.008 - 0.02	0.008 - 0.02	0.01 - 0.022
	Prehardened steels NAK80, PX5, etc.	164 - 328	0.008 - 0.02	0.008 - 0.02	0.01 - 0.022
M	Stainless steels 304SS, 316SS, 17-4 PH, etc.	131 - 262	0.006 - 0.012	0.006 - 0.012	0.008 - 0.014
K	Gray cast irons Class 25, Class 30, etc.	262 - 591	0.01 - 0.022	0.01 - 0.022	0.012 - 0.024
	Ductile cast irons 60-40-18, 80-55-06, etc.	262 - 459	0.01 - 0.022	0.01 - 0.022	0.012 - 0.024
N	Non ferrous materials	328 - 722	0.016 - 0.024	0.016 - 0.024	0.02 - 0.028
S	Heat-resistant alloys Inconel718, etc.	66 - 164	0.004 - 0.008	0.004 - 0.008	0.004 - 0.01
	Titanium alloys Ti-6Al-4V, etc.	98 - 197	0.004 - 0.008	0.004 - 0.008	0.004 - 0.01
H	Hardened materials	66 - 197	0.004 - 0.008	0.004 - 0.008	0.004 - 0.01

RECOMMENDED COOLANT PRESSURE AND VOLUME

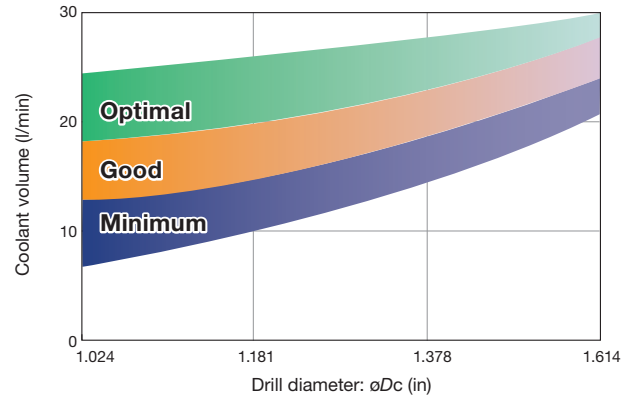
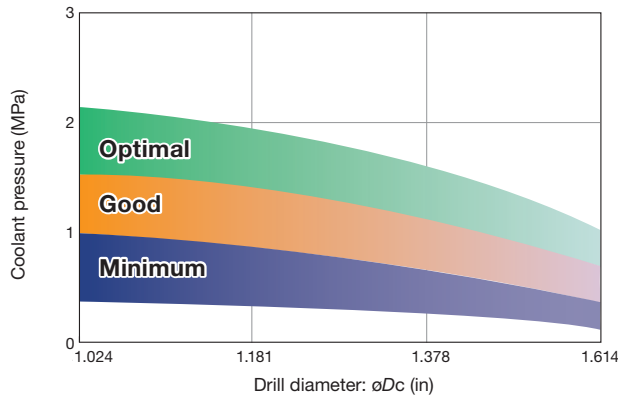

HOW TO CHANGE DRILL HEAD

To unclamp rotate the screw 3-5 times counter-clockwise.

No need to remove the screw from the body.



- Please change the screw to a new one when the screw does not rotate smoothly

SolidDrill Quick Guide



2-effective Drill

Series	ød (Inch/mm)	L/D	Point Angle	Oil Hole	Coated	Un coated	Description	P	M	K	N	S	H	See page
								Steel	Stainless	Cast iron	Non-ferrous	Superalloys	Hard materials	
DSM DSM-CP	ø0.1 - ø3 mm	5, 10, 15	140 90 & 140		●		Micro solid drill with ø3 mm shanks DSM-CP: Centering drill for DSM	●	●	●	●	●	●	E050 - E053
DSW	ø3 - ø16 mm	3, 5, 8	140	With, Without	●		Shank size: DIN	●	●	●	●	●	●	E030 - E038
DSXU DSX	ø0.125" - ø0.781" (ø3 - ø20 mm)	3, 5, 8	140	With	●		Shank size: 1/64" increments	●	●	●	●	●	●	E042 - E049
DMXU DMX	ø0.111" - ø0.781" (ø3 - ø16 mm)	2, 3	130		●		Shank size: Same as the drill diameter	●	●	●	●	●	●	E054 - E059
FDS	ø2.57 - ø11 mm	3	135			●	Drills for reaming pre-tap holes with straight flute			●	●			E060 - E061
FDC FDCU	ø0.2031" - ø0.6250" (ø5 - ø16 mm)	5, 8	135	With		●	Drills for reaming at high feed with straight flute			●	●			E062 - E065

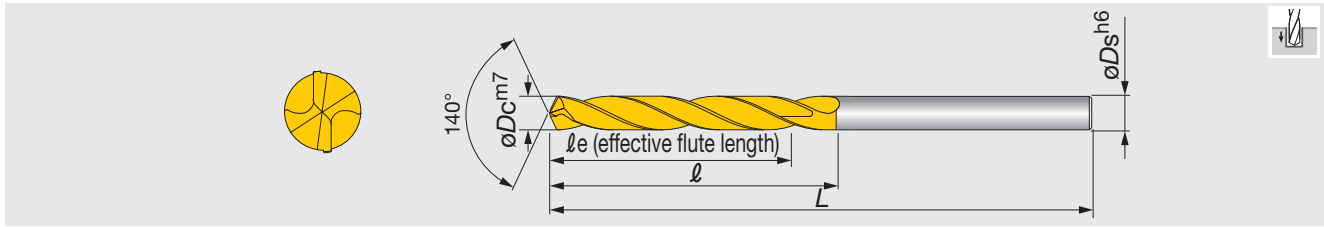

Metric	øDc	AH725	øDs	le	l	L	Metric	øDc	AH725	øDs	le	l	L
DSW030-014-06DE3	3	●	6	14	20	62	DSW078-029-08DE3	7.8	●	8	29	41	79
DSW031-014-06DE3	3.1	●	6	14	20	62	DSW079-029-08DE3	7.9	●	8	29	41	79
DSW032-014-06DE3	3.2	●	6	14	20	62	DSW080-029-08DE3	8	●	8	29	41	79
DSW033-014-06DE3	3.3	●	6	14	20	62	DSW081-035-10DE3	8.1	●	10	35	47	89
DSW034-014-06DE3	3.4	●	6	14	20	62	DSW082-035-10DE3	8.2	●	10	35	47	89
DSW035-014-06DE3	3.5	●	6	14	20	62	DSW083-035-10DE3	8.3	●	10	35	47	89
DSW036-014-06DE3	3.6	●	6	14	20	62	DSW084-035-10DE3	8.4	●	10	35	47	89
DSW037-014-06DE3	3.7	●	6	14	20	62	DSW085-035-10DE3	8.5	●	10	35	47	89
DSW038-017-06DE3	3.8	●	6	17	24	66	DSW086-035-10DE3	8.6	●	10	35	47	89
DSW039-017-06DE3	3.9	●	6	17	24	66	DSW087-035-10DE3	8.7	●	10	35	47	89
DSW040-017-06DE3	4	●	6	17	24	66	DSW088-035-10DE3	8.8	●	10	35	47	89
DSW041-017-06DE3	4.1	●	6	17	24	66	DSW089-035-10DE3	8.9	●	10	35	47	89
DSW042-017-06DE3	4.2	●	6	17	24	66	DSW090-035-10DE3	9	●	10	35	47	89
DSW043-017-06DE3	4.3	●	6	17	24	66	DSW091-035-10DE3	9.1	●	10	35	47	89
DSW044-017-06DE3	4.4	●	6	17	24	66	DSW092-035-10DE3	9.2	●	10	35	47	89
DSW045-017-06DE3	4.5	●	6	17	24	66	DSW093-035-10DE3	9.3	●	10	35	47	89
DSW046-017-06DE3	4.6	●	6	17	24	66	DSW094-035-10DE3	9.4	●	10	35	47	89
DSW047-017-06DE3	4.7	●	6	17	24	66	DSW095-035-10DE3	9.5	●	10	35	47	89
DSW048-020-06DE3	4.8	●	6	20	28	66	DSW096-035-10DE3	9.6	●	10	35	47	89
DSW049-020-06DE3	4.9	●	6	20	28	66	DSW097-035-10DE3	9.7	●	10	35	47	89
DSW050-020-06DE3	5	●	6	20	28	66	DSW098-035-10DE3	9.8	●	10	35	47	89
DSW051-020-06DE3	5.1	●	6	20	28	66	DSW099-035-10DE3	9.9	●	10	35	47	89
DSW052-020-06DE3	5.2	●	6	20	28	66	DSW100-035-10DE3	10	●	10	35	47	89
DSW053-020-06DE3	5.3	●	6	20	28	66	DSW101-040-12DE3	10.1	●	12	40	55	102
DSW054-020-06DE3	5.4	●	6	20	28	66	DSW102-040-12DE3	10.2	●	12	40	55	102
DSW055-020-06DE3	5.5	●	6	20	28	66	DSW103-040-12DE3	10.3	●	12	40	55	102
DSW056-020-06DE3	5.6	●	6	20	28	66	DSW104-040-12DE3	10.4	●	12	40	55	102
DSW057-020-06DE3	5.7	●	6	20	28	66	DSW105-040-12DE3	10.5	●	12	40	55	102
DSW058-020-06DE3	5.8	●	6	20	28	66	DSW106-040-12DE3	10.6	●	12	40	55	102
DSW059-020-06DE3	5.9	●	6	20	28	66	DSW107-040-12DE3	10.7	●	12	40	55	102
DSW060-020-06DE3	6	●	6	20	28	66	DSW108-040-12DE3	10.8	●	12	40	55	102
DSW061-024-08DE3	6.1	●	8	24	34	79	DSW109-040-12DE3	10.9	●	12	40	55	102
DSW062-024-08DE3	6.2	●	8	24	34	79	DSW110-040-12DE3	11	●	12	40	55	102
DSW063-024-08DE3	6.3	●	8	24	34	79	DSW111-040-12DE3	11.1	●	12	40	55	102
DSW064-024-08DE3	6.4	●	8	24	34	79	DSW112-040-12DE3	11.2	●	12	40	55	102
DSW065-024-08DE3	6.5	●	8	24	34	79	DSW113-040-12DE3	11.3	●	12	40	55	102
DSW066-024-08DE3	6.6	●	8	24	34	79	DSW114-040-12DE3	11.4	●	12	40	55	102
DSW067-024-08DE3	6.7	●	8	24	34	79	DSW115-040-12DE3	11.5	●	12	40	55	102
DSW068-024-08DE3	6.8	●	8	24	34	79	DSW116-040-12DE3	11.6	●	12	40	55	102
DSW069-024-08DE3	6.9	●	8	24	34	79	DSW117-040-12DE3	11.7	●	12	40	55	102
DSW070-024-08DE3	7	●	8	24	34	79	DSW118-040-12DE3	11.8	●	12	40	55	102
DSW071-029-08DE3	7.1	●	8	29	41	79	DSW119-040-12DE3	11.9	●	12	40	55	102
DSW072-029-08DE3	7.2	●	8	29	41	79	DSW120-040-12DE3	12	●	12	40	55	102
DSW073-029-08DE3	7.3	●	8	29	41	79	DSW121-043-14DE3	12.1	●	14	43	60	107
DSW074-029-08DE3	7.4	●	8	29	41	79	DSW122-043-14DE3	12.2	●	14	43	60	107
DSW075-029-08DE3	7.5	●	8	29	41	79	DSW123-043-14DE3	12.3	●	14	43	60	107
DSW076-029-08DE3	7.6	●	8	29	41	79	DSW124-043-14DE3	12.4	●	14	43	60	107
DSW077-029-08DE3	7.7	●	8	29	41	79	DSW125-043-14DE3	12.5	●	14	43	60	107

● : Line up



Metric	ϕD_c	AH725	ϕD_s	ℓ_e	ℓ	L
DSW126-043-14DE3	12.6	●	14	43	60	107
DSW127-043-14DE3	12.7	●	14	43	60	107
DSW128-043-14DE3	12.8	●	14	43	60	107
DSW129-043-14DE3	12.9	●	14	43	60	107
DSW130-043-14DE3	13	●	14	43	60	107
DSW131-043-14DE3	13.1	●	14	43	60	107
DSW132-043-14DE3	13.2	●	14	43	60	107
DSW133-043-14DE3	13.3	●	14	43	60	107
DSW134-043-14DE3	13.4	●	14	43	60	107
DSW135-043-14DE3	13.5	●	14	43	60	107
DSW136-043-14DE3	13.6	●	14	43	60	107
DSW137-043-14DE3	13.7	●	14	43	60	107
DSW138-043-14DE3	13.8	●	14	43	60	107
DSW139-043-14DE3	13.9	●	14	43	60	107
DSW140-043-14DE3	14	●	14	43	60	107
DSW141-045-16DE3	14.1	●	16	45	65	115
DSW142-045-16DE3	14.2	●	16	45	65	115
DSW143-045-16DE3	14.3	●	16	45	65	115
DSW144-045-16DE3	14.4	●	16	45	65	115
DSW145-045-16DE3	14.5	●	16	45	65	115
DSW146-045-16DE3	14.6	●	16	45	65	115
DSW147-045-16DE3	14.7	●	16	45	65	115
DSW148-045-16DE3	14.8	●	16	45	65	115
DSW149-045-16DE3	14.9	●	16	45	65	115
DSW150-045-16DE3	15	●	16	45	65	115
DSW151-045-16DE3	15.1	●	16	45	65	115
DSW152-045-16DE3	15.2	●	16	45	65	115
DSW153-045-16DE3	15.3	●	16	45	65	115
DSW154-045-16DE3	15.4	●	16	45	65	115
DSW155-045-16DE3	15.5	●	16	45	65	115
DSW156-045-16DE3	15.6	●	16	45	65	115
DSW157-045-16DE3	15.7	●	16	45	65	115
DSW158-045-16DE3	15.8	●	16	45	65	115
DSW159-045-16DE3	15.9	●	16	45	65	115
DSW160-045-16DE3	16	●	16	45	65	115

● : Line up

Reference pages

Standard cutting conditions → E038



SOLIDDRILL

DSW-DE5

Solidrill with 140° point angle without oil hole & DIN shank, L/D = 5, dia = ø3 - ø16 mm

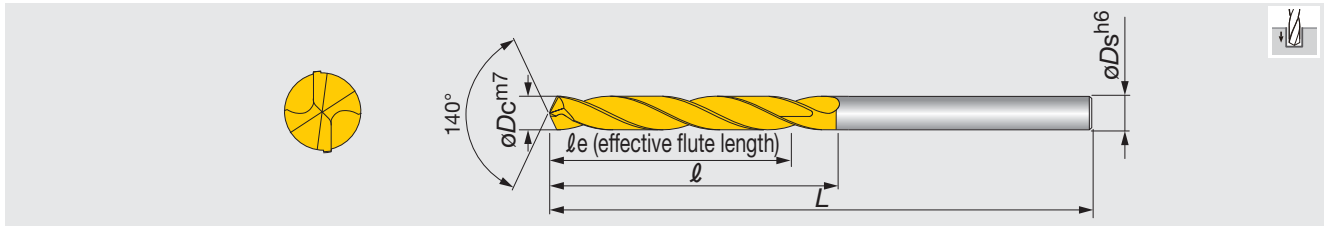

Metric	øDc	AH725	øDs	le	l	L	Metric	øDc	AH725	øDs	le	l	L
DSW030-023-06DE5	3	●	6	23	28	66	DSW078-043-08DE5	7.8	●	8	43	53	91
DSW031-023-06DE5	3.1	●	6	23	28	66	DSW079-043-08DE5	7.9	●	8	43	53	91
DSW032-023-06DE5	3.2	●	6	23	28	66	DSW080-043-08DE5	8	●	8	43	53	91
DSW033-023-06DE5	3.3	●	6	23	28	66	DSW081-049-10DE5	8.1	●	10	49	61	103
DSW034-023-06DE5	3.4	●	6	23	28	66	DSW082-049-10DE5	8.2	●	10	49	61	103
DSW035-023-06DE5	3.5	●	6	23	28	66	DSW083-049-10DE5	8.3	●	10	49	61	103
DSW036-023-06DE5	3.6	●	6	23	28	66	DSW084-049-10DE5	8.4	●	10	49	61	103
DSW037-023-06DE5	3.7	●	6	23	28	66	DSW085-049-10DE5	8.5	●	10	49	61	103
DSW038-029-06DE5	3.8	●	6	29	36	74	DSW086-049-10DE5	8.6	●	10	49	61	103
DSW039-029-06DE5	3.9	●	6	29	36	74	DSW087-049-10DE5	8.7	●	10	49	61	103
DSW040-029-06DE5	4	●	6	29	36	74	DSW088-049-10DE5	8.8	●	10	49	61	103
DSW041-029-06DE5	4.1	●	6	29	36	74	DSW089-049-10DE5	8.9	●	10	49	61	103
DSW042-029-06DE5	4.2	●	6	29	36	74	DSW090-049-10DE5	9	●	10	49	61	103
DSW043-029-06DE5	4.3	●	6	29	36	74	DSW091-049-10DE5	9.1	●	10	49	61	103
DSW044-029-06DE5	4.4	●	6	29	36	74	DSW092-049-10DE5	9.2	●	10	49	61	103
DSW045-029-06DE5	4.5	●	6	29	36	74	DSW093-049-10DE5	9.3	●	10	49	61	103
DSW046-029-06DE5	4.6	●	6	29	36	74	DSW094-049-10DE5	9.4	●	10	49	61	103
DSW047-029-06DE5	4.7	●	6	29	36	74	DSW095-049-10DE5	9.5	●	10	49	61	103
DSW048-035-06DE5	4.8	●	6	35	44	82	DSW096-049-10DE5	9.6	●	10	49	61	103
DSW049-035-06DE5	4.9	●	6	35	44	82	DSW097-049-10DE5	9.7	●	10	49	61	103
DSW050-035-06DE5	5	●	6	35	44	82	DSW098-049-10DE5	9.8	●	10	49	61	103
DSW051-035-06DE5	5.1	●	6	35	44	82	DSW099-049-10DE5	9.9	●	10	49	61	103
DSW052-035-06DE5	5.2	●	6	35	44	82	DSW100-049-10DE5	10	●	10	49	61	103
DSW053-035-06DE5	5.3	●	6	35	44	82	DSW101-056-12DE5	10.1	●	12	56	71	118
DSW054-035-06DE5	5.4	●	6	35	44	82	DSW102-056-12DE5	10.2	●	12	56	71	118
DSW055-035-06DE5	5.5	●	6	35	44	82	DSW103-056-12DE5	10.3	●	12	56	71	118
DSW056-035-06DE5	5.6	●	6	35	44	82	DSW104-056-12DE5	10.4	●	12	56	71	118
DSW057-035-06DE5	5.7	●	6	35	44	82	DSW105-056-12DE5	10.5	●	12	56	71	118
DSW058-035-06DE5	5.8	●	6	35	44	82	DSW106-056-12DE5	10.6	●	12	56	71	118
DSW059-035-06DE5	5.9	●	6	35	44	82	DSW107-056-12DE5	10.7	●	12	56	71	118
DSW060-035-06DE5	6	●	6	35	44	82	DSW108-056-12DE5	10.8	●	12	56	71	118
DSW061-043-08DE5	6.1	●	8	43	53	91	DSW109-056-12DE5	10.9	●	12	56	71	118
DSW062-043-08DE5	6.2	●	8	43	53	91	DSW110-056-12DE5	11	●	12	56	71	118
DSW063-043-08DE5	6.3	●	8	43	53	91	DSW111-056-12DE5	11.1	●	12	56	71	118
DSW064-043-08DE5	6.4	●	8	43	53	91	DSW112-056-12DE5	11.2	●	12	56	71	118
DSW065-043-08DE5	6.5	●	8	43	53	91	DSW113-056-12DE5	11.3	●	12	56	71	118
DSW066-043-08DE5	6.6	●	8	43	53	91	DSW114-056-12DE5	11.4	●	12	56	71	118
DSW067-043-08DE5	6.7	●	8	43	53	91	DSW115-056-12DE5	11.5	●	12	56	71	118
DSW068-043-08DE5	6.8	●	8	43	53	91	DSW116-056-12DE5	11.6	●	12	56	71	118
DSW069-043-08DE5	6.9	●	8	43	53	91	DSW117-056-12DE5	11.7	●	12	56	71	118
DSW070-043-08DE5	7	●	8	43	53	91	DSW118-056-12DE5	11.8	●	12	56	71	118
DSW071-043-08DE5	7.1	●	8	43	53	91	DSW119-056-12DE5	11.9	●	12	56	71	118
DSW072-043-08DE5	7.2	●	8	43	53	91	DSW120-056-12DE5	12	●	12	56	71	118
DSW073-043-08DE5	7.3	●	8	43	53	91	DSW121-060-14DE5	12.1	●	14	60	77	124
DSW074-043-08DE5	7.4	●	8	43	53	91	DSW122-060-14DE5	12.2	●	14	60	77	124
DSW075-043-08DE5	7.5	●	8	43	53	91	DSW123-060-14DE5	12.3	●	14	60	77	124
DSW076-043-08DE5	7.6	●	8	43	53	91	DSW124-060-14DE5	12.4	●	14	60	77	124
DSW077-043-08DE5	7.7	●	8	43	53	91	DSW125-060-14DE5	12.5	●	14	60	77	124

● : Line up



Metric	ϕD_c	AH725	ϕD_s	ℓ_e	ℓ	L
DSW126-060-14DE5	12.6	●	14	60	77	124
DSW127-060-14DE5	12.7	●	14	60	77	124
DSW128-060-14DE5	12.8	●	14	60	77	124
DSW129-060-14DE5	12.9	●	14	60	77	124
DSW130-060-14DE5	13	●	14	60	77	124
DSW131-060-14DE5	13.1	●	14	60	77	124
DSW132-060-14DE5	13.2	●	14	60	77	124
DSW133-060-14DE5	13.3	●	14	60	77	124
DSW134-060-14DE5	13.4	●	14	60	77	124
DSW135-060-14DE5	13.5	●	14	60	77	124
DSW136-060-14DE5	13.6	●	14	60	77	124
DSW137-060-14DE5	13.7	●	14	60	77	124
DSW138-060-14DE5	13.8	●	14	60	77	124
DSW139-060-14DE5	13.9	●	14	60	77	124
DSW140-060-14DE5	14	●	14	60	77	124
DSW141-063-16DE5	14.1	●	16	63	83	133
DSW142-063-16DE5	14.2	●	16	63	83	133
DSW143-063-16DE5	14.3	●	16	63	83	133
DSW144-063-16DE5	14.4	●	16	63	83	133
DSW145-063-16DE5	14.5	●	16	63	83	133
DSW146-063-16DE5	14.6	●	16	63	83	133
DSW147-063-16DE5	14.7	●	16	63	83	133
DSW148-063-16DE5	14.8	●	16	63	83	133
DSW149-063-16DE5	14.9	●	16	63	83	133
DSW150-063-16DE5	15	●	16	63	83	133
DSW151-063-16DE5	15.1	●	16	63	83	133
DSW152-063-16DE5	15.2	●	16	63	83	133
DSW153-063-16DE5	15.3	●	16	63	83	133
DSW154-063-16DE5	15.4	●	16	63	83	133
DSW155-063-16DE5	15.5	●	16	63	83	133
DSW156-063-16DE5	15.6	●	16	63	83	133
DSW157-063-16DE5	15.7	●	16	63	83	133
DSW158-063-16DE5	15.8	●	16	63	83	133
DSW159-063-16DE5	15.9	●	16	63	83	133
DSW160-063-16DE5	16	●	16	63	83	133

● : Line up

Reference pages

Standard cutting conditions → E038



SOLIDDRILL

DSW-DI5

Solidrill with 140° point angle with oil hole & DIN shank, L/D = 5, dia = $\phi 3$ - $\phi 16$ mm

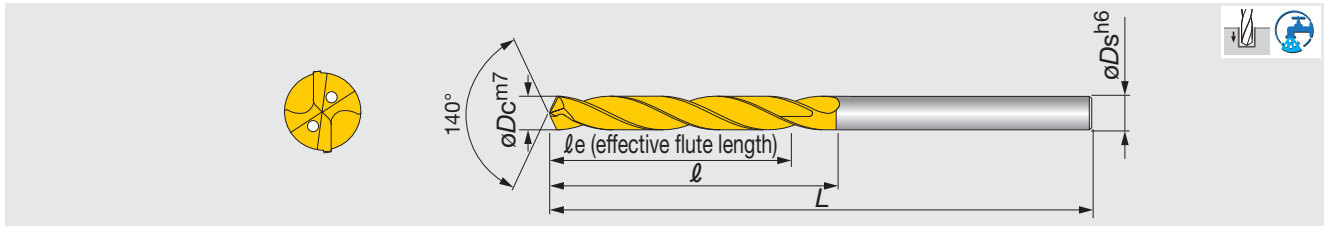

Metric	ϕD_c	AH725	ϕD_s	ℓ_e	ℓ	L	Metric	ϕD_c	AH725	ϕD_s	ℓ_e	ℓ	L
DSW030-023-06DI5	3	●	6	23	28	66	DSW078-043-08DI5	7.8	●	8	43	53	91
DSW031-023-06DI5	3.1	●	6	23	28	66	DSW079-043-08DI5	7.9	●	8	43	53	91
DSW032-023-06DI5	3.2	●	6	23	28	66	DSW080-043-08DI5	8	●	8	43	53	91
DSW033-023-06DI5	3.3	●	6	23	28	66	DSW081-049-10DI5	8.1	●	10	49	61	103
DSW034-023-06DI5	3.4	●	6	23	28	66	DSW082-049-10DI5	8.2	●	10	49	61	103
DSW035-023-06DI5	3.5	●	6	23	28	66	DSW083-049-10DI5	8.3	●	10	49	61	103
DSW036-023-06DI5	3.6	●	6	23	28	66	DSW084-049-10DI5	8.4	●	10	49	61	103
DSW037-023-06DI5	3.7	●	6	23	28	66	DSW085-049-10DI5	8.5	●	10	49	61	103
DSW038-029-06DI5	3.8	●	6	29	36	74	DSW086-049-10DI5	8.6	●	10	49	61	103
DSW039-029-06DI5	3.9	●	6	29	36	74	DSW087-049-10DI5	8.7	●	10	49	61	103
DSW040-029-06DI5	4	●	6	29	36	74	DSW088-049-10DI5	8.8	●	10	49	61	103
DSW041-029-06DI5	4.1	●	6	29	36	74	DSW089-049-10DI5	8.9	●	10	49	61	103
DSW042-029-06DI5	4.2	●	6	29	36	74	DSW090-049-10DI5	9	●	10	49	61	103
DSW043-029-06DI5	4.3	●	6	29	36	74	DSW091-049-10DI5	9.1	●	10	49	61	103
DSW044-029-06DI5	4.4	●	6	29	36	74	DSW092-049-10DI5	9.2	●	10	49	61	103
DSW045-029-06DI5	4.5	●	6	29	36	74	DSW093-049-10DI5	9.3	●	10	49	61	103
DSW046-029-06DI5	4.6	●	6	29	36	74	DSW094-049-10DI5	9.4	●	10	49	61	103
DSW047-029-06DI5	4.7	●	6	29	36	74	DSW095-049-10DI5	9.5	●	10	49	61	103
DSW048-035-06DI5	4.8	●	6	35	44	82	DSW096-049-10DI5	9.6	●	10	49	61	103
DSW049-035-06DI5	4.9	●	6	35	44	82	DSW097-049-10DI5	9.7	●	10	49	61	103
DSW050-035-06DI5	5	●	6	35	44	82	DSW098-049-10DI5	9.8	●	10	49	61	103
DSW051-035-06DI5	5.1	●	6	35	44	82	DSW099-049-10DI5	9.9	●	10	49	61	103
DSW052-035-06DI5	5.2	●	6	35	44	82	DSW100-049-10DI5	10	●	10	49	61	103
DSW053-035-06DI5	5.3	●	6	35	44	82	DSW101-056-12DI5	10.1	●	12	56	71	118
DSW054-035-06DI5	5.4	●	6	35	44	82	DSW102-056-12DI5	10.2	●	12	56	71	118
DSW055-035-06DI5	5.5	●	6	35	44	82	DSW103-056-12DI5	10.3	●	12	56	71	118
DSW056-035-06DI5	5.6	●	6	35	44	82	DSW104-056-12DI5	10.4	●	12	56	71	118
DSW057-035-06DI5	5.7	●	6	35	44	82	DSW105-056-12DI5	10.5	●	12	56	71	118
DSW058-035-06DI5	5.8	●	6	35	44	82	DSW106-056-12DI5	10.6	●	12	56	71	118
DSW059-035-06DI5	5.9	●	6	35	44	82	DSW107-056-12DI5	10.7	●	12	56	71	118
DSW060-035-06DI5	6	●	6	35	44	82	DSW108-056-12DI5	10.8	●	12	56	71	118
DSW061-043-08DI5	6.1	●	8	43	53	91	DSW109-056-12DI5	10.9	●	12	56	71	118
DSW062-043-08DI5	6.2	●	8	43	53	91	DSW110-056-12DI5	11	●	12	56	71	118
DSW063-043-08DI5	6.3	●	8	43	53	91	DSW111-056-12DI5	11.1	●	12	56	71	118
DSW064-043-08DI5	6.4	●	8	43	53	91	DSW112-056-12DI5	11.2	●	12	56	71	118
DSW065-043-08DI5	6.5	●	8	43	53	91	DSW113-056-12DI5	11.3	●	12	56	71	118
DSW066-043-08DI5	6.6	●	8	43	53	91	DSW114-056-12DI5	11.4	●	12	56	71	118
DSW067-043-08DI5	6.7	●	8	43	53	91	DSW115-056-12DI5	11.5	●	12	56	71	118
DSW068-043-08DI5	6.8	●	8	43	53	91	DSW116-056-12DI5	11.6	●	12	56	71	118
DSW069-043-08DI5	6.9	●	8	43	53	91	DSW117-056-12DI5	11.7	●	12	56	71	118
DSW070-043-08DI5	7	●	8	43	53	91	DSW118-056-12DI5	11.8	●	12	56	71	118
DSW071-043-08DI5	7.1	●	8	43	53	91	DSW119-056-12DI5	11.9	●	12	56	71	118
DSW072-043-08DI5	7.2	●	8	43	53	91	DSW120-056-12DI5	12	●	12	56	71	118
DSW073-043-08DI5	7.3	●	8	43	53	91	DSW121-060-14DI5	12.1	●	14	60	77	124
DSW074-043-08DI5	7.4	●	8	43	53	91	DSW122-060-14DI5	12.2	●	14	60	77	124
DSW075-043-08DI5	7.5	●	8	43	53	91	DSW123-060-14DI5	12.3	●	14	60	77	124
DSW076-043-08DI5	7.6	●	8	43	53	91	DSW124-060-14DI5	12.4	●	14	60	77	124
DSW077-043-08DI5	7.7	●	8	43	53	91	DSW125-060-14DI5	12.5	●	14	60	77	124

● : Line up



Metric	ϕD_c	AH725	ϕD_s	ℓ_e	ℓ	L
DSW126-060-14DI5	12.6	●	14	60	77	124
DSW127-060-14DI5	12.7	●	14	60	77	124
DSW128-060-14DI5	12.8	●	14	60	77	124
DSW129-060-14DI5	12.9	●	14	60	77	124
DSW130-060-14DI5	13	●	14	60	77	124
DSW131-060-14DI5	13.1	●	14	60	77	124
DSW132-060-14DI5	13.2	●	14	60	77	124
DSW133-060-14DI5	13.3	●	14	60	77	124
DSW134-060-14DI5	13.4	●	14	60	77	124
DSW135-060-14DI5	13.5	●	14	60	77	124
DSW136-060-14DI5	13.6	●	14	60	77	124
DSW137-060-14DI5	13.7	●	14	60	77	124
DSW138-060-14DI5	13.8	●	14	60	77	124
DSW139-060-14DI5	13.9	●	14	60	77	124
DSW140-060-14DI5	14	●	14	60	77	124
DSW141-063-16DI5	14.1	●	16	63	83	133
DSW142-063-16DI5	14.2	●	16	63	83	133
DSW143-063-16DI5	14.3	●	16	63	83	133
DSW144-063-16DI5	14.4	●	16	63	83	133
DSW145-063-16DI5	14.5	●	16	63	83	133
DSW146-063-16DI5	14.6	●	16	63	83	133
DSW147-063-16DI5	14.7	●	16	63	83	133
DSW148-063-16DI5	14.8	●	16	63	83	133
DSW149-063-16DI5	14.9	●	16	63	83	133
DSW150-063-16DI5	15	●	16	63	83	133
DSW151-063-16DI5	15.1	●	16	63	83	133
DSW152-063-16DI5	15.2	●	16	63	83	133
DSW153-063-16DI5	15.3	●	16	63	83	133
DSW154-063-16DI5	15.4	●	16	63	83	133
DSW155-063-16DI5	15.5	●	16	63	83	133
DSW156-063-16DI5	15.6	●	16	63	83	133
DSW157-063-16DI5	15.7	●	16	63	83	133
DSW158-063-16DI5	15.8	●	16	63	83	133
DSW159-063-16DI5	15.9	●	16	63	83	133
DSW160-063-16DI5	16	●	16	63	83	133

● : Line up

Reference pages

Standard cutting conditions → E038



SOLIDDRILL

DSW-DI8

Solidrill with 140° point angle with oil hole & DIN shank, L/D = 8, dia = ø3 - ø10 mm

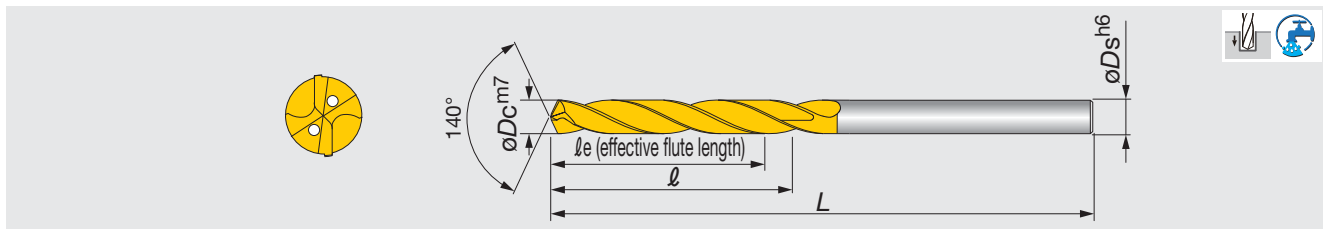

Metric	øDc	AH725	øDs	le	l	L
DSW030-029-06DI8	3	●	6	29	34	72
DSW031-029-06DI8	3.1	●	6	29	34	72
DSW032-029-06DI8	3.2	●	6	29	34	72
DSW033-029-06DI8	3.3	●	6	29	34	72
DSW034-029-06DI8	3.4	●	6	29	34	72
DSW035-029-06DI8	3.5	●	6	29	34	72
DSW036-029-06DI8	3.6	●	6	29	34	72
DSW037-029-06DI8	3.7	●	6	29	34	72
DSW038-036-06DI8	3.8	●	6	36	43	81
DSW039-036-06DI8	3.9	●	6	36	43	81
DSW040-036-06DI8	4	●	6	36	43	81
DSW041-036-06DI8	4.1	●	6	36	43	81
DSW042-036-06DI8	4.2	●	6	36	43	81
DSW043-036-06DI8	4.3	●	6	36	43	81
DSW044-036-06DI8	4.4	●	6	36	43	81
DSW045-036-06DI8	4.5	●	6	36	43	81
DSW046-036-06DI8	4.6	●	6	36	43	81
DSW047-036-06DI8	4.7	●	6	36	43	81
DSW048-048-06DI8	4.8	●	6	48	57	95
DSW049-048-06DI8	4.9	●	6	48	57	95
DSW050-048-06DI8	5	●	6	48	57	95
DSW051-048-06DI8	5.1	●	6	48	57	95
DSW052-048-06DI8	5.2	●	6	48	57	95
DSW053-048-06DI8	5.3	●	6	48	57	95
DSW054-048-06DI8	5.4	●	6	48	57	95
DSW055-048-06DI8	5.5	●	6	48	57	95
DSW056-048-06DI8	5.6	●	6	48	57	95
DSW057-048-06DI8	5.7	●	6	48	57	95
DSW058-048-06DI8	5.8	●	6	48	57	95
DSW059-048-06DI8	5.9	●	6	48	57	95
DSW060-048-06DI8	6	●	6	48	57	95
DSW061-064-08DI8	6.1	●	8	64	76	114
DSW062-064-08DI8	6.2	●	8	64	76	114
DSW063-064-08DI8	6.3	●	8	64	76	114
DSW064-064-08DI8	6.4	●	8	64	76	114
DSW065-064-08DI8	6.5	●	8	64	76	114
DSW066-064-08DI8	6.6	●	8	64	76	114
DSW067-064-08DI8	6.7	●	8	64	76	114
DSW068-064-08DI8	6.8	●	8	64	76	114
DSW069-064-08DI8	6.9	●	8	64	76	114
DSW070-064-08DI8	7	●	8	64	76	114
DSW071-064-08DI8	7.1	●	8	64	76	114
DSW072-064-08DI8	7.2	●	8	64	76	114
DSW073-064-08DI8	7.3	●	8	64	76	114
DSW074-064-08DI8	7.4	●	8	64	76	114

Metric	øDc	AH725	øDs	le	l	L
DSW075-064-08DI8	7.5	●	8	64	76	114
DSW076-064-08DI8	7.6	●	8	64	76	114
DSW077-064-08DI8	7.7	●	8	64	76	114
DSW078-064-08DI8	7.8	●	8	64	76	114
DSW079-064-08DI8	7.9	●	8	64	76	114
DSW080-064-08DI8	8	●	8	64	76	114
DSW081-080-10DI8	8.1	●	10	80	95	142
DSW082-080-10DI8	8.2	●	10	80	95	142
DSW083-080-10DI8	8.3	●	10	80	95	142
DSW084-080-10DI8	8.4	●	10	80	95	142
DSW085-080-10DI8	8.5	●	10	80	95	142
DSW086-080-10DI8	8.6	●	10	80	95	142
DSW087-080-10DI8	8.7	●	10	80	95	142
DSW088-080-10DI8	8.8	●	10	80	95	142
DSW089-080-10DI8	8.9	●	10	80	95	142
DSW090-080-10DI8	9	●	10	80	95	142
DSW091-080-10DI8	9.1	●	10	80	95	142
DSW092-080-10DI8	9.2	●	10	80	95	142
DSW093-080-10DI8	9.3	●	10	80	95	142
DSW094-080-10DI8	9.4	●	10	80	95	142
DSW095-080-10DI8	9.5	●	10	80	95	142
DSW096-080-10DI8	9.6	●	10	80	95	142
DSW097-080-10DI8	9.7	●	10	80	95	142
DSW098-080-10DI8	9.8	●	10	80	95	142
DSW099-080-10DI8	9.9	●	10	80	95	142
DSW100-080-10DI8	10	●	10	80	95	142

Reference pages

Standard cutting conditions → E038

● : Line up



Recommended coolant pressure and volume for internal coolant supply:

The following graph is a reference guide for pressure and volume. Values should be adjusted according to work material and actual chip evacuation.

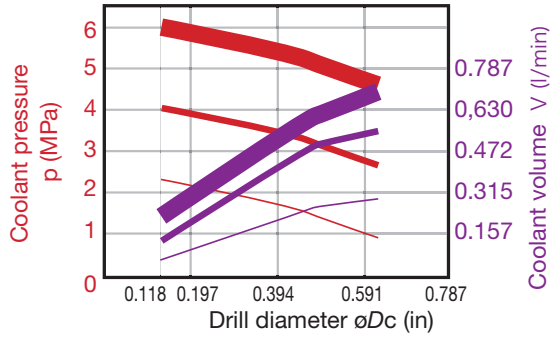

- █ : Ideal pressure
- █ : Enough pressure
- █ : Minimum pressure
- █ : Ideal volume
- █ : Enough volume
- █ : Minimum volume

Reference for required spindle power:

The required spindle power may vary depending on the type of work material or hardness. A spindle with sufficient power should be used when referring to the below graph.

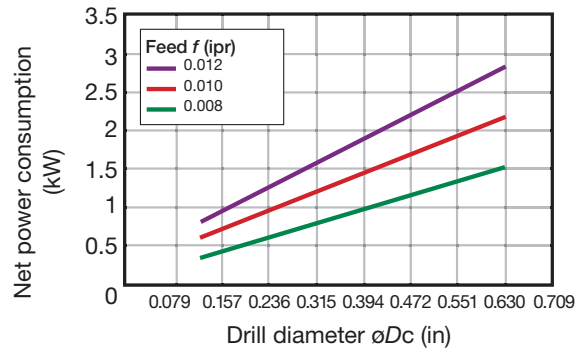

Work material : Alloy steel (SNCM439)
Cutting speed : $V_c = 328$ sfm

Designation system

DSW 088 - 035 - 10 - D E 3

1 Series
DSW Series name of solid drill

2 Drill dia. øDc (mm)
088 ø8.8

3 Effective flute length l_e (mm)
035 35

4 Shank diameter øDs (mm)
10 ø10

5 DIN 6535 - Form HA

6 Coolant Supply
E External (without coolant hole)
I Internal (with coolant hole)

7 Drilling depth
Approximate value of L/D ratio.
Caution: Code may be different from the actual length. This is dependent upon the tool diameter.

Caution: "Effective flute length" shows the maximum flute length for effective chip evacuation. The actual drilling depth may be shorter than described depending on the work material or cutting conditions.



STANDARD CUTTING CONDITIONS

DSW-DE (External supply)

ISO	Workpiece material	Brinell hardness (HB)	Cutting speed: Vc (sfm)			Feed: f (ipr)		
			ø0.118 - ø0.236	ø0.236 - ø0.394	ø0.394 - ø0.630	ø0.118 - ø0.236	ø0.236 - ø0.394	ø0.394 - ø0.630
P	Low carbon steels (C < 0.3) 1018, 1020, 1026, etc.	~ 180	131 - 328	197 - 394	197 - 427	0.006 - 0.012	0.006 - 0.014	0.008 - 0.020
	Carbon steels (C > 0.3) 1045, 1055, etc.	180 ~ 300	131 - 295	164 - 394	197 - 427	0.006 - 0.012	0.006 - 0.014	0.008 - 0.016
	High alloy steels 4140, 8620, etc.	250 ~ 350	131 - 262	164 - 328	164 - 328	0.004 - 0.008	0.006 - 0.012	0.006 - 0.014
M	Stainless steels 304SS, 316SS, 17-4 PH, etc.	~ 200	66 - 131	98 - 164	98 - 197	0.002 - 0.008	0.004 - 0.010	0.004 - 0.012
K	Gray cast irons Class 25, Class 30, etc.	~ 200	131 - 295	164 - 312	164 - 328	0.006 - 0.012	0.008 - 0.016	0.008 - 0.020
	Ductile cast irons 65-40-18, 60-55-06, etc.	~ 300	98 - 262	131 - 295	148 - 295	0.004 - 0.012	0.008 - 0.016	0.008 - 0.016
N	Aluminum alloys 6061, 7075, etc.	-	131 - 295	164 - 328	164 - 328	0.006 - 0.012	0.008 - 0.016	0.008 - 0.020
S	Titanium alloys Ti-6Al-4V, etc.	-	66 - 131	66 - 131	66 - 131	0.004 - 0.008	0.006 - 0.010	0.006 - 0.016
	Heat-resistant alloys, Inconel Inconel 718, etc.	250 ~	33 - 98	33 - 98	33 - 98	0.001 - 0.003	0.002 - 0.004	0.003 - 0.005
H	Hardened material	~ 40HRC	66 - 131	66 - 131	66 - 131	0.002 - 0.006	0.002 - 0.006	0.002 - 0.008

- The cutting parameters shown in the table are merely a starting guideline for general machining. Values should be varied depending on the power or rigidity of the machine to be used. Optimum conditions should be selected depending on the actual chip control or damage on edges.
- When using the smaller diameter tools in each range, set the feed "f" to the lower recommended values.

- The coolant supply is critical for the provision of stable machining conditions and enhanced tool life. A large coolant volume should be supplied, especially when drilling difficult-to-cut materials.
- When drilling stainless steel with low machinability such as austenitic stainless steel with a depth deeper than L/D = 3, a pecking cycle or internal coolant supply is recommended.

DSW-DI (Internal supply)

ISO	Workpiece material	Brinell hardness (HB)	Cutting speed: Vc (sfm)			Feed: f (ipr)		
			ø0.118 - ø0.236	ø0.236 - ø0.394	ø0.394 - ø0.630	ø0.118 - ø0.236	ø0.236 - ø0.394	ø0.394 - ø0.630
P	Low carbon steels (C < 0.3) 1018, 1020, 1026, etc.	~ 180	230 - 459	262 - 525	295 - 623	0.006 - 0.012	0.006 - 0.014	0.008 - 0.020
	Carbon steels (C > 0.3) 1045, 1055, etc.	180 ~ 300	164 - 427	230 - 525	262 - 558	0.006 - 0.012	0.006 - 0.014	0.008 - 0.016
	High alloy steels 4140, 8620, etc.	250 ~ 350	131 - 328	197 - 459	197 - 525	0.004 - 0.008	0.006 - 0.012	0.006 - 0.014
M	Stainless steels 304SS, 316SS, 17-4 PH, etc.	~ 200	82 - 246	164 - 328	164 - 394	0.002 - 0.008	0.004 - 0.010	0.004 - 0.012
K	Gray cast irons Class 25, Class 30, etc.	~ 200	262 - 459	328 - 525	328 - 591	0.006 - 0.012	0.008 - 0.016	0.008 - 0.020
	Ductile cast irons 65-40-18, 60-55-06, etc.	~ 300	230 - 459	262 - 492	262 - 558	0.004 - 0.012	0.008 - 0.016	0.008 - 0.018
N	Aluminum alloys 6061, 7075, etc.	-	197 - 656	197 - 656	197 - 656	0.006 - 0.012	0.008 - 0.016	0.008 - 0.020
S	Titanium alloys Ti-6Al-4V, etc.	-	66 - 197	98 - 262	98 - 262	0.004 - 0.008	0.004 - 0.010	0.006 - 0.016
	Heat-resistant alloys, Inconel Inconel 718, etc.	250 ~	33 - 98	33 - 131	33 - 131	0.001 - 0.003	0.002 - 0.004	0.003 - 0.006
H	Hardened material	~ 40HRC	66 - 164	98 - 197	98 - 197	0.002 - 0.006	0.002 - 0.006	0.002 - 0.008

- The cutting parameters shown in the table are merely a starting guideline for general machining. Values should be varied depending on the power or rigidity of the machine to be used. Optimum conditions should be selected depending on the actual chip control or damage on edges.

- When using the smaller diameter tools in each range, set the feed "f" to the lower recommended values.
- Oil holes that become blocked may cause drill breakages. A filter to prevent the circulation of chips must be used on the coolant supply system.

Guidelines for correct usage of carbide drills

● Holders for solid carbide drills:

A collet chuck holder is recommended for use with carbide drills. When using a milling chuck holder, a collet chuck with a straight shank or straight collet should be used.

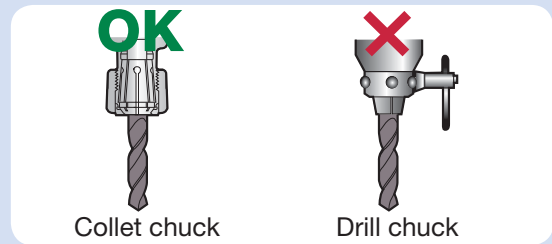

● Chucking drills:

- Radial run out and lip height should be less than 0.0008" (0.02mm). If run out or lip height is larger (close to 0.002" (0.05mm)), machining is possible. However, less accurate holes or short tool life may be a result.
- Overhang length should be as short as possible.

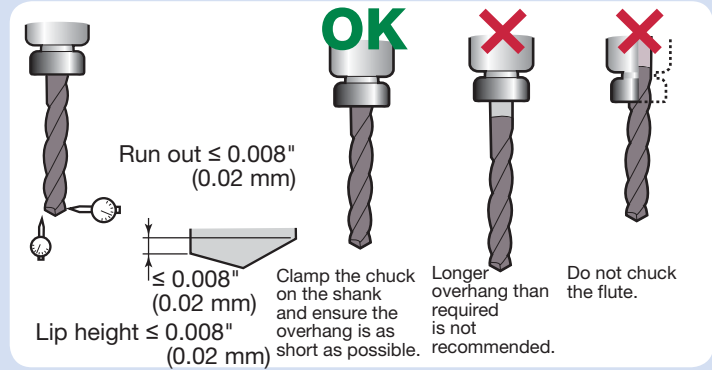

● Coolant Supply:

When using a drill without a coolant hole, such as the DSW-DE type, coolant should always be directed to the entrance of the hole. Maintaining this supplying is very important for stable drilling performance.

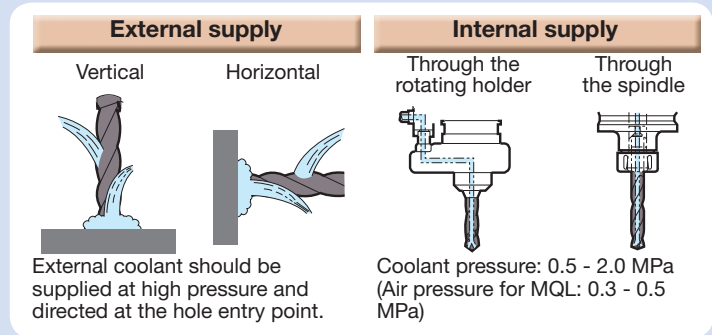

● Clamping workpieces:

As solid carbide drills have a higher thrust force, machining with low rigidity or inadequate support can cause fractures or breakages through vibration. It is important the workpiece is rigidly clamped and has adequate support.

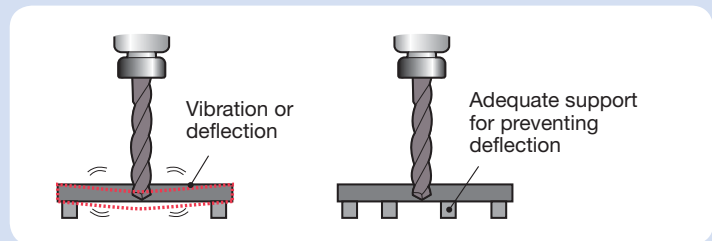

● The criteria of tool life:

- Corner wear width: equal to margin width
- Feed mark: 1 - 2 feed marks on the margin
- Spindle load increase: 30% higher than starting level
- Irregular situation: worse chip control, hole diameter change, worse surface finish, larger burrs, bigger sound.

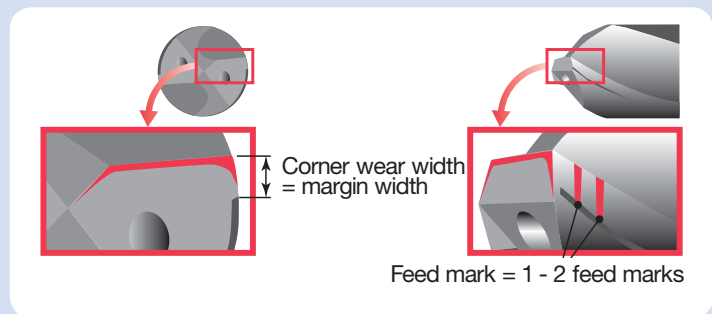

Regrinding Procedures

Regrinding method [Applied to DSW]

Before regrinding

Check the cutting edge for damage and wear. If any large fracture is found, remove with a silicon carbide wheel.

(1) Grinding the flank

- Use a 280 to 400 grit diamond cup type wheel of 3.937" ~ 7.874" in diameter.
- 1) Grind the relief surface so that primary relief angle (θ) of 2° can be formed as shown in Fig.1. After grinding the other side likewise, do sparkout grinding so that the difference of the lip height will be kept within 0.001".
- 2) In the cases of DSW types: After grinding the primary relief angle (θ) 2°, without rotating the drill, grind the secondary relief surface so that the relief angle (θ) of 3° can be formed. In the same way as 2), take care to bring the ridge line formed between the primary and secondary relief surfaces to the drill center. (Values (θ) of 1° ~ 3° are shown in Table 1)

● Fig. 1 Grinding relief angle

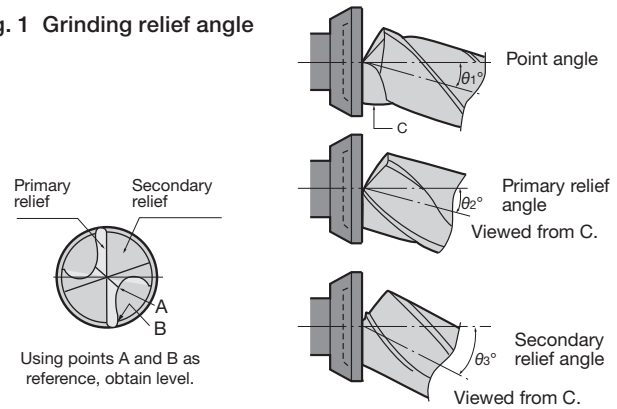

(2) Thinning

- Use a 280 ~ 400 grit diamond straight-type wheel of 3.937" ~ 7.874" in diameter.
- Conduct thinning in the same manner as cross thinning (X-type).
- Values of β_1 to β_3 written in the figures are given in the Table 2.

Table 1	θ_1 (Point angle)	θ_2 (Primary relief angle)	θ_3 (Secondary relief angle)
DSW	-20°	-6° ~ -12°	-23° ~ -27°

Table 2	β_1	β_2	β_3
DSW	147° ~ 153°	30° ~ 42°	95° ~ 110°

● Fig. 2

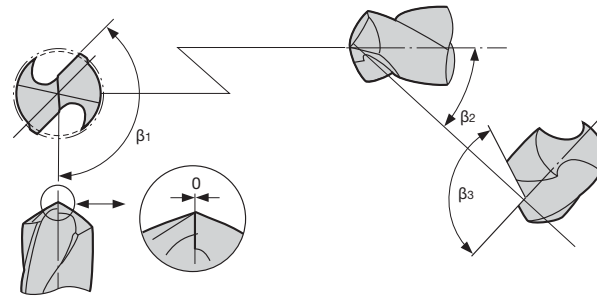

(3) Honing

- The honing angle θ and width H should be varied depending on the drill type, diameter, and work material. Recommended honing specifications are given in the Table below.
- Honing procedures (refer to Fig.3)
 - (1) Round the R portion shown in Fig.3 in large.
 - (2) Then, roughly hone the cutting edge lines by using an electro-deposited diamond file of around 170 grit.
 - (3) Carry out finish honing by using a diamond hand stick of 400 to 600 grit.
- The honing width should be changed depending on the drill diameter. For smaller side of diameters, the width should be in smaller side of values given in the Table.

● Angle honing

	~ $\phi 0.236$ " (~ $\phi 6$ mm)	$\phi 0.236$ " ~ $\phi 0.394$ " ($\phi 6$ ~ $\phi 10$ mm)	$\phi 0.394$ " ~ $\phi 0.630$ " ($\phi 10$ ~ $\phi 16$ mm)
θ	- 20°	- 20°	- 20°
H	0.001 ~ 0.002	0.002 ~ 0.003	0.003 ~ 0.004

● R Honing

Dimensions (in)	R Honing R (in)
$\phi D_c \leq \phi 0.236$	0.0078 ~ 0.0015
$\phi 0.236 < \phi D_c \leq \phi 0.630$	0.0011 ~ 0.0019

● Fig. 3

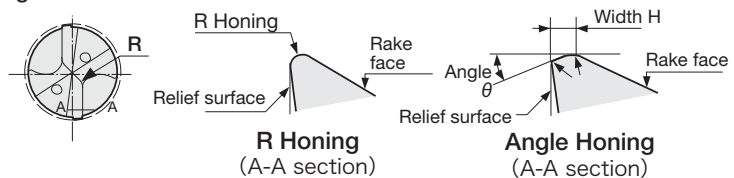

After regrinding, check the following before use.

- The difference of the lip height is kept within 0.0007".
- Any damaged portion on the cutting edges is not left.
- Cutting edges are properly honed.
- Any grinding burr is not left.

Notes:

- For more details on regrinding, consult the nearest Tungaloy sales office.

MEMO

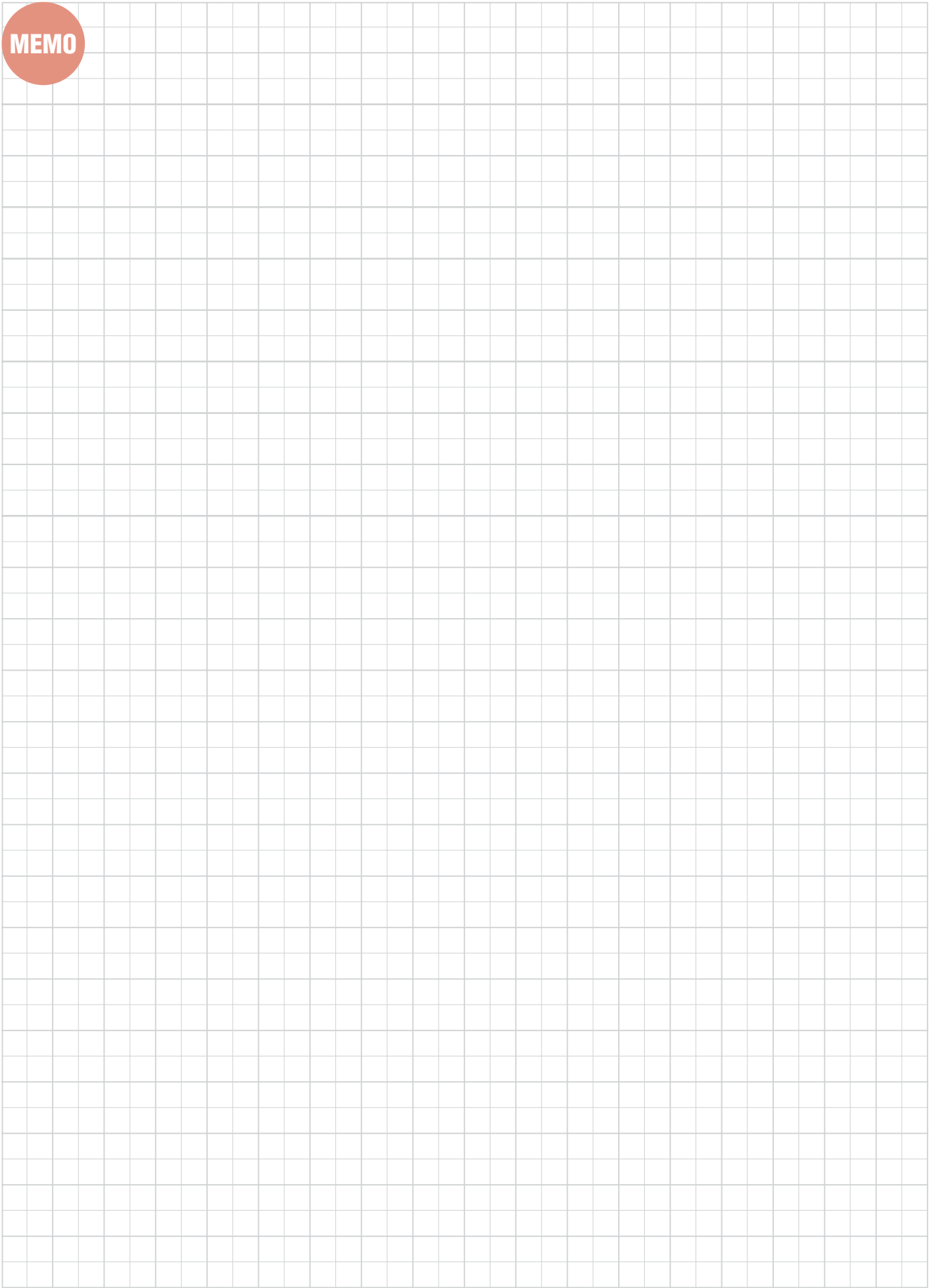



GIGAJETDRILL

DSXU-F03, 05, 08

Solid drill with 140° point angle with oil hole & shank size equal to drill dia., L/D = 3, 5, 8, dia = ø0.125" - ø0.781"

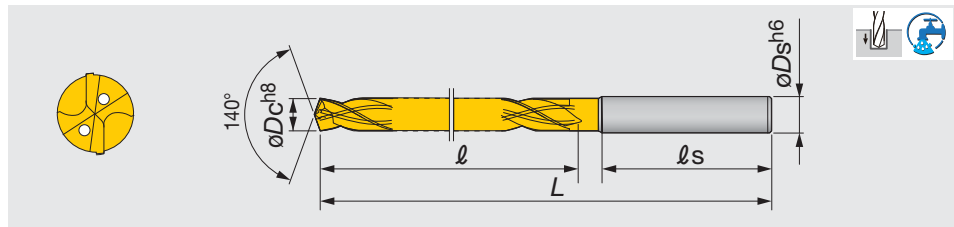

L/D = 3

Inch	øDc	AH180	øDs	ℓ	ℓs	L
*DSXU1250F03	1/8	●	0.156	0.709	1.89	2.80
*DSXU1406F03	9/64	●	0.156	0.787	1.89	2.87
*DSXU1562F03	5/32	●	0.156	0.787	1.89	2.87
DSXU1719F03	11/64	●	0.188	0.906	1.97	3.07
DSXU1875F03	3/16	●	0.188	0.984	1.97	3.15
DSXU2031F03	13/64	●	0.203	1.10	2.05	3.23
DSXU2188F03	7/32	●	0.219	1.18	2.05	3.23
DSXU2344F03	#A15/64	●	0.234	1.18	2.05	3.23
DSXU2500F03	#E1/4	●	0.250	1.30	2.09	3.39
DSXU2656F03	17/64	●	0.266	1.38	2.09	3.46
DSXU2813F03	9/32	●	0.281	1.50	2.13	3.62
DSXU2969F03	19/64	●	0.297	1.57	2.13	3.70
DSXU3125F03	5/16	●	0.313	1.57	2.13	3.70
DSXU3281F03	21/64	●	0.328	1.69	2.17	3.94
DSXU3438F03	11/32	●	0.344	1.77	2.17	3.94
DSXU3594F03	23/64	●	0.359	1.89	2.20	4.17
DSXU3750F03	3/8	●	0.375	1.97	2.20	4.17
DSXU3906F03	25/64	●	0.391	1.97	2.20	4.17
DSXU4063F03	13/32	●	0.406	2.09	2.40	4.57
DSXU4219F03	27/64	●	0.422	2.17	2.40	4.57
DSXU4375F03	7/16	●	0.438	2.28	2.44	4.80
DSXU4531F03	29/64	●	0.453	2.36	2.44	4.80
DSXU4688F03	15/32	●	0.469	2.36	2.44	4.80
DSXU4844F03	31/64	●	0.484	2.56	2.48	5.04
DSXU5000F03	1/2	●	0.500	2.56	2.48	5.04
DSXU5156F03	33/64	●	0.516	2.76	2.52	5.28
DSXU5313F03	17/32	●	0.531	2.76	2.52	5.28
DSXU5469F03	35/64	●	0.547	2.76	2.52	5.28
DSXU5625F03	9/16	●	0.563	2.95	2.56	5.51
DSXU5781F03	37/64	●	0.578	2.95	2.56	5.51
DSXU5938F03	19/32	●	0.594	3.15	2.60	5.75
DSXU6094F03	39/64	●	0.609	3.15	2.60	5.75
DSXU6250F03	5/8	●	0.625	3.15	2.60	5.75
DSXU6406F03	41/64	●	0.641	3.35	2.64	5.98
DSXU6562F03	21/32	●	0.656	3.35	2.64	5.98
DSXU6875F03	11/16	●	0.688	3.54	2.68	6.22
DSXU7031F03	45/64	●	0.703	3.54	2.68	6.22
DSXU7187F03	23/32	●	0.719	3.74	2.72	6.46
DSXU7344F03	47/64	●	0.734	3.74	2.72	6.46
DSXU7500F03	3/4	●	0.750	3.94	2.76	6.69
DSXU7656F03	49/64	●	0.766	3.94	2.76	6.69
DSXU7812F03	25/32	●	0.781	3.94	2.76	6.69

L/D = 5

Inch	øDc	AH180	øDs	ℓ	ℓs	L
DSXU1250F05	1/8	●	0.156	1.10	1.89	3.19
DSXU1406F05	9/64	●	0.156	1.26	1.89	3.35
DSXU1562F05	5/32	●	0.156	1.26	1.89	3.35
DSXU1719F05	11/64	●	0.188	1.42	1.97	3.58
DSXU1875F05	3/16	●	0.188	1.57	1.97	3.70
DSXU2031F05	13/64	●	0.203	1.73	2.05	3.78
DSXU2188F05	7/32	●	0.219	1.89	2.05	3.94
DSXU2344F05	#A15/64	●	0.234	1.89	2.05	3.94
DSXU2500F05	#E1/4	●	0.250	2.05	2.09	4.13
DSXU2656F05	17/64	●	0.266	2.20	2.09	4.29
DSXU2813F05	9/32	●	0.281	2.36	2.13	4.49
DSXU2969F05	19/64	●	0.297	2.52	2.13	4.65
DSXU3125F05	5/16	●	0.313	2.52	2.13	4.65
DSXU3281F05	21/64	●	0.328	2.68	2.17	5.00
DSXU3438F05	11/32	●	0.344	2.83	2.17	5.00
DSXU3594F05	23/64	●	0.359	2.99	2.20	5.35
DSXU3750F05	3/8	●	0.375	3.15	2.20	5.35
DSXU3906F05	25/64	●	0.391	3.15	2.20	5.35
DSXU4063F05	13/32	●	0.406	3.31	2.40	5.87
DSXU4219F05	27/64	●	0.422	3.46	2.40	5.87
DSXU4375F05	7/16	●	0.438	3.62	2.44	6.22
DSXU4531F05	29/64	●	0.453	3.78	2.44	6.22
DSXU4688F05	15/32	●	0.469	3.78	2.44	6.22
DSXU4844F05	31/64	●	0.484	4.09	2.48	6.57
DSXU5000F05	1/2	●	0.500	4.09	2.48	6.57
DSXU5156F05	33/64	●	0.516	4.41	2.52	6.93
DSXU5313F05	17/32	●	0.531	4.41	2.52	6.93
DSXU5469F05	35/64	●	0.547	4.41	2.52	6.93
DSXU5625F05	9/16	●	0.563	4.72	2.56	7.28
DSXU5781F05	37/64	●	0.578	4.72	2.56	7.28
DSXU5938F05	19/32	●	0.594	5.04	2.60	7.64
DSXU6094F05	39/64	●	0.609	5.04	2.60	7.64
DSXU6250F05	5/8	●	0.625	5.04	2.60	7.64
DSXU6406F05	41/64	●	0.641	5.35	2.64	7.99
DSXU6562F05	21/32	●	0.656	5.35	2.64	7.99
DSXU6875F05	11/16	●	0.688	5.67	2.68	8.35
DSXU7031F05	45/64	●	0.703	5.67	2.68	8.35
DSXU7187F05	23/32	●	0.719	5.98	2.72	8.70
DSXU7344F05	47/64	●	0.734	5.98	2.72	8.70
DSXU7500F05	3/4	●	0.750	6.30	2.76	9.06
DSXU7656F05	49/64	●	0.766	6.30	2.76	9.06
DSXU7812F05	25/32	●	0.781	6.30	2.76	9.06

Note: L/D = Hole depth / Drill diameter
*Shank size is not equal to drill diameter.

● : Line up



■ L/D = 8

Inch	ϕD_c	AH180	ϕD_s	ℓ	ℓ_s	L
DSXU1250F08	1/8	●	0.156	1.54	1.89	3.62
DSXU1406F08	9/64	●	0.156	1.73	1.89	3.82
DSXU1562F08	5/32	●	0.156	1.73	1.89	3.82
DSXU1719F08	11/64	●	0.188	1.97	1.97	4.13
DSXU1875F08	3/16	●	0.188	2.17	1.97	4.33
DSXU2031F08	13/64	●	0.203	2.40	2.05	4.45
DSXU2188F08	7/32	●	0.219	2.60	2.05	4.65
DSXU2344F08	#A15/64	●	0.234	2.60	2.05	4.65
DSXU2500F08	#E1/4	●	0.250	2.83	2.09	4.92
DSXU2656F08	17/64	●	0.266	3.03	2.09	5.12
DSXU2813F08	9/32	●	0.281	3.27	2.13	5.39
DSXU2969F08	19/64	●	0.297	3.46	2.13	5.59
DSXU3125F08	5/16	●	0.313	3.46	2.13	5.59
DSXU3281F08	21/64	●	0.328	3.70	2.17	6.06
DSXU3438F08	11/32	●	0.344	3.90	2.17	6.06
DSXU3594F08	23/64	●	0.359	4.11	2.20	6.54
DSXU3750F08	3/8	●	0.375	4.33	2.20	6.54
DSXU3906F08	25/64	●	0.391	4.33	2.20	6.54
DSXU4063F08	13/32	●	0.406	4.57	2.40	7.17
DSXU4219F08	27/64	●	0.422	4.76	2.40	7.17
DSXU4375F08	7/16	●	0.438	5.00	2.44	7.64
DSXU4531F08	29/64	●	0.453	5.20	2.44	7.64
DSXU4688F08	15/32	●	0.469	5.20	2.44	7.64
DSXU4844F08	31/64	●	0.484	5.63	2.48	8.11
DSXU5000F08	1/2	●	0.500	5.63	2.48	8.11
DSXU5156F08	33/64	●	0.516	6.06	2.52	8.58
DSXU5313F08	17/32	●	0.531	6.06	2.52	8.58
DSXU5469F08	35/64	●	0.547	6.06	2.52	8.58
DSXU5625F08	9/16	●	0.563	6.50	2.56	9.06
DSXU5781F08	37/64	●	0.578	6.50	2.56	9.06
DSXU5938F08	19/32	●	0.594	6.93	2.60	9.53
DSXU6094F08	39/64	●	0.609	6.93	2.60	9.53
DSXU6250F08	5/8	●	0.625	6.93	2.60	9.53

Note: L/D = Hole depth / Drill diameter

● : Line up

• No. of revolutions (min^{-1}) = Cutting speed \times 1000 \div 3.14 \div Tool diameter• Table feed (mm/min) = No. of revolutions \times Feed per revolution

Most unmarked items are available on a RFQ basis, contact your sales rep for more information.

Reference pages

Standard cutting conditions \rightarrow E049



2-effective Drill

GIGA JET DRILL

DSX-F03

Soliddrill with 140° point angle with oil hole, L/D = 3, dia = ø3 - ø20 mm

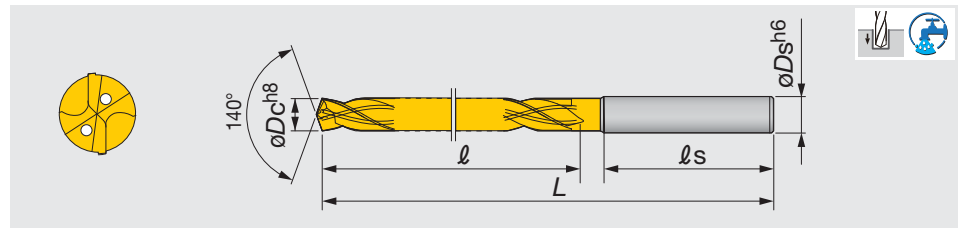

Metric	$\varnothing D_c$	AH180	$\varnothing D_s$	ℓ	ℓ_s	L	Metric	$\varnothing D_c$	AH180	$\varnothing D_s$	ℓ	ℓ_s	L
DSX0300F03	3	●	3	15	48	68	DSX0880F03	8.8	●	9	45	55	100
DSX0310F03	3.1	●	4	18	48	71	DSX0890F03	8.9	●	9	45	55	100
DSX0320F03	3.2	●	4	18	48	71	DSX0900F03	9	●	9	45	55	100
DSX0330F03	3.3	●	4	18	48	71	DSX0910F03	9.1	●	10	48	56	106
DSX0340F03	3.4	●	4	18	48	71	DSX0920F03	9.2	●	10	48	56	106
DSX0350F03	3.5	●	4	18	48	71	DSX0930F03	9.3	●	10	48	56	106
DSX0360F03	3.6	●	4	20	48	73	DSX0940F03	9.4	●	10	48	56	106
DSX0370F03	3.7	●	4	20	48	73	DSX0950F03	9.5	●	10	48	56	106
DSX0380F03	3.8	●	4	20	48	73	DSX0960F03	9.6	●	10	50	56	106
DSX0390F03	3.9	●	4	20	48	73	DSX0970F03	9.7	●	10	50	56	106
DSX0400F03	4	●	4	20	48	73	DSX0980F03	9.8	●	10	50	56	106
DSX0410F03	4.1	●	5	23	50	78	DSX0990F03	9.9	●	10	50	56	106
DSX0420F03	4.2	●	5	23	50	78	DSX1000F03	10	●	10	50	56	106
DSX0430F03	4.3	●	5	23	50	78	DSX1010F03	10.1	●	11	53	61	116
DSX0440F03	4.4	●	5	23	50	78	DSX1020F03	10.2	●	11	53	61	116
DSX0450F03	4.5	●	5	23	50	78	DSX1030F03	10.3	●	11	53	61	116
DSX0460F03	4.6	●	5	25	50	80	DSX1040F03	10.4	●	11	53	61	116
DSX0470F03	4.7	●	5	25	50	80	DSX1050F03	10.5	●	11	53	61	116
DSX0480F03	4.8	●	5	25	50	80	DSX1060F03	10.6	●	11	55	61	116
DSX0490F03	4.9	●	5	25	50	80	DSX1070F03	10.7	●	11	55	61	116
DSX0500F03	5	●	5	25	50	80	DSX1080F03	10.8	●	11	55	61	116
DSX0510F03	5.1	●	6	28	52	82	DSX1090F03	10.9	●	11	55	61	116
DSX0520F03	5.2	●	6	28	52	82	DSX1100F03	11	●	11	55	61	116
DSX0530F03	5.3	●	6	28	52	82	DSX1110F03	11.1	●	12	58	62	122
DSX0540F03	5.4	●	6	28	52	82	DSX1120F03	11.2	●	12	58	62	122
DSX0550F03	5.5	●	6	28	52	82	DSX1130F03	11.3	●	12	58	62	122
DSX0560F03	5.6	●	6	30	52	82	DSX1140F03	11.4	●	12	58	62	122
DSX0570F03	5.7	●	6	30	52	82	DSX1150F03	11.5	●	12	58	62	122
DSX0580F03	5.8	●	6	30	52	82	DSX1160F03	11.6	●	12	60	62	122
DSX0590F03	5.9	●	6	30	52	82	DSX1170F03	11.7	●	12	60	62	122
DSX0600F03	6	●	6	30	52	82	DSX1180F03	11.8	●	12	60	62	122
DSX0610F03	6.1	●	7	33	53	86	DSX1190F03	11.9	●	12	60	62	122
DSX0620F03	6.2	●	7	33	53	86	DSX1200F03	12	●	12	60	62	122
DSX0630F03	6.3	●	7	33	53	86	DSX1210F03	12.1	●	13	65	63	128
DSX0640F03	6.4	●	7	33	53	86	DSX1220F03	12.2	●	13	65	63	128
DSX0650F03	6.5	●	7	33	53	86	DSX1230F03	12.3	●	13	65	63	128
DSX0660F03	6.6	●	7	35	53	88	DSX1240F03	12.4	●	13	65	63	128
DSX0670F03	6.7	●	7	35	53	88	DSX1250F03	12.5	●	13	65	63	128
DSX0680F03	6.8	●	7	35	53	88	DSX1260F03	12.6	●	13	65	63	128
DSX0690F03	6.9	●	7	35	53	88	DSX1270F03	12.7	●	13	65	63	128
DSX0700F03	7	●	7	35	53	88	DSX1280F03	12.8	●	13	65	63	128
DSX0710F03	7.1	●	8	38	54	92	DSX1290F03	12.9	●	13	65	63	128
DSX0720F03	7.2	●	8	38	54	92	DSX1300F03	13	●	13	65	63	128
DSX0730F03	7.3	●	8	38	54	92	DSX1310F03	13.1	●	14	70	64	134
DSX0740F03	7.4	●	8	38	54	92	DSX1320F03	13.2	●	14	70	64	134
DSX0750F03	7.5	●	8	38	54	92	DSX1330F03	13.3	●	14	70	64	134
DSX0760F03	7.6	●	8	40	54	94	DSX1340F03	13.4	●	14	70	64	134
DSX0770F03	7.7	●	8	40	54	94	DSX1350F03	13.5	●	14	70	64	134
DSX0780F03	7.8	●	8	40	54	94	DSX1360F03	13.6	●	14	70	64	134
DSX0790F03	7.9	●	8	40	54	94	DSX1370F03	13.7	●	14	70	64	134
DSX0800F03	8	●	8	40	54	94	DSX1380F03	13.8	●	14	70	64	134
DSX0810F03	8.1	●	9	43	55	100	DSX1390F03	13.9	●	14	70	64	134
DSX0820F03	8.2	●	9	43	55	100	DSX1400F03	14	●	14	70	64	134
DSX0830F03	8.3	●	9	43	55	100	DSX1410F03	14.1	●	15	75	65	140
DSX0840F03	8.4	●	9	43	55	100	DSX1420F03	14.2	●	15	75	65	140
DSX0850F03	8.5	●	9	43	55	100	DSX1430F03	14.3	●	15	75	65	140
DSX0860F03	8.6	●	9	45	55	100	DSX1440F03	14.4	●	15	75	65	140
DSX0870F03	8.7	●	9	45	55	100	DSX1450F03	14.5	●	15	75	65	140

● : Line up



Metric	$\varnothing D_c$	AH180	$\varnothing D_s$	ℓ	ℓ_s	L
DSX1460F03	14.6	●	15	75	65	140
DSX1470F03	14.7	●	15	75	65	140
DSX1480F03	14.8	●	15	75	65	140
DSX1490F03	14.9	●	15	75	65	140
DSX1500F03	15	●	15	75	65	140
DSX1510F03	15.1	●	16	80	66	146
DSX1520F03	15.2	●	16	80	66	146
DSX1530F03	15.3	●	16	80	66	146
DSX1540F03	15.4	●	16	80	66	146
DSX1550F03	15.5	●	16	80	66	146
DSX1560F03	15.6	●	16	80	66	146
DSX1570F03	15.7	●	16	80	66	146
DSX1580F03	15.8	●	16	80	66	146
DSX1590F03	15.9	●	16	80	66	146
DSX1600F03	16	●	16	80	66	146
DSX1650F03	16.5	●	17	85	67	152
DSX1700F03	17	●	17	85	67	152
DSX1750F03	17.5	●	18	90	68	158
DSX1800F03	18	●	18	90	68	158
DSX1850F03	18.5	●	19	95	69	164
DSX1900F03	19	●	19	95	69	164
DSX1950F03	19.5	●	20	100	70	170
DSX2000F03	20	●	20	100	70	170

● : Line up

Reference pages

Standard cutting conditions → E049



2-effective Drill

GIGA-JET DRILL

DSX-F05

Soliddrill with 140° point angle with oil hole, L/D = 5, dia = ø3 - ø20 mm

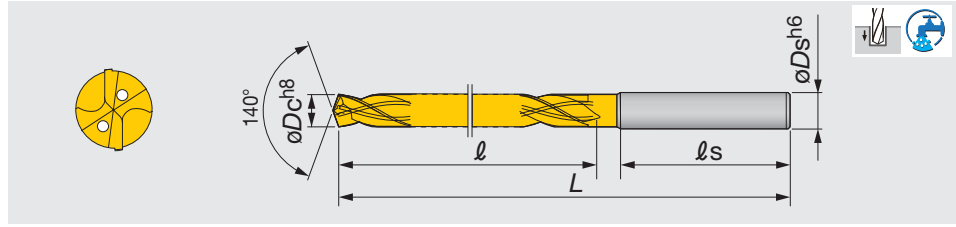

Metric	øDc	AH180	øDs	ℓ	ℓs	L	Metric	øDc	AH180	øDs	ℓ	ℓs	L
DSX0300F05	3	●	3	24	48	77	DSX0880F05	8.8	●	9	72	55	127
DSX0310F05	3.1	●	4	28	48	81	DSX0890F05	8.9	●	9	72	55	127
DSX0320F05	3.2	●	4	28	48	81	DSX0900F05	9	●	9	72	55	127
DSX0330F05	3.3	●	4	28	48	81	DSX0910F05	9.1	●	10	76	56	136
DSX0340F05	3.4	●	4	28	48	81	DSX0920F05	9.2	●	10	76	56	136
DSX0350F05	3.5	●	4	28	48	81	DSX0930F05	9.3	●	10	76	56	136
DSX0360F05	3.6	●	4	32	48	85	DSX0940F05	9.4	●	10	76	56	136
DSX0370F05	3.7	●	4	32	48	85	DSX0950F05	9.5	●	10	76	56	136
DSX0380F05	3.8	●	4	32	48	85	DSX0960F05	9.6	●	10	80	56	136
DSX0390F05	3.9	●	4	32	48	85	DSX0970F05	9.7	●	10	80	56	136
DSX0400F05	4	●	4	32	48	85	DSX0980F05	9.8	●	10	80	56	136
DSX0410F05	4.1	●	5	36	50	91	DSX0990F05	9.9	●	10	80	56	136
DSX0420F05	4.2	●	5	36	50	91	DSX1000F05	10	●	10	80	56	136
DSX0430F05	4.3	●	5	36	50	91	DSX1010F05	10.1	●	11	84	61	149
DSX0440F05	4.4	●	5	36	50	91	DSX1020F05	10.2	●	11	84	61	149
DSX0450F05	4.5	●	5	36	50	91	DSX1030F05	10.3	●	11	84	61	149
DSX0460F05	4.6	●	5	40	50	94	DSX1040F05	10.4	●	11	84	61	149
DSX0470F05	4.7	●	5	40	50	94	DSX1050F05	10.5	●	11	84	61	149
DSX0480F05	4.8	●	5	40	50	94	DSX1060F05	10.6	●	11	88	61	149
DSX0490F05	4.9	●	5	40	50	94	DSX1070F05	10.7	●	11	88	61	149
DSX0500F05	5	●	5	40	50	94	DSX1080F05	10.8	●	11	88	61	149
DSX0510F05	5.1	●	6	44	52	96	DSX1090F05	10.9	●	11	88	61	149
DSX0520F05	5.2	●	6	44	52	96	DSX1100F05	11	●	11	88	61	149
DSX0530F05	5.3	●	6	44	52	96	DSX1110F05	11.1	●	12	92	62	158
DSX0540F05	5.4	●	6	44	52	96	DSX1120F05	11.2	●	12	92	62	158
DSX0550F05	5.5	●	6	44	52	96	DSX1130F05	11.3	●	12	92	62	158
DSX0560F05	5.6	●	6	48	52	100	DSX1140F05	11.4	●	12	92	62	158
DSX0570F05	5.7	●	6	48	52	100	DSX1150F05	11.5	●	12	92	62	158
DSX0580F05	5.8	●	6	48	52	100	DSX1160F05	11.6	●	12	96	62	158
DSX0590F05	5.9	●	6	48	52	100	DSX1170F05	11.7	●	12	96	62	158
DSX0600F05	6	●	6	48	52	100	DSX1180F05	11.8	●	12	96	62	158
DSX0610F05	6.1	●	7	52	53	105	DSX1190F05	11.9	●	12	96	62	158
DSX0620F05	6.2	●	7	52	53	105	DSX1200F05	12	●	12	96	62	158
DSX0630F05	6.3	●	7	52	53	105	DSX1210F05	12.1	●	13	104	63	167
DSX0640F05	6.4	●	7	52	53	105	DSX1220F05	12.2	●	13	104	63	167
DSX0650F05	6.5	●	7	52	53	105	DSX1230F05	12.3	●	13	104	63	167
DSX0660F05	6.6	●	7	56	53	109	DSX1240F05	12.4	●	13	104	63	167
DSX0670F05	6.7	●	7	56	53	109	DSX1250F05	12.5	●	13	104	63	167
DSX0680F05	6.8	●	7	56	53	109	DSX1260F05	12.6	●	13	104	63	167
DSX0690F05	6.9	●	7	56	53	109	DSX1270F05	12.7	●	13	104	63	167
DSX0700F05	7	●	7	56	53	109	DSX1280F05	12.8	●	13	104	63	167
DSX0710F05	7.1	●	8	60	54	114	DSX1290F05	12.9	●	13	104	63	167
DSX0720F05	7.2	●	8	60	54	114	DSX1300F05	13	●	13	104	63	167
DSX0730F05	7.3	●	8	60	54	114	DSX1310F05	13.1	●	14	112	64	176
DSX0740F05	7.4	●	8	60	54	114	DSX1320F05	13.2	●	14	112	64	176
DSX0750F05	7.5	●	8	60	54	114	DSX1330F05	13.3	●	14	112	64	176
DSX0760F05	7.6	●	8	64	54	118	DSX1340F05	13.4	●	14	112	64	176
DSX0770F05	7.7	●	8	64	54	118	DSX1350F05	13.5	●	14	112	64	176
DSX0780F05	7.8	●	8	64	54	118	DSX1360F05	13.6	●	14	112	64	176
DSX0790F05	7.9	●	8	64	54	118	DSX1370F05	13.7	●	14	112	64	176
DSX0800F05	8	●	8	64	54	118	DSX1380F05	13.8	●	14	112	64	176
DSX0810F05	8.1	●	9	68	55	127	DSX1390F05	13.9	●	14	112	64	176
DSX0820F05	8.2	●	9	68	55	127	DSX1400F05	14	●	14	112	64	176
DSX0830F05	8.3	●	9	68	55	127	DSX1410F05	14.1	●	15	120	65	185
DSX0840F05	8.4	●	9	68	55	127	DSX1420F05	14.2	●	15	120	65	185
DSX0850F05	8.5	●	9	68	55	127	DSX1430F05	14.3	●	15	120	65	185
DSX0860F05	8.6	●	9	72	55	127	DSX1440F05	14.4	●	15	120	65	185
DSX0870F05	8.7	●	9	72	55	127	DSX1450F05	14.5	●	15	120	65	185

● : Line up



Metric	$\varnothing D_c$	AH180	$\varnothing D_s$	ℓ	ℓ_s	L
DSX1460F05	14.6	●	15	120	65	185
DSX1470F05	14.7	●	15	120	65	185
DSX1480F05	14.8	●	15	120	65	185
DSX1490F05	14.9	●	15	120	65	185
DSX1500F05	15	●	15	120	65	185
DSX1510F05	15.1	●	16	128	66	194
DSX1520F05	15.2	●	16	128	66	194
DSX1530F05	15.3	●	16	128	66	194
DSX1540F05	15.4	●	16	128	66	194
DSX1550F05	15.5	●	16	128	66	194
DSX1560F05	15.6	●	16	128	66	194
DSX1570F05	15.7	●	16	128	66	194
DSX1580F05	15.8	●	16	128	66	194
DSX1590F05	15.9	●	16	128	66	194
DSX1600F05	16	●	16	128	66	194
DSX1650F05	16.5	●	17	136	67	203
DSX1700F05	17	●	17	136	67	203
DSX1750F05	17.5	●	18	144	68	212
DSX1800F05	18	●	18	144	68	212
DSX1850F05	18.5	●	19	152	69	221
DSX1900F05	19	●	19	152	69	221
DSX1950F05	19.5	●	20	160	70	230
DSX2000F05	20	●	20	160	70	230

● : Line up

Reference pages

Standard cutting conditions → E049



GIGAJETDRILL

DSX-F08

Soliddrill with 140° point angle with oil hole, L/D = 8, dia = ø3 - ø16 mm

2-effective Drill

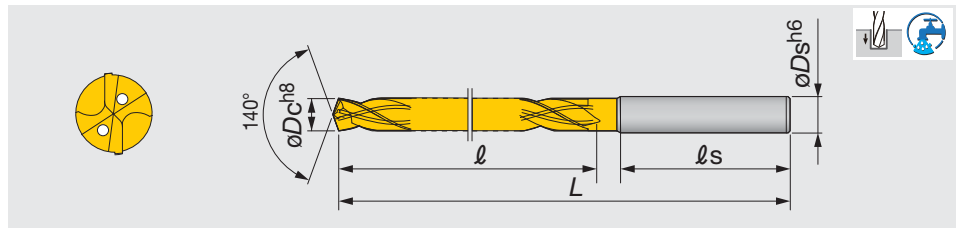

Metric	øDc	AH180	øDs	l	ls	L	Metric	øDc	AH180	øDs	l	ls	L
DSX0300F08	3	●	3	33	48	86	DSX0880F08	8.8		9	99	55	154
DSX0310F08	3.1		4	39	48	92	DSX0890F08	8.9		9	99	55	154
DSX0320F08	3.2		4	39	48	92	DSX0900F08	9	●	9	99	55	154
DSX0330F08	3.3		4	39	48	92	DSX0910F08	9.1		10	105	56	166
DSX0340F08	3.4		4	39	48	92	DSX0920F08	9.2		10	105	56	166
DSX0350F08	3.5	●	4	39	48	92	DSX0930F08	9.3		10	105	56	166
DSX0360F08	3.6		4	44	48	97	DSX0940F08	9.4		10	105	56	166
DSX0370F08	3.7		4	44	48	97	DSX0950F08	9.5	●	10	105	56	166
DSX0380F08	3.8		4	44	48	97	DSX0960F08	9.6		10	110	56	166
DSX0390F08	3.9		4	44	48	97	DSX0970F08	9.7		10	110	56	166
DSX0400F08	4	●	4	44	48	97	DSX0980F08	9.8		10	110	56	166
DSX0410F08	4.1		5	50	50	105	DSX0990F08	9.9		10	110	56	166
DSX0420F08	4.2		5	50	50	105	DSX1000F08	10	●	10	110	56	166
DSX0430F08	4.3		5	50	50	105	DSX1010F08	10.1		11	116	61	182
DSX0440F08	4.4		5	50	50	105	DSX1020F08	10.2		11	116	61	182
DSX0450F08	4.5	●	5	50	50	105	DSX1030F08	10.3		11	116	61	182
DSX0460F08	4.6		5	55	50	110	DSX1040F08	10.4		11	116	61	182
DSX0470F08	4.7		5	55	50	110	DSX1050F08	10.5	●	11	116	61	182
DSX0480F08	4.8		5	55	50	110	DSX1060F08	10.6		11	121	61	182
DSX0490F08	4.9		5	55	50	110	DSX1070F08	10.7		11	121	61	182
DSX0500F08	5	●	5	55	50	110	DSX1080F08	10.8		11	121	61	182
DSX0510F08	5.1	●	6	61	52	113	DSX1090F08	10.9		11	121	61	182
DSX0520F08	5.2		6	61	52	113	DSX1100F08	11	●	11	121	61	182
DSX0530F08	5.3		6	61	52	113	DSX1110F08	11.1		12	127	62	194
DSX0540F08	5.4		6	61	52	113	DSX1120F08	11.2		12	127	62	194
DSX0550F08	5.5	●	6	61	52	113	DSX1130F08	11.3		12	127	62	194
DSX0560F08	5.6		6	66	52	118	DSX1140F08	11.4		12	127	62	194
DSX0570F08	5.7		6	66	52	118	DSX1150F08	11.5	●	12	127	62	194
DSX0580F08	5.8		6	66	52	118	DSX1160F08	11.6		12	132	62	194
DSX0590F08	5.9		6	66	52	118	DSX1170F08	11.7		12	132	62	194
DSX0600F08	6	●	6	66	52	118	DSX1180F08	11.8		12	132	62	194
DSX0610F08	6.1		7	72	53	125	DSX1190F08	11.9		12	132	62	194
DSX0620F08	6.2		7	72	53	125	DSX1200F08	12	●	12	132	62	194
DSX0630F08	6.3		7	72	53	125	DSX1210F08	12.1		13	143	63	206
DSX0640F08	6.4		7	72	53	125	DSX1220F08	12.2		13	143	63	206
DSX0650F08	6.5	●	7	72	53	125	DSX1230F08	12.3		13	143	63	206
DSX0660F08	6.6		7	77	53	130	DSX1240F08	12.4		13	143	63	206
DSX0670F08	6.7		7	77	53	130	DSX1250F08	12.5	●	13	143	63	206
DSX0680F08	6.8		7	77	53	130	DSX1260F08	12.6		13	143	63	206
DSX0690F08	6.9		7	77	53	130	DSX1270F08	12.7		13	143	63	206
DSX0700F08	7	●	7	77	53	130	DSX1280F08	12.8		13	143	63	206
DSX0710F08	7.1		8	83	54	137	DSX1290F08	12.9		13	143	63	206
DSX0720F08	7.2		8	83	54	137	DSX1300F08	13	●	13	143	63	206
DSX0730F08	7.3		8	83	54	137	DSX1310F08	13.1		14	154	64	218
DSX0740F08	7.4		8	83	54	137	DSX1320F08	13.2		14	154	64	218
DSX0750F08	7.5	●	8	83	54	137	DSX1330F08	13.3		14	154	64	218
DSX0760F08	7.6		8	88	54	142	DSX1340F08	13.4		14	154	64	218
DSX0770F08	7.7		8	88	54	142	DSX1350F08	13.5	●	14	154	64	218
DSX0780F08	7.8		8	88	54	142	DSX1360F08	13.6		14	154	64	218
DSX0790F08	7.9		8	88	54	142	DSX1370F08	13.7		14	154	64	218
DSX0800F08	8	●	8	88	54	142	DSX1380F08	13.8		14	154	64	218
DSX0810F08	8.1		9	94	55	154	DSX1390F08	13.9		14	154	64	218
DSX0820F08	8.2		9	94	55	154	DSX1400F08	14	●	14	154	64	218
DSX0830F08	8.3	●	9	94	55	154	DSX1410F08	14.1		15	165	65	230
DSX0840F08	8.4		9	94	55	154	DSX1420F08	14.2		15	165	65	230
DSX0850F08	8.5	●	9	94	55	154	DSX1430F08	14.3		15	165	65	230
DSX0860F08	8.6		9	99	55	154	DSX1440F08	14.4		15	165	65	230
DSX0870F08	8.7		9	99	55	154	DSX1450F08	14.5	●	15	165	65	230

● : Line up



Metric	øDc	AH180	øDs	ℓ	ℓs	L
DSX1460F08	14.6		15	165	65	230
DSX1470F08	14.7		15	165	65	230
DSX1480F08	14.8		15	165	65	230
DSX1490F08	14.9		15	165	65	230
DSX1500F08	15	●	15	165	65	230
DSX1510F08	15.1		16	176	66	242
DSX1520F08	15.2		16	176	66	242
DSX1530F08	15.3		16	176	66	242
DSX1540F08	15.4		16	176	66	242
DSX1550F08	15.5	●	16	176	66	242
DSX1560F08	15.6		16	176	66	242
DSX1570F08	15.7		16	176	66	242
DSX1580F08	15.8		16	176	66	242
DSX1590F08	15.9		16	176	66	242
DSX1600F08	16	●	16	176	66	242

● : Line up

STANDARD CUTTING CONDITIONS

ISO	Workpiece material	Examples JIS (ISO)	Hardness	Cutting speed: Vc (sfm)			Feed: f (ipr)		
				ø0.118 - ø0.236	ø0.236 - ø0.394	ø0.394 - ø0.787	ø0.118 - ø0.236	ø0.236 - ø0.394	ø0.394 - ø0.787
P	Mild steels, Low carbon steels	1018, 1020, 1026, etc.	< 180HB	230 - 459	262 - 525	295 - 623	0.006 - 0.010	0.008 - 0.014	0.010 - 0.016
	Carbon steels, Alloy steels	1045, 1055, etc.	180 ~ 300HB	164 - 427	230 - 525	262 - 558	0.006 - 0.010	0.008 - 0.014	0.010 - 0.016
	High alloy steels etc.	4140, 8620, etc.	250 ~ 350HB	131 - 328	197 - 459	197 - 525	0.004 - 0.008	0.006 - 0.012	0.006 - 0.012
M	Stainless steels	304SS, 316SS, 17-4 PH, etc.	< 200HB	98 - 230	164 - 328	164 - 394	0.004 - 0.008	0.004 - 0.010	0.006 - 0.014
K	Gray cast irons	Class 25, Class 30, etc.	< 200HB	262 - 459	328 - 525	328 - 591	0.006 - 0.014	0.008 - 0.016	0.010 - 0.020
	Ductile cast irons	60-40-18, 60-55-06, etc.	< 300HB	230 - 459	262 - 492	262 - 558	0.006 - 0.014	0.008 - 0.016	0.010 - 0.018
N	Aluminum alloys	6061, 7075, etc.	-	262 - 525	328 - 591	328 - 623	0.006 - 0.014	0.008 - 0.018	0.010 - 0.024
S	Titanium alloys	Ti-6Al-4V, etc.	-	82 - 197	98 - 262	98 - 262	0.004 - 0.008	0.004 - 0.010	0.006 - 0.014
	Heat-resistant alloys	Inconel 718, etc.	250HB <	33 - 98	33 - 131	33 - 131	0.001 - 0.004	0.002 - 0.006	0.004 - 0.010
H	Hardened material		< 40HRC	66 - 164	98 - 197	98 - 197	0.003 - 0.004	0.004 - 0.006	0.005 - 0.008

Note: • The cutting parameters shown in the table are merely a starting guideline for general machining.
 • Values should be varied depending on the power or rigidity of the machine to be used. For the smaller side of drill diameters, select lower feeds.

• Chip packing in the oil holes may cause drill breakage. A filter preventing the circulation of chips should be used on coolant supply.
 • Inconel is trademark of Huntington Alloys, Inc.

• No. of revolutions (min⁻¹) = Cutting speed × 1000 ÷ 3.14 ÷ Tool diameter
 • Table feed (mm/min) = No. of revolutions × Feed per revolution



2-effective Drill

GIGAMINIDRILL

DSM

Micro solid drill with std. shank size of $\varnothing 3$ mm, without coolant hole, dia. = $\varnothing 0.1$ mm - $\varnothing 3$ mm, L/D = 5 - 15

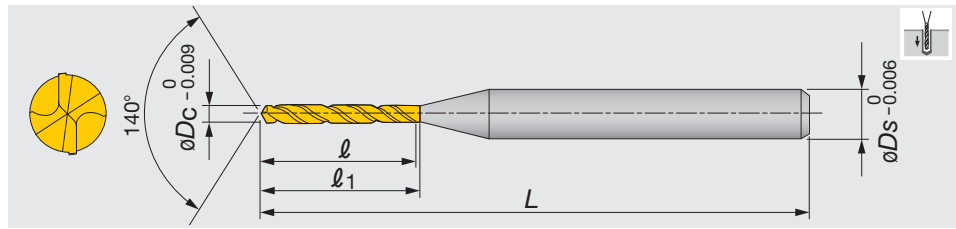

Metric	$\varnothing D_c$	Coated YH170 YH180	$\varnothing D_s$	ℓ	ℓ_1	L	Metric	$\varnothing D_c$	Coated YH170 YH180	$\varnothing D_s$	ℓ	ℓ_1	L
DSM0010G10	0.1	●	3	1.15	1.4	38	DSM0068G10	0.68		3	8.6	9.2	38
DSM0011G10	0.11	●	3	1.25	1.5	38	DSM0069G10	0.69		3	8.6	9.2	38
DSM0012G10	0.12	●	3	1.35	1.6	38	DSM0070G10	0.7	●	3	8.6	9.2	38
DSM0013G10	0.13	●	3	1.55	1.8	38	DSM0071G10	0.71		3	9.2	9.8	38
DSM0014G10	0.14	●	3	1.65	1.9	38	DSM0072G10	0.72		3	9.2	9.8	38
DSM0015G10	0.15	●	3	1.75	2	38	DSM0073G10	0.73		3	9.2	9.8	38
DSM0016G10	0.16	●	3	1.85	2.1	38	DSM0074G10	0.74		3	9.2	9.8	38
DSM0017G10	0.17	●	3	1.95	2.2	38	DSM0075G10	0.75	●	3	9.2	9.8	38
DSM0018G10	0.18	●	3	2.15	2.4	38	DSM0076G10	0.76		3	9.9	10.5	38
DSM0019G10	0.19	●	3	2.25	2.5	38	DSM0077G10	0.77		3	9.9	10.5	38
DSM0020G10	0.2	●	3	2.35	2.6	38	DSM0078G10	0.78		3	9.9	10.5	38
DSM0021G10	0.21	●	3	2.45	2.7	38	DSM0079G10	0.79		3	9.9	10.5	38
DSM0022G10	0.22	●	3	2.55	2.8	38	DSM0080G10	0.8	●	3	9.9	10.5	38
DSM0023G10	0.23	●	3	2.75	3	38	DSM0081G10	0.81		3	10.5	11.1	38
DSM0024G10	0.24	●	3	2.85	3.1	38	DSM0082G10	0.82		3	10.5	11.1	38
DSM0025G10	0.25	●	3	3	3.3	38	DSM0083G10	0.83		3	10.5	11.1	38
DSM0026G10	0.26	●	3	3.1	3.4	38	DSM0084G10	0.84		3	10.5	11.1	38
DSM0027G10	0.27	●	3	3.2	3.5	38	DSM0085G10	0.85		3	10.5	11.1	38
DSM0028G10	0.28	●	3	3.4	3.7	38	DSM0086G10	0.86		3	9.9	10.5	38
DSM0029G10	0.29	●	3	3.5	3.8	38	DSM0087G10	0.87		3	9.9	10.5	38
DSM0030G10	0.3	●	3	3.9	4.2	38	DSM0088G10	0.88	●	3	9.9	10.5	38
DSM0031G15	0.31	●	3	5.6	5.9	38	DSM0089G10	0.89		3	9.9	10.5	38
DSM0032G15	0.32	●	3	5.6	5.9	38	DSM0090G10	0.9	●	3	9.9	10.5	38
DSM0033G15	0.33	●	3	5.6	5.9	38	DSM0091G10	0.91		3	10.5	11.1	38
DSM0034G15	0.34	●	3	5.6	5.9	38	DSM0092G10	0.92		3	10.5	11.1	38
DSM0035G15	0.35	●	3	5.6	5.9	38	DSM0093G10	0.93		3	10.5	11.1	38
DSM0036G15	0.36	●	3	6.5	6.8	38	DSM0094G10	0.94		3	10.5	11.1	38
DSM0037G15	0.37	●	3	6.5	6.8	38	DSM0095G10	0.95		3	10.5	11.1	38
DSM0038G15	0.38	●	3	6.5	6.8	38	DSM0096G10	0.96		3	11	11.6	38
DSM0039G15	0.39	●	3	6.5	6.8	38	DSM0097G10	0.97	●	3	11	11.6	38
DSM0040G15	0.4	●	3	6.5	6.8	38	DSM0098G10	0.98		3	11	11.6	38
DSM0041G15	0.41	●	3	7.4	7.7	38	DSM0099G10	0.99		3	11	11.6	38
DSM0042G15	0.42	●	3	7.4	7.7	38	DSM0100G10	1	●	3	11.5	12.1	38
DSM0043G15	0.43	●	3	7.4	7.7	38	DSM0101G05	1.01		3	8	8.6	38
DSM0044G15	0.44	●	3	7.4	7.7	38	DSM0102G05	1.02		3	8	8.6	38
DSM0045G15	0.45	●	3	7.4	7.7	38	DSM0103G05	1.03		3	8	8.6	38
DSM0046G15	0.46	●	3	8.1	8.7	38	DSM0104G05	1.04		3	8	8.6	38
DSM0047G15	0.47	●	3	8.1	8.7	38	DSM0105G05	1.05		3	8	8.6	38
DSM0048G15	0.48	●	3	8.1	8.7	38	DSM0106G05	1.06		3	8	8.6	38
DSM0049G15	0.49	●	3	8.1	8.7	38	DSM0107G05	1.07		3	8	8.6	38
DSM0050G15	0.5	●	3	8.1	8.7	38	DSM0108G05	1.08	●	3	8	8.6	38
DSM0051G10	0.51		3	6.6	7.2	38	DSM0109G05	1.09		3	8	8.6	38
DSM0052G10	0.52		3	6.6	7.2	38	DSM0110G05	1.1	●	3	8	8.6	38
DSM0053G10	0.53		3	6.6	7.2	38	DSM0111G05	1.11		3	8.9	9.5	38
DSM0054G10	0.54		3	6.6	7.2	38	DSM0112G05	1.12		3	8.9	9.5	38
DSM0055G10	0.55	●	3	6.6	7.2	38	DSM0113G05	1.13		3	8.9	9.5	38
DSM0056G10	0.56		3	7.3	7.9	38	DSM0114G05	1.14		3	8.9	9.5	38
DSM0057G10	0.57		3	7.3	7.9	38	DSM0115G05	1.15		3	8.9	9.5	38
DSM0058G10	0.58		3	7.3	7.9	38	DSM0116G05	1.16		3	8.9	9.5	38
DSM0059G10	0.59		3	7.3	7.9	38	DSM0117G05	1.17		3	8.9	9.5	38
DSM0060G10	0.6	●	3	7.3	7.9	38	DSM0118G05	1.18		3	8.9	9.5	38
DSM0061G10	0.61		3	7.9	8.5	38	DSM0119G05	1.19		3	8.9	9.5	38
DSM0062G10	0.62		3	7.9	8.5	38	DSM0120G05	1.2	●	3	8.9	9.5	38
DSM0063G10	0.63		3	7.9	8.5	38	DSM0121G05	1.21		3	9.7	10.3	38
DSM0064G10	0.64		3	7.9	8.5	38	DSM0122G05	1.22		3	9.7	10.3	38
DSM0065G10	0.65	●	3	7.9	8.5	38	DSM0123G05	1.23		3	9.7	10.3	38
DSM0066G10	0.66		3	8.6	9.2	38	DSM0124G05	1.24		3	9.7	10.3	38
DSM0067G10	0.67		3	8.6	9.2	38	DSM0125G05	1.25		3	9.7	10.3	38

● : Line up



Metric	øDc	Coated		øDs	ℓ	ℓ1	L	Metric	øDc	Coated		øDs	ℓ	ℓ1	L
		YH170	YH180							YH170	YH180				
DSM0126G05	1.26			3	9.7	10.3	38	DSM0181G05	1.81			3	14.5	15.1	45
DSM0127G05	1.27			3	9.7	10.3	38	DSM0182G05	1.82	●		3	14.5	15.1	45
DSM0128G05	1.28			3	9.7	10.3	38	DSM0183G05	1.83			3	14.5	15.1	45
DSM0129G05	1.29			3	9.7	10.3	38	DSM0184G05	1.84			3	14.5	15.1	45
DSM0130G05	1.3	●		3	9.7	10.3	38	DSM0185G05	1.85	●		3	14.5	15.1	45
DSM0131G05	1.31			3	10.5	11.1	38	DSM0186G05	1.86			3	14.5	15.1	45
DSM0132G05	1.32			3	10.5	11.1	38	DSM0187G05	1.87			3	14.5	15.1	45
DSM0133G05	1.33			3	10.5	11.1	38	DSM0188G05	1.88			3	14.5	15.1	45
DSM0134G05	1.34			3	10.5	11.1	38	DSM0189G05	1.89			3	14.5	15.1	45
DSM0135G05	1.35			3	10.5	11.1	38	DSM0190G05	1.9	●		3	14.5	15.1	45
DSM0136G05	1.36			3	10.5	11.1	38	DSM0191G05	1.91			3	15.3	15.9	45
DSM0137G05	1.37			3	10.5	11.1	38	DSM0192G05	1.92			3	15.3	15.9	45
DSM0138G05	1.38			3	10.5	11.1	38	DSM0193G05	1.93			3	15.3	15.9	45
DSM0139G05	1.39			3	10.5	11.1	38	DSM0194G05	1.94			3	15.3	15.9	45
DSM0140G05	1.4	●		3	10.5	11.1	38	DSM0195G05	1.95	●		3	15.3	15.9	45
DSM0141G05	1.41			3	11.3	11.9	38	DSM0196G05	1.96			3	15.3	15.9	45
DSM0142G05	1.42			3	11.3	11.9	38	DSM0197G05	1.97			3	15.3	15.9	45
DSM0143G05	1.43			3	11.3	11.9	38	DSM0198G05	1.98			3	15.3	15.9	45
DSM0144G05	1.44			3	11.3	11.9	38	DSM0199G05	1.99			3	15.3	15.9	45
DSM0145G05	1.45	●		3	11.3	11.9	38	DSM0200G05	2		●	3	15.3	15.9	45
DSM0146G05	1.46			3	11.3	11.9	38	DSM0201G05	2.01			3	16.1	16.7	45
DSM0147G05	1.47			3	11.3	11.9	38	DSM0202G05	2.02			3	16.1	16.7	45
DSM0148G05	1.48			3	11.3	11.9	38	DSM0203G05	2.03		●	3	16.1	16.7	45
DSM0149G05	1.49			3	11.3	11.9	38	DSM0204G05	2.04			3	16.1	16.7	45
DSM0150G05	1.5	●		3	11.3	11.9	38	DSM0205G05	2.05			3	16.1	16.7	45
DSM0151G05	1.51			3	12.1	12.7	45	DSM0206G05	2.06			3	16.1	16.7	45
DSM0152G05	1.52			3	12.1	12.7	45	DSM0207G05	2.07			3	16.1	16.7	45
DSM0153G05	1.53	●		3	12.1	12.7	45	DSM0208G05	2.08			3	16.1	16.7	45
DSM0154G05	1.54			3	12.1	12.7	45	DSM0209G05	2.09			3	16.1	16.7	45
DSM0155G05	1.55	●		3	12.1	12.7	45	DSM0210G05	2.1		●	3	16.1	16.7	45
DSM0156G05	1.56			3	12.1	12.7	45	DSM0211G05	2.11			3	16.9	17.5	45
DSM0157G05	1.57			3	12.1	12.7	45	DSM0212G05	2.12			3	16.9	17.5	45
DSM0158G05	1.58			3	12.1	12.7	45	DSM0213G05	2.13			3	16.9	17.5	45
DSM0159G05	1.59			3	12.1	12.7	45	DSM0214G05	2.14			3	16.9	17.5	45
DSM0160G05	1.6	●		3	12.1	12.7	45	DSM0215G05	2.15			3	16.9	17.5	45
DSM0161G05	1.61			3	12.9	13.6	45	DSM0216G05	2.16			3	16.9	17.5	45
DSM0162G05	1.62			3	12.9	13.6	45	DSM0217G05	2.17			3	16.9	17.5	45
DSM0163G05	1.63			3	12.9	13.6	45	DSM0218G05	2.18			3	16.9	17.5	45
DSM0164G05	1.64			3	12.9	13.6	45	DSM0219G05	2.19			3	16.9	17.5	45
DSM0165G05	1.65	●		3	12.9	13.6	45	DSM0220G05	2.2		●	3	16.9	17.5	45
DSM0166G05	1.66			3	12.9	13.6	45	DSM0221G05	2.21			3	17.7	18.3	45
DSM0167G05	1.67			3	12.9	13.6	45	DSM0222G05	2.22			3	17.7	18.3	45
DSM0168G05	1.68			3	12.9	13.6	45	DSM0223G05	2.23			3	17.7	18.3	45
DSM0169G05	1.69			3	12.9	13.6	45	DSM0224G05	2.24			3	17.7	18.3	45
DSM0170G05	1.7	●		3	12.9	13.6	45	DSM0225G05	2.25			3	17.7	18.3	45
DSM0171G05	1.71			3	13.7	14.3	45	DSM0226G05	2.26			3	17.7	18.3	45
DSM0172G05	1.72			3	13.7	14.3	45	DSM0227G05	2.27			3	17.7	18.3	45
DSM0173G05	1.73			3	13.7	14.3	45	DSM0228G05	2.28			3	17.7	18.3	45
DSM0174G05	1.74			3	13.7	14.3	45	DSM0229G05	2.29			3	17.7	18.3	45
DSM0175G05	1.75			3	13.7	14.3	45	DSM0230G05	2.3		●	3	17.7	18.3	45
DSM0176G05	1.76			3	13.7	14.3	45	DSM0231G05	2.31			3	18.5	19.1	55
DSM0177G05	1.77			3	13.7	14.3	45	DSM0232G05	2.32			3	18.5	19.1	55
DSM0178G05	1.78			3	13.7	14.3	45	DSM0233G05	2.33			3	18.5	19.1	55
DSM0179G05	1.79			3	13.7	14.3	45	DSM0234G05	2.34			3	18.5	19.1	55
DSM0180G05	1.8	●		3	13.7	14.3	45	DSM0235G05	2.35			3	18.5	19.1	55
								DSM0236G05	2.36			3	18.5	19.1	55
								DSM0237G05	2.37			3	18.5	19.1	55
								DSM0238G05	2.38			3	18.5	19.1	55

Reference pages

Standard cutting conditions → E052

● : Line up



Metric	øDc	Coated		øDs	ℓ	ℓ1	L	Metric	øDc	Coated		øDs	ℓ	ℓ1	L
		YH170	YH180							YH170	YH180				
DSM0239G05	2.39			3	18.5	19.1	55	DSM0270G05	2.7	●		3	20.9	21.5	55
DSM0240G05	2.4	●		3	18.5	19.1	55	DSM0271G05	2.71			3	21.7	22.3	55
DSM0241G05	2.41			3	19.3	19.9	55	DSM0272G05	2.72			3	21.7	22.3	55
DSM0242G05	2.42			3	19.3	19.9	55	DSM0273G05	2.73			3	21.7	22.3	55
DSM0243G05	2.43			3	19.3	19.9	55	DSM0274G05	2.74			3	21.7	22.3	55
DSM0244G05	2.44			3	19.3	19.9	55	DSM0275G05	2.75			3	21.7	22.3	55
DSM0245G05	2.45			3	19.3	19.9	55	DSM0276G05	2.76			3	21.7	22.3	55
DSM0246G05	2.46			3	19.3	19.9	55	DSM0277G05	2.77			3	21.7	22.3	55
DSM0247G05	2.47			3	19.3	19.9	55	DSM0278G05	2.78			3	21.7	22.3	55
DSM0248G05	2.48			3	19.3	19.9	55	DSM0279G05	2.79			3	21.7	22.3	55
DSM0249G05	2.49			3	19.3	19.9	55	DSM0280G05	2.8	●		3	21.7	22.3	55
DSM0250G05	2.5	●		3	19.3	19.9	55	DSM0281G05	2.81			3	22.5	23.1	55
DSM0251G05	2.51			3	20.1	20.7	55	DSM0282G05	2.82			3	22.5	23.1	55
DSM0252G05	2.52			3	20.1	20.7	55	DSM0283G05	2.83			3	22.5	23.1	55
DSM0253G05	2.53			3	20.1	20.7	55	DSM0284G05	2.84			3	22.5	23.1	55
DSM0254G05	2.54			3	20.1	20.7	55	DSM0285G05	2.85			3	22.5	23.1	55
DSM0255G05	2.55			3	20.1	20.7	55	DSM0286G05	2.86			3	22.5	23.1	55
DSM0256G05	2.56	●		3	20.1	20.7	55	DSM0287G05	2.87			3	22.5	23.1	55
DSM0257G05	2.57			3	20.1	20.7	55	DSM0288G05	2.88			3	22.5	23.1	55
DSM0258G05	2.58			3	20.1	20.7	55	DSM0289G05	2.89			3	22.5	23.1	55
DSM0259G05	2.59			3	20.1	20.7	55	DSM0290G05	2.9	●		3	22.5	23.1	55
DSM0260G05	2.6	●		3	20.1	20.7	55	DSM0291G05	2.91			3	23.3	23.9	55
DSM0261G05	2.61			3	20.9	21.5	55	DSM0292G05	2.92			3	23.3	23.9	55
DSM0262G05	2.62			3	20.9	21.5	55	DSM0293G05	2.93			3	23.3	23.9	55
DSM0263G05	2.63			3	20.9	21.5	55	DSM0294G05	2.94			3	23.3	23.9	55
DSM0264G05	2.64			3	20.9	21.5	55	DSM0295G05	2.95			3	23.3	23.9	55
DSM0265G05	2.65			3	20.9	21.5	55	DSM0296G05	2.96			3	23.3	23.9	55
DSM0266G05	2.66			3	20.9	21.5	55	DSM0297G05	2.97			3	23.3	23.9	55
DSM0267G05	2.67			3	20.9	21.5	55	DSM0298G05	2.98			3	23.3	23.9	55
DSM0268G05	2.68			3	20.9	21.5	55	DSM0299G05	2.99			3	23.3	23.9	55
DSM0269G05	2.69			3	20.9	21.5	55	DSM0300G05	3	●		3	23.3	23.9	55

● : Line up

STANDARD CUTTING CONDITIONS

ISO	Workpiece material	Cutting speed: Vc (sfm)			Feed: f (ipr)				
		ø0.1 ~ ø0.3	ø0.3 ~ ø0.5	ø0.5 ~ ø3	ø0.1 ~ ø0.3	ø0.3 ~ ø0.5	ø0.5 ~ ø1	ø1 ~ ø2	ø2 ~ ø3
		(ø0.004" ~ ø0.012")	(ø0.012" ~ ø0.020")	(ø0.020" ~ ø0.118")	(ø0.004" ~ ø0.012")	(ø0.012" ~ ø0.020")	(ø0.020" ~ ø0.039")	(ø0.039" ~ ø0.079")	(ø0.079" ~ ø0.118")
P	Carbon and alloy steels	16 - 66	49 - 98	82 - 197	0.0004 - 0.00016	0.00008 - 0.0004	0.00020 - 0.00020	0.0012 - 0.0035	0.0020 - 0.004
M	Stainless steels	7 - 39	20 - 59	33 - 66	0.00002 - 0.00016	0.00008 - 0.00031	0.00020 - 0.0012	0.0004 - 0.0016	0.0008 - 0.0020
K	Gray cast irons	16 - 49	33 - 82	66 - 164	0.00002 - 0.00016	0.00008 - 0.0005	0.00020 - 0.0012	0.0004 - 0.0024	0.0012 - 0.005
	Ductile cast irons	16 - 49	33 - 82	66 - 164	0.00004 - 0.00012	0.00008 - 0.0004	0.00020 - 0.0008	0.0004 - 0.0020	0.0012 - 0.004
N	Aluminum alloys	33 - 66	33 - 98	66 - 164	0.00004 - 0.0004	0.00020 - 0.0012	0.0004 - 0.0020	0.0016 - 0.006	0.0024 - 0.008
	Copper / Brass	33 - 66	33 - 98	66 - 164	0.00004 - 0.0004	0.00020 - 0.0012	0.0004 - 0.0020	0.0016 - 0.006	0.0024 - 0.008
S	Heat-resistant alloys	7 - 20	16 - 33	26 - 66	0.00002 - 0.00012	0.00008 - 0.00016	0.00008 - 0.00016	0.00008 - 0.00016	Not recommended
H	Hardened material	13 - 26	20 - 33	20 - 52	0.00002 - 0.00008	0.00004 - 0.00020	0.00020 - 0.0008	0.0004 - 0.0012	0.0008 - 0.0024

Note: ● When the drilling depth is deeper than L/D = 5, use drill pecking every 10 to 50% of the drill diameter.
 ● The above cutting conditions are applied to when a water soluble cutting fluid is used. For drilling a hole smaller than ø0.012", use of a starting drill is recommended.

● When setting the drill, the drill run out should be within 0.00008" on the taper. (Especially for the drill diameter smaller than ø0.020")

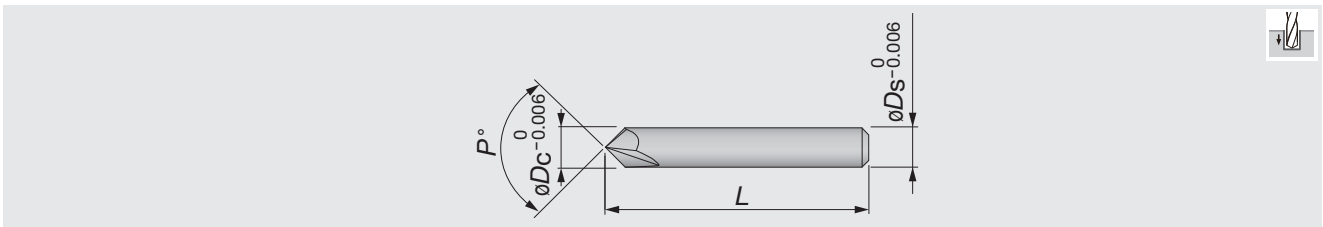

Metric	ϕD_c	YH170	ϕD_s	L	P°
DSM-CP90	3	●	3	38.1	90
DSM-CP140	3	●	3	38.1	140

● : Line up

STANDARD CUTTING CONDITIONS

ISO	Workpiece material	Cutting speed: Vc (sfm)	Feed: f (ipr)	
			DSM-CP90	DSM-CP140
P	Carbon, Mild and Alloy steels	98 - 262	0.00039 - 0.00236	0.00118 - 0.00314
K	Gray and ductile cast irons	98 - 262	0.00078 - 0.00236	0.00196 - 0.00393
N	Aluminum alloys	197 - 394	0.00078 - 0.0039	0.00196 - 0.0059
M	Stainless steels	49 - 131	0.00039 - 0.00118	0.00078 - 0.00236
H	Hardened material (~45HRC)	33 - 131	Not recommended	0.00039 - 0.00196

Notes: • For hard materials and stainless steels which have work-hardening nature, DSM-CP140 is recommended.
 • Above cutting conditions are of using a water-soluble cutting fluid. When using a water-insoluble type, set the cutting speed to lower side.



DMXU L/D=2 (VS type)

Solidrill with 130° point angle without oil hole & shank size equal to drill dia., L/D = 2,
dia = ø0.111" - ø0.781"

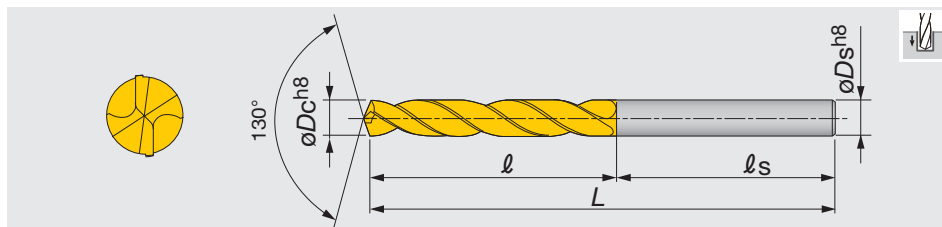

Inch	øDc	AH170	øDs	ℓ	ℓs	L	Inch	øDc	AH170	øDs	ℓ	ℓs	L
DMXU1110VS	#34	●	0.111	0.630	1.18	1.81	DMXU2900VS	#L	●	0.290	1.34	1.57	2.91
DMXU1130VS	#32	●	0.113	0.630	1.18	1.81	DMXU2950VS	#M	●	0.295	1.34	1.57	2.91
DMXU1160VS	#32	●	0.116	0.630	1.18	1.81	DMXU2969VS	19/64	●	0.297	1.46	1.65	3.11
DMXU1200VS	#31	●	0.120	0.708	1.22	1.93	DMXU3020VS	#N	●	0.302	1.46	1.65	3.11
DMXU1250VS	1/8	●	0.125	0.708	1.22	1.93	DMXU3125VS	5/16	●	0.313	1.46	1.65	3.11
DMXU1285VS	#30	●	0.129	0.708	1.22	1.93	DMXU3160VS	#0	●	0.316	1.46	1.65	3.11
DMXU1360VS	#29	●	0.136	0.787	1.26	2.05	DMXU3230VS	#P	●	0.323	1.46	1.65	3.11
DMXU1405VS	#28	●	0.141	0.787	1.26	2.05	DMXU3281VS	21/64	●	0.328	1.46	1.65	3.11
DMXU1406VS	9/64	●	0.141	0.787	1.26	2.05	DMXU3320VS	#Q	●	0.332	1.46	1.65	3.11
DMXU1440VS	#27	●	0.144	0.787	1.26	2.05	DMXU3390VS	#R	●	0.339	1.57	1.73	3.31
DMXU1470VS	#26	●	0.147	0.886	1.30	2.17	DMXU3438VS	11/32	●	0.344	1.57	1.73	3.31
DMXU1495VS	#25	●	0.150	0.886	1.30	2.17	DMXU3480VS	#S	●	0.348	1.57	1.73	3.31
DMXU1520VS	#24	●	0.152	0.886	1.30	2.17	DMXU3580VS	#T	●	0.358	1.57	1.73	3.31
DMXU1540VS	#23	●	0.154	0.886	1.30	2.17	DMXU3594VS	23/64	●	0.359	1.57	1.73	3.31
DMXU1562VS	5/32	●	0.156	0.886	1.30	2.17	DMXU3680VS	#U	●	0.368	1.57	1.73	3.31
DMXU1570VS	#22	●	0.157	0.886	1.30	2.17	DMXU3750VS	3/8	●	0.375	1.69	1.81	3.50
DMXU1590VS	#21	●	0.159	0.886	1.30	2.17	DMXU3770VS	#V	●	0.377	1.69	1.81	3.50
DMXU1610VS	#20	●	0.161	0.886	1.30	2.17	DMXU3860VS	#W	●	0.386	1.69	1.81	3.50
DMXU1660VS	#19	●	0.166	0.945	1.34	2.28	DMXU3906VS	25/64	●	0.391	1.69	1.81	3.50
DMXU1695VS	#18	●	0.170	0.945	1.34	2.28	DMXU3970VS	#X	●	0.397	1.69	1.81	3.50
DMXU1719VS	11/64	●	0.172	0.945	1.34	2.28	DMXU4040VS	#Y	●	0.404	1.69	1.81	3.50
DMXU1730VS	#17	●	0.173	0.945	1.34	2.28	DMXU4062VS	13/32	●	0.406	1.69	1.81	3.50
DMXU1770VS	#16	●	0.177	0.945	1.34	2.28	DMXU4130VS	#Z	●	0.413	1.69	1.81	3.50
DMXU1800VS	#15	●	0.180	0.945	1.34	2.28	DMXU4219VS	27/64	●	0.422	1.85	1.89	3.74
DMXU1820VS	#14	●	0.182	0.945	1.34	2.28	DMXU4375VS	7/16	●	0.438	1.85	1.89	3.74
DMXU1850VS	#13	●	0.185	0.945	1.34	2.28	DMXU4531VS	29/64	●	0.453	1.85	1.89	3.74
DMXU1875VS	3/16	●	0.188	1.02	1.42	2.44	DMXU4688VS	15/32	●	0.469	2.01	2.01	4.02
DMXU1890VS	#12	●	0.189	1.02	1.42	2.44	DMXU4844VS	31/64	●	0.484	2.01	2.01	4.02
DMXU1910VS	#11	●	0.191	1.02	1.42	2.44	DMXU5000VS	1/2	●	0.500	2.01	2.01	4.02
DMXU1935VS	#10	●	0.194	1.02	1.42	2.44	DMXU5050VS	TUBE	●	0.505	2.01	2.01	4.02
DMXU1960VS	#9	●	0.196	1.02	1.42	2.44	DMXU5156VS	33/64	●	0.516	2.01	2.01	4.02
DMXU1990VS	#8	●	0.199	1.02	1.42	2.44	DMXU5312VS	17/32	●	0.531	2.13	2.09	4.21
DMXU2010VS	#7	●	0.201	1.02	1.42	2.44	DMXU5469VS	35/64	●	0.547	2.13	2.09	4.21
DMXU2031VS	13/64	●	0.203	1.02	1.42	2.44	DMXU5625VS	9/16	●	0.563	2.20	2.17	4.37
DMXU2040VS	#6	●	0.204	1.02	1.42	2.44	DMXU5781VS	37/64	●	0.578	2.20	2.17	4.37
DMXU2055VS	#5	●	0.206	1.02	1.42	2.44	DMXU5937VS	19/32	●	0.594	2.28	2.24	4.53
DMXU2090VS	#4	●	0.209	1.10	1.50	2.60	DMXU6094VS	39/64	●	0.609	2.28	2.24	4.53
DMXU2130VS	#3	●	0.213	1.10	1.50	2.60	DMXU6250VS	5/8	●	0.625	2.28	2.24	4.53
DMXU2188VS	7/32	●	0.219	1.10	1.50	2.60	DMXU6330VS	TUBE	●	0.633	2.36	2.32	4.69
DMXU2210VS	#2	●	0.221	1.10	1.50	2.60	DMXU6406VS	41/64	●	0.641	2.36	2.32	4.69
DMXU2280VS	#1	●	0.228	1.10	1.50	2.60	DMXU6562VS	21/32	●	0.656	2.36	2.32	4.69
DMXU2344VS	#A 15/64	●	0.234	1.10	1.50	2.60	DMXU6875VS	11/16	●	0.688	2.44	2.40	4.85
DMXU2380VS	#B	●	0.238	1.22	1.54	2.76	DMXU7031VS	45/64	●	0.703	2.44	2.40	4.85
DMXU2420VS	#C	●	0.242	1.22	1.54	2.76	DMXU7187VS	23/32	●	0.719	2.52	2.48	5.00
DMXU2460VS	#D	●	0.246	1.22	1.54	2.76	DMXU7344VS	47/64	●	0.734	2.52	2.48	5.00
DMXU2500VS	#E 1/4	●	0.250	1.22	1.54	2.76	DMXU7500VS	3/4	●	0.750	2.60	2.56	5.16
DMXU2570VS	#F	●	0.257	1.22	1.54	2.76	DMXU7590VS	TUBE	●	0.759	2.60	2.60	5.16
DMXU2610VS	#G	●	0.261	1.22	1.54	2.76	DMXU7656VS	49/64	●	0.766	2.60	2.56	5.16
DMXU2656VS	17/64	●	0.266	1.34	1.57	2.91	DMXU7812VS	25/32	●	0.781	2.60	2.56	5.16
DMXU2660VS	#H	●	0.266	1.34	1.57	2.91							
DMXU2720VS	#I	●	0.272	1.34	1.57	2.91							
DMXU2770VS	#J	●	0.277	1.34	1.57	2.91							
DMXU2810VS	#K	●	0.281	1.34	1.57	2.91							
DMXU2812VS	9/32	●	0.281	1.34	1.57	2.91							

- Cutting fluid should be sufficiently supplied to the drill point and the entrance of the hole.
- Use a water soluble cutting fluid containing relatively high content of extreme pressure additive for heavy duty cutting or use a water-insoluble cutting fluid.

● : Line up

Reference pages

Standard cutting conditions → E059

**DMXU L/D=3 (VM type)**

Solidrill with 130° point angle without oil hole & shank size equal to drill dia., L/D = 3,
dia = ø0.199" - ø0.781"

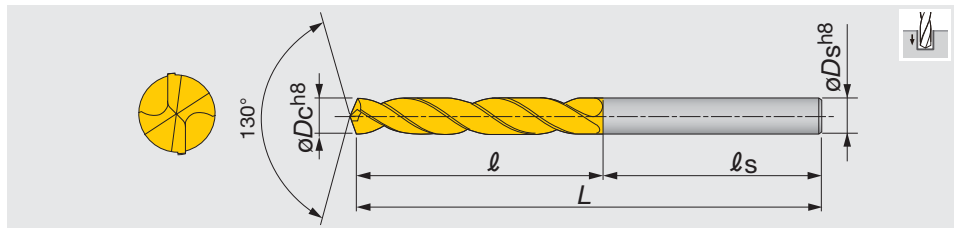

Inch	øDc	AH170	øDs	l	ls	L	Inch	øDc	AH170	øDs	l	ls	L
DMXU1990VM	#8	●	0.199	1.34	1.50	2.83	DMXU5469VM	35/64	●	0.547	3.39	2.40	5.79
DMXU2010VM	#7	●	0.201	1.34	1.50	2.83	DMXU5625VM	9/16	●	0.562	3.50	2.44	5.94
DMXU2031VM	13/64	●	0.203	1.34	1.50	2.83	DMXU5781VM	37/64	●	0.578	3.58	2.44	6.03
DMXU2040VM	#6	●	0.204	1.34	1.50	2.83	DMXU5937VM	19/32	●	0.594	3.70	2.48	6.18
DMXU2055VM	#5	●	0.206	1.34	1.50	2.83	DMXU6094VM	39/64	●	0.609	3.70	2.48	6.18
DMXU2090VM	#4	●	0.209	1.34	1.50	2.83	DMXU6250VM	5/8	●	0.625	3.78	2.52	6.30
DMXU2130VM	#3	●	0.213	1.34	1.50	2.83	DMXU6330VM	TUBE	●	0.633	4.02	2.40	6.57
DMXU2188VM	7/32	●	0.219	1.42	1.50	2.91	DMXU6406VM	41/64	●	0.641	4.02	2.40	6.57
DMXU2210VM	#2	●	0.221	1.34	1.50	2.91	DMXU6562VM	21/32	●	0.656	4.02	2.40	6.57
DMXU2280VM	#1	●	0.228	1.34	1.50	2.91	DMXU6875VM	11/16	●	0.688	4.02	2.40	6.57
DMXU2344VM	#A 15/64	●	0.234	1.61	1.56	3.19	DMXU7031VM	45/64	●	0.703	4.02	2.40	6.57
DMXU2380VM	#B	●	0.238	1.34	1.58	3.19	DMXU7187VM	23/32	●	0.719	4.49	2.40	7.05
DMXU2420VM	#C	●	0.242	1.34	1.58	3.19	DMXU7344VM	47/64	●	0.734	4.49	2.40	7.05
DMXU2460VM	#D	●	0.246	1.34	1.58	3.19	DMXU7500VM	3/4	●	0.750	4.49	2.40	7.05
DMXU2500VM	#E, 1/4	●	0.250	1.34	1.58	3.19	DMXU7590VM	TUBE	●	0.759	4.49	2.40	7.05
DMXU2570VM	#F	●	0.257	1.69	1.57	3.27	DMXU7656VM	49/64	●	0.766	4.49	2.40	7.05
DMXU2610VM	#G	●	0.261	1.69	1.57	3.27	DMXU7812VM	25/32	●	0.781	4.49	2.40	7.05
DMXU2656VM	17/64	●	0.266	1.69	1.57	3.27							
DMXU2660VM	#H	●	0.266	1.69	1.57	3.27							
DMXU2720VM	#I	●	0.272	1.69	1.57	3.27							
DMXU2770VM	#J	●	0.277	1.77	1.65	3.43							
DMXU2810VM	#K	●	0.281	1.77	1.65	3.43							
DMXU2812VM	9/32	●	0.281	1.77	1.65	3.43							
DMXU2900VM	#L	●	0.290	1.77	1.65	3.43							
DMXU2950VM	#M	●	0.295	1.77	1.65	3.43							
DMXU2969VM	19/64	●	0.297	1.89	1.65	3.54							
DMXU3020VM	#N	●	0.302	1.77	1.65	3.54							
DMXU3125VM	5/16	●	0.313	1.77	1.65	3.54							
DMXU3160VM	#O	●	0.316	2.09	1.69	3.78							
DMXU3230VM	#P	●	0.323	2.09	1.69	3.78							
DMXU3281VM	21/64	●	0.328	2.09	1.69	3.78							
DMXU3320VM	#Q	●	0.332	2.09	1.69	3.78							
DMXU3390VM	#R	●	0.339	2.17	1.69	3.86							
DMXU3438VM	11/32	●	0.344	2.17	1.69	3.86							
DMXU3480VM	#S	●	0.348	2.17	1.69	3.86							
DMXU3580VM	#T	●	0.358	2.28	1.73	4.02							
DMXU3594VM	23/64	●	0.359	2.28	1.73	4.02							
DMXU3680VM	#U	●	0.368	2.28	1.73	4.02							
DMXU3750VM	3/8	●	0.375	2.36	1.77	4.13							
DMXU3770VM	#V	●	0.377	2.36	1.77	4.13							
DMXU3860VM	#W	●	0.386	2.36	1.77	4.13							
DMXU3906VM	25/64	●	0.390	2.36	1.77	4.13							
DMXU3970VM	#X	●	0.397	2.60	1.81	4.41							
DMXU4040VM	#Y	●	0.404	2.60	1.81	4.41							
DMXU4062VM	13/32	●	0.406	2.60	1.81	4.41							
DMXU4130VM	#Z	●	0.413	2.60	1.81	4.41							
DMXU4219VM	27/64	●	0.422	2.67	1.81	4.49							
DMXU4375VM	7/16	●	0.438	2.80	1.85	4.65							
DMXU4531VM	29/64	●	0.453	2.87	1.89	4.76							
DMXU4688VM	15/32	●	0.469	2.87	1.89	4.76							
DMXU4844VM	31/64	●	0.484	2.99	2.32	5.32							
DMXU5000VM	1/2	●	0.500	3.07	2.32	5.39							
DMXU5050VM	TUBE	●	0.505	3.07	2.32	5.39							
DMXU5156VM	33/64	●	0.516	3.31	2.36	5.67							
DMXU5312VM	17/32	●	0.531	3.31	2.36	5.67							

- Cutting fluid should be sufficiently supplied to the drill point and the entrance of the hole.
- Use a water soluble cutting fluid containing relatively high content of extreme pressure additive for heavy duty cutting or use a water-insoluble cutting fluid.

● : Line up

Reference pages

Standard cutting conditions → E059



DMX L/D=2 (S type)

Soliddrill with 130° point angle without oil hole & shank size equal to drill dia., L/D = 2, dia = ø3 - ø20 mm

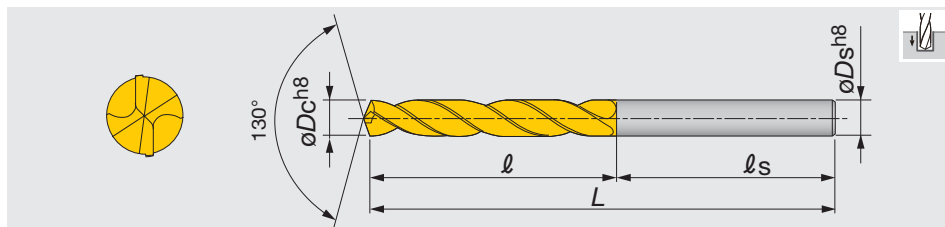

Metric	øDc	AH170	øDs	ℓ	ℓs	L	Metric	øDc	AH170	øDs	ℓ	ℓs	L
DMX030S	3	●	3	16	30	46	DMX088S	8.8	●	8.8	40	44	84
DMX031S	3.1	●	3.1	18	31	49	DMX089S	8.9	●	8.9	40	44	84
DMX032S	3.2	●	3.2	18	31	49	DMX090S	9	●	9	40	44	84
DMX033S	3.3	●	3.3	18	31	49	DMX091S	9.1	●	9.1	40	44	84
DMX034S	3.4	●	3.4	20	32	52	DMX092S	9.2	●	9.2	40	44	84
DMX035S	3.5	●	3.5	20	32	52	DMX093S	9.3	●	9.3	40	44	84
DMX036S	3.6	●	3.6	20	32	52	DMX094S	9.4	●	9.4	40	44	84
DMX037S	3.7	●	3.7	20	32	52	DMX095S	9.5	●	9.5	40	44	84
DMX038S	3.8	●	3.8	22	33	55	DMX096S	9.6	●	9.6	43	46	89
DMX039S	3.9	●	3.9	22	33	55	DMX097S	9.7	●	9.7	43	46	89
DMX040S	4	●	4	22	33	55	DMX098S	9.8	●	9.8	43	46	89
DMX041S	4.1	●	4.1	22	33	55	DMX099S	9.9	●	9.9	43	46	89
DMX042S	4.2	●	4.2	22	33	55	DMX100S	10	●	10	43	46	89
DMX043S	4.3	●	4.3	24	34	58	DMX101S	10.1	●	10.1	43	46	89
DMX044S	4.4	●	4.4	24	34	58	DMX102S	10.2	●	10.2	43	46	89
DMX045S	4.5	●	4.5	24	34	58	DMX103S	10.3	●	10.3	43	46	89
DMX046S	4.6	●	4.6	24	34	58	DMX104S	10.4	●	10.4	43	46	89
DMX047S	4.7	●	4.7	24	34	58	DMX105S	10.5	●	10.5	43	46	89
DMX048S	4.8	●	4.8	26	36	62	DMX106S	10.6	●	10.6	43	46	89
DMX049S	4.9	●	4.9	26	36	62	DMX107S	10.7	●	10.7	47	48	95
DMX050S	5	●	5	26	36	62	DMX108S	10.8	●	10.8	47	48	95
DMX051S	5.1	●	5.1	26	36	62	DMX109S	10.9	●	10.9	47	48	95
DMX052S	5.2	●	5.2	26	36	62	DMX110S	11	●	11	47	48	95
DMX053S	5.3	●	5.3	26	36	62	DMX111S	11.1	●	11.1	47	48	95
DMX054S	5.4	●	5.4	28	38	66	DMX112S	11.2	●	11.2	47	48	95
DMX055S	5.5	●	5.5	28	38	66	DMX113S	11.3	●	11.3	47	48	95
DMX056S	5.6	●	5.6	28	38	66	DMX114S	11.4	●	11.4	47	48	95
DMX057S	5.7	●	5.7	28	38	66	DMX115S	11.5	●	11.5	47	48	95
DMX058S	5.8	●	5.8	28	38	66	DMX116S	11.6	●	11.6	47	48	95
DMX059S	5.9	●	5.9	28	38	66	DMX117S	11.7	●	11.7	47	48	95
DMX060S	6	●	6	28	38	66	DMX118S	11.8	●	11.8	47	48	95
DMX061S	6.1	●	6.1	31	39	70	DMX119S	11.9	●	11.9	51	51	102
DMX062S	6.2	●	6.2	31	39	70	DMX120S	12	●	12	51	51	102
DMX063S	6.3	●	6.3	31	39	70	DMX121S	12.1	●	12.1	51	51	102
DMX064S	6.4	●	6.4	31	39	70	DMX122S	12.2	●	12.2	51	51	102
DMX065S	6.5	●	6.5	31	39	70	DMX123S	12.3	●	12.3	51	51	102
DMX066S	6.6	●	6.6	31	39	70	DMX124S	12.4	●	12.4	51	51	102
DMX067S	6.7	●	6.7	31	39	70	DMX125S	12.5	●	12.5	51	51	102
DMX068S	6.8	●	6.8	34	40	74	DMX126S	12.6	●	12.6	51	51	102
DMX069S	6.9	●	6.9	34	40	74	DMX127S	12.7	●	12.7	51	51	102
DMX070S	7	●	7	34	40	74	DMX128S	12.8	●	12.8	51	51	102
DMX071S	7.1	●	7.1	34	40	74	DMX129S	12.9	●	12.9	51	51	102
DMX072S	7.2	●	7.2	34	40	74	DMX130S	13	●	13	51	51	102
DMX073S	7.3	●	7.3	34	40	74	DMX131S	13.1	●	13.1	51	51	102
DMX074S	7.4	●	7.4	34	40	74	DMX132S	13.2	●	13.2	51	51	102
DMX075S	7.5	●	7.5	34	40	74	DMX133S	13.3	●	13.3	54	53	107
DMX076S	7.6	●	7.6	37	42	79	DMX134S	13.4	●	13.4	54	53	107
DMX077S	7.7	●	7.7	37	42	79	DMX135S	13.5	●	13.5	54	53	107
DMX078S	7.8	●	7.8	37	42	79	DMX136S	13.6	●	13.6	54	53	107
DMX079S	7.9	●	7.9	37	42	79	DMX137S	13.7	●	13.7	54	53	107
DMX080S	8	●	8	37	42	79	DMX138S	13.8	●	13.8	54	53	107
DMX081S	8.1	●	8.1	37	42	79	DMX139S	13.9	●	13.9	54	53	107
DMX082S	8.2	●	8.2	37	42	79	DMX140S	14	●	14	54	53	107
DMX083S	8.3	●	8.3	37	42	79	DMX141S	14.1	●	14.1	56	55	111
DMX084S	8.4	●	8.4	37	42	79	DMX142S	14.2	●	14.2	56	55	111
DMX085S	8.5	●	8.5	37	42	79	DMX143S	14.3	●	14.3	56	55	111
DMX086S	8.6	●	8.6	40	44	84	DMX144S	14.4	●	14.4	56	55	111
DMX087S	8.7	●	8.7	40	44	84	DMX145S	14.5	●	14.5	56	55	111

● : Line up



Metric	$\varnothing D_c$	AH170	$\varnothing D_s$	ℓ	ℓ_s	L
DMX146S	14.6	●	14.6	56	55	111
DMX147S	14.7	●	14.7	56	55	111
DMX148S	14.8	●	14.8	56	55	111
DMX149S	14.9	●	14.9	56	55	111
DMX150S	15	●	15	56	55	111
DMX151S	15.1	●	15.1	58	57	115
DMX152S	15.2	●	15.2	58	57	115
DMX153S	15.3	●	15.3	58	57	115
DMX154S	15.4	●	15.4	58	57	115
DMX155S	15.5	●	15.5	58	57	115
DMX156S	15.6	●	15.6	58	57	115
DMX157S	15.7	●	15.7	58	57	115
DMX158S	15.8	●	15.8	58	57	115
DMX159S	15.9	●	15.9	58	57	115
DMX160S	16	●	16	58	57	115
DMX165S	16.5	●	16.5	60	59	119
DMX170S	17	●	17	60	59	119
DMX175S	17.5	●	17.5	62	61	123
DMX180S	18	●	18	62	61	123
DMX185S	18.5	●	18.5	64	63	127
DMX190S	19	●	19	64	63	127
DMX195S	19.5	●	19.5	66	65	131
DMX200S	20	●	20	66	65	131

- Cutting fluid should be sufficiently supplied to the drill point and the entrance of the hole.
- Use a water-soluble cutting fluid.

● : Line up

Reference pages

Standard cutting conditions → E059



DMX L/D=3 (M type)

Soliddrill with 130° point angle without oil hole & shank size equal to drill dia., L/D = 3, dia = ø3 - ø20 mm

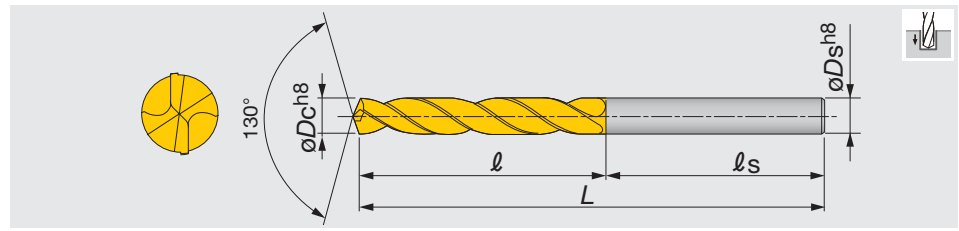

Metric	øDc	AH170	øDs	l	ls	L	Metric	øDc	AH170	øDs	l	ls	L
DMX030M	3	●	3	21	39	60	DMX088M	8.8	●	8.8	55	43	98
DMX031M	3.1	●	3.1	24	36	60	DMX089M	8.9	●	8.9	55	43	98
DMX032M	3.2	●	3.2	24	36	60	DMX090M	9	●	9	55	43	98
DMX033M	3.3	●	3.3	24	36	60	DMX091M	9.1	●	9.1	58	44	102
DMX034M	3.4	●	3.4	24	36	60	DMX092M	9.2	●	9.2	58	44	102
DMX035M	3.5	●	3.5	24	36	60	DMX093M	9.3	●	9.3	58	44	102
DMX036M	3.6	●	3.6	27	33	60	DMX094M	9.4	●	9.4	58	44	102
DMX037M	3.7	●	3.7	27	33	60	DMX095M	9.5	●	9.5	58	44	102
DMX038M	3.8	●	3.8	27	33	60	DMX096M	9.6	●	9.6	60	45	105
DMX039M	3.9	●	3.9	27	33	60	DMX097M	9.7	●	9.7	60	45	105
DMX040M	4	●	4	27	33	60	DMX098M	9.8	●	9.8	60	45	105
DMX041M	4.1	●	4.1	29	34	63	DMX099M	9.9	●	9.9	60	45	105
DMX042M	4.2	●	4.2	29	34	63	DMX100M	10	●	10	60	45	105
DMX043M	4.3	●	4.3	29	34	63	DMX101M	10.1	●	10.1	66	46	112
DMX044M	4.4	●	4.4	29	34	63	DMX102M	10.2	●	10.2	66	46	112
DMX045M	4.5	●	4.5	29	34	63	DMX103M	10.3	●	10.3	66	46	112
DMX046M	4.6	●	4.6	32	36	68	DMX104M	10.4	●	10.4	66	46	112
DMX047M	4.7	●	4.7	32	36	68	DMX105M	10.5	●	10.5	66	46	112
DMX048M	4.8	●	4.8	32	36	68	DMX106M	10.6	●	10.6	68	46	114
DMX049M	4.9	●	4.9	32	36	68	DMX107M	10.7	●	10.7	68	46	114
DMX050M	5	●	5	32	36	68	DMX108M	10.8	●	10.8	68	46	114
DMX051M	5.1	●	5.1	34	38	72	DMX109M	10.9	●	10.9	68	46	114
DMX052M	5.2	●	5.2	34	38	72	DMX110M	11	●	11	68	46	114
DMX053M	5.3	●	5.3	34	38	72	DMX111M	11.1	●	11.1	71	47	118
DMX054M	5.4	●	5.4	34	38	72	DMX112M	11.2	●	11.2	71	47	118
DMX055M	5.5	●	5.5	34	38	72	DMX113M	11.3	●	11.3	71	47	118
DMX056M	5.6	●	5.6	36	38	74	DMX114M	11.4	●	11.4	71	47	118
DMX057M	5.7	●	5.7	36	38	74	DMX115M	11.5	●	11.5	71	47	118
DMX058M	5.8	●	5.8	36	38	74	DMX116M	11.6	●	11.6	73	48	121
DMX059M	5.9	●	5.9	36	38	74	DMX117M	11.7	●	11.7	73	48	121
DMX060M	6	●	6	41	40	81	DMX118M	11.8	●	11.8	73	48	121
DMX061M	6.1	●	6.1	41	40	81	DMX119M	11.9	●	11.9	73	48	121
DMX062M	6.2	●	6.2	41	40	81	DMX120M	12	●	12	73	48	121
DMX063M	6.3	●	6.3	41	40	81	DMX121M	12.1	●	12.1	76	59	135
DMX064M	6.4	●	6.4	41	40	81	DMX122M	12.2	●	12.2	76	59	135
DMX065M	6.5	●	6.5	41	40	81	DMX123M	12.3	●	12.3	76	59	135
DMX066M	6.6	●	6.6	43	40	83	DMX124M	12.4	●	12.4	76	59	135
DMX067M	6.7	●	6.7	43	40	83	DMX125M	12.5	●	12.5	76	59	135
DMX068M	6.8	●	6.8	43	40	83	DMX126M	12.6	●	12.6	78	59	137
DMX069M	6.9	●	6.9	43	40	83	DMX127M	12.7	●	12.7	78	59	137
DMX070M	7	●	7	43	40	83	DMX128M	12.8	●	12.8	78	59	137
DMX071M	7.1	●	7.1	45	42	87	DMX129M	12.9	●	12.9	78	59	137
DMX072M	7.2	●	7.2	45	42	87	DMX130M	13	●	13	78	59	137
DMX073M	7.3	●	7.3	45	42	87	DMX131M	13.1	●	13.1	84	60	144
DMX074M	7.4	●	7.4	45	42	87	DMX132M	13.2	●	13.2	84	60	144
DMX075M	7.5	●	7.5	45	42	87	DMX133M	13.3	●	13.3	84	60	144
DMX076M	7.6	●	7.6	48	42	90	DMX134M	13.4	●	13.4	84	60	144
DMX077M	7.7	●	7.7	48	42	90	DMX135M	13.5	●	13.5	84	60	144
DMX078M	7.8	●	7.8	48	42	90	DMX136M	13.6	●	13.6	86	61	147
DMX079M	7.9	●	7.9	48	42	90	DMX137M	13.7	●	13.7	86	61	147
DMX080M	8	●	8	48	42	90	DMX138M	13.8	●	13.8	86	61	147
DMX081M	8.1	●	8.1	53	43	96	DMX139M	13.9	●	13.9	86	61	147
DMX082M	8.2	●	8.2	53	43	96	DMX140M	14	●	14	86	61	147
DMX083M	8.3	●	8.3	53	43	96	DMX141M	14.1	●	14.1	89	62	151
DMX084M	8.4	●	8.4	53	43	96	DMX142M	14.2	●	14.2	89	62	151
DMX085M	8.5	●	8.5	53	43	96	DMX143M	14.3	●	14.3	89	62	151
DMX086M	8.6	●	8.6	55	43	98	DMX144M	14.4	●	14.4	89	62	151
DMX087M	8.7	●	8.7	55	43	98	DMX145M	14.5	●	14.5	89	62	151

● : Line up



Metric	ϕD_c	AH170	ϕD_s	ℓ	ℓ_s	L	Metric	ϕD_c	AH170	ϕD_s	ℓ	ℓ_s	L
DMX146M	14.6	●	14.6	91	62	153	DMX158M	15.8	●	15.8	96	64	160
DMX147M	14.7	●	14.7	91	62	153	DMX159M	15.9	●	15.9	96	64	160
DMX148M	14.8	●	14.8	91	62	153	DMX160M	16	●	16	96	64	160
DMX149M	14.9	●	14.9	91	62	153	DMX165M	16.5	●	16.5	102	65	167
DMX150M	15	●	15	91	62	153	DMX170M	17	●	17	102	65	167
DMX151M	15.1	●	15.1	94	63	157	DMX175M	17.5	●	17.5	102	65	167
DMX152M	15.2	●	15.2	94	63	157	DMX180M	18	●	18	102	65	167
DMX153M	15.3	●	15.3	94	63	157	DMX185M	18.5	●	18.5	114	65	179
DMX154M	15.4	●	15.4	94	63	157	DMX190M	19	●	19	114	65	179
DMX155M	15.5	●	15.5	94	63	157	DMX195M	19.5	●	19.5	114	65	179
DMX156M	15.6	●	15.6	96	64	160	DMX200M	20	●	20	114	65	179
DMX157M	15.7	●	15.7	96	64	160							

- Cutting fluid should be sufficiently supplied to the drill point and the entrance of the hole.
- Use a water-soluble cutting fluid.

● : Line up

STANDARD CUTTING CONDITIONS

ISO	Workpiece material	Examples (JIS)	Hardness	Cutting speed Vc (sfm)	Feed: f (ipr)			
					$\phi 0.118 \sim \phi 0.197$	$\phi 0.197 \sim \phi 0.394$	$\phi 0.394 \sim \phi 0.630$	$\phi 0.630 \sim \phi 0.787$
P	Mild steels · Low Carbon steels	1018, etc.	< 180HB	131 - 262	0.006 - 0.010	0.006 - 0.012	0.008 - 0.016	0.010 - 0.020
	Carbon steels · Alloy steels	1045, etc.	180 ~ 300HB	131 - 262	0.006 - 0.010	0.006 - 0.012	0.008 - 0.016	0.010 - 0.020
	High alloy steels, etc.	4140, etc.	250 ~ 350HB	131 - 230	0.004 - 0.008	0.006 - 0.010	0.006 - 0.012	0.008 - 0.016
M	Stainless steels	304SS, etc.	< 200HB	66 - 131	0.002 - 0.008	0.004 - 0.010	0.004 - 0.012	0.006 - 0.012
K	Gray cast irons	Class 25, etc.	< 300HB	131 - 262	0.006 - 0.014	0.010 - 0.018	0.012 - 0.024	0.014 - 0.026
	Ductile cast irons	60-40-18, etc.	< 300HB	131 - 262	0.006 - 0.012	0.008 - 0.016	0.010 - 0.020	0.012 - 0.024
S	Titanium alloys	Ti-6Al-4V, etc.		66 - 131	0.004 - 0.008	0.006 - 0.010	0.006 - 0.012	0.008 - 0.016
	Heat-resistant alloys	Inconel 718, etc.	250HB <	33 - 98	0.001 - 0.003	0.002 - 0.004	0.003 - 0.005	0.003 - 0.005
H	Hardened material		< 45HRC	33 - 98	0.001 - 0.003	0.002 - 0.004	0.003 - 0.005	0.003 - 0.005

Note:

- Because the cutting conditions may be changed depending on the material type, hardness, machinability, machine tool, and coolant, the most appropriate conditions must be decided whilst referring the chip control condition and tool failure mode.
- When using the smaller side of the diameter range, the feed rate should be set lower.
- When drilling difficult-to-cut materials, coolant supplying conditions are critical for successful drilling. So, the use of constant and flood coolant is highly recommended.
- For the standard DMX-type drills, somewhat large honing width intended for drilling of general steels is applied. But, when drilling difficult-to-cut materials having high hardness, requiring lowering the feed rate, the honing width should be modified.
- The drills with special honing specification are made to order on request.
- Inconel is trademark of Huntington Alloys, Inc.

**FDS**

Straight flute solid drill for pre-tap hole drilling of aluminum, without oil hole

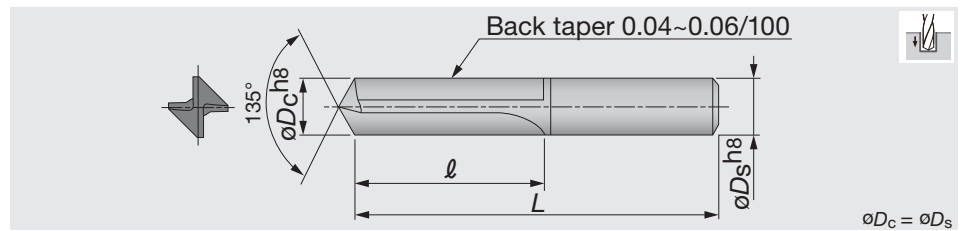
■ **L/D = 2 (S type)**■ **For tapped holes**

Metric	ϕD_c	Tolerance	G1F	ℓ	L	Application
FDS0257	2.57	$\begin{matrix} 0 \\ -0.014 \end{matrix}$	●	18	60	M3
FDS0337	3.37	$\begin{matrix} 0 \\ -0.018 \end{matrix}$	●	18	60	M4
FDS0429	4.29	$\begin{matrix} 0 \\ -0.018 \end{matrix}$	●	23	70	M5
FDS0511	5.11	$\begin{matrix} 0 \\ -0.018 \end{matrix}$	●	28	80	M6
FDS0683	6.83	$\begin{matrix} 0 \\ -0.022 \end{matrix}$	●	36	90	M8
FDS0860	8.6	$\begin{matrix} 0 \\ -0.022 \end{matrix}$	●	46	110	M10

■ **For bolt holes**

Metric	ϕD_c	Tolerance	G1F	ℓ	L	Application
FDS0340	3.4	$\begin{matrix} 0 \\ -0.018 \end{matrix}$	●	18	60	M3
FDS0450	4.5	$\begin{matrix} 0 \\ -0.018 \end{matrix}$	●	23	70	M4
FDS0550	5.5	$\begin{matrix} 0 \\ -0.018 \end{matrix}$		28	80	M5
FDS0660	6.6	$\begin{matrix} 0 \\ -0.022 \end{matrix}$	●	36	90	M6
FDS0900	9	$\begin{matrix} 0 \\ -0.022 \end{matrix}$		46	110	M8
FDS1100	11	$\begin{matrix} 0 \\ -0.027 \end{matrix}$	●	55	120	M10

● : Line up

Notes: ● Other sized drills and step type drills can be made to order.

● When ordering, specify the diameter, overall length, shank specifications of the drill, the work material to be drilled, and the drilling depth.

Reference pages

Standard cutting conditions → **E061**

APPLICATION EXAMPLES OF FD DRILLS (EFFECTIVE FOR FOLLOWING OPERATIONS)

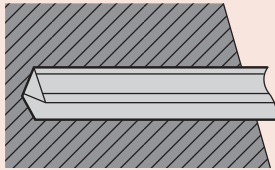

Drilling into angled face

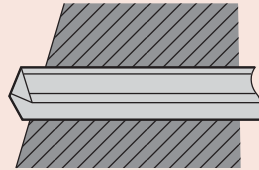

Drilling through angled face

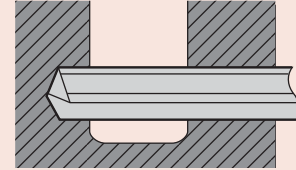

Interrupted drilling



2-effective Drill

STANDARD CUTTING CONDIOTIONS

ISO	Workpiece material	Cutting speed: Vc (sfm)	Feed: f (ipr)
N	Aluminum alloys (Brittle)	164 - 262	0.004 - 0.012
	Aluminum alloys (Sticky)	131 - 197	0.004 - 0.008
K	Gray cast irons	131 - 197	0.004 - 0.012
	Ductile cast irons	98 - 164	0.003 - 0.008

Note : Use a water soluble emulsion type cutting fluid.
Excessive run out as mounted on the machine may affect drilled hole accuracies and tool life.
(Holding with a scroll chuck is not recommended.)

- No. of revolutions (min^{-1}) = Cutting speed \times 1000 \div 3.14 \div Tool diameter
- Table feed (mm/min) = No. of revolutions \times Feed per revolution



FDCU

Straight flute solid drill for high feed drilling of aluminum and cast iron, with oil hole

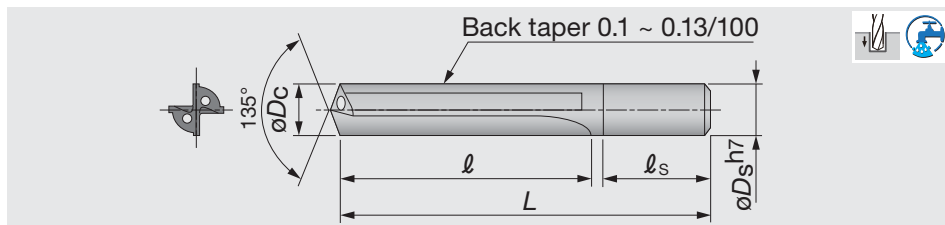

L/D = 5 (S type)

Inch	ϕD_c	G1F	ϕD_s	ℓ	ℓ_s	L
FDCU203S	0.2031	●	0.2362	1.73	1.57	3.35
FDCU218S	0.2188	●	0.2362	1.89	1.57	3.54
FDCU234S	0.2344	●	0.2362	1.89	1.57	3.54
FDCU250S	0.2500	●	0.2756	2.05	1.57	3.74
FDCU265S	0.2656	●	0.2756	2.20	1.57	3.94
FDCU281S	0.2813	●	0.3150	2.36	1.65	4.13
FDCU296S	0.2969	●	0.3150	2.52	1.65	4.33
FDCU312S	0.3125	●	0.3150	2.52	1.65	4.33
FDCU328S	0.3281	●	0.3543	2.68	1.73	4.53
FDCU343S	0.3438	●	0.3543	2.83	1.73	4.72
FDCU359S	0.3594	●	0.3937	2.99	1.73	4.92
FDCU375S	0.3750	●	0.3937	3.15	1.81	5.12
FDCU390S	0.3906	●	0.3937	3.15	1.81	5.12
FDCU406S	0.4063	●	0.4331	3.31	1.81	5.51
FDCU421S	0.4219	●	0.4331	3.46	1.81	5.51
FDCU437S	0.4375	●	0.4724	3.62	1.89	5.91
FDCU453S	0.4531	●	0.4724	3.78	1.89	5.91
FDCU468S	0.4688	●	0.4724	3.78	1.89	5.91
FDCU484S	0.4844	●	0.5118	3.94	1.97	6.30
FDCU500S	0.5000	●	0.5118	4.09	1.97	6.30
FDCU515S	0.5156	●	0.5512	4.25	2.05	6.69
FDCU531S	0.5313	●	0.5512	4.25	2.05	6.69
FDCU546S	0.5469	●	0.5512	4.41	2.05	6.69
FDCU562S	0.5625	●	0.5906	4.57	2.13	7.09
FDCU578S	0.5781	●	0.5906	4.72	2.13	7.09
FDCU593S	0.5937	●	0.6299	4.88	2.20	7.48
FDCU609S	0.6093	●	0.6299	4.88	2.20	7.48
FDCU625S	0.6250	●	0.6299	5.04	2.20	7.48

ϕD_c	Tool diameter tolerance	● : Line up
$0.2031 \leq \phi D_c \leq 0.2344$	+0.0008 ~ +0.0004	
$0.2344 < \phi D_c \leq 0.6250$	+0.0010 ~ +0.0006	

L/D = 8 (L type)

Inch	ϕD_c	G1F	ϕD_s	ℓ	ℓ_s	L
FDCU203L	0.2031	●	0.2362	2.40	1.57	4.13
FDCU218L	0.2188	●	0.2362	2.60	1.57	4.33
FDCU234L	0.2344	●	0.2362	2.60	1.57	4.33
FDCU250L	0.2500	●	0.2756	2.83	1.57	4.53
FDCU265L	0.2656	●	0.2756	3.03	1.57	4.72
FDCU281L	0.2813	●	0.3150	3.27	1.65	4.92
FDCU296L	0.2969	●	0.3150	3.46	1.65	5.12
FDCU312L	0.3125	●	0.3150	3.46	1.65	5.12
FDCU328L	0.3281	●	0.3543	3.70	1.73	5.51
FDCU343L	0.3438	●	0.3543	3.90	1.73	5.71
FDCU359L	0.3594	●	0.3937	4.13	1.73	5.91
FDCU375L	0.3750	●	0.3937	4.33	1.81	6.30
FDCU390L	0.3906	●	0.3937	4.33	1.81	6.30

ϕD_c	Tool diameter tolerance	● : Line up
$0.2031 \leq \phi D_c \leq 0.2344$	+0.0008 ~ +0.0004	
$0.2344 < \phi D_c \leq 0.3906$	+0.0010 ~ +0.0006	

Reference pages

Standard cutting conditions → E065



FDC

Straight flute solid drill for high feed drilling of aluminum and cast iron, with oil hole

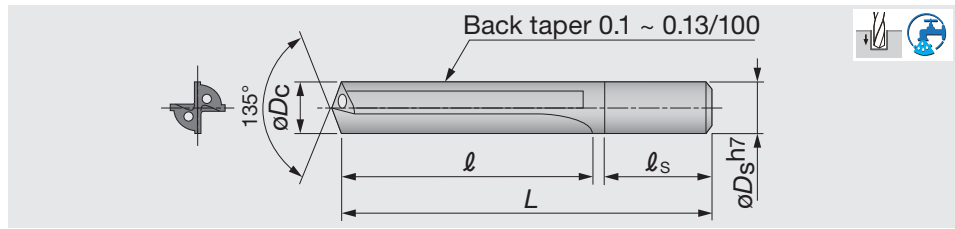

L/D = 5 (S type)

Metric	ϕD_c	G1F	ϕD_s	ℓ	ℓ_s	L	Metric	ϕD_c	G1F	ϕD_s	ℓ	ℓ_s	L
FDC0500S	5		5	40	38	80	FDC0940S	9.4		10	76	44	125
FDC0510S	5.1	●	6	44	40	85	FDC0950S	9.5		10	76	44	125
FDC0520S	5.2		6	44	40	85	FDC0960S	9.6		10	80	46	130
FDC0530S	5.3		6	44	40	85	FDC0970S	9.7		10	80	46	130
FDC0540S	5.4		6	44	40	85	FDC0980S	9.8		10	80	46	130
FDC0550S	5.5		6	44	40	85	FDC0990S	9.9		10	80	46	130
FDC0560S	5.6		6	48	40	90	FDC1000S	10		10	80	46	130
FDC0570S	5.7		6	48	40	90	FDC1050S	10.5	●	11	84	46	140
FDC0580S	5.8		6	48	40	90	FDC1100S	11	●	11	88	46	140
FDC0590S	5.9		6	48	40	90	FDC1150S	11.5	●	12	92	48	150
FDC0600S	6	●	6	48	40	90	FDC1200S	12	●	12	96	48	150
FDC0610S	6.1		7	52	40	95	FDC1250S	12.5	●	13	100	50	160
FDC0620S	6.2		7	52	40	95	FDC1300S	13	●	13	104	50	160
FDC0630S	6.3		7	52	40	95	FDC1350S	13.5	●	14	108	52	170
FDC0640S	6.4		7	52	40	95	FDC1400S	14	●	14	112	52	170
FDC0650S	6.5		7	52	40	95	FDC1450S	14.5	●	15	116	54	180
FDC0660S	6.6		7	56	40	100	FDC1500S	15	●	15	120	54	180
FDC0670S	6.7		7	56	40	100	FDC1550S	15.5	●	16	124	56	190
FDC0680S	6.8		7	56	40	100	FDC1600S	16	●	16	128	56	190
FDC0690S	6.9		7	56	40	100							
FDC0700S	7		7	56	40	100							
FDC0710S	7.1		8	60	42	105							
FDC0720S	7.2		8	60	42	105							
FDC0730S	7.3		8	60	42	105							
FDC0740S	7.4		8	60	42	105							
FDC0750S	7.5		8	60	42	105							
FDC0760S	7.6		8	64	42	110							
FDC0770S	7.7		8	64	42	110							
FDC0780S	7.8		8	64	42	110							
FDC0790S	7.9		8	64	42	110							
FDC0800S	8		8	64	42	110							
FDC0810S	8.1		9	68	44	115							
FDC0820S	8.2		9	68	44	115							
FDC0830S	8.3		9	68	44	115							
FDC0840S	8.4	●	9	68	44	115							
FDC0850S	8.5		9	68	44	115							
FDC0860S	8.6	●	9	72	44	120							
FDC0870S	8.7		9	72	44	120							
FDC0880S	8.8		9	72	44	120							
FDC0890S	8.9		9	72	44	120							
FDC0900S	9		9	72	44	120							
FDC0910S	9.1		10	76	44	125							
FDC0920S	9.2		10	76	44	125							
FDC0930S	9.3		10	76	44	125							

ϕD_c	Tool diameter tolerance(mm)
$5 \leq \phi D_c \leq 6$	+0.02 ~ +0.01
$6 < \phi D_c \leq 16$	+0.025 ~ +0.015

● : Line up

Reference pages

Standard cutting conditions → E065



FDC

■ L/D = 8 (L type)

Metric	ϕD_c	G1F	ϕD_s	ℓ	ℓ_s	L	Metric	ϕD_c	G1F	ϕD_s	ℓ	ℓ_s	L
FDC0500L	5	●	5	55	38	95	FDC0760L	7.6		8	88	42	130
FDC0510L	5.1		6	61	40	105	FDC0770L	7.7		8	88	42	130
FDC0520L	5.2		6	61	40	105	FDC0780L	7.8	●	8	88	42	130
FDC0530L	5.3		6	61	40	105	FDC0790L	7.9		8	88	42	130
FDC0540L	5.4		6	61	40	105	FDC0800L	8	●	8	88	42	130
FDC0550L	5.5	●	6	61	40	105	FDC0810L	8.1		9	94	44	140
FDC0560L	5.6		6	66	40	110	FDC0820L	8.2		9	94	44	140
FDC0570L	5.7		6	66	40	110	FDC0830L	8.3		9	94	44	140
FDC0580L	5.8		6	66	40	110	FDC0840L	8.4		9	94	44	140
FDC0590L	5.9		6	66	40	110	FDC0850L	8.5	●	9	94	44	140
FDC0600L	6	●	6	66	40	110	FDC0860L	8.6	●	9	99	44	145
FDC0610L	6.1		7	72	40	115	FDC0870L	8.7		9	99	44	145
FDC0620L	6.2	●	7	72	40	115	FDC0880L	8.8		9	99	44	145
FDC0630L	6.3		7	72	40	115	FDC0890L	8.9		9	99	44	145
FDC0640L	6.4		7	72	40	115	FDC0900L	9	●	9	99	44	145
FDC0650L	6.5	●	7	72	40	115	FDC0910L	9.1		10	105	44	150
FDC0660L	6.6		7	77	40	120	FDC0920L	9.2		10	105	44	150
FDC0670L	6.7		7	77	40	120	FDC0930L	9.3		10	105	44	150
FDC0680L	6.8	●	7	77	40	120	FDC0940L	9.4		10	105	44	150
FDC0690L	6.9		7	77	40	120	FDC0950L	9.5	●	10	105	44	150
FDC0700L	7	●	7	77	40	120	FDC0960L	9.6		10	110	46	160
FDC0710L	7.1		8	83	42	125	FDC0970L	9.7		10	110	46	160
FDC0720L	7.2		8	83	42	125	FDC0980L	9.8		10	110	46	160
FDC0730L	7.3		8	83	42	125	FDC0990L	9.9		10	110	46	160
FDC0740L	7.4		8	83	42	125	FDC1000L	10	●	10	110	46	160
FDC0750L	7.5	●	8	83	42	125							

● : Line up

ϕD_c	Tool diameter tolerance (mm)
$5 \leq \phi D_c \leq 6$	+0.02 ~ +0.01
$6 < \phi D_c \leq 10$	+0.025 ~ +0.015

Reference pages

Standard cutting conditions → E065



Cutting fluid

- Supply the cutting fluid through the drill.
- The required fluid pressure is 75 - 150 psi.
- Use a water-soluble cutting fluid containing a large amount of extreme-pressure additive.

Coolant Supply Adapters

- As the FD-Jet drill requires a chuck holder capable of internal coolant supplying, use the coolany supply adapter.
- In the case of a rotating type tool, use either the coolant supply adapter in combination with a commercially available rotatable coolant supply holder, or a rotatable coolant supply holder with a collect chuck.

STANDARD CUTTING CONDITIONS

ISO	Workpiece material	Cutting speed: V_c (SFM)			Feed: f (in/rev)		
		$\phi 0.1969 - \phi 0.3150$	$\phi 0.3150 - \phi 0.4724$	$\phi 0.4724 - \phi 0.6300$	$\phi 0.1969 - \phi 0.3150$	$\phi 0.3150 - \phi 0.4724$	$\phi 0.4724 - \phi 0.6300$
N	Aluminum alloys	330 - 460	390 - 520	460 - 590	0.004 - 0.010	0.006 - 0.012	0.006 - 0.012
K	Gray cast iron	300 - 390	360 - 460	430 - 520	0.004 - 0.010	0.006 - 0.012	0.008 - 0.012
	Ductile cast irons	200 - 260	230 - 300	230 - 330	0.004 - 0.010	0.006 - 0.012	0.006 - 0.012

Caution:

When changing a tool, completely clean the chips which may be clogging in the collet or adapter.

Note:





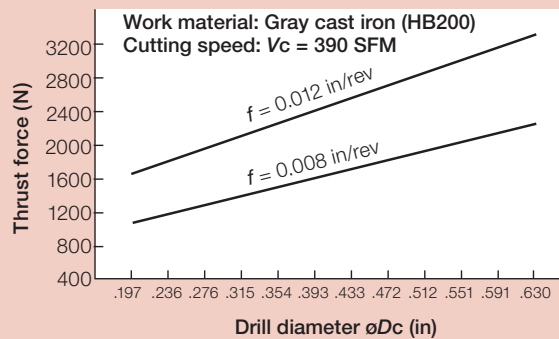
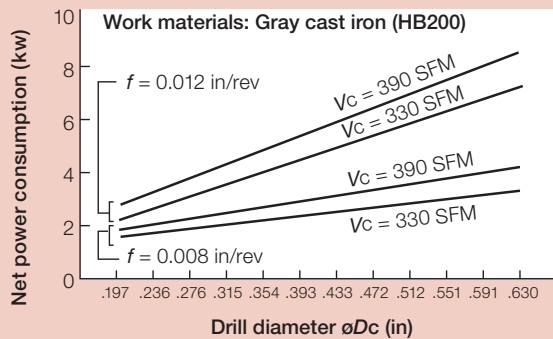

The cutting conditions shown left may vary depending on the work material, coolant dilution ratio and coolant supply pressure used.

CUTTING PERFORMANCE



- No. of revolutions (min^{-1}) = Cutting speed \times 1000 \div 3.14 \div Tool diameter
- Table feed (mm/min) = No. of revolutions \times Feed per revolution

DrillLine - Indexable Drill

				Inch	Metric
	TUNGSIX-DRILL Indexable drill with 6-cutting-edged insert for high productivity  $\phi 0.812'' - \phi 2.000'' / L/D = 2, 3, 4$	<u>E068</u>	<input checked="" type="checkbox"/>	<input type="checkbox"/>	
	TUNGDRILLTWISTED Indexable drills with 4-cornered inserts for various drilling applications  $\phi 0.500'' - \phi 2.125'' / L/D = 2, 3, 4, 5$	<u>E076</u>	<input checked="" type="checkbox"/>	<input type="checkbox"/>	
	TUNGDRILLBIG Large-diameter drills with cartridges applicable for both the TungSix-Drill or TungDrill-Twisted inserts  $\phi 2.250'' - \phi 3.157'' / L/D = 2.5$	<u>E088</u>	<input checked="" type="checkbox"/>	<input type="checkbox"/>	



TungSix-Drill

Tungaloy E067

TUNGSIX-DRILL

TDSU-F L/D=2 (Flat)

L/D = 2, Flat, Tool dia. $\phi 0.812'' - \phi 1.062''$



Indexable Drill

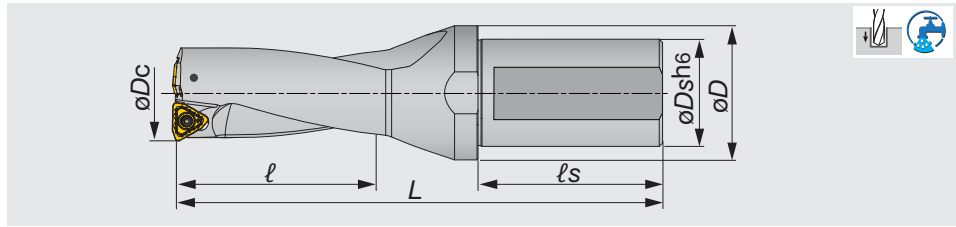

Inch	ϕD_c	ϕD_s	ϕD	ℓ	ℓ_s	L	Max. offset** (radial)	lb	Insert
TDSU0812F-2	0.812	1.000	1.457	1.625	2.205	4.665	0.031	0.7	WWMU05X205R-D*
TDSU0875F-2	0.875	1.000	1.457	1.75	2.205	4.831	0.020	0.7	WWMU05X205R-D*
TDSU0937F-2	0.937	1.000	1.457	1.875	2.205	4.994	0.047	0.9	WWMU060306R-D*
TDSU1000F-2	1.000	1.000	1.457	2.000	2.205	5.161	0.026	0.9	WWMU060306R-D*
TDSU1062F-2	1.062	1.250	1.575	2.125	2.342	5.465	0.012	1.3	WWMU060306R-D*

Machined hole diameter may change depending upon the rigidity of the machine tool or cutting conditions.

** For offsetting on lathe

Tool diameter	Tool diameter tolerance	Hole diameter tolerance*
$\phi 0.812 - \phi 1.063$	+ 0.008 / 0	+ 0.010 / 0

*Just for reference

SPARE PARTS

Designation	Clamping screw	Wrench
TDSU0812... - TDSU0875...	CSPB-2.2	IP-7D
TDSU0937... - TDSU1062...	CSPB-2.5	IP-8D

TDSU L/D=2 (Whistle notch)

L/D = 2, Whistle notch, Tool dia. $\phi 1.125'' - \phi 2.000''$

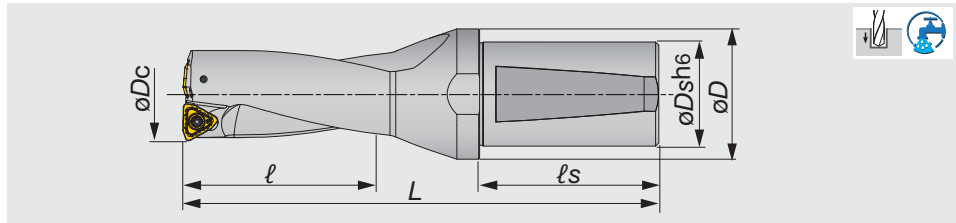

Inch	ϕD_c	ϕD_s	ϕD	ℓ	ℓ_s	L	Max. offset** (radial)	lb	Insert
TDSU1125-02	1.125	1.250	1.575	2.250	2.280	5.892	0.043	1.5	WWMU08X408R-**
TDSU1187-02	1.187	1.250	1.575	2.374	2.280	6.079	0.019	1.6	WWMU08X408R-**
TDSU1250-02	1.250	1.250	1.575	2.500	2.280	6.267	0.008	1.7	WWMU08X408R-**
TDSU1312-02	1.312	1.500	1.969	2.624	2.688	6.862	0.055	2.5	WWMU09X510R-**
TDSU1375-02	1.375	1.500	1.969	2.750	2.688	7.049	0.047	2.6	WWMU09X510R-**
TDSU1437-02	1.437	1.500	1.969	2.874	2.688	7.237	0.027	2.8	WWMU09X510R-**
TDSU1500-02	1.500	1.500	1.969	3.000	2.688	7.424	0.015	2.9	WWMU09X510R-**
TDSU1562-02	1.562	1.500	1.969	3.124	2.688	7.612	0.074	3.0	WWMU11X512R-**
TDSU1625-02	1.625	1.500	2.165	3.250	2.688	7.799	0.059	3.3	WWMU11X512R-**
TDSU1687-02	1.687	1.500	2.165	3.374	2.688	7.987	0.051	3.5	WWMU11X512R-**
TDSU1750-02	1.750	1.500	2.165	3.500	2.688	8.174	0.027	3.7	WWMU11X512R-**
TDSU1812-02	1.812	1.500	2.165	3.624	2.688	8.362	0.015	3.9	WWMU11X512R-**
TDSU1875-02	1.875	1.500	2.165	3.750	2.688	8.549	0.094	4.2	WWMU13X512R-**
TDSU1937-02	1.937	1.500	2.165	3.874	2.688	8.737	0.078	4.3	WWMU13X512R-**
TDSU2000-02	2.000	1.500	2.165	4.000	2.688	8.924	0.067	4.6	WWMU13X512R-**

Machined hole diameter may change depending upon the rigidity of the machine tool or cutting conditions.

** For offsetting on lathe

Tool diameter	Tool diameter tolerance	Hole diameter tolerance*
$\phi 1.125 - \phi 2.000$	+ 0.004	+ 0.008 / -0.004

*Just for reference

SPARE PARTS

Designation	Clamping screw	Wrench
TDSU1125... - TDSU1250...	CSTB-3	T-9D
TDSU1312... - TDSU1500...	CSTB-4	T-15D
TDSU1562... - TDSU2000...	CSTB-5	T-20D

Reference pages

Inserts → E071, Standard cutting conditions → E072 - E073

TUNGSIX-DRILL

TDSU-F L/D=3 (Flat)

L/D = 3, Flat, Tool dia. $\phi 0.812'' - \phi 1.062''$

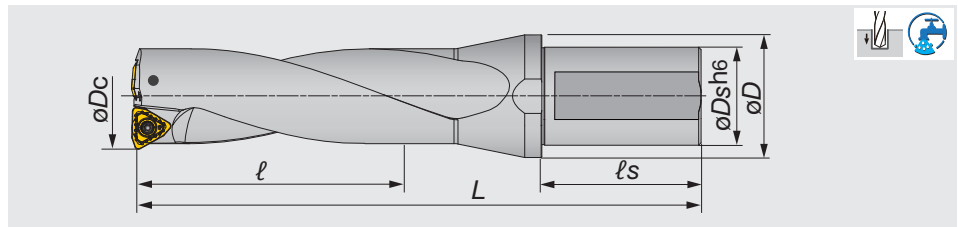

Inch	ϕD_c	ϕD_s	ϕD	ℓ	ℓ_s	L	Max. offset** (radial)	lb	Insert
TDSU0812F-3	0.812	1.000	1.457	2.438	2.205	5.516	0.031	0.7	WWMU05X205R-D*
TDSU0875F-3	0.875	1.000	1.457	2.625	2.205	5.665	0.020	0.9	WWMU05X205R-D*
TDSU0937F-3	0.937	1.000	1.457	2.813	2.205	5.894	0.047	0.9	WWMU060306R-D*
TDSU1000F-3	1.000	1.000	1.457	3.000	2.205	6.122	0.028	1.1	WWMU060306R-D*
TDSU1062F-3	1.062	1.250	1.575	3.186	2.342	6.488	0.012	1.3	WWMU060306R-D*

Machined hole diameter may change depending upon the rigidity of the machine tool or cutting conditions.

** For offsetting on lathe

Tool diameter	Tool diameter tolerance	Hole diameter tolerance*
$\phi 0.812 - \phi 1.063$	+ 0.008 / 0	+ 0.010 / 0

*Just for reference

SPARE PARTS

Designation	Clamping screw	Wrench
TDSU0812... - TDSU0875...	CSPB-2.2	IP-7D
TDSU0937... - TDSU1062...	CSPB-2.5	IP-8D

TDSU L/D=3 (Whistle notch)

L/D = 3, Whistle notch, Tool dia. $\phi 1.125'' - \phi 2.000''$

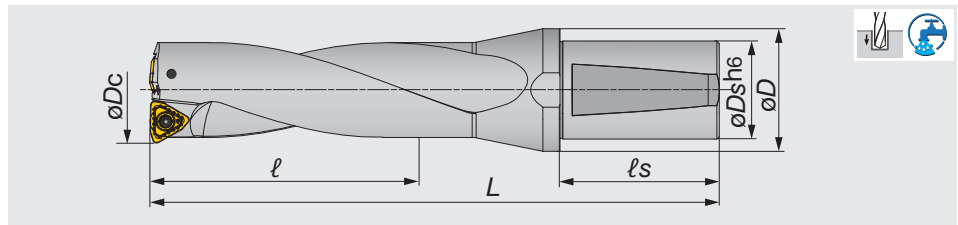

Inch	ϕD_c	ϕD_s	ϕD	ℓ	ℓ_s	L	Max. offset** (radial)	lb	Insert
TDSU1125-03	1.125	1.250	1.575	3.375	2.280	7.017	0.043	1.7	WWMU08X408R-**
TDSU1187-03	1.187	1.250	1.575	3.561	2.280	7.267	0.019	1.8	WWMU08X408R-**
TDSU1250-03	1.250	1.250	1.575	3.750	2.280	7.517	0.008	1.9	WWMU08X408R-**
TDSU1312-03	1.312	1.500	1.969	3.936	2.688	8.174	0.055	2.8	WWMU09X510R-**
TDSU1375-03	1.375	1.500	1.969	4.125	2.688	8.424	0.047	2.9	WWMU09X510R-**
TDSU1437-03	1.437	1.500	1.969	4.311	2.688	8.674	0.027	3.1	WWMU09X510R-**
TDSU1500-03	1.500	1.500	1.969	4.500	2.688	8.924	0.015	3.3	WWMU09X510R-**
TDSU1562-03	1.562	1.500	1.969	4.686	2.688	9.174	0.074	3.4	WWMU11X512R-**
TDSU1625-03	1.625	1.500	2.165	4.875	2.688	9.424	0.059	3.8	WWMU11X512R-**
TDSU1687-03	1.687	1.500	2.165	5.061	2.688	9.674	0.051	4.1	WWMU11X512R-**
TDSU1750-03	1.750	1.500	2.165	5.250	2.688	9.924	0.027	4.3	WWMU11X512R-**
TDSU1812-03	1.812	1.500	2.165	5.436	2.688	10.174	0.015	4.6	WWMU11X512R-**
TDSU1875-03	1.875	1.500	2.165	5.625	2.688	10.424	0.094	4.9	WWMU13X512R-**
TDSU1937-03	1.937	1.500	2.165	5.811	2.688	10.674	0.078	5.1	WWMU13X512R-**
TDSU2000-03	2.000	1.500	2.165	6.000	2.688	10.924	0.067	5.5	WWMU13X512R-**

Machined hole diameter may change depending upon the rigidity of the machine tool or cutting conditions.

** For offsetting on lathe

Tool diameter	Tool diameter tolerance	Hole diameter tolerance*
$\phi 1.125 - \phi 2.000$	+ 0.004	+ 0.008 / -0.004

*Just for reference

SPARE PARTS

Designation	Clamping screw	Wrench
TDSU1125... - TDSU1250...	CSTB-3	T-9D
TDSU1312... - TDSU1500...	CSTB-4	T-15D
TDSU1562... - TDSU2000...	CSTB-5	T-20D

Reference pages

Inserts → E071, Standard cutting conditions → E072 - E073

Indexable Drill

TUNGSIX-DRILL

TDSU-F L/D=4 (Flat)

L/D = 4, Flat, Tool dia. $\phi 1.125'' - \phi 2.000''$



Indexable Drill

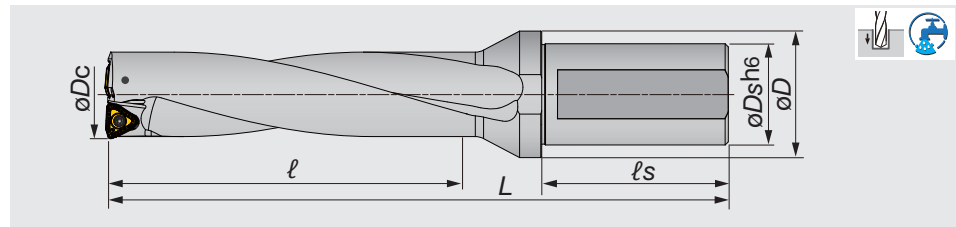

Inch	ϕD_c	ϕD_s	ϕD	ℓ	ℓ_s	L	Max. offset** (radial)	lb	Insert
TDSU0812F-4	0.813	1.000	1.457	3.250	2.343	6.457	0.031	0.88	WWMU05X205R-D*
TDSU0875F-4	0.875	1.000	1.457	3.500	2.343	6.669	0.016	0.88	WWMU05X205R-D*
TDSU0937F-4	0.938	1.000	1.457	3.750	2.343	6.969	0.047	1.1	WWMU060306R-D*
TDSU1000F-4	1.000	1.000	1.457	4.000	2.343	7.260	0.024	1.1	WWMU060306R-D*
TDSU1062F-4	1.063	1.250	1.575	4.250	2.343	7.551	0.012	1.54	WWMU060306R-D*
TDSU1125F-4	1.125	1.250	1.575	4.500	2.343	7.897	0.043	1.7	WWMU08X408R-D*
TDSU1187F-4	1.187	1.250	1.575	4.748	2.343	8.179	0.019	1.9	WWMU08X408R-D*
TDSU1250F-4	1.250	1.250	1.575	5.000	2.343	8.470	0.008	2.0	WWMU08X408R-D*
TDSU1312F-4	1.312	1.500	1.969	5.248	2.736	9.161	0.055	2.9	WWMU09X510R-D*
TDSU1375F-4	1.375	1.500	1.969	5.500	2.736	9.452	0.047	3.1	WWMU09X510R-D*
TDSU1437F-4	1.437	1.500	1.969	5.748	2.736	9.744	0.027	3.2	WWMU09X510R-D*
TDSU1500F-4	1.500	1.500	1.969	6.000	2.736	10.034	0.015	3.5	WWMU09X510R-D*
TDSU1625F-4	1.625	1.500	2.165	6.500	2.736	10.643	0.059	4.0	WWMU11X512R-D*
TDSU1687F-4	1.687	1.500	2.165	6.748	2.736	10.934	0.051	4.5	WWMU11X512R-D*
TDSU1750F-4	1.750	1.500	2.165	7.000	2.736	11.226	0.027	5.1	WWMU11X512R-D*
TDSU1812F-4	1.812	1.500	2.165	7.248	2.736	11.517	0.015	5.3	WWMU11X512R-D*
TDSU1875F-4	1.875	1.500	2.165	7.500	2.736	11.815	0.094	5.4	WWMU13X512R-D*
TDSU1937F-4	1.937	1.500	2.165	7.748	2.736	12.036	0.078	5.5	WWMU13X512R-D*
TDSU2000F-4	2.000	1.500	2.165	8.000	2.736	12.327	0.067	5.6	WWMU13X512R-D*

Machined hole diameter may change depending upon the rigidity of the machine tool or cutting conditions.

** For offsetting on lathe

Tool diameter	Tool diameter tolerance	Hole diameter tolerance*
$\phi 0.813 - \phi 2.000$	+ 0.008 / 0	+ 0.014 / 0

*Just for reference

SPARE PARTS

Designation	Clamping screw	Wrench
TDSU0812... - TDSU0875...	CSPB-2.2	IP-7D
TDSU0937... - TDSU1062...	CSPB-2.5	IP-8D
TDSU1125... - TDSU1250...	CSTB-3	T-9D
TDSU1312... - TDSU1500...	CSTB-4	T-15D
TDSU1562... - TDSU2000...	CSTB-5	T-20D

Reference pages

Inserts → E071, Standard cutting conditions → E072 - E073

INSERT

DJ

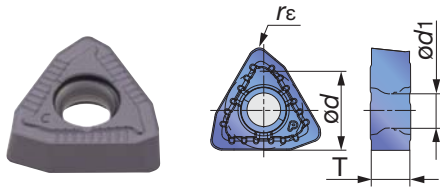

DS

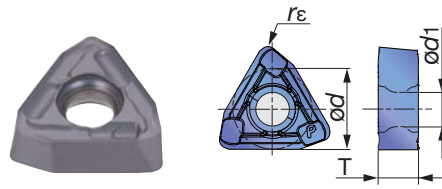

Designation	Coated		ød (in)	T (in)	ød1 (in)	rε (in)	ødC (in)
	AH9030	AH6030					
WWMU05X205R-DJ	●		0.228	0.094	0.098	0.020	ø0.812 - ø0.875
WWMU060306R-DJ	●		0.264	0.114	0.118	0.024	ø0.937 - ø1.062
WWMU08X408R-DJ	●		0.315	0.154	0.134	0.031	ø1.125 - ø1.250
WWMU09X510R-DJ	●		0.382	0.193	0.173	0.039	ø1.312 - ø1.500
WWMU11X512R-DJ	●		0.445	0.224	0.217	0.047	ø1.562 - ø1.812
WWMU13X512R-DJ	●		0.512	0.224	0.217	0.047	ø1.875 - ø2.000
WWMU05X205R-DS		●	0.228	0.094	0.098	0.020	ø0.812 - ø0.925
WWMU060306R-DS		●	0.264	0.114	0.118	0.024	ø0.941 - ø1.063
WWMU08X408R-DS		●	0.315	0.154	0.134	0.031	ø1.125 - ø1.250
WWMU09X510R-DS		●	0.382	0.193	0.173	0.039	ø1.312 - ø1.500
WWMU11X512R-DS		●	0.445	0.224	0.217	0.047	ø1.562 - ø1.812
WWMU13X512R-DS		●	0.512	0.224	0.217	0.047	ø1.875 - ø2.000

● : Line up



Indexable Drill

APPLICATION RANGE

*In case of Interrupted cutting, feed should be decreased.

Feed f (ipr)	*	0.002	0.002	0.002
Application	OK Flat surface 	OK Slant surface 	OK Cross hole 	OK Plunging
Feed f (ipr)	0.004	0.002	Disapprove	Disapprove
Application	OK Boring 	OK Round surface 	X Stacked plate 	X Back boring

*Please see the next page for cutting conditions.

STANDARD CUTTING CONDITIONS

ISO	Workpiece material	Selection criteria	Chip-breaker	Grades	Cutting speed Vc (sfm)
P	Low carbon steel (C < 0.3) (1018, 1020, 1026, etc.)	First choice	DS	AH6030	525 - 820
		Priority on wear resistance	DJ	AH9030	525 - 1050
	Carbon steel (C > 0.3) (1045, 1055, etc.)	First choice	DJ	AH9030	260 - 820
		Priority on impact resistance	DS	AH6030	260 - 820
	Low alloy steel (5120, etc.)	First choice	DS	AH6030	525 - 820
		Priority on wear resistance	DJ	AH9030	525 - 820
Alloy steel (4140, 8620, etc.)	First choice	DJ	AH9030	260 - 660	
	Priority on impact resistance	DS	AH6030	260 - 660	
M	Stainless steel (Austenitic) (304SS, 316SS, etc.)	First choice	DS	AH6030	330 - 660
		-	DJ	AH9030	330 - 660
	Stainless steel (Martensitic and ferritic) (430SS, 416SS, etc.)	First choice	DS	AH6030	330 - 660
		-	DJ	AH9030	330 - 660
	Stainless steel (Precipitation hardening) (17-4 PH, etc.)	First choice	DS	AH6030	260 - 400
		-	DJ	AH9030	260 - 400
K	Gray cast iron (Class 25, Class 30, etc.)	First choice	DJ	AH9030	260 - 820
		Priority on impact resistance	DS	AH6030	260 - 660
	Ductile cast iron (60-40-18, 60-55-06, etc.)	First choice	DJ	AH9030	260 - 660
		Priority on impact resistance	DS	AH6030	260 - 500
N	Aluminum alloy	First choice	DS	AH6030	660 - 1310
		-	DJ	AH9030	660 - 1310
S	High temperature alloy (Inconel 718, etc.)	First choice	DS	AH6030	60 - 200
		-	DJ	AH9030	60 - 200
	Titanium alloy (Ti-6Al-4V, etc.)	First choice	DS	AH6030	130 - 400
		-	DJ	AH9030	130 - 400
H	Hardened material (Over 40HRC)	First choice	DJ	AH9030	170 - 330
		Priority on impact resistance	DS	AH6030	130 - 260

Drill body of L/D = 4 is not recommended for stainless steel or superalloys drilling.



Indexable Drill

Feed: f (ipr)

L/D = 2, 3			L/D = 4		
ϕD_c (in)			ϕD_c (in)		
$\phi 0.787 - \phi 1.083$	$\phi 1.102 - \phi 1.496$	$\phi 1.535 - \phi 2.126$	$\phi 0.787 - \phi 1.063$	$\phi 1.102 - \phi 1.496$	$\phi 1.353 - \phi 2.126$
0.0015 - 0.004	0.0015 - 0.004	0.0015 - 0.004	0.0015 - 0.004	0.0015 - 0.004	0.0015 - 0.004
0.0015 - 0.004	0.0015 - 0.004	0.0015 - 0.004	0.0015 - 0.004	0.0015 - 0.004	0.0015 - 0.004
0.0023 - 0.006	0.0023 - 0.006	0.0031 - 0.007	0.0023 - 0.006	0.0023 - 0.006	0.0031 - 0.007
0.0015 - 0.005	0.0015 - 0.005	0.0015 - 0.006	0.0015 - 0.005	0.0015 - 0.005	0.0015 - 0.006
0.0015 - 0.005	0.0015 - 0.005	0.0015 - 0.005	0.0015 - 0.005	0.0015 - 0.005	0.0015 - 0.005
0.0023 - 0.005	0.0023 - 0.006	0.0023 - 0.006	0.0023 - 0.005	0.0023 - 0.006	0.0023 - 0.006
0.0023 - 0.006	0.0023 - 0.006	0.0031 - 0.007	0.0023 - 0.006	0.0023 - 0.006	0.0031 - 0.007
0.0015 - 0.005	0.0015 - 0.005	0.0015 - 0.006	0.0015 - 0.005	0.0015 - 0.005	0.0015 - 0.006
0.0015 - 0.004	0.0015 - 0.005	0.0015 - 0.005	0.0015 - 0.005	0.0015 - 0.005	0.0015 - 0.005
0.0015 - 0.004	0.0015 - 0.005	0.0015 - 0.005	0.0015 - 0.005	0.0015 - 0.005	0.0015 - 0.005
0.0015 - 0.004	0.0015 - 0.005	0.0015 - 0.005	0.0015 - 0.005	0.0015 - 0.005	0.0015 - 0.005
0.0015 - 0.004	0.0015 - 0.005	0.0015 - 0.005	0.0015 - 0.005	0.0015 - 0.005	0.0015 - 0.005
0.0015 - 0.004	0.0015 - 0.004	0.0015 - 0.004	0.0015 - 0.004	0.0015 - 0.004	0.0015 - 0.004
0.0015 - 0.004	0.0015 - 0.004	0.0015 - 0.004	0.0015 - 0.004	0.0015 - 0.004	0.0015 - 0.004
0.0023 - 0.006	0.0023 - 0.007	0.0031 - 0.008	0.0023 - 0.006	0.0023 - 0.006	0.0031 - 0.007
0.0023 - 0.005	0.0023 - 0.006	0.0031 - 0.007	0.0023 - 0.13	0.0023 - 0.006	0.0031 - 0.007
0.0023 - 0.006	0.0023 - 0.007	0.0031 - 0.008	0.0023 - 0.006	0.0023 - 0.006	0.0031 - 0.007
0.0023 - 0.005	0.0023 - 0.006	0.0031 - 0.007	0.0023 - 0.005	0.0023 - 0.006	0.0031 - 0.007
0.004 - 0.007	0.004 - 0.008	0.004 - 0.010	0.004 - 0.007	0.004 - 0.008	0.004 - 0.008
0.004 - 0.007	0.004 - 0.008	0.004 - 0.010	0.004 - 0.007	0.004 - 0.008	0.004 - 0.008
0.0015 - 0.0031	0.0015 - 0.0031	0.0015 - 0.004	0.0015 - 0.004	0.0015 - 0.004	0.0015 - 0.004
0.0015 - 0.0031	0.0015 - 0.0031	0.0015 - 0.004	0.0015 - 0.004	0.0015 - 0.004	0.0015 - 0.004
0.0023 - 0.004	0.0023 - 0.005	0.0023 - 0.006	0.0023 - 0.006	0.0023 - 0.006	0.0023 - 0.006
0.0023 - 0.004	0.0023 - 0.005	0.0023 - 0.006	0.0023 - 0.006	0.0023 - 0.006	0.0023 - 0.006
0.0015 - 0.0031	0.0015 - 0.0031	0.0015 - 0.004	0.0015 - 0.0031	0.0015 - 0.0031	0.0015 - 0.0031
0.0015 - 0.0031	0.0015 - 0.0031	0.0015 - 0.004	0.0015 - 0.0031	0.0015 - 0.0031	0.0015 - 0.0031



Indexable Drill

TUNGSIK-DRILL

TDXCF chamfering tool

Chamfering tool for "TungDrillTwisted" & "TungSix-Drill"

Indexable Drill

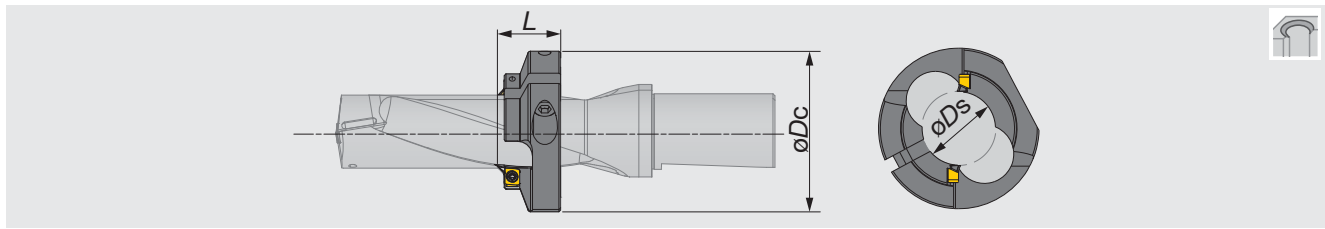

Inch	øDs	øDc	L	Drill	L/D = 2	L/D = 3	L/D = 4
TDXCF210L25	0.791	1.929	0.984	TDSU0812...			-
TDXCF230L25	0.870	1.929	0.984	TDSU0875...	0.825	1.700	-
TDXCF240L25	0.909	1.929	0.984	TDSU0937...	0.950	1.887	-
TDXCF260L30	0.982	2.520	1.181	TDSU1000...	0.878	1.878	-
TDXCF270L30	1.020	2.520	1.181	TDSU1062...	1.003	2.065	-
TDXCF290L30	1.098	2.520	1.181	TDSU1125...	-	-	3.486
TDXCF300L30	1.138	2.520	1.181	TDSU1187...	-	-	3.726
TDXCF320L30	1.217	2.520	1.181	TDSU1250...	-	-	3.976
TDXCF340L30	1.291	2.520	1.181	TDSU1312...	-	-	4.226
TDXCF350L30	1.331	2.520	1.181	TDSU1375...	-	-	4.476
TDXCF370L30	1.409	3.346	1.181	TDSU1437...	-	-	4.726
TDXCF380L30	1.449	3.346	1.181	TDSU1500...	-	-	4.977
TDXCF400L30	1.528	3.346	1.181	TDSU1562...	-	-	5.245
TDXCF410L30	1.567	3.346	1.181	TDSU1625...	-	-	5.496
TDXCF430L30	1.638	3.346	1.181	TDSU1687...	-	-	5.746
TDXCF450L30	1.717	3.346	1.181	TDSU1750...	-	-	5.998
TDXCF460L30	1.756	3.346	1.181	TDSU1812...	-	-	6.248
TDXCF480L30	1.835	3.346	1.181	TDSU1875...	-	-	6.496
TDXCF500L30	1.913	3.346	1.181	TDSU1937...	-	-	6.746
TDXCF510L30	1.953	3.346	1.181	TDSU2000...	-	-	6.996

SPARE PARTS

Designation	Screw for insert	Screw for ring	Wrench for insert	Wrench for ring
TDXCF210 - 250	CSPB-4S	CM6X16	IP-15D	P-5
TDXCF260 - 540	CSPB-4S	CM8X1.25X20-A	IP-15D	P-6

INSERT

XHGX-45A



Designation	GH130	Torque (lbf-ft)
XHGX090700R-45A	●	2.58

Caution in mounting the chamfering tool on the drill body

- ① Place the ring on the drill body and match the positions of flutes on drill and ring. Temporarily clamp the ring with the ring screw tightened lightly.
- ② Place the inserts and tighten the insert screw lightly.
- ③ Adjust the ring position with a presetter, height gauge or Vernier caliper. Securely tighten the ring screw, then the insert screw.



Match the positions of flutes on drill and ring.

(Inserts will be automatically set to the right positions.)

The cutting edge of the insert is in the ring flute.

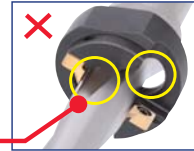

The flutes on drill and ring do not match.

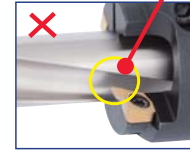

Indexable Drill

TUNGDRILLTWISTED

TDXU-FS L/D=2

L/D = 2, Flat with side & rear coolant port, Tool dia. $\varnothing 0.500''$ - $\varnothing 2.125''$



Indexable Drill

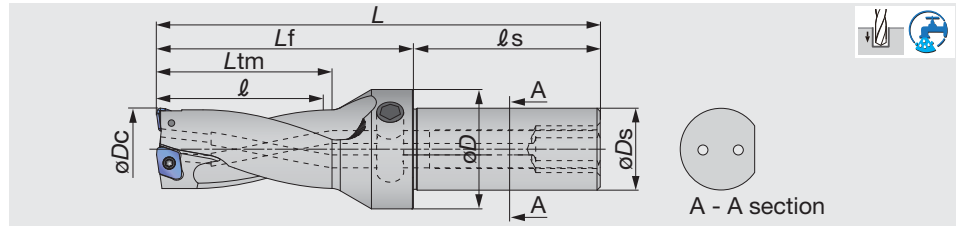

Inch	$\varnothing D_c$	$\varnothing D_s$	$\varnothing D$	l	l_s	L_{tm}	L_f	L	Max. offset** (radial)	lb	Insert
TDXU-0500FS-02	0.500	0.750	1.250	1.000	2.000	1.118	2.019	4.019	0.059	0.1	XPMT040104R-D*
TDXU-0531FS-02	0.531	0.750	1.250	1.062	2.000	1.180	2.089	4.089	0.039	0.1	XPMT040104R-D*
TDXU-0562FS-02	0.562	0.750	1.250	1.124	2.000	1.244	2.152	4.152	0.024	0.1	XPMT040104R-D*
TDXU-0625FS-02	0.625	0.750	1.250	1.250	2.000	1.370	2.283	4.283	0.047	0.1	XPMT050204R-D*
TDXU-0687FS-02	0.687	1.000	1.457	1.374	2.280	1.494	2.471	4.751	0.094	0.2	XPMT06X308R-D*
TDXU-0750FS-02	0.750	1.000	1.457	1.500	2.280	1.618	2.591	4.871	0.063	0.2	XPMT06X308R-D*
TDXU-0812FS-02	0.812	1.000	1.457	1.624	2.280	1.744	2.729	5.009	0.031	0.2	XPMT06X308R-D*
TDXU-0875FS-02	0.875	1.000	1.457	1.750	2.280	1.868	2.849	5.129	0.091	0.2	XPMT07H308R-D*
TDXU-0937FS-02	0.937	1.000	1.457	1.874	2.280	1.994	2.991	5.271	0.059	0.2	XPMT07H308R-D*
TDXU-1000FS-02	1.000	1.000	1.457	2.000	2.280	2.118	3.111	5.391	0.024	0.2	XPMT07H308R-D*
TDXU-1062FS-02	1.062	1.250	1.575	2.124	2.280	2.244	3.401	5.681	0.102	0.3	XPMT08T308R-D*
TDXU-1125FS-02	1.125	1.250	1.575	2.250	2.280	2.368	3.541	5.821	0.083	0.3	XPMT08T308R-D*
TDXU-1187FS-02	1.187	1.250	1.575	2.374	2.280	2.492	3.658	5.938	0.051	0.3	XPMT08T308R-D*
TDXU-1250FS-02	1.250	1.250	1.575	2.500	2.280	2.618	3.783	6.063	0.020	0.3	XPMT08T308R-D*
TDXU-1312FS-02	1.312	1.500	1.969	2.624	2.688	2.742	4.013	6.701	0.173	0.5	XPMT110412R-D*
TDXU-1375FS-02	1.375	1.500	1.969	2.750	2.688	2.868	4.155	6.843	0.142	0.5	XPMT110412R-D*
TDXU-1437FS-02	1.437	1.500	1.969	2.874	2.688	2.992	4.272	6.960	0.110	0.5	XPMT110412R-D*
TDXU-1500FS-02	1.500	1.500	1.969	3.000	2.688	3.118	4.413	7.101	0.079	0.5	XPMT110412R-D*
TDXU-1562FS-02	1.562	1.500	1.969	3.124	2.688	3.242	4.553	7.241	0.043	0.5	XPMT110412R-D*
TDXU-1625FS-02	1.625	1.500	2.165	3.250	2.688	3.368	4.728	7.416	0.244	0.6	XPMT150512R-D*
TDXU-1687FS-02	1.687	1.500	2.165	3.374	2.688	3.492	4.868	7.556	0.228	0.6	XPMT150512R-D*
TDXU-1750FS-02	1.750	1.500	2.165	3.500	2.688	3.618	4.986	7.674	0.197	0.7	XPMT150512R-D*
TDXU-1812FS-02	1.812	1.500	2.165	3.624	2.688	3.744	5.128	7.816	0.165	0.7	XPMT150512R-D*
TDXU-1875FS-02	1.875	1.500	2.165	3.750	2.688	3.868	5.251	7.939	0.126	0.8	XPMT150512R-D*
TDXU-1937FS-02	1.937	1.500	2.165	3.874	2.688	3.992	5.385	8.073	0.094	0.8	XPMT150512R-D*
TDXU-2000FS-02	2.000	1.500	2.165	4.000	2.688	4.118	5.510	8.198	0.055	0.9	XPMT150512R-D*
TDXU-2125FS-02	2.125	1.500	2.165	4.250	2.688	4.368	5.790	8.487	-	0.9	XPMT150512R-D*

** For offsetting on lathe

SPARE PARTS



Designation	Clamping screw	Torx driver	Plug *	
			Side port	Rear port (Optional parts)
TDXU500 - TDXU0562	CSPB-2H	IP-6DB	NPTF1/8	(NPTF1/4)
TDXU-0625FS-02	CSPB-2L043	IP-6DB	NPTF1/8	(NPTF1/4)
TDXU0687 - TDXU0812	CSPB-2.2	IP-7D	NPTF1/8	(SL25IN)
TDXU0875 - TDXU1000	CSPB-2.5	IP-8D	NPTF1/8	(SL25IN)
TDXU1062 - TDXU1250	CSTB-3	T-9D	NPTF1/4	(SL32IN)
TDXU1312 - TDXU1562	CSTB-4	T-15D	NPTF1/4	(SL38IN)
TDXU1625 - TDXU2125	CSTB-5	T-20D	NPTF1/4	(SL38IN)

* : Please see the dimensions on page E080.

Reference pages

Inserts → **E081**, Standard cutting conditions → **E082 - E083**

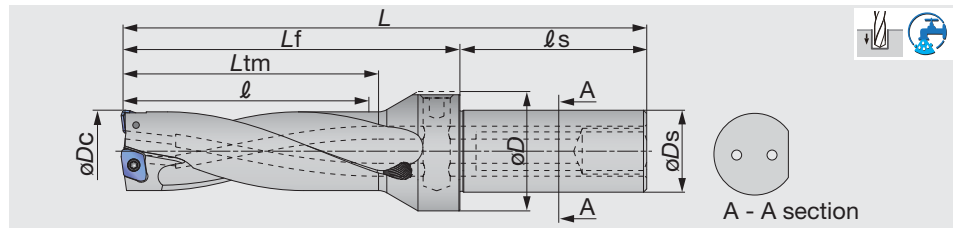

Inch	$\varnothing D_c$	$\varnothing D_s$	$\varnothing D$	l	l_s	L_{tm}	L_f	L	Max. offset** (radial)	lb	Insert
TDXU-0500FS-03	0.500	0.750	1.250	1.500	2.000	1.618	2.519	4.519	0.059	0.1	XPMT040104R-D*
TDXU-0531FS-03	0.531	0.750	1.250	1.593	2.000	1.711	2.620	4.620	0.039	0.1	XPMT040104R-D*
TDXU-0562FS-03	0.562	0.750	1.250	1.686	2.000	1.807	2.715	4.715	0.024	0.1	XPMT040104R-D*
TDXU-0625FS-03	0.625	0.750	1.250	1.875	2.000	1.996	2.909	4.909	0.047	0.1	XPMT050204R-D*
TDXU-0687FS-03	0.687	1.000	1.457	2.061	2.280	2.182	3.159	5.439	0.094	0.2	XPMT06X308R-D*
TDXU-0750FS-03	0.750	1.000	1.457	2.250	2.280	2.368	3.341	5.621	0.063	0.2	XPMT06X308R-D*
TDXU-0812FS-03	0.812	1.000	1.457	2.436	2.280	2.557	3.542	5.822	0.031	0.2	XPMT06X308R-D*
TDXU-0875FS-03	0.875	1.000	1.457	2.625	2.280	2.743	3.724	6.004	0.091	0.2	XPMT07H308R-D*
TDXU-0937FS-03	0.937	1.000	1.457	2.811	2.280	2.932	3.929	6.209	0.059	0.2	XPMT07H308R-D*
TDXU-1000FS-03	1.000	1.000	1.457	3.000	2.280	3.188	4.111	6.291	0.024	0.2	XPMT07H308R-D*
TDXU-1062FS-03	1.062	1.250	1.575	3.186	2.280	3.307	4.464	6.744	0.102	0.3	XPMT08T308R-D*
TDXU-1125FS-03	1.125	1.250	1.575	3.375	2.280	3.493	4.666	6.946	0.083	0.3	XPMT08T308R-D*
TDXU-1187FS-03	1.187	1.250	1.575	3.561	2.280	3.679	4.845	7.125	0.051	0.3	XPMT08T308R-D*
TDXU-1250FS-03	1.250	1.250	1.575	3.750	2.280	3.868	5.033	7.313	0.020	0.4	XPMT08T308R-D*
TDXU-1312FS-03	1.312	1.500	1.969	3.936	2.688	4.054	5.325	8.013	0.173	0.5	XPMT110412R-D*
TDXU-1375FS-03	1.375	1.500	1.969	4.125	2.688	4.243	5.530	8.218	0.142	0.5	XPMT110412R-D*
TDXU-1437FS-03	1.437	1.500	1.969	4.311	2.688	4.429	5.709	8.397	0.110	0.6	XPMT110412R-D*
TDXU-1500FS-03	1.500	1.500	1.969	4.500	2.688	4.618	5.913	8.601	0.079	0.6	XPMT110412R-D*
TDXU-1562FS-03	1.562	1.500	1.969	4.686	2.688	4.804	6.115	8.803	0.043	0.6	XPMT110412R-D*
TDXU-1625FS-03	1.625	1.500	2.165	4.875	2.688	4.993	6.353	9.041	0.244	0.7	XPMT150512R-D*
TDXU-1687FS-03	1.687	1.500	2.165	5.061	2.688	5.179	6.555	9.243	0.228	0.7	XPMT150512R-D*
TDXU-1750FS-03	1.750	1.500	2.165	5.250	2.688	5.368	6.736	9.424	0.197	0.8	XPMT150512R-D*
TDXU-1812FS-03	1.812	1.500	2.165	5.436	2.688	5.557	6.941	9.629	0.165	0.9	XPMT150512R-D*
TDXU-1875FS-03	1.875	1.500	2.165	5.625	2.688	5.743	7.126	9.814	0.126	0.9	XPMT150512R-D*
TDXU-1937FS-03	1.937	1.500	2.165	5.811	2.688	5.929	7.322	10.010	0.094	1.0	XPMT150512R-D*
TDXU-2000FS-03	2.000	1.500	2.165	6.000	2.688	6.118	7.510	10.198	0.055	1.0	XPMT150512R-D*
TDXU-2125FS-03	2.125	1.500	2.165	6.375	2.688	6.493	7.915	10.603	-	1.1	XPMT150512R-D*

** For offsetting on lathe

SPARE PARTS



Designation	Clamping screw	Torx driver	Plug *	
			Side port	Rear port (Optional parts)
TDXU500 - TDXU0562	CSPB-2H	IP-6DB	NPTF1/8	(NPTF1/4)
TDXU-0625FS-03	CSPB-2L043	IP-6DB	NPTF1/8	(NPTF1/4)
TDXU0687-TDXU0812	CSPB-2.2	IP-7D	NPTF1/8	(SL25IN)
TDXU0875 - TDXU1000	CSPB-2.5	IP-8D	NPTF1/8	(SL25IN)
TDXU1062 - TDXU1250	CSTB-3	T-9D	NPTF1/4	(SL32IN)
TDXU1312 - TDXU1562	CSTB-4	T-15D	NPTF1/4	(SL38IN)
TDXU1625 - TDXU2125	CSTB-5	T-20D	NPTF1/4	(SL38IN)

* : Please see the dimensions on page E080.

Reference pages

Inserts → E081, Standard cutting conditions → E082 - E083



Indexable Drill

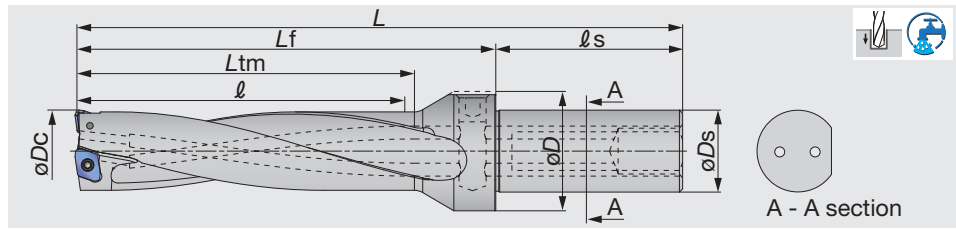

Inch	$\varnothing D_c$	$\varnothing D_s$	$\varnothing D$	l	l_s	L_{tm}	L_f	L	Max. offset** (radial)	lb	Insert
TDXU-0500FS-04	0.500	0.750	1.250	2.000	2.000	2.118	3.019	5.019	0.059	0.1	XPMT040104R-D*
TDXU-0531FS-04	0.531	0.750	1.250	2.124	2.000	2.242	3.151	5.151	0.039	0.1	XPMT040104R-D*
TDXU-0562FS-04	0.562	0.750	1.250	2.248	2.000	2.370	3.278	5.278	0.024	0.1	XPMT040104R-D*
TDXU-0625FS-04	0.625	0.750	1.250	2.500	2.000	2.622	3.535	5.535	0.047	0.1	XPMT050204R-D*
TDXU-0687FS-04	0.687	1.000	1.457	2.748	2.280	2.870	3.847	6.127	0.094	0.2	XPMT06X308R-D*
TDXU-0750FS-04	0.750	1.000	1.457	3.000	2.280	3.118	4.091	6.371	0.063	0.2	XPMT06X308R-D*
TDXU-0812FS-04	0.812	1.000	1.457	3.248	2.280	3.370	4.355	6.635	0.031	0.2	XPMT06X308R-D*
TDXU-0875FS-04	0.875	1.000	1.457	3.500	2.280	3.618	4.599	6.879	0.091	0.2	XPMT07H308R-D*
TDXU-0937FS-04	0.937	1.000	1.457	3.748	2.280	3.870	4.867	7.147	0.059	0.2	XPMT07H308R-D*
TDXU-1000FS-04	1.000	1.000	1.457	4.000	2.280	4.118	5.111	7.391	0.024	0.2	XPMT07H308R-D*
TDXU-1062FS-04	1.062	1.250	1.575	4.248	2.280	4.370	5.527	7.807	0.102	0.3	XPMT08T308R-D*
TDXU-1125FS-04	1.125	1.250	1.575	4.500	2.280	4.618	5.791	8.071	0.083	0.3	XPMT08T308R-D*
TDXU-1187FS-04	1.187	1.250	1.575	4.748	2.280	4.866	6.032	8.312	0.051	0.4	XPMT08T308R-D*
TDXU-1250FS-04	1.250	1.250	1.575	5.000	2.280	5.118	6.283	8.563	0.020	0.4	XPMT08T308R-D*
TDXU-1312FS-04	1.312	1.500	1.969	5.248	2.688	5.366	6.637	9.325	0.173	0.6	XPMT110412R-D*
TDXU-1375FS-04	1.375	1.500	1.969	5.500	2.688	5.618	6.905	9.593	0.142	0.6	XPMT110412R-D*
TDXU-1437FS-04	1.437	1.500	1.969	5.748	2.688	5.866	7.146	9.834	0.110	0.6	XPMT110412R-D*
TDXU-1500FS-04	1.500	1.500	1.969	6.000	2.688	6.118	7.413	10.101	0.079	0.6	XPMT110412R-D*
TDXU-1562FS-04	1.562	1.500	1.969	6.248	2.688	6.366	7.677	10.365	0.043	0.7	XPMT110412R-D*
TDXU-1625FS-04	1.625	1.500	2.165	6.500	2.688	6.618	7.978	10.666	0.244	0.8	XPMT150512R-D*
TDXU-1687FS-04	1.687	1.500	2.165	6.748	2.688	6.866	8.242	10.930	0.228	0.8	XPMT150512R-D*
TDXU-1750FS-04	1.750	1.500	2.165	7.000	2.688	7.118	8.486	11.174	0.197	0.9	XPMT150512R-D*
TDXU-1812FS-04	1.812	1.500	2.165	7.248	2.688	7.370	8.754	11.442	0.165	1.0	XPMT150512R-D*
TDXU-1875FS-04	1.875	1.500	2.165	7.500	2.688	7.618	9.001	11.689	0.126	1.1	XPMT150512R-D*
TDXU-1937FS-04	1.937	1.500	2.165	7.748	2.688	7.866	9.259	11.947	0.094	1.1	XPMT150512R-D*
TDXU-2000FS-04	2.000	1.500	2.165	8.000	2.688	8.118	9.510	12.198	0.055	1.2	XPMT150512R-D*
TDXU-2125FS-04	2.125	1.500	2.165	8.500	2.688	8.618	10.040	12.728	-	1.3	XPMT150512R-D*

** For offsetting on lathe

SPARE PARTS



Designation	Clamping screw	Torx driver	Plug *	
			Side port	Rear port (Optional parts)
TDXU500 - TDXU0562	CSPB-2H	IP-6DB	NPTF1/8	(NPTF1/4)
TDXU-0625FS-04	CSPB-2L043	IP-6DB	NPTF1/8	(NPTF1/4)
TDXU0687 - TDXU0812	CSPB-2.2	IP-7D	NPTF1/8	(SL25IN)
TDXU0875 - TDXU1000	CSPB-2.5	IP-8D	NPTF1/8	(SL25IN)
TDXU1062 - TDXU1250	CSTB-3	T-9D	NPTF1/4	(SL32IN)
TDXU1312 - TDXU1562	CSTB-4	T-15D	NPTF1/4	(SL38IN)
TDXU1625 - TDXU2000	CSTB-5	T-20D	NPTF1/4	(SL38IN)

* : Please see the dimensions on page E080.

Reference pages

Inserts → E081, Standard cutting conditions → E082 - E083

TUNGDRILLTWISTED

TDXU-FS L/D=5

L/D = 5, Flat with side & rear coolant port, Tool dia. $\varnothing 0.500''$ - $\varnothing 2.125''$

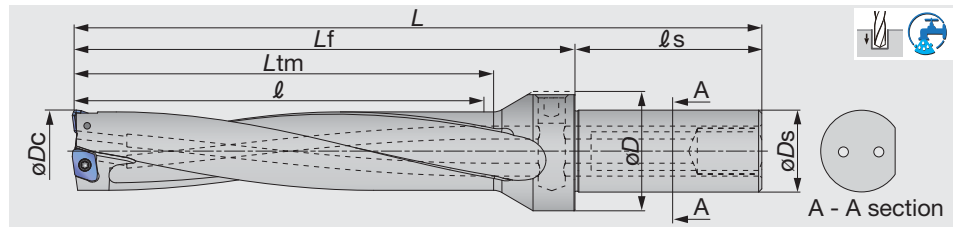

Inch	$\varnothing D_c$	$\varnothing D_s$	$\varnothing D$	l	l_s	L_{tm}	L_f	L	Max. offset** (radial)	lb	Insert
TDXU-0500FS-05	0.500	0.750	1.250	2.500	2.000	2.618	3.519	5.519	0.059	0.1	XPMT040104R-D*
TDXU-0531FS-05	0.531	0.750	1.250	2.655	2.000	2.773	3.682	5.682	0.039	0.1	XPMT040104R-D*
TDXU-0562FS-05	0.562	0.750	1.250	2.810	2.000	2.933	3.841	5.841	0.024	0.1	XPMT040104R-D*
TDXU-0625FS-05	0.625	0.750	1.250	3.125	2.000	3.248	4.161	6.161	0.047	0.1	XPMT050204R-D*
TDXU-0687FS-05	0.687	1.000	1.457	3.435	2.280	3.558	4.535	6.815	0.094	0.2	XPMT06X308R-D*
TDXU-0750FS-05	0.750	1.000	1.457	3.750	2.280	3.868	4.841	7.121	0.063	0.2	XPMT06X308R-D*
TDXU-0812FS-05	0.812	1.000	1.457	4.060	2.280	4.183	5.168	7.448	0.031	0.2	XPMT06X308R-D*
TDXU-0875FS-05	0.875	1.000	1.457	4.375	2.280	4.493	5.474	7.754	0.091	0.2	XPMT07H308R-D*
TDXU-0937FS-05	0.937	1.000	1.457	4.685	2.280	4.808	5.805	8.085	0.059	0.2	XPMT07H308R-D*
TDXU-1000FS-05	1.000	1.000	1.457	5.000	2.280	5.118	6.111	8.391	0.024	0.3	XPMT07H308R-D*
TDXU-1062FS-05	1.062	1.250	1.575	5.310	2.280	5.433	6.590	8.870	0.102	0.3	XPMT08T308R-D*
TDXU-1125FS-05	1.125	1.250	1.575	5.625	2.280	5.743	6.916	9.196	0.083	0.4	XPMT08T308R-D*
TDXU-1187FS-05	1.187	1.250	1.575	5.935	2.280	6.053	7.219	9.499	0.051	0.4	XPMT08T308R-D*
TDXU-1250FS-05	1.250	1.250	1.575	6.250	2.280	6.368	7.533	9.813	0.020	0.4	XPMT08T308R-D*
TDXU-1312FS-05	1.312	1.500	1.969	6.560	2.688	6.678	7.949	10.637	0.173	0.6	XPMT110412R-D*
TDXU-1375FS-05	1.375	1.500	1.969	6.875	2.688	6.993	8.280	10.968	0.142	0.6	XPMT110412R-D*
TDXU-1437FS-05	1.437	1.500	1.969	7.185	2.688	7.303	8.583	11.271	0.110	0.7	XPMT110412R-D*
TDXU-1500FS-05	1.500	1.500	1.969	7.500	2.688	7.618	8.913	11.601	0.079	0.7	XPMT110412R-D*
TDXU-1562FS-05	1.562	1.500	1.969	7.810	2.688	7.928	9.239	11.927	0.043	0.7	XPMT110412R-D*
TDXU-1625FS-05	1.625	1.500	2.165	8.125	2.688	8.243	9.603	12.291	0.244	0.8	XPMT150512R-D*
TDXU-1687FS-05	1.687	1.500	2.165	8.435	2.688	8.553	9.929	12.617	0.228	0.9	XPMT150512R-D*
TDXU-1750FS-05	1.750	1.500	2.165	8.750	2.688	8.868	10.236	12.924	0.197	1.0	XPMT150512R-D*
TDXU-1812FS-05	1.812	1.500	2.165	9.060	2.688	9.183	10.567	13.255	0.165	1.1	XPMT150512R-D*
TDXU-1875FS-05	1.875	1.500	2.165	9.375	2.688	9.493	10.876	13.564	0.126	1.2	XPMT150512R-D*
TDXU-1937FS-05	1.937	1.500	2.165	9.685	2.688	9.803	11.196	13.884	0.094	1.3	XPMT150512R-D*
TDXU-2000FS-05	2.000	1.500	2.165	10.000	2.688	10.118	11.510	14.198	0.055	1.4	XPMT150512R-D*
TDXU-2125FS-05	2.125	1.500	2.165	10.625	2.688	10.743	12.165	14.853	-	1.5	XPMT150512R-D*

** For offsetting on lathe

SPARE PARTS



Designation	Clamping screw	Torx driver	Plug *	
			Side port	Rear port (Optional parts)
TDXU500 - TDXU0562	CSPB-2H	IP-6DB	NPTF1/8	(NPTF1/4)
TDXU-0625FS-05	CSPB-2L043	IP-6DB	NPTF1/8	(NPTF1/4)
TDXU0687 - TDXU0812	CSPB-2.2	IP-7D	NPTF1/8	(SL25IN)
TDXU0875 - TDXU1000	CSPB-2.5	IP-8D	NPTF1/8	(SL25IN)
TDXU1062 - TDXU1250	CSTB-3	T-9D	NPTF1/4	(SL32IN)
TDXU1312 - TDXU1562	CSTB-4	T-15D	NPTF1/4	(SL38IN)
TDXU1625 - TDXU2000	CSTB-5	T-20D	NPTF1/4	(SL38IN)

* : Please see the dimensions on page E080.

Reference pages

Inserts → E081, Standard cutting conditions → E082 - E083



Indexable Drill

TungCap C-TDX

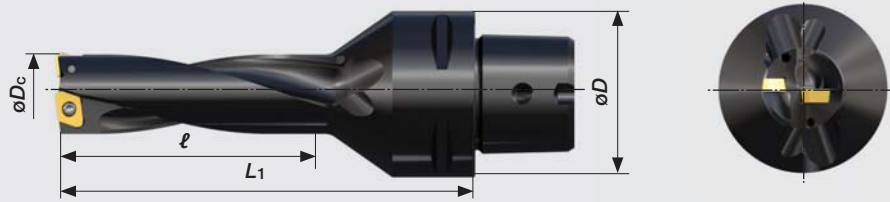

Indexable Drill

Metric	ϕD	ϕD_c	L_1	ℓ	Max. offset** (radial)	Insert
C4TDX150L082-3	40	15	82	45	0.9	XPMT050204R-D*
C4TDX200L101-3	40	20	101	60	0.5	XPMT06X308R-D*
C4TDX250L125-3	40	25	125	75	0.4	XPMT07H308R-D*
C4TDX300L139-3	40	30	139	90	0.7	XPMT08T308R-D*
C6TDX200L101-3	63	20	101	60	0.5	XPMT06X308R-D*
C6TDX250L121-3	63	25	121	75	0.4	XPMT07H308R-D*
C6TDX300L139-3	63	30	139	90	0.7	XPMT08T308R-D*
C6TDX350L159-3	63	35	159	105	1.8	XPMT110412R-D*
C6TDX400L177-3	63	40	177	120	0.5	XPMT110412R-D*

Applicable for 14 MPa pressure coolant

** For offsetting on lathe

SPARE PARTS



Designation	Clamping screw	Screw
C4TDX150L082-3	CSTB-2L040	T-6D
C4TDX200L101-3	CSTB-2.2R	T-7D
C4TDX250L125-3	CSTB-2.5	T-8D
C4TDX300L139-3	CSTB-3	T-9D
C6TDX200L101-3	CSTB-2.2R	T-7D
C6TDX250L121-3	CSTB-2.5	T-8D
C6TDX300L139-3	CSTB-3	T-9D
C6TDX350L159-3	CSTB-4	T-15D
C6TDX400L177-3	CSTB-4	T-15D

Side port

Inch	D	H	L	W	G	L1	C
NPTF1/8	0.374	0.161	0.312	0.187	NPTF1/8	0.156	0.028
NPTF1/4	0.492	0.228	0.437	0.250	NPTF1/4	0.239	0.039

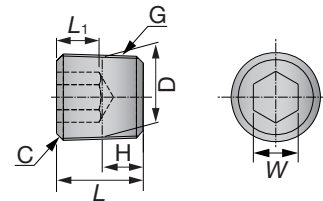

Rear port

Inch	D	H	L	W	G1	G2
SL25IN	0.866	0.669	0.472	0.669	M16X1.5	NPTF1/8
SL32IN	1.142	0.827	0.591	0.866	M22X2.0	NPTF1/4
SL38IN	1.496	0.827	0.591	0.866	M30X2.0	NPTF1/4

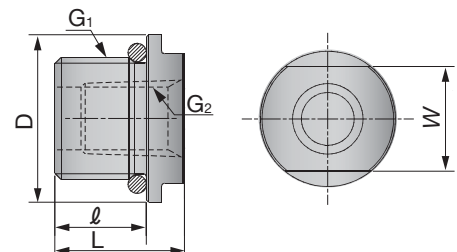

Reference pages

Inserts → E081, Standard cutting conditions → E082 - E083

INSERT

DJ

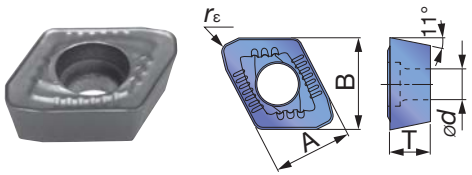

Designation	Coated				A (in)	B (in)	T (in)	ød (in)	rc (in)	øDc (in)
	AH9030	AH6030	AH725	T1115						
XPMT040104R-DJ	●	●	●	●	0.169	0.177	0.063	0.091	0.016	ø0.500 - ø0.562
XPMT050204R-DJ	●	●	●	●	0.205	0.213	0.094	0.091	0.016	ø0.625
XPMT06X308R-DJ	●	●	●	●	0.236	0.276	0.118	0.096	0.031	ø0.687 - ø0.812
XPMT07H308R-DJ	●	●	●	●	0.276	0.323	0.142	0.110	0.031	ø0.875 - ø1.000
XPMT08T308R-DJ	●	●	●	●	0.335	0.390	0.156	0.134	0.031	ø1.062 - ø1.250
XPMT110412R-DJ	●	●	●	●	0.441	0.492	0.187	0.173	0.047	ø1.312 - ø1.562
XPMT150512R-DJ	●	●	●	●	0.591	0.634	0.219	0.217	0.047	ø1.625 - ø2.000

DS

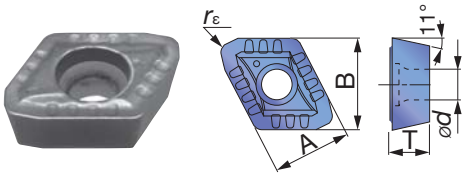

Designation	Coated		A (in)	B (in)	T (in)	ød (in)	rc (in)	øDc (in)
	AH6030	AH725						
XPMT040104R-DS	●	●	0.169	0.177	0.063	0.091	0.016	ø0.500 - ø0.562
XPMT050204R-DS	●	●	0.205	0.213	0.094	0.091	0.016	ø0.625
XPMT06X308R-DS	●	●	0.236	0.276	0.118	0.096	0.031	ø0.687 - ø0.812
XPMT07H308R-DS	●	●	0.276	0.323	0.142	0.110	0.031	ø0.875 - ø1.000
XPMT08T308R-DS	●	●	0.335	0.390	0.156	0.134	0.031	ø1.062 - ø1.250
XPMT110412R-DS	●	●	0.441	0.492	0.187	0.173	0.047	ø1.312 - ø1.562
XPMT150512R-DS	●	●	0.591	0.634	0.219	0.217	0.047	ø1.625 - ø2.000

DW

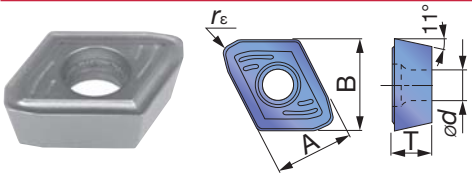

Designation	Coated			A (in)	B (in)	T (in)	ød (in)	rc (in)	øDc (in)
	AH9030	AH6030	AH725						
XPMT040104R-DW	●	●	●	0.169	0.177	0.063	0.091	0.016	ø0.500 - ø0.562
XPMT050204R-DW	●	●	●	0.205	0.213	0.094	0.091	0.016	ø0.625
XPMT06X308R-DW	●	●	●	0.236	0.276	0.118	0.096	0.031	ø0.687 - ø0.812
XPMT07H308R-DW	●	●	●	0.276	0.323	0.142	0.110	0.031	ø0.875 - ø1.000
XPMT08T308R-DW	●	●	●	0.335	0.390	0.156	0.134	0.031	ø1.062 - ø1.250
XPMT110412R-DW	●	●	●	0.441	0.492	0.187	0.173	0.047	ø1.312 - ø1.562
XPMT150512R-DW	●	●	●	0.591	0.634	0.219	0.217	0.047	ø1.625 - ø2.000

DG

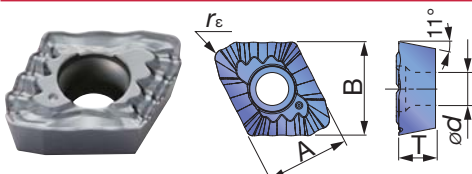

Designation	Coated	A (in)	B (in)	T (in)	ød (in)	rc (in)	øDc (in)
	AH725						
XPMT08T308R-DG	●	0.335	0.390	0.156	0.134	0.031	ø1.062 - ø1.250
XPMT110412R-DG	●	0.441	0.492	0.187	0.173	0.047	ø1.312 - ø1.562
XPMT150512R-DG	●	0.591	0.634	0.219	0.217	0.047	ø1.625 - ø2.000

● : Line up



Indexable Drill

RECOMMENDED INSERT

ISO	Workpiece material	First choice	High feed	High speed	Troubleshooting			
					Chipping resistance	Wear resistance	Surface finish	Chip control
P	Low carbon steel (C ≤ 0.3%)	DS, AH6030	-	-	DS, AH725	-	DW, AH6030	DG, AH725
	Carbon steel (C > 0.3%) Alloy steel	DJ, AH6030	DW, AH6030	DJ, AH9030	DW, AH725	DJ, AH9030	DW, AH6030	-
	Low alloy steel	DS, AH6030	-	-	DS, AH725	-	DW, AH6030	-
M	Stainless steel	DS, AH6030	-	-	DS, AH725	-	DW, AH6030	DG, AH725
K	Gray cast iron	DJ, AH9030	DW, AH9030	DJ, T1115	DW, AH725	-	DW, AH9030	-
	Ductile cast iron	DJ, AH9030	DW, AH9030	-	DW, AH725	-	DW, AH9030	-
N	Aluminum alloys	DJ, AH725	DW, AH725	DS, AH6030	-	-	DW, AH725	DG, AH725
S	Titanium alloys Heat-resistant alloys	DS, AH6030	-	-	DW, AH725	-	DW, AH725	DG, AH725
H	Hardened steel	DJ, AH9030	DW, AH9030	-	DW, AH725	-	DW, AH9030	-



Indexable Drill

STANDARD CUTTING CONDITIONS

ISO	Workpiece material	Cutting speed Vc (sfm)	Series L/D	Feed: f (ipr)				
				ø0.500" - ø0.562"	ø0.625"	ø0.687" - ø1.000"	ø1.062" - ø1.25"	ø1.312" - ø2.000"
P	Low carbon steel (C ≤ 0.3%) 1018, 1020, 1026, etc.	520 - 1050	2D, 3D	0.0008 - 0.0024	0.0008 - 0.0024	0.0016 - 0.0039	0.0016 - 0.0039	0.0016 - 0.0039
		520 - 1050	4D, 5D	0.0008 - 0.0024	0.0008 - 0.0024	0.0016 - 0.0039	0.0016 - 0.0039	0.0016 - 0.0039
	Carbon steel (C > 0.3%) 1045, 1055, etc.	260 - 820	2D, 3D	0.0016 - 0.0039	0.0016 - 0.0047	0.0016 - 0.0051	0.0024 - 0.0059	0.0032 - 0.0073
		260 - 820	4D, 5D	0.0016 - 0.0032	0.0016 - 0.0032	0.0016 - 0.0039	0.0024 - 0.0047	0.0032 - 0.0055
	Low alloy steel 5120, etc.	520 - 820	2D, 3D	0.0016 - 0.0032	0.0016 - 0.0032	0.0024 - 0.0047	0.0024 - 0.0047	0.0024 - 0.0055
		520 - 820	4D, 5D	0.0016 - 0.0032	0.0016 - 0.0032	0.0024 - 0.0047	0.0024 - 0.0047	0.0024 - 0.0055
M	Stainless steel (Austenitic) 304SS, 316SS, etc.	330 - 650	2D, 3D	0.0008 - 0.0032	0.0008 - 0.0032	0.0016 - 0.0039	0.0016 - 0.0047	0.0016 - 0.0047
		330 - 650	4D, 5D	0.0008 - 0.0032	0.0008 - 0.0032	0.0016 - 0.0039	0.0016 - 0.0047	0.0016 - 0.0047
	Stainless steel (Martensitic, Ferritic) 430SS, 416SS, etc.	330 - 650	2D, 3D	0.0008 - 0.0032	0.0008 - 0.0032	0.0016 - 0.0039	0.0016 - 0.0047	0.0016 - 0.0047
		330 - 650	4D, 5D	0.0008 - 0.0032	0.0008 - 0.0032	0.0016 - 0.0039	0.0016 - 0.0047	0.0016 - 0.0047
	Stainless steel (Precipitation hardening) 17-4 PH, etc.	260 - 390	2D, 3D	0.0016 - 0.0032	0.0016 - 0.0032	0.0016 - 0.0032	0.0016 - 0.0039	0.0024 - 0.0039
		260 - 390	4D, 5D	0.0016 - 0.0032	0.0016 - 0.0032	0.0016 - 0.0032	0.0016 - 0.0039	0.0024 - 0.0039
K	Gray cast iron Class 25, Class 30, etc.	260 - 820	2D, 3D	0.0024 - 0.0047	0.0024 - 0.0047	0.0024 - 0.0059	0.0024 - 0.0073	0.0032 - 0.0082
		260 - 820	4D, 5D	0.0024 - 0.0039	0.0024 - 0.0039	0.0024 - 0.0047	0.0024 - 0.0055	0.0032 - 0.0065
	Ductile cast iron 60-40-18, 60-55-06, etc.	260 - 660	2D, 3D	0.0016 - 0.0047	0.0016 - 0.0047	0.0024 - 0.0059	0.0024 - 0.0073	0.0032 - 0.0082
		260 - 660	4D, 5D	0.0016 - 0.0039	0.0016 - 0.0039	0.0024 - 0.0047	0.0024 - 0.0055	0.0032 - 0.0065
N	Non ferrous material 6061, 7075, etc.	650 - 1310	2D, 3D	0.0039 - 0.0047	0.0039 - 0.0059	0.0059 - 0.0082	0.0059 - 0.0082	0.0059 - 0.0100
		650 - 1310	4D, 5D	0.0032 - 0.0047	0.0032 - 0.0047	0.0047 - 0.0065	0.0047 - 0.0065	0.0047 - 0.0082
S	Heat-resistant alloys Inconel 718, etc.	60 - 200	2D, 3D	0.0016 - 0.0032	0.0016 - 0.0032	0.0016 - 0.0039	0.0016 - 0.0039	0.0016 - 0.0039
		60 - 200	4D, 5D	0.0016 - 0.0032	0.0016 - 0.0032	0.0016 - 0.0039	0.0016 - 0.0039	0.0016 - 0.0039
	Titanium alloys Ti-6Al-4V, etc.	130 - 400	2D, 3D	0.0024 - 0.0039	0.0024 - 0.0039	0.0024 - 0.0047	0.0024 - 0.0047	0.0024 - 0.0047
		130 - 400	4D, 5D	0.0024 - 0.0032	0.0024 - 0.0032	0.0024 - 0.0039	0.0024 - 0.0039	0.0024 - 0.0039
H	Hardened material ≥ 40HRC	130 - 330	2D, 3D	0.0016 - 0.0032	0.0016 - 0.0032	0.0016 - 0.0039	0.0016 - 0.0039	0.0016 - 0.0039
		130 - 330	4D, 5D	0.0016 - 0.0032	0.0016 - 0.0032	0.0016 - 0.0032	0.0016 - 0.0032	0.0016 - 0.0032

Standard cutting conditions for DG type chipbreaker

ISO	Workpiece material	Cutting speed Vc (sfm)	Series L/D	Feed: f (ipr)	
				ø1.062" - ø1.250"	ø1.312" - ø2.000"
P	Low carbon steel (C ≤ 0.3%) 1018, 1020, 1026, etc.	260 - 590	2D, 3D 4D, 5D	0.0016 - 0.0039	

- For small drill diameters, lower feed rate should be applied.
- In case of workpiece materials with hardness of more than 40 HRC, the feed rate should be less than 50% of the recommended feed.
- For difficult to cut materials, such as heat resistant alloys, that generate high volume of cutting heat during machining, the cutting speed should be less than 20% of the recommended value for carbon steel.
- For high feed machining with DW type chipbreaker, the feed rate should be

- approximately 1.5 times higher than the standard rate shown above.
- High speed machining applies to operations with a cutting speed of more than 150 m/min.
- When using DW type chipbreaker for troubleshooting, the operation should be within the range of standard cutting conditions.
- DG type chipbreaker is suitable for large sized machines with low RPM spindle. If chattering occurs, the feed rate should be lowered.



Indexable Drill

TUNGDRILLTWISTED

TDXCF chamfering tool

Chamfering tool for "TungDrillTwisted" & "TungSix-Drill"



Indexable Drill

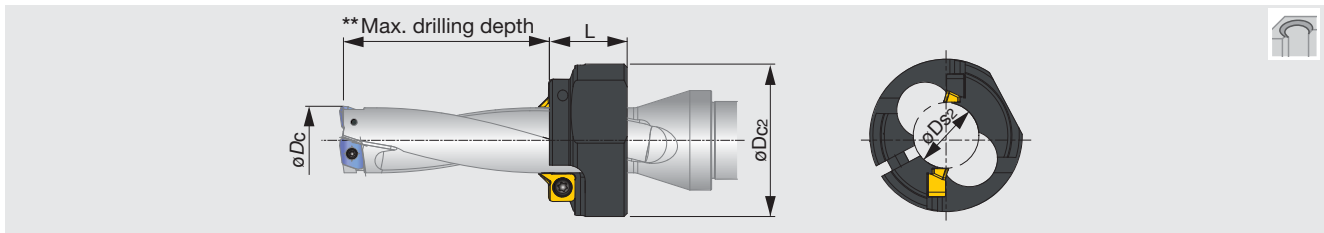

**Max. drilling depth with chamfering ring

Inch	øDs2	øDc2	L	øDc	Drill	L/D = 2	L/D = 3	L/D = 4	L/D = 5
TDXCF150L25	0.561	1.929	0.984	0.562	TDXU-0562FS-*	0.295	0.857	1.419	1.981
TDXCF160L25	0.600	1.929	0.984	0.625	TDXU-0625FS-*	0.433	1.058	1.683	2.308
TDXCF180L25	0.681	1.929	0.984	0.687	TDXU-0687FS-*	0.591	1.278	1.965	2.652
TDXCF190L25	0.713	1.929	0.984	0.750	TDXU-0750FS-*	0.709	1.459	2.209	2.959
TDXCF210L25	0.791	1.929	0.984	0.812	TDXU-0812FS-*	0.866	1.678	2.490	3.302
TDXCF230L25	0.870	1.929	0.984	0.875	TDXU-0875FS-*	0.984	1.859	2.734	3.609
TDXCF240L25	0.909	1.929	0.984	0.937	TDXU-0937FS-*	1.142	2.079	3.016	3.953
TDXCF260L30	0.982	2.520	1.181	1.000	TDXU-1000FS-*	1.102	2.102	3.102	4.102
TDXCF270L30	1.020	2.520	1.181	1.062	TDXU-1062FS-*	1.220	2.282	3.344	4.406
TDXCF290L30	1.098	2.520	1.181	1.125	TDXU-1125FS-*	1.378	2.503	3.628	4.753
TDXCF300L30	1.138	2.520	1.181	1.187	TDXU-1187FS-*	1.496	2.683	3.870	5.057
TDXCF320L30	1.217	2.520	1.181	1.25	TDXU-1250FS-*	1.654	2.904	4.154	5.404
TDXCF340L30	1.291	2.520	1.181	1.312	TDXU-1312FS-*	1.772	3.084	4.396	5.708
TDXCF350L30	1.331	2.520	1.181	1.375	TDXU-1375FS-*	1.929	3.304	4.679	6.054
TDXCF370L30	1.409	3.346	1.181	1.437	TDXU-1437FS-*	2.047	3.484	4.921	6.358
TDXCF380L30	1.449	3.346	1.181	1.500	TDXU-1500FS-*	2.204	3.704	5.204	6.704
TDXCF400L30	1.528	3.346	1.181	1.562	TDXU-1562FS-*	2.362	3.924	5.486	7.048
TDXCF410L30	1.567	3.346	1.181	1.625	TDXU-1625FS-*	2.480	4.105	5.730	7.355
TDXCF430L30	1.638	3.346	1.181	1.687	TDXU-1687FS-*	2.638	4.325	6.012	7.699
TDXCF450L30	1.717	3.346	1.181	1.750	TDXU-1750FS-*	2.795	4.545	6.295	8.045
TDXCF460L30	1.756	3.346	1.181	1.812	TDXU-1812FS-*	2.913	4.725	6.537	8.349
TDXCF480L30	1.835	3.346	1.181	1.875	TDXU-1875FS-*	3.071	4.946	6.821	8.696
TDXCF500L30	1.913	3.346	1.181	1.937	TDXU-1937FS-*	3.228	5.165	7.102	9.039
TDXCF510L30	1.953	3.346	1.181	2.000	TDXU-2000FS-*	3.346	5.346	7.346	9.346

SPARE PARTS

Designation	Screw for insert	Screw for ring	Wrench for insert	Wrench for ring
TDXCF150L25 - TDXCF250L25	CSPB-4S	CM6X16	IP-15D	P-5
TDXCF260L30 - TDXCF510L30	CSPB-4S	CM8X1.25X20-A	IP-15D	P-6

INSERT

XHGX-45A



Designation	GH130	Torque (lbf-ft)
XHGX090700R-45A	●	2.58

Caution in mounting the chamfering tool on the drill body

- ① Place the ring on the drill body and match the positions of flutes on drill and ring. Temporarily clamp the ring with the ring screw tightened lightly.
- ② Place the inserts and tighten the insert screw lightly.
- ③ Adjust the ring position with a presetter, height gauge, or Vernier caliper. Securely tighten the ring screw, then the insert screw.

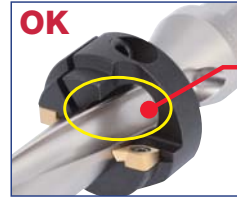

Match the positions of flutes on drill and ring.

(Inserts will be automatically set to the right positions.)

The cutting edge of the insert is in the ring flute.

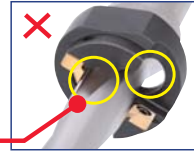

The flutes on drill and ring do not match.

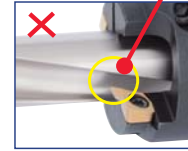

Indexable Drill

EZ sleeve

Eccentric sleeves for "TungDrillTwisted" & "TungSix-Drill"

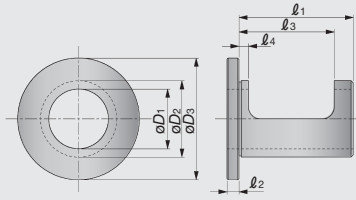

Inch	$\varnothing D_1$	$\varnothing D_2$	$\varnothing D_3$	l_1	l_2	l_3	l_4
EZ0.75-1.25	0.750	1.250	1.750	2.000	0.200	1.575	0.375
EZ1.00-1.50	1.000	1.500	2.000	2.500	0.200	1.965	0.375
EZ1.25-2.00	1.250	2.000	2.500	2.700	0.200	1.965	0.375
EZ1.50-2.00	1.500	2.000	2.750	2.900	0.200	1.965	0.375

SPARE PARTS

Designation	Wrench
EZ...	P-2.5



Indexable Drill

Use EZ sleeves for the following purposes

Hole diameter adjustment on the milling machine

Adjusting the finishing diameter when milling

Adjusting the finishing diameter in tool-rotating applications such as on machining centres and milling machines:



By using **EZ sleeve**, the finishing diameter can be adjusted in the range from **+0.024" to -0.008"**.



Scale for adjusting finishing diameter in milling (Periphery of sleeve)

Adjusting cutting edge height on lathe

Lathe

Adjusting of the cutting edge height in work rotating applications such as on lathes:



By using **EZ sleeve**, the cutting edge height can be adjusted in the range from **+0.012" to -0.008"**. It results in eliminating troubles caused by improper cutting-edge height.



Scale for adjusting cutting edge height in turning (Front face of sleeve)

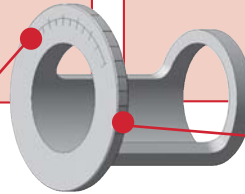

Indexable Drill

Setting of EZ sleeve

Adjusting finishing diameter in milling

As shown in the Figure below, set the EZ sleeve between the drill shank and the toolholder.

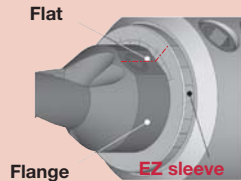

Align the graduated scale on the periphery of the EZ sleeve with the center of the flat of the drill flange. In the Figure shown below, the sleeve is set so that the finishing diameter will be increased by 0.016" (0.4 mm).

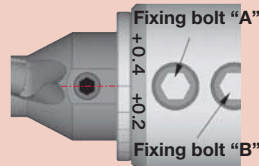

When rotating the EZ sleeve, insert the wrench into the hole at the flange periphery and rotate the EZ sleeve. Screws A + B have to be loosened. Secure the drill by screw A. Secure the EZ sleeve by lightly tightening screw B. Tighten screw B only lightly otherwise EZ sleeve can be damaged!

Adjusting cutting edge height on lathe

As shown in the Figure below, set the EZ sleeve between the drill shank and the toolblock.

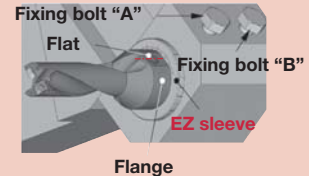

Align the graduated scale on the front face of the Esleeve with the center of the flat of the drill flange. In the Figure shown below, the sleeve is set so that the center of the drill will shift by 0.004" (0.1 mm) to the plus (+) direction.

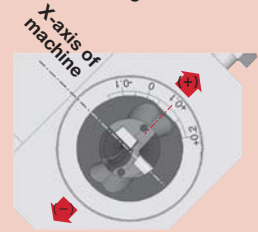

Cautious points

- Can not be used for collect chuck holders.
- Over L/D 4 or bigger adjustment, please reduce feed.
- For smaller adjustment, the drill itself will interfere with the hole diameter. It is recommended that hole diameter should be adjusted to a larger diameter than the drill diameter.

TUNGDRILLBIG

TDB, TDS cartridge set

L/D = 2.5, dia. $\phi 2.250'' - \phi 3.157''$, diameter adjustable with setting plate

Indexable Drill

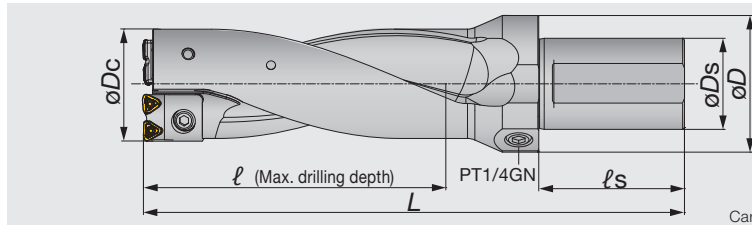

Cartridge set is sold separately.

Body	Cartridge set	ϕD_c	ϕD_s	ϕD	ℓ	ℓ_s	L	lb	Setting plate		Insert
Inch	Inch								Designation	Thickness	
TDBU2250-2447-2.5	TDSCA57-62	2.250	2.0	2.953	6.117	4.0	11.957	8.8	-	-	WWMU08X408R-D*
TDBU2250-2447-2.5	TDSCA57-62	2.289	2.0	2.953	6.117	4.0	11.957	8.8	AP0801	0.020	WWMU08X408R-D*
TDBU2250-2447-2.5	TDSCA57-62	2.329	2.0	2.953	6.117	4.0	11.957	8.8	AP0802	0.039	WWMU08X408R-D*
TDBU2250-2447-2.5	TDSCA57-62	2.368	2.0	2.953	6.117	4.0	11.957	8.8	AP0803	0.059	WWMU08X408R-D*
TDBU2250-2447-2.5	TDSCA57-62	2.407	2.0	2.953	6.117	4.0	11.957	8.8	AP0804	0.079	WWMU08X408R-D*
TDBU2250-2447-2.5	TDSCA57-62	2.447	2.0	2.953	6.117	4.0	11.957	8.8	AP0805	0.098	WWMU08X408R-D*
TDBU2461-2579-2.5	TDSCA63-66	2.461	2.0	2.953	6.447	4.0	12.567	10.1	-	-	WWMU08X408R-D*
TDBU2461-2579-2.5	TDSCA63-66	2.500	2.0	2.953	6.447	4.0	12.567	10.1	AP0801	0.020	WWMU08X408R-D*
TDBU2461-2579-2.5	TDSCA63-66	2.539	2.0	2.953	6.447	4.0	12.567	10.1	AP0802	0.039	WWMU08X408R-D*
TDBU2461-2579-2.5	TDSCA63-66	2.579	2.0	2.953	6.447	4.0	12.567	10.1	AP0803	0.059	WWMU08X408R-D*
TDBU2632-2868-2.5	TDSCA67-73	2.632	2.0	2.953	7.170	4.0	13.544	11.9	-	-	WWMU09X510R-D*
TDBU2632-2868-2.5	TDSCA67-73	2.671	2.0	2.953	7.170	4.0	13.544	11.9	AP1101	0.020	WWMU09X510R-D*
TDBU2632-2868-2.5	TDSCA67-73	2.711	2.0	2.953	7.170	4.0	13.544	11.9	AP1102	0.039	WWMU09X510R-D*
TDBU2632-2868-2.5	TDSCA67-73	2.750	2.0	2.953	7.170	4.0	13.544	11.9	AP1103	0.059	WWMU09X510R-D*
TDBU2632-2868-2.5	TDSCA67-73	2.789	2.0	2.953	7.170	4.0	13.544	11.9	AP1104	0.079	WWMU09X510R-D*
TDBU2632-2868-2.5	TDSCA67-73	2.829	2.0	2.953	7.170	4.0	13.544	11.9	AP1105	0.098	WWMU09X510R-D*
TDBU2632-2868-2.5	TDSCA67-73	2.868	2.0	2.953	7.170	4.0	13.544	11.9	AP1106	0.118	WWMU09X510R-D*
TDBU2921-3157-2.5	TDSCA74-80	2.921	2.0	2.953	7.894	4.0	13.973	13.7	-	-	WWMU11X512R-D*
TDBU2921-3157-2.5	TDSCA74-80	2.961	2.0	2.953	7.894	4.0	13.973	13.7	AP1101	0.020	WWMU11X512R-D*
TDBU2921-3157-2.5	TDSCA74-80	3.000	2.0	2.953	7.894	4.0	13.973	13.7	AP1102	0.039	WWMU11X512R-D*
TDBU2921-3157-2.5	TDSCA74-80	3.039	2.0	2.953	7.894	4.0	13.973	13.7	AP1103	0.059	WWMU11X512R-D*
TDBU2921-3157-2.5	TDSCA74-80	3.079	2.0	2.953	7.894	4.0	13.973	13.7	AP1104	0.079	WWMU11X512R-D*
TDBU2921-3157-2.5	TDSCA74-80	3.118	2.0	2.953	7.894	4.0	13.973	13.7	AP1105	0.098	WWMU11X512R-D*
TDBU2921-3157-2.5	TDSCA74-80	3.157	2.0	2.953	7.894	4.0	13.973	13.7	AP1106	0.118	WWMU11X512R-D*

Body

SPARE PARTS



Designation	① Setting plate screw	Plug	② Cartridge screw	③ Setting plate	③ Setting plate 1	③ Setting plate 2	③ Setting plate 3	③ Setting plate 4	③ Setting plate 5	Wrench for setting plate	Wrench for cartridge	Wrench for plug	④ Washer
TDBU2250-2447-2.5	CSTB-3	PT1/4GN	CM5X0.8X12	AP0801	AP0802	AP0803	AP0804	AP0805	-	T-9D	P-4	P-6	5.3X10X1
TDBU2461-2579-2.5	CSTB-3	PT1/4GN	CHHM6-15	AP0801	AP0802	AP0803	-	-	-	T-9D	P-5	P-6	6.4X12.5X1.6
TDBU2632-2868-2.5	CSTB-3	PT1/4GN	CM6X16	AP1101	AP1102	AP1103	AP1104	AP1105	AP1106	T-9D	P-5	P-6	6.4X12.5X1.6
TDBU2921-3157-2.5	CSTB-3	PT1/4GN	CM6X16	AP1101	AP1102	AP1103	AP1104	AP1105	AP1106	T-9D	P-5	P-6	6.4X12.5X1.6

Cartridge set

SPARE PARTS

Designation	⑤ Insert screw	Wrench
TDSCA57-62	CSTB-3	T-9F
TDSCA63-66	CSTB-3	T-9F
TDSCA67-73	CSTB-4	T-15F
TDSCA74-80	CSTB-5	T-20F

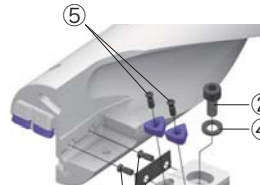

Individual cartridge

Inner cartridge SPARE PARTS

Designation	Clamp screw for insert (X2)	Clamp screw for setting plate
TDS08CA-C-57-62	CSTB-3	-
TDS08CA-C-63-66	CSTB-3	-
TDS09CA-C-67-73	CSTB-4	-
TDS11CA-C-74-80	CSTB-5	-

Outer cartridge SPARE PARTS

Designation	Clamp screw for insert (X2)	Clamp screw for setting plate (X2)
TDS08CA-P-57-62	CSTB-3	CSTB-3
TDS08CA-P-63-66	CSTB-3	CSTB-3
TDS09CA-P-67-73	CSTB-4	CSTB-3
TDS11CA-P-74-80	CSTB-5	CSTB-3

Reference pages

Inserts → E089, Standard cutting conditions → E090

INSERT

DJ

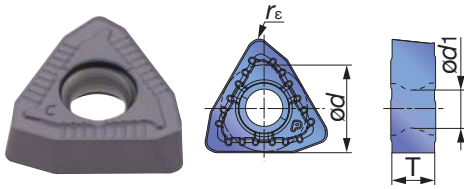

Designation	AH9030	ød (in)	T (in)	ød1 (in)	rε (in)	øDc (in)
WWMU08X408R-DJ	●	0.315	0.154	0.134	0.031	ø2.250 - ø2.579
WWMU09X510R-DJ	●	0.382	0.193	0.173	0.039	ø2.632 - ø2.868
WWMU11X512R-DJ	●	0.445	0.224	0.217	0.047	ø2.921 - ø3.157

DS

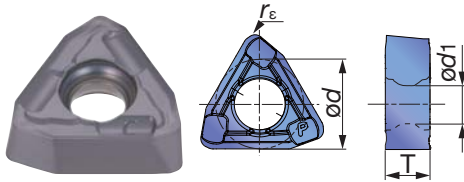

Designation	AH6030	ød (in)	T (in)	ød1 (in)	rε (in)	øDc (in)
WWMU08X408R-DS	●	0.315	0.154	0.134	0.031	ø2.250 - ø2.579
WWMU09X510R-DS	●	0.382	0.193	0.173	0.039	ø2.632 - ø2.868
WWMU11X512R-DS	●	0.445	0.224	0.217	0.047	ø2.921 - ø3.157



Indexable Drill

● : Line up

STANDARD CUTTING CONDITIONS



Indexable Drill

ISO	Workpiece material	Selection criteria	Chip-breaker	Grade	Cutting speed Vc (sfm)	Feed: f (ipr)	
						øDc (in)	
						ø2.250 - 2.868	ø2.921 - 3.157
P	Low carbon steels (C<0.3) 1018, 1020, 1026, etc.	First choice	DS	AH6030	525 - 1050	0.0015 - 0.004	0.0015 - 0.004
		For wear resistance	DJ	AH9030	525 - 820	0.0015 - 0.004	0.0015 - 0.004
	Carbon steels (C>0.3) 1045, 1055, etc.	First choice	DJ	AH9030	260 - 820	0.002 - 0.007	0.002 - 0.008
		For impact resistance	DS	AH6030	260 - 820	0.002 - 0.006	0.002 - 0.006
	Low alloy steels 5120, etc.	First choice	DS	AH6030	260 - 660	0.0015 - 0.005	0.0015 - 0.005
		For wear resistance	DJ	AH9030	260 - 660	0.002 - 0.006	0.002 - 0.006
	Alloy steels 4140, 8620, etc.	First choice	DJ	AH9030	330 - 660	0.002 - 0.007	0.002 - 0.008
		For impact resistance	DS	AH6030	260 - 660	0.0015 - 0.006	0.0015 - 0.006
M	Stainless steels (Austenitic) 304SS, 316SS, etc.	First choice	DS	AH6030	330 - 660	0.0015 - 0.005	0.0015 - 0.005
		—	DJ	AH9030	330 - 660	0.0015 - 0.005	0.0015 - 0.005
	Stainless steels (Martensitic and ferritic) 430SS, 416SS, etc.	First choice	DS	AH6030	330 - 660	0.0015 - 0.005	0.0015 - 0.005
		—	DJ	AH9030	330 - 660	0.0015 - 0.005	0.0015 - 0.005
	Stainless steels (Precipitation hardening) 17-4 PH, etc.	First choice	DS	AH6030	260 - 400	0.0015 - 0.004	0.0015 - 0.004
		—	DJ	AH9030	260 - 400	0.0015 - 0.004	0.0015 - 0.004
K	Gray cast irons Class 25, Class 30, etc.	First choice	DJ	AH9030	260 - 820	0.002 - 0.008	0.002 - 0.009
		For impact resistance	DS	AH6030	260 - 660	0.002 - 0.006	0.002 - 0.007
	Ductile cast irons 60-40-18, 60-55-06, etc.	First choice	DJ	AH9030	260 - 660	0.002 - 0.007	0.002 - 0.008
		For impact resistance	DS	AH6030	260 - 500	0.002 - 0.006	0.002 - 0.007
N	Non ferrous material 6061, 7075, etc.	First choice	DS	AH6030	660 - 1300	0.004 - 0.009	0.004 - 0.010
		—	DJ	AH9030	660 - 1300	0.004 - 0.009	0.004 - 0.010
S	Heat-resistant alloy Inconel718, etc.	First choice	DS	AH6030	60 - 200	0.0015 - 0.004	0.0015 - 0.004
		—	DJ	AH9030	60 - 200	0.0015 - 0.004	0.0015 - 0.004
	Titanium alloy Ti-6Al-4V, etc.	First choice	DS	AH6030	130 - 400	0.002 - 0.006	0.002 - 0.006
		—	DJ	AH9030	130 - 400	0.002 - 0.006	0.002 - 0.006
H	Hardened material Over 40HRC	First choice	DJ	AH9030	170 - 330	0.0015 - 0.004	0.0015 - 0.004
		For impact resistance	DS	AH6030	130 - 260	0.0015 - 0.004	0.0015 - 0.004

Caution

Machine

- Use drills on a fully covered machine to maintain safety.
- Use drills on a high powered machine such as a CAT50.
- Figure on right shows reference of required machine power.

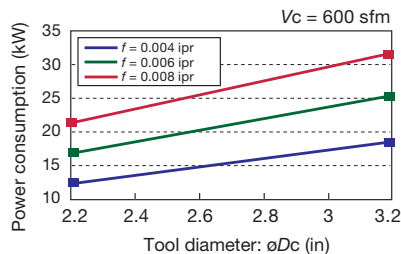

Cutting coolant

- Use water soluble type coolant
- with internal supply.
- Coolant pressure higher than 1MPa is essential.

TDB, TDX cartridge set

L/D = 2.5, dia. $\varnothing 2.250''$ - $\varnothing 3.157''$, diameter adjustable with setting plate

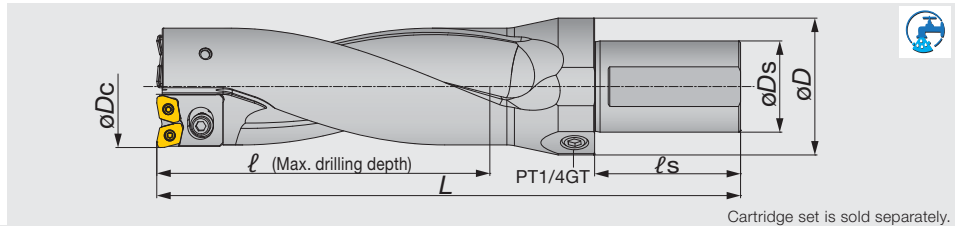

Body	Cartridge set	$\varnothing D_c$	$\varnothing D_s$	$\varnothing D$	ℓ	ℓ_s	L	lb	Setting plate		Insert
Inch	Inch								Designation	Thickness	
TDBU2250-2447-2.5	TDXCA57-62	2.250	2.0	2.953	6.117	4.0	11.874	8.8	-	-	XPMT08T308R-D*
TDBU2250-2447-2.5	TDXCA57-62	2.289	2.0	2.953	6.117	4.0	11.874	8.8	AP0801	0.020	XPMT08T308R-D*
TDBU2250-2447-2.5	TDXCA57-62	2.329	2.0	2.953	6.117	4.0	11.874	8.8	AP0802	0.039	XPMT08T308R-D*
TDBU2250-2447-2.5	TDXCA57-62	2.368	2.0	2.953	6.117	4.0	11.874	8.8	AP0803	0.059	XPMT08T308R-D*
TDBU2250-2447-2.5	TDXCA57-62	2.407	2.0	2.953	6.117	4.0	11.874	8.8	AP0804	0.079	XPMT08T308R-D*
TDBU2250-2447-2.5	TDXCA57-62	2.447	2.0	2.953	6.117	4.0	11.874	8.8	AP0805	0.098	XPMT08T308R-D*
TDBU2461-2579-2.5	TDXCA63-66	2.461	2.0	2.953	6.447	4.0	12.465	10.1	-	-	XPMT08T308R-D*
TDBU2461-2579-2.5	TDXCA63-66	2.500	2.0	2.953	6.447	4.0	12.465	10.1	AP0801	0.020	XPMT08T308R-D*
TDBU2461-2579-2.5	TDXCA63-66	2.539	2.0	2.953	6.447	4.0	12.465	10.1	AP0802	0.039	XPMT08T308R-D*
TDBU2461-2579-2.5	TDXCA63-66	2.579	2.0	2.953	6.447	4.0	12.465	10.1	AP0803	0.059	XPMT08T308R-D*
TDBU2632-2868-2.5	TDXCA67-73	2.632	2.0	2.953	7.170	4.0	13.449	11.9	-	-	XPMT110412R-D*
TDBU2632-2868-2.5	TDXCA67-73	2.671	2.0	2.953	7.170	4.0	13.449	11.9	AP1101	0.020	XPMT110412R-D*
TDBU2632-2868-2.5	TDXCA67-73	2.711	2.0	2.953	7.170	4.0	13.449	11.9	AP1102	0.039	XPMT110412R-D*
TDBU2632-2868-2.5	TDXCA67-73	2.750	2.0	2.953	7.170	4.0	13.449	11.9	AP1103	0.059	XPMT110412R-D*
TDBU2632-2868-2.5	TDXCA67-73	2.789	2.0	2.953	7.170	4.0	13.449	11.9	AP1104	0.079	XPMT110412R-D*
TDBU2632-2868-2.5	TDXCA67-73	2.829	2.0	2.953	7.170	4.0	13.449	11.9	AP1105	0.098	XPMT110412R-D*
TDBU2632-2868-2.5	TDXCA67-73	2.868	2.0	2.953	7.170	4.0	13.449	11.9	AP1106	0.118	XPMT110412R-D*
TDBU2921-3157-2.5	TDXCA74-80	2.921	2.0	2.953	7.894	4.0	13.843	13.7	-	-	XPMT110412R-D*
TDBU2921-3157-2.5	TDXCA74-80	2.961	2.0	2.953	7.894	4.0	13.843	13.7	AP1101	0.020	XPMT110412R-D*
TDBU2921-3157-2.5	TDXCA74-80	3.000	2.0	2.953	7.894	4.0	13.843	13.7	AP1102	0.039	XPMT110412R-D*
TDBU2921-3157-2.5	TDXCA74-80	3.039	2.0	2.953	7.894	4.0	13.843	13.7	AP1103	0.059	XPMT110412R-D*
TDBU2921-3157-2.5	TDXCA74-80	3.079	2.0	2.953	7.894	4.0	13.843	13.7	AP1104	0.079	XPMT110412R-D*
TDBU2921-3157-2.5	TDXCA74-80	3.118	2.0	2.953	7.894	4.0	13.843	13.7	AP1105	0.098	XPMT110412R-D*
TDBU2921-3157-2.5	TDXCA74-80	3.157	2.0	2.953	7.894	4.0	13.843	13.7	AP1106	0.118	XPMT110412R-D*

Body

SPARE PARTS



Designation	① Setting plate screw	Plug	② Cartridge screw	③ Setting plate	③ Setting plate 1	③ Setting plate 2	③ Setting plate 3	③ Setting plate 4	③ Setting plate 5	Wrench for setting plate	Wrench for cartridge	Wrench for plug	④ Washer
TDBU2250-2447-2.5	CSTB-3	PT1/4GN	CM5X0.8X12	AP0801	AP0802	AP0803	AP0804	AP0805	-	T-9D	P-4	P-6	5.3X10X1.6
TDBU2461-2579-2.5	CSTB-3	PT1/4GN	CHHM6-15	AP0801	AP0802	AP0803	-	-	-	T-9D	P-5	P-6	6.4X12.5X1.6
TDBU2632-2868-2.5	CSTB-3	PT1/4GN	CM6X16	AP1101	AP1102	AP1103	AP1104	AP1105	AP1106	T-9D	P-5	P-6	6.4X12.5X1.6
TDBU2921-3157-2.5	CSTB-3	PT1/4GN	CM6X16	AP1101	AP1102	AP1103	AP1104	AP1105	AP1106	T-9D	P-5	P-6	6.4X12.5X1.6

Cartridge set

SPARE PARTS



Designation	⑤ Insert screw	Wrench
TDXCA57-62	CSTB-3	T-9F
TDXCA63-66	CSTB-3	T-9F
TDXCA67-73	CSTB-4	T-15F
TDXCA74-80	CSTB-4	T-15F

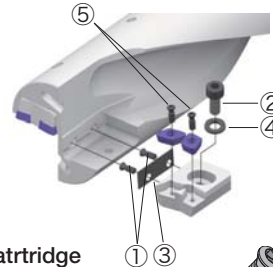

Individual cartridge

Inner cartridge SPARE PARTS



Designation	Clamp screw for insert (X2)	Clamp screw for setting plate
TDX08CA-C1	CSTB-3	-
TDX08CA-C2	CSTB-3	-
TDX11CA-C1	CSTB-4	-
TDX11CA-C2	CSTB-4	-

Outer cartridge SPARE PARTS



Designation	Clamp screw for insert (X2)	Clamp screw for setting plate (X2)
TDX08CA-P1	CSTB-3	CSTB-3
TDX08CA-P2	CSTB-3	CSTB-3
TDX11CA-P1	CSTB-4	CSTB-3
TDX11CA-P2	CSTB-4	CSTB-3

Reference pages

Inserts → E092, Standard cutting conditions → E093

Indexable Drill

INSERT

DJ

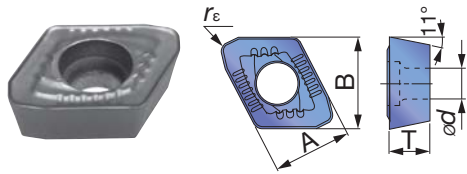

Designation	Coated				A (in)	B (in)	T (in)	ød (in)	rε (in)	øDc (in)
	AH9030	AH6030	AH725	T1115						
XPMT08T308R-DJ	●	●	●	●	0.335	0.390	0.156	0.134	0.031	ø2.250 - ø2.579
XPMT110412R-DJ	●	●	●	●	0.441	0.492	0.187	0.173	0.047	ø2.632 - ø3.157

DS

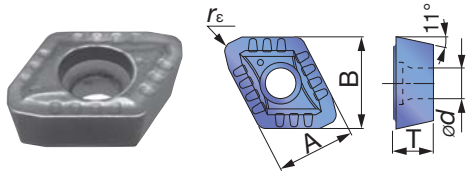

Designation	Coated		A (in)	B (in)	T (in)	ød (in)	rε (in)	øDc (in)
	AH6030	AH725						
XPMT08T308R-DS	●	●	0.335	0.390	0.156	0.134	0.031	ø2.250 - ø2.579
XPMT110412R-DS	●	●	0.441	0.492	0.187	0.173	0.047	ø2.632 - ø3.157

DW

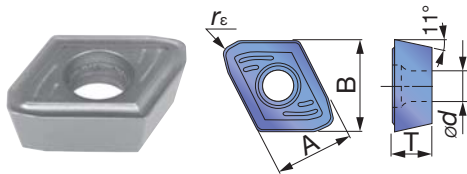

Designation	Coated			A (in)	B (in)	T (in)	ød (in)	rε (in)	øDc (in)
	AH9030	AH6030	AH725						
XPMT08T308R-DW	●	●	●	0.335	0.390	0.156	0.134	0.031	ø2.250 - ø2.579
XPMT110412R-DW	●	●	●	0.441	0.492	0.187	0.173	0.047	ø2.632 - ø3.157

DG

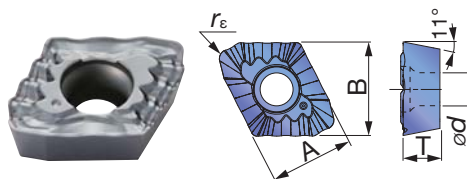

Designation	Coated	A (in)	B (in)	T (in)	ød (in)	rε (in)	øDc (in)
	AH725						
XPMT08T308R-DG	●	0.335	0.390	0.156	0.134	0.031	ø2.250 - ø2.579
XPMT110412R-DG	●	0.441	0.492	0.187	0.173	0.047	ø2.632 - ø3.157

● : Line up

INSERTS RECOMMENDATION

ISO	Workpiece material	First choice	High feed	High speed	Troubleshooting		
					Breakage	Wear	Surface finish
P	Low carbon steels (C < 0.3) 1018, 1020, 1026, etc.	DS, AH725	-	DJ, AH725	DS, AH120	-	DW, AH725
	Carbon steels (C > 0.3) 1045, 1055, etc.	DJ, AH725	DW, AH725	DJ, AH725	DW, AH740	DJ, T1115	DW, AH725
	Low alloy steels 5120, etc.	DS, AH725	-	DJ, AH725	DS, AH120	-	DW, AH725
	Alloy steels 4140, 8620, etc.	DJ, AH725	DW, AH725	DJ, AH725	DW, AH740	DJ, T1115	DW, AH725
M	Stainless steels (Austenitic) 304SS, 316SS, etc.	DS, AH725	-	DS, AH725	DS, AH120	-	DW, AH725
	Stainless steels (Martensitic and ferritic) 430SS, 416SS, etc.	DS, AH725	-	DS, AH725	DS, AH120	-	DW, AH725
	Stainless steels (Precipitation hardening) 17-4 PH, etc.	DS, AH725	-	DS, AH725	DS, AH120	-	DW, AH725
K	Gray cast irons Class 25, Class 30, etc.	DJ, AH725	DW, AH725	DJ, T1115	DW, AH740	DJ, T1115	DW, AH725
	Ductile cast irons 60-40-18, 60-55-06, etc.	DJ, AH725	DW, AH725	DJ, T1115	DW, AH740	DJ, T1115	DW, AH725
N	Non ferrous material 6061, 7075, etc.	DW, AH725	DW, AH725	DJ, AH725	DW, AH740	-	-



Indexable Drill

STANDARD CUTTING CONDITIONS

ISO	Workpiece material	Cutting speed Vc (sfm)	Feed: f (ipr)	
			ø2.250 ~ ø2.579	ø2.632 ~ ø3.157
P	Low carbon steels (C < 0.3) 1018, 1020, 1026, etc.	520 - 1000	0.002 - 0.005	0.003 - 0.006
	Carbon steels (C > 0.3) 1045, 1055, etc.	260 - 820	0.003 - 0.007	0.004 - 0.008
	Low alloy steels 5120, etc.	520 - 820	0.002 - 0.006	0.003 - 0.007
	Alloy steels 4140, 8620, etc.	260 - 660	0.002 - 0.006	0.003 - 0.007
M	Stainless steels (Austenitic) 304SS, 316SS, etc.	330 - 660	0.002 - 0.005	0.003 - 0.006
	Stainless steels (Martensitic and ferritic) 430SS, 416SS, etc.	330 - 660	0.002 - 0.005	0.003 - 0.006
	Stainless steels (Precipitation hardening) 17-4 PH, etc.	260 - 390	0.002 - 0.004	0.002 - 0.005
K	Gray cast irons Class 25, Class 30, etc.	260 - 820	0.003 - 0.008	0.004 - 0.009
	Ductile cast irons 60-40-18, 60-55-06, etc.	260 - 660	0.003 - 0.008	0.004 - 0.009
N	Non ferrous material 6061, 7075, etc.	660 - 1300	0.006 - 0.010	0.007 - 0.110

STANDARD CUTTING CONDITIONS FOR DG CHIPBREAKER

ISO	Workpiece material	Cutting speed Vc (sfm)	Feed: f (ipr)
			ø2.250 ~ ø3.157
P	Low carbon steels (C < 0.3) 1018, 1020, 1026, etc.	200 - 580	0.002 - 0.003

Caution

Machine

- Use drills on a fully covered machine to maintain safety.
- Use drills on a high powered machine such as a CAT50.
- Figure on right shows reference of required machine power.

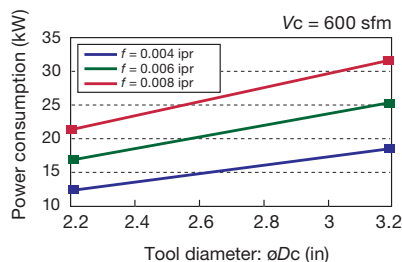

Cutting coolant

- Use water soluble type coolant with internal supply.
- Coolant pressure higher than 1MPa is essential.

Other Drilling Inserts

● LPMT03X206R-D4, LPMT05X204-D4

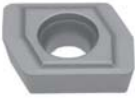
Shape	Designation	Coated			Applicable drill diameter (mm)	Applicable drill
		T313W				
	LPMT03X206R-D4	●			ø14 ~ ø17.5 (ø0.551" ~ ø0.689")	TDJ (Former products)
	LPMT05X204-D4	●			ø14 ~ ø17.5 (ø0.551" ~ ø0.689")	

● SPMP831DS, SPMP/M**2ERD

Shape	Designation	ISO Metric Designation	Coated			Applicable drill diameter (mm)	Applicable drill
			T313W				
	SPMP831DS	SPMT060204-DS	●			ø18 ~ ø19.5 (ø0.709" ~ ø0.768")	TDR (Former products)
	SPMP042ERD	SPMP080308ER-D	●			ø20 ~ ø28.5 (ø0.787" ~ ø1.122")	
	SPMM322ERD	SPMT090308ER-D	●			ø29 ~ ø34.5 (ø1.142" ~ ø1.358")	
	SPMM432ERD	SPMT120408ER-D	●			ø35 ~ ø49 (ø1.378" ~ ø1.929")	

● TPMP**ZDS, TPMP**ZERD, TPMM**ZERD

Shape	Designation	Coated			Applicable drill diameter (mm)	Applicable drill
		T313W				
	TPMP83ZDS	●			ø18 ~ ø19.5 (ø0.709" ~ ø0.768")	TDR (Former products)
	TPMP04ZERD	●			ø20 ~ ø28.5 (ø0.787" ~ ø1.122")	
	TPMM32ZERD	●			ø29 ~ ø34.5 (ø1.142" ~ ø1.358")	
	TPMM43ZERD	●			ø35 ~ ø54 (ø1.378" ~ ø2.126")	

● WCMT**-D...

Shape	Designation	Coated			Applicable drill
		AH120	AH140	T313W	
	WCMT050308-DC			●	For boring and Drills (Former products)
	WCMT050308-D4	●	●	●	
	WCMT06T308-DC			●	
	WCMT06T308-D4	●	●	●	
	WCMT080412-DC			●	
	WCMT080412-D4			●	

● : Line up







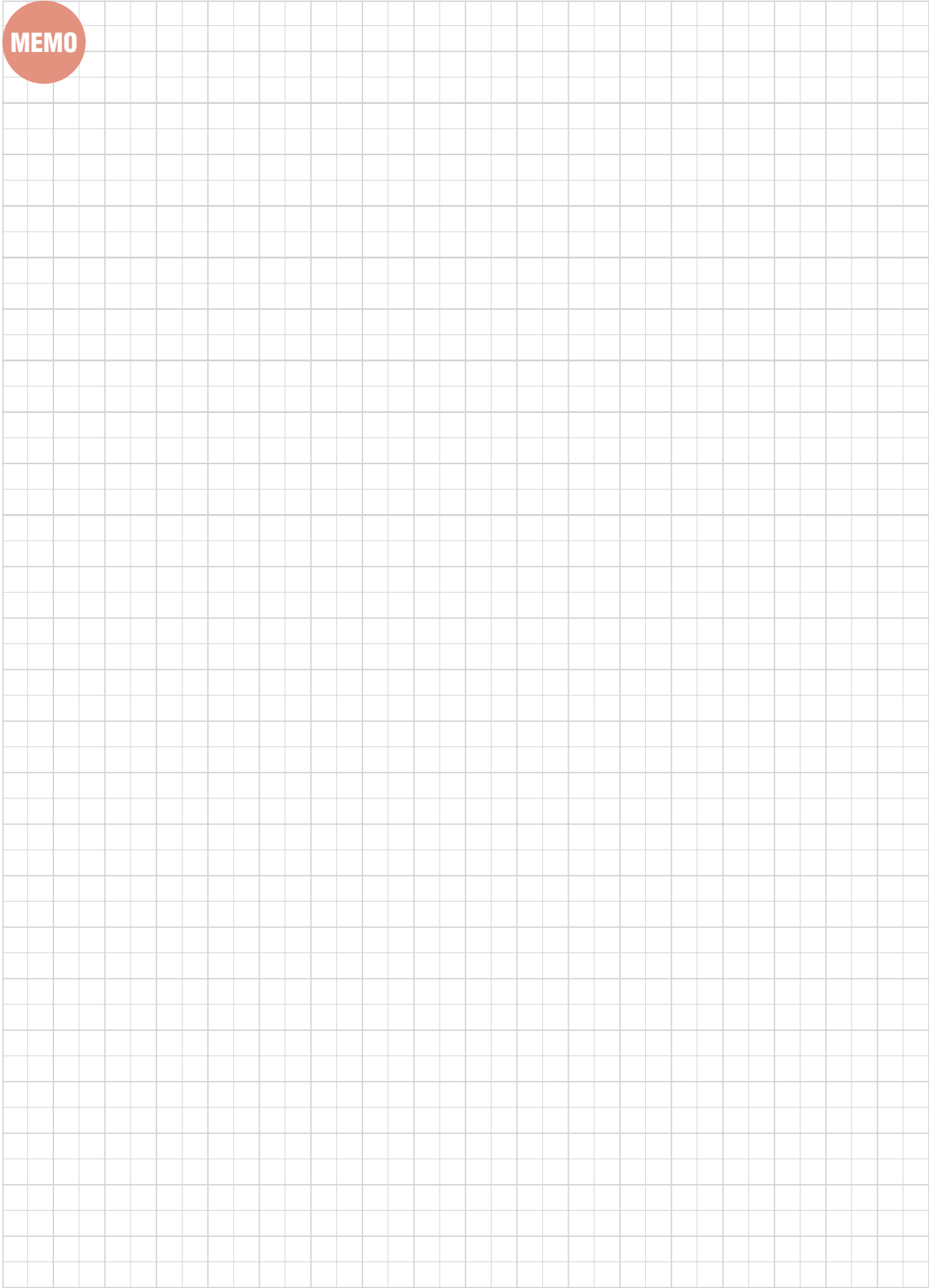



Indexable Drill

MEMO

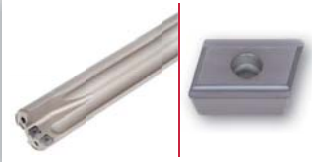

Indexable Drill

DrillLine - Deep Hole Drill

				Inch	Metric
	<p>DEEPT^{RI}DRILL <u>E098</u></p> <p>Excellent productivity and stability in deep hole drilling</p> <p> $\varnothing 0.551'' - 1.102''$ ($\varnothing 14 \text{ mm} - \varnothing 28 \text{ mm}$) / L/D = 10, 15, 25: for Machining centers OAL < 59.055" (1500 mm) : for Gundrill machines (Standard line ups)</p>	<input checked="" type="checkbox"/>	<input checked="" type="checkbox"/>		
	<p>GUNDRILL <u>E112</u></p> <p>Brazed gundrills suitable for small and deep hole drilling</p> <p> Tool dia.: $\varnothing 3 \text{ mm} - \varnothing 12.2 \text{ mm}$ ($\varnothing 0.118'' - \varnothing 0.480''$) OAL $\leq 1650 \text{ mm}$ (64") (Standard line ups)</p>	<input type="checkbox"/>	<input checked="" type="checkbox"/>		
	<p>BTA tools for deep hole drilling <u>E115</u></p> <p>Single and Double tube type. New solution for deep hole drilling</p> <p> $\varnothing 8 \text{ mm} - \varnothing 249 \text{ mm}$ ($\varnothing 0.315'' - \varnothing 9.803''$) TAILOREDTOOL</p>	<input type="checkbox"/>	<input checked="" type="checkbox"/>		
	<p>HF drills for deep hole drilling <u>E117</u></p> <p>Indexable deep hole drills for large diameter with high productivity drilling</p> <p> $\varnothing 30 \text{ mm} - \varnothing 69 \text{ mm}$ ($\varnothing 1.181'' - \varnothing 2.717''$) / Drilling depth: L/D ≤ 14 TAILOREDTOOL</p>	<input type="checkbox"/>	<input checked="" type="checkbox"/>		



DeepTri-Drill

Tungaloy E097

DESIGNATION FOR STANDARD AND TAILOR MADE TOOLS - MCTR TYPE

When a specially designed tool is needed, use the below guide line to make the designation (Cat. No).



1 Series		2 Drill dia. ϕD_c (mm)		3 Driver dia. ϕD_s (mm)		4 L/D ratio	
MCTR	DeepTriDrill (For machining centers and lathes)	16.50	$\phi 16.50$	25	$\phi 25$		



DEEPT^{RI} DRILL

MCTR L/D=10

Drill body for lathes and machining centers, L/D = 10, Tool dia. $\varnothing 0.630'' - \varnothing 1.102''$

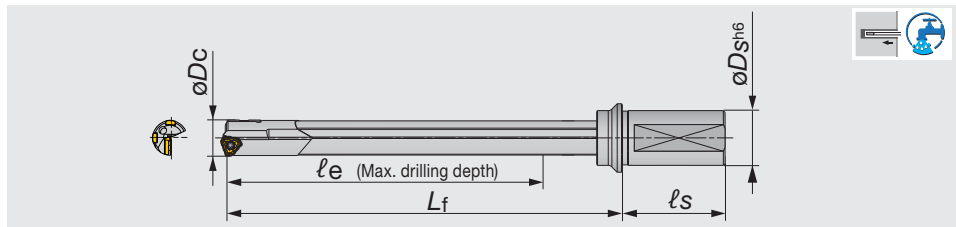

Inch	$\varnothing D_c$	$\varnothing D_s$	ℓ_e	ℓ_s	L_f	Insert	Guide pad
MCTR17.45XU25.4A-10	0.687	1.000	7.087	2.205	8.661	TOHT08	GP05-075
MCTR18.24XU25.4-10	0.718	1.000	7.480	2.205	9.134	TOHT09	GP06-085
MCTR18.64XU25.4-10	0.734	1.000	7.480	2.205	9.134	TOHT09	GP06-085
MCTR19.05XU25.4-10	0.750	1.000	7.874	2.205	9.567	TOHT09	GP06-085
MCTR19.94XU31.75-10	0.785	1.250	8.268	2.362	10.039	TOHT09	GP06-085
MCTR20.62XU31.75-10	0.812	1.250	8.268	2.362	10.039	TOHT10	GP06-085
MCTR22.23XU31.75-10	0.875	1.250	9.055	2.362	10.945	TOHT11	GP06-100
MCTR23.80XU31.75-10	0.937	1.250	9.843	2.362	11.850	TOHT11	GP06-100
MCTR25.40XU31.75-10	1.000	1.250	10.236	2.362	12.283	TOHT12	GP06

$\varnothing D_c$	Tool diameter tolerance	Hole diameter tolerance*
$\varnothing 0.687 - \varnothing 1.000$	0 / - 0.003	+ 0.002 / - 0.004

*Just for reference

SPARE PARTS

Designation	Insert		Guide pad	
	Screw	Wrench	Screw	Wrench
MCTR17.45...	SR14-560/S	T-8F	SR34-508	T-7F
MCTR18.24... - MCTR19.94...	SR14-560/S	T-8F	SR34-508	T-7F
MCTR20.62...	SR34-506	T-9F	SR34-508	T-7F
MCTR22.23... - MCTR23.80...	SR14-571/S	T-10/5	SR34-508	T-7F
MCTR25.40...	SR14-506	T-15F	SR34-508	T-7F

Metric	$\varnothing D_c$ (in)	$\varnothing D_c$ (mm)	$\varnothing D_s$	ℓ_e	ℓ_s	L_f	Insert	Guide pad
MCTR16.00XM25-10	0.630	16	25	170	56	209	TOHT08...	GP06-075
MCTR16.50XM25-10	0.650	16.5	25	170	56	209	TOHT08...	GP06-075
MCTR17.00XM25-10	0.669	17	25	180	56	220	TOHT08...	GP06-075
MCTR18.00XM25-10	0.709	18	25	190	56	232	TOHT08...	GP06-075
MCTR19.00XM25-10	0.748	19	25	200	56	243	TOHT09...	GP06-085
MCTR20.00XM32-10	0.787	20	32	210	60	255	TOHT09...	GP06-085
MCTR21.00XM32-10	0.827	21	32	220	60	266	TOHT10...	GP06-085
MCTR22.00XM32-10	0.866	22	32	230	60	278	TOHT11...	GP06-100
MCTR23.00XM32-10	0.906	23	32	240	60	289	TOHT11...	GP06-100
MCTR24.00XM32-10	0.945	24	32	250	60	301	TOHT11...	GP06-100
MCTR25.00XM32-10	0.984	25	32	260	60	312	TOHT11...	GP06-100
MCTR26.00XM40-10	1.024	26	40	270	70	324	TOHT12...	GP06
MCTR27.00XM40-10	1.063	27	40	280	70	335	TOHT12...	GP06
MCTR28.00XM40-10	1.102	28	40	280	70	337	TOHT12...	GP06

$\varnothing D_c$	Tool diameter tolerance	Hole diameter tolerance*
$\varnothing 16 - \varnothing 28$	0 / - 0.07	+ 0.05 / - 0.1

*Just for reference

SPARE PARTS

Designation	Insert		Guide pad	
	Screw	Wrench	Screw	Wrench
MCTR16... - MCTR18...	CSTB2.5S	T-8F	SR34-508	T-7F
MCTR19... - MCTR20...	SR14-560/S	T-8F	SR34-508	T-7F
MCTR21...	SR34-506	T-9F	SR34-508	T-7F
MCTR22... - MCTR25...	SR14-571/S	T-10/5	SR34-508	T-7F
MCTR26... - MCTR28...	SR14-506	T-15F	SR34-508	T-7F

Reference pages

Inserts → E109, Standard cutting conditions → E110

Deep Hole Drill

DEEPT^{RI} DRILL

MCTR L/D=15

Drill body for lathes and machining centers, L/D = 15, Tool dia. $\varnothing 0.630''$ - $\varnothing 1.102''$

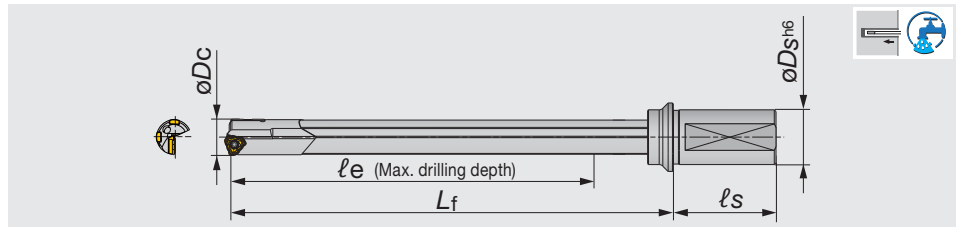

Inch	$\varnothing D_c$	$\varnothing D_s$	ℓ_e	ℓ_s	L_f	Insert	Guide pad
MCTR17.45XU25.4A-15	0.687	1.000	10.630	2.205	12.205	TOHT08	GP05-075
MCTR18.24XU25.4-15	0.718	1.000	11.220	2.205	12.874	TOHT09	GP06-085
MCTR18.64XU25.4-15	0.734	1.000	11.220	2.205	12.874	TOHT09	GP06-085
MCTR19.05XU25.4-15	0.750	1.000	11.811	2.205	13.504	TOHT09	GP06-085
MCTR19.94XU31.75-15	0.785	1.250	12.402	2.362	14.173	TOHT09	GP06-085
MCTR20.62XU31.75-15	0.812	1.250	12.402	2.362	14.173	TOHT10	GP06-085
MCTR22.23XU31.75-15	0.875	1.250	13.583	2.362	15.472	TOHT11	GP06-100
MCTR23.80XU31.75-15	0.937	1.250	14.764	2.362	16.772	TOHT11	GP06-100
MCTR25.40XU31.75-15	1.000	1.250	15.354	2.362	17.402	TOHT12	GP06

$\varnothing D_c$	Tool diameter tolerance	Hole diameter tolerance*
$\varnothing 0.687 - \varnothing 1.000$	0 / - 0.003	+ 0.002 / - 0.004

*Just for reference

SPARE PARTS

Designation	Insert		Guide pad	
	Screw	Wrench	Screw	Wrench
MCTR17.45...	SR14-560/S	T-8F	SR34-508	T-7F
MCTR18.24... - MCTR19.94...	SR14-560/S	T-8F	SR34-508	T-7F
MCTR20.62...	SR34-506	T-9F	SR34-508	T-7F
MCTR22.23... - MCTR23.80...	SR14-571/S	T-10/5	SR34-508	T-7F
MCTR25.40...	SR14-506	T-15F	SR34-508	T-7F

Metric	$\varnothing D_c$ (in)	$\varnothing D_c$ (mm)	$\varnothing D_s$	ℓ_e	ℓ_s	L_f	Insert	Guide pad
MCTR14.00XM25-15	0.551	14	25	225	56	261	TOHT07...	GP05-060
MCTR14.50XM25-15	0.571	14.5	25	225	56	262	TOHT07...	GP05-060
MCTR15.00XM25-15	0.591	15	25	240	56	278	TOHT07...	GP05-060
MCTR16.00XM25-15	0.630	16	25	255	56	294	TOHT08...	GP06-075
MCTR16.50XM25-15	0.650	16.5	25	255	56	294	TOHT08...	GP06-075
MCTR17.00XM25-15	0.669	17	25	270	56	310	TOHT08...	GP06-075
MCTR17.50XM25-15	0.689	17.5	25	270	56	310	TOHT08...	GP06-075
MCTR18.00XM25-15	0.709	18	25	285	56	327	TOHT08...	GP06-075
MCTR18.50XM25-15	0.728	18.5	25	285	56	327	TOHT09...	GP06-085
MCTR19.00XM25-15	0.748	19	25	300	56	343	TOHT09...	GP06-085
MCTR19.50XM25-15	0.768	19.5	25	300	56	343	TOHT09...	GP06-085
MCTR20.00XM32-15	0.787	20	32	315	60	360	TOHT09...	GP06-085
MCTR21.00XM32-15	0.827	21	32	330	60	376	TOHT10...	GP06-085
MCTR22.00XM32-15	0.866	22	32	345	60	393	TOHT11...	GP06-100
MCTR23.00XM32-15	0.906	23	32	360	60	409	TOHT11...	GP06-100
MCTR24.00XM32-15	0.945	24	32	375	60	426	TOHT11...	GP06-100
MCTR25.00XM32-15	0.984	25	32	390	60	442	TOHT11...	GP06-100
MCTR26.00XM40-15	1.024	26	40	405	70	459	TOHT12...	GP06
MCTR27.00XM40-15	1.063	27	40	420	70	475	TOHT12...	GP06
MCTR28.00XM40-15	1.102	28	40	420	70	477	TOHT12...	GP06

$\varnothing D_c$	Tool diameter tolerance	Hole diameter tolerance*
$\varnothing 14 - \varnothing 28$	0 / - 0.07	+ 0.05 / - 0.1

*Just for reference

SPARE PARTS

Designation	Insert		Guide pad	
	Screw	Wrench	Screw	Wrench
MCTR14... - MCTR15...	SR14-560/S	T-8F	SR34-508	T-7F
MCTR16... - MCTR18.0...	CSTB2.5S	T-8F	SR34-508	T-7F
MCTR18.5... - MCTR20...	SR14-560/S	T-8F	SR34-508	T-7F
MCTR21...	SR34-506	T-9F	SR34-508	T-7F
MCTR22... - MCTR25...	SR14-571/S	T-10/5	SR34-508	T-7F
MCTR26... - MCTR28...	SR14-506	T-15F	SR34-508	T-7F

Reference pages

Inserts → **E109**, Standard cutting conditions → **E110**

DEEPT^{RI} DRILL

MCTR L/D=20

Drill body for lathes and machining centers, L/D = 20, Tool diameter $\phi 14 - \phi 15$ mm

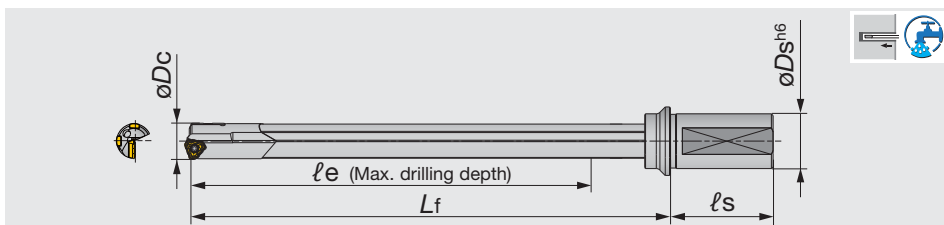

Metric	ϕD_c (in)	ϕD_c (mm)	ϕD_s	ℓ_e	ℓ_s	L_f	Insert	Guide pad
MCTR14.00XM25-20	0.551	14	25	300	56	336	TOHT07...	GP05-060
MCTR14.50XM25-20	0.571	14.5	25	300	56	337	TOHT07...	GP05-060
MCTR15.00XM25-20	0.591	15	25	320	56	358	TOHT07...	GP05-060

ϕD_c	Tool diameter tolerance	Hole diameter tolerance*
$\phi 14 - \phi 15$	0 / - 0.07	+ 0.05 / - 0.1

*Just for reference

SPARE PARTS

Designation	Insert		Guide pad	
	Screw	Wrench	Screw	Wrench
MCTR14...-MCTR15...	SR14-560/S	T-8F	SR34-508	T-7F

DEEPT^{RI} DRILL

MCTR L/D=25

Drill body for lathes and machining centers, L/D = 25, Tool dia. $\phi 0.630'' - \phi 1.102''$

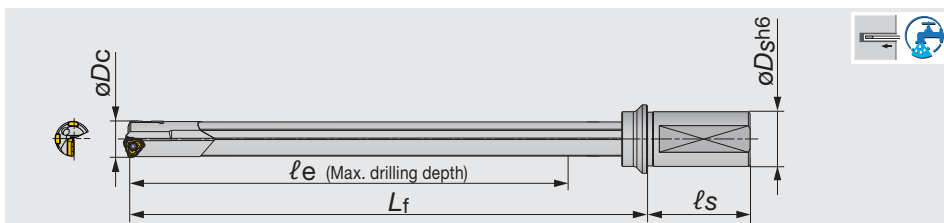

Inch	ϕD_c	ϕD_s	ℓ_e	ℓ_s	L_f	Insert	Guide pad
MCTR17.45XU25.4A-25	0.687	1.000	17.717	2.205	19.291	TOHT08	GP05-075
MCTR18.24XU25.4-25	0.718	1.000	18.701	2.205	20.354	TOHT09	GP06-085
MCTR18.64XU25.4-25	0.734	1.000	18.701	2.205	20.354	TOHT09	GP06-085
MCTR19.05XU25.4-25	0.750	1.000	19.685	2.205	21.378	TOHT09	GP06-085
MCTR19.94XU31.75-25	0.785	1.250	20.669	2.362	22.441	TOHT09	GP06-085
MCTR20.62XU31.75-25	0.812	1.250	20.669	2.362	22.441	TOHT10	GP06-085
MCTR21.46XU31.75-25	0.845	1.250	21.654	2.362	23.465	TOHT10	GP06-100
MCTR22.23XU31.75-25	0.875	1.250	22.638	2.362	24.528	TOHT11	GP06-100
MCTR23.80XU31.75-25	0.937	1.250	24.606	2.362	26.614	TOHT11	GP06-100
MCTR25.40XU31.75-25	1.000	1.250	25.591	2.362	27.638	TOHT12	GP06
MCTR26.97XU38.1-25	1.062	1.500	27.559	2.756	29.724	TOHT12	GP06

ϕD_c	Tool diameter tolerance	Hole diameter tolerance*
$\phi 0.687 - \phi 1.062$	0 / - 0.003	+ 0.002 / - 0.004

*Just for reference

SPARE PARTS

Designation	Insert		Guide pad	
	Screw	Wrench	Screw	Wrench
MCTR17.45...	SR14-560/S	T-8F	SR34-508	T-7F
MCTR18.24... - MCTR19.94...	SR14-560/S	T-8F	SR34-508	T-7F
MCTR20.62... - MCTR21.46...	SR34-506	T-9F	SR34-508	T-7F
MCTR22.23... - MCTR23.80...	SR14-571/S	T-10/5	SR34-508	T-7F
MCTR25.40... - MCTR26.97...	SR14-506	T-15F	SR34-508	T-7F

Reference pages

Inserts → E109, Standard cutting conditions → E110

DEEPT^{RI} DRILL

MCTR L/D=25

Drill body for lathes and machining centers, L/D = 25, Tool dia. $\varnothing 0.630'' - \varnothing 1.102''$

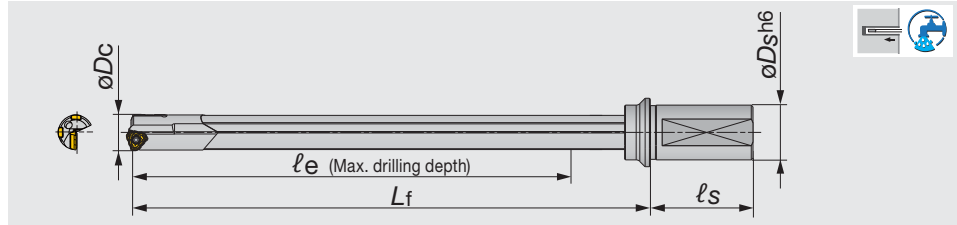

Metric	$\varnothing D_c$ (in)	$\varnothing D_c$ (mm)	$\varnothing D_s$	ℓ_e	ℓ_s	L_f	Insert	Guide pad
MCTR14.00XM25-25	0.551	14	25	375	56	411	TOHT07...	GP05-060
MCTR14.50XM25-25	0.571	14.5	25	375	56	412	TOHT07...	GP05-060
MCTR15.00XM25-25	0.591	15	25	400	56	438	TOHT07...	GP05-060
MCTR16.00XM25-25	0.630	16	25	425	56	464	TOHT08...	GP06-075
MCTR16.50XM25-25	0.650	16.5	25	425	56	464	TOHT08...	GP06-075
MCTR17.00XM25-25	0.669	17	25	450	56	490	TOHT08...	GP06-075
MCTR17.50XM25-25	0.689	17.5	25	450	56	490	TOHT08...	GP06-075
MCTR18.00XM25-25	0.709	18	25	475	56	517	TOHT08...	GP06-075
MCTR18.50XM25-25	0.728	18.5	25	475	56	517	TOHT09...	GP06-085
MCTR19.00XM25-25	0.748	19	25	500	56	543	TOHT09...	GP06-085
MCTR19.50XM25-25	0.768	19.5	25	500	56	543	TOHT09...	GP06-085
MCTR20.00XM32-25	0.787	20	32	525	60	570	TOHT09...	GP06-085
MCTR21.00XM32-25	0.827	21	32	550	60	596	TOHT10...	GP06-085
MCTR22.00XM32-25	0.866	22	32	575	60	623	TOHT11...	GP06-100
MCTR23.00XM32-25	0.906	23	32	600	60	649	TOHT11...	GP06-100
MCTR24.00XM32-25	0.945	24	32	625	60	676	TOHT11...	GP06-100
MCTR25.00XM32-25	0.984	25	32	650	60	702	TOHT11...	GP06-100
MCTR26.00XM40-25	1.024	26	40	675	70	729	TOHT12...	GP06
MCTR27.00XM40-25	1.063	27	40	700	70	755	TOHT12...	GP06
MCTR28.00XM40-25	1.102	28	40	700	70	757	TOHT12...	GP06

$\varnothing D_c$	Tool diameter tolerance	Hole diameter tolerance*
$\varnothing 14 - \varnothing 28$	0 / - 0.07	+ 0.05 / - 0.1

*Just for reference

SPARE PARTS

Designation	Insert		Guide pad	
	Screw	Wrench	Screw	Wrench
MCTR14... - MCTR15...	SR14-560/S	T-8F	SR34-508	T-7F
MCTR16... - MCTR18.0...	CSTB2.5S	T-8F	SR34-508	T-7F
MCTR18.5... - MCTR20...	SR14-560/S	T-8F	SR34-508	T-7F
MCTR21...	SR34-506	T-9F	SR34-508	T-7F
MCTR22... - MCTR25...	SR14-571/S	T-10/5	SR34-508	T-7F
MCTR26... - MCTR28...	SR14-506	T-15F	SR34-508	T-7F

AVAILABLE RANGE OF TAILOR MADE DRILL BODIES

$\varnothing D_c$	$\varnothing D_s$	ℓ_e	ℓ_s	ℓ_1
16 - 16.79	25	136 - 425	56	175 - 464
16.8 - 17.69	25	144 - 450	56	184 - 490
17.7 - 18.69	25	152 - 475	56	194 - 517
18.7 - 19.69	25	160 - 500	56	203 - 543
19.7 - 20.69	32	168 - 525	60	213 - 570
20.7 - 21.69	32	176 - 550	60	222 - 596
21.7 - 22.69	32	184 - 575	60	232 - 623
22.7 - 23.69	32	192 - 600	60	241 - 649
23.7 - 24.69	32	200 - 625	60	251 - 676
24.7 - 25.69	32	208 - 650	60	260 - 702
25.7 - 26.69	40	216 - 675	70	270 - 719
26.7 - 27.69	40	224 - 700	70	279 - 745
27.7 - 28	40	224 - 700	70	281 - 747

(Unit: mm)

Reference pages

Inserts → E109, Standard cutting conditions → E110

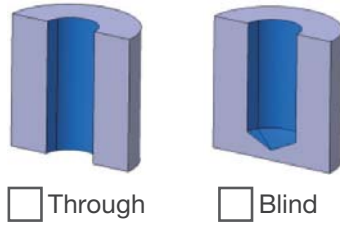
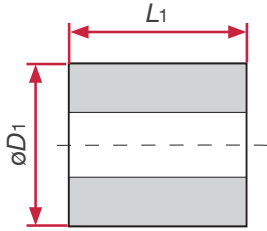

ϕD_1	
L_1	
Hole tolerance	

Request

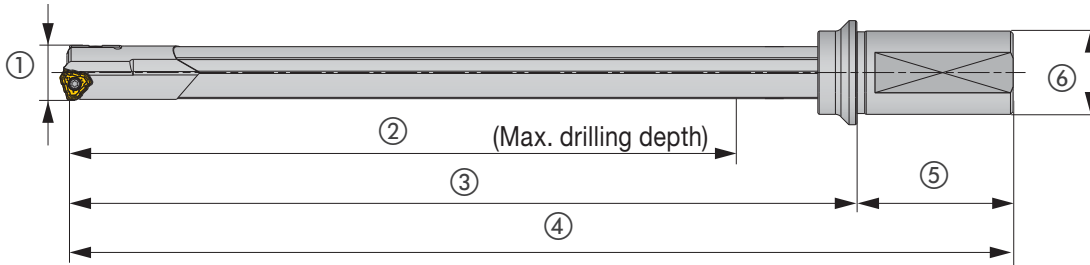

①	
②	
③	

④	
⑤	
⑥	

Description	
Quote QTY	pcs
*MOQ: 1pc	

Technical data

Machine type	<input type="checkbox"/> MCT <input type="checkbox"/> Lathe
	<input type="checkbox"/> Vertical <input type="checkbox"/> Horizontal
Machine name	
Power	Kw
Coolant type	<input type="checkbox"/> Oil <input type="checkbox"/> Water-soluble

Workpiece

Part	
Material	
Hardness	

Driver

Driver	●	ϕD_s		l_s		Driver code	Coverage	
		Inch	Metric	Inch	Metric		Inch	Metric
		0.984	25	2.205	56	M25	$\phi 0.551 - \phi 0.775$	$\phi 14 - \phi 19.69$
		1.260	32	2.362	60	M32	$\phi 0.775 - \phi 1.011$	$\phi 19.7 - \phi 25.69$
		1.575	40	2.756	70	M40	$\phi 1.011 - \phi 1.102$	$\phi 25.7 - \phi 28$
		1.000	25.4	2.205	56	U25.4	$\phi 0.551 - \phi 0.775$	$\phi 14 - \phi 19.69$
		1.250	31.75	2.362	60	U31.75	$\phi 0.775 - \phi 1.011$	$\phi 19.7 - \phi 25.69$
		1.500	38.1	2.756	70	U38.1	$\phi 1.011 - \phi 1.102$	$\phi 25.7 - \phi 28$

- Please check "●" in the list of driver.
- If you need special design, please send us detail information.
- If the drill depth is more than " $\phi D_1 \times 30$ ", you should use 2 types of DeepTriDrill, a short and a long one, because of tool fracture caused by chattering.



DESIGNATION FOR STANDARD AND TAILOR MADE TOOLS - TRLG TYPE

When a specially designed tool is needed, use the below guide line to make the designation (Cat. No).

TRLG	16.50	X	900	-	23
1	2		3		4

1 Series		2 Drill dia. ϕD_c (mm)		3 Overall length: L (mm)		4 Driver code	
TRLG	DeepTriDrill (For gun drill machine)	16.50	$\phi 16.50$	900	900	23	23



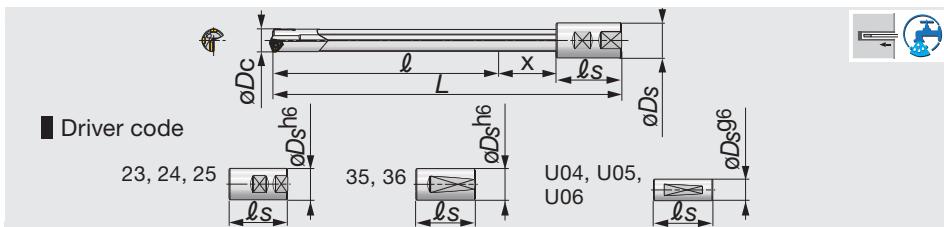

Metric	ϕD_c (in)	ϕD_c (mm)	L	ϕD_s	ℓ	ℓ_s	x	Driver code	Insert	Guide pad
TRLG16.00X800-23	0.630	16	800	25	720	56	24	23	TOHT08...	GP06-075
TRLG16.00X800-U04	0.630	16	800	25.4	706	70	24	U04	TOHT08...	GP06-075
TRLG16.00X800-35	0.630	16	800	25	720	56	24	35	TOHT08...	GP06-075
TRLG16.00X1000-23	0.630	16	1000	25	920	56	24	23	TOHT08...	GP06-075
TRLG16.00X1000-U04	0.630	16	1000	25.4	906	70	24	U04	TOHT08...	GP06-075
TRLG16.00X1000-35	0.630	16	1000	25	920	56	24	35	TOHT08...	GP06-075
TRLG16.00X1500-U04	0.630	16	1500	25.4	1406	70	24	U04	TOHT08...	GP06-075
TRLG16.00X1500-23	0.630	16	1500	25	1420	56	24	23	TOHT08...	GP06-075
TRLG16.00X1500-35	0.630	16	1500	25	1420	56	24	35	TOHT08...	GP06-075
TRLG17.00X800-23	0.669	17	800	25	719	56	25	23	TOHT08...	GP06-075
TRLG17.00X800-U04	0.669	17	800	25.4	705	70	25	U04	TOHT08...	GP06-075
TRLG17.00X1000-23	0.669	17	1000	25	919	56	25	23	TOHT08...	GP06-075
TRLG17.00X1000-U04	0.669	17	1000	25.4	905	70	25	U04	TOHT08...	GP06-075
TRLG17.00X1000-35	0.669	17	1000	25	919	56	25	35	TOHT08...	GP06-075
TRLG17.00X1500-23	0.669	17	1500	25	1419	56	25	23	TOHT08...	GP06-075
TRLG17.00X1500-U04	0.669	17	1500	25.4	1405	70	25	U04	TOHT08...	GP06-075
TRLG17.00X1500-35	0.669	17	1500	25	1419	56	25	35	TOHT08...	GP06-075
TRLG18.00X800-23	0.709	18	800	25	717	56	27	23	TOHT08...	GP06-075
TRLG18.00X800-U04	0.709	18	800	25.4	703	70	27	U04	TOHT08...	GP06-075
TRLG18.00X800-35	0.709	18	800	25	717	56	27	35	TOHT08...	GP06-075
TRLG18.00X1000-23	0.709	18	1000	25	917	56	27	23	TOHT08...	GP06-075
TRLG18.00X1000-U04	0.709	18	1000	25.4	903	70	27	U04	TOHT08...	GP06-075
TRLG18.00X1000-35	0.709	18	1000	25	917	56	27	35	TOHT08...	GP06-075
TRLG18.00X1500-U04	0.709	18	1500	25.4	1403	70	27	U04	TOHT08...	GP06-075
TRLG18.00X1500-23	0.709	18	1500	25	1417	56	27	23	TOHT08...	GP06-075
TRLG18.00X1500-35	0.709	18	1500	25	1417	56	27	35	TOHT08...	GP06-075
TRLG19.00X800-23	0.748	19	800	25	716	56	28	23	TOHT09...	GP06-085
TRLG19.00X800-U04	0.748	19	800	25.4	702	70	28	U04	TOHT09...	GP06-085
TRLG19.00X800-35	0.748	19	800	25	716	56	28	35	TOHT09...	GP06-085
TRLG19.00X1000-23	0.748	19	1000	25	916	56	28	23	TOHT09...	GP06-085
TRLG19.00X1000-U04	0.748	19	1000	25.4	902	70	28	U04	TOHT09...	GP06-085
TRLG19.00X1000-35	0.748	19	1000	25	916	56	28	35	TOHT09...	GP06-085
TRLG19.00X1500-U04	0.748	19	1500	25.4	1402	70	28	U04	TOHT09...	GP06-085
TRLG19.00X1500-23	0.748	19	1500	25	1416	56	28	23	TOHT09...	GP06-085
TRLG19.00X1500-35	0.748	19	1500	25	1416	56	28	35	TOHT09...	GP06-085
TRLG20.00X800-24	0.787	20	800	32	710	60	30	24	TOHT09...	GP06-085
TRLG20.00X800-U05	0.787	20	800	31.75	700	70	30	U05	TOHT09...	GP06-085
TRLG20.00X800-36	0.787	20	800	32	710	60	30	36	TOHT09...	GP06-085
TRLG20.00X1000-24	0.787	20	1000	32	910	60	30	24	TOHT09...	GP06-085
TRLG20.00X1000-U05	0.787	20	1000	31.75	900	70	30	U05	TOHT09...	GP06-085
TRLG20.00X1000-36	0.787	20	1000	32	910	60	30	36	TOHT09...	GP06-085
TRLG20.00X1500-24	0.787	20	1500	32	1410	60	30	24	TOHT09...	GP06-085
TRLG20.00X1500-U05	0.787	20	1500	31.75	1400	70	30	U05	TOHT09...	GP06-085
TRLG20.00X1500-36	0.787	20	1500	32	1410	60	30	36	TOHT09...	GP06-085
TRLG21.00X1000-24	0.827	21	1000	32	909	60	31	24	TOHT10...	GP06-085
TRLG21.00X1000-U05	0.827	21	1000	31.75	899	70	31	U05	TOHT10...	GP06-085
TRLG21.00X1000-36	0.827	21	1000	32	909	60	31	36	TOHT10...	GP06-085
TRLG21.00X1500-24	0.827	21	1500	32	1409	60	31	24	TOHT10...	GP06-085
TRLG21.00X1500-U05	0.827	21	1500	31.75	1399	70	31	U05	TOHT10...	GP06-085
TRLG21.00X1500-36	0.827	21	1500	32	1409	60	31	36	TOHT10...	GP06-085

Reference pages

Inserts → E109, Standard cutting conditions → E110

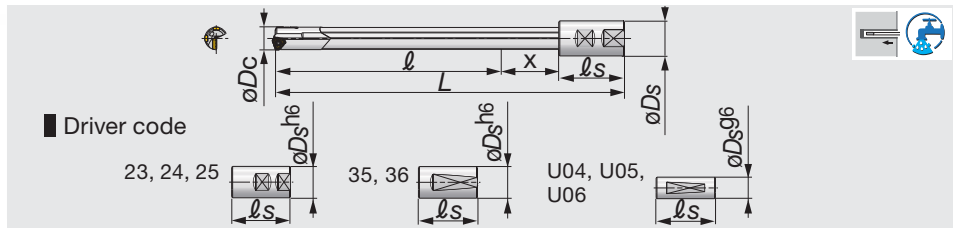

Deep Hole Drill

Metric	ϕD_c (in)	ϕD_c (mm)	L	ϕD_s	ℓ	ℓ_s	x	Driver code	Insert	Guide pad
TRLG22.00X1000-24	0.866	22	1000	32	907	60	33	24	TOHT11...	GP06-100
TRLG22.00X1000-U05	0.866	22	1000	31.75	897	70	33	U05	TOHT11...	GP06-100
TRLG22.00X1000-36	0.866	22	1000	32	907	60	33	36	TOHT11...	GP06-100
TRLG22.00X1500-24	0.866	22	1500	32	1407	60	33	24	TOHT11...	GP06-100
TRLG22.00X1500-U05	0.866	22	1500	31.75	1397	70	33	U05	TOHT11...	GP06-100
TRLG22.00X1500-36	0.866	22	1500	32	1407	60	33	36	TOHT11...	GP06-100
TRLG23.00X1000-24	0.906	23	1000	32	906	60	34	24	TOHT11...	GP06-100
TRLG23.00X1000-U05	0.906	23	1000	31.75	896	70	34	U05	TOHT11...	GP06-100
TRLG23.00X1000-36	0.906	23	1000	32	906	60	34	36	TOHT11...	GP06-100
TRLG23.00X1500-24	0.906	23	1500	32	1406	60	34	24	TOHT11...	GP06-100
TRLG23.00X1500-U05	0.906	23	1500	31.75	1396	70	34	U05	TOHT11...	GP06-100
TRLG23.00X1500-36	0.906	23	1500	32	1406	60	34	36	TOHT11...	GP06-100
TRLG24.00X1000-24	0.945	24	1000	32	904	60	36	24	TOHT11...	GP06-100
TRLG24.00X1000-U05	0.945	24	1000	31.75	894	70	36	U05	TOHT11...	GP06-100
TRLG24.00X1000-36	0.945	24	1000	32	904	60	36	36	TOHT11...	GP06-100
TRLG24.00X1500-24	0.945	24	1500	32	1404	60	36	24	TOHT11...	GP06-100
TRLG24.00X1500-U05	0.945	24	1500	31.75	1394	70	36	U05	TOHT11...	GP06-100
TRLG24.00X1500-36	0.945	24	1500	32	1404	60	36	36	TOHT11...	GP06-100
TRLG25.00X1000-24	0.984	25	1000	32	903	60	37	24	TOHT11...	GP06-100
TRLG25.00X1000-U05	0.984	25	1000	31.75	893	70	37	U05	TOHT11...	GP06-100
TRLG25.00X1000-36	0.984	25	1000	32	903	60	37	36	TOHT11...	GP06-100
TRLG25.00X1500-24	0.984	25	1500	32	1403	60	37	24	TOHT11...	GP06-100
TRLG25.00X1500-U05	0.984	25	1500	31.75	1393	70	37	U05	TOHT11...	GP06-100
TRLG25.00X1500-36	0.984	25	1500	32	1403	60	37	36	TOHT11...	GP06-100
TRLG26.00X1000-25	1.024	26	1000	40	891	70	39	25	TOHT12...	GP06
TRLG26.00X1000-U06	1.024	26	1000	38.1	891	70	39	U06	TOHT12...	GP06
TRLG26.00X1500-25	1.024	26	1500	40	1391	70	39	25	TOHT12...	GP06
TRLG26.00X1500-U06	1.024	26	1500	38.1	1391	70	39	U06	TOHT12...	GP06
TRLG27.00X1000-25	1.063	27	1000	40	890	70	40	25	TOHT12...	GP06
TRLG27.00X1000-U06	1.063	27	1000	38.1	890	70	40	U06	TOHT12...	GP06
TRLG27.00X1500-25	1.063	27	1500	40	1390	70	40	25	TOHT12...	GP06
TRLG27.00X1500-U06	1.063	27	1500	38.1	1390	70	40	U06	TOHT12...	GP06
TRLG28.00X1000-25	1.102	28	1000	40	888	70	42	25	TOHT12...	GP06
TRLG28.00X1000-U06	1.102	28	1000	38.1	888	70	42	U06	TOHT12...	GP06
TRLG28.00X1500-25	1.102	28	1500	40	1388	70	42	25	TOHT12...	GP06
TRLG28.00X1500-U06	1.102	28	1500	38.1	1388	70	42	U06	TOHT12...	GP06

ϕD_c	Tool diameter tolerance	Hole diameter tolerance*
$\phi 16 - \phi 28$	0 / - 0.07	+ 0.05 / - 0.1

*Just for reference

SPARE PARTS

Designation	Insert		Guide pad	
	Screw	Wrench	Screw	Wrench
TRLG16... - TRLG18...	CSTB2.5S	T-8F	SR34-508	T-7F
TRLG18.5... - TRLG20...	SR14-560/S	T-8F	SR34-508	T-7F
TRLG21...	SR34-506	T-9F	SR34-508	T-7F
TRLG22... - TRLG25...	SR14-571/S	T-10/5	SR34-508	T-7F
TRLG26... - TRLG28...	SR14-506	T-15F	SR34-508	T-7F

Reference pages

Inserts → E109, Standard cutting conditions → E110

TAILOR MADE CAPABILITY

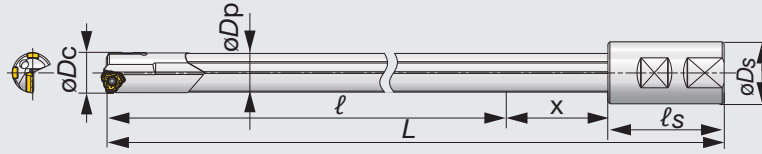

AVAILABLE RANGE OF TAILOR MADE DRILL BODIES

ϕD_c	L	x
16 - 16.79	400 - 2400	24
16.8 - 17.69	400 - 2400	25
17.7 - 18.69	400 - 2400	27
18.7 - 19.69	400 - 2400	28
19.7 - 20.69	400 - 2400	30
20.7 - 21.69	400 - 2400	31
21.7 - 22.69	400 - 2400	33

ϕD_c	L	x
22.7 - 23.69	400 - 2400	34
23.7 - 24.69	400 - 2400	36
24.7 - 25.69	400 - 2400	37
25.7 - 26.69	400 - 2400	39
26.7 - 27.69	400 - 2400	40
27.7 - 28	400 - 2400	42

Please provide the driver shape depending on your request

(Unit: mm)

TUBE DIAMETER

ϕD_c	ϕD_p
16 - 16.79	15.5
16.8 - 17.69	16.2
17.7 - 18.69	17.2
18.7 - 19.69	18.2
19.7 - 20.69	19
20.7 - 21.69	20
21.70 - 22.69	21

ϕD_c	ϕD_p
22.7 - 23.69	22
23.7 - 24.69	23
24.7 - 25.69	24
25.7 - 26.69	25
26.7 - 27.69	26
27.7 - 28	27

(Unit: mm)



Deep Hole Drill

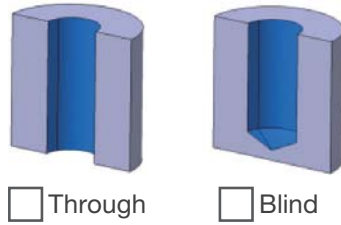
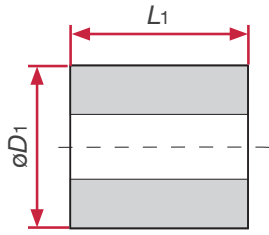

ϕD_1	
L_1	
Holetolerance	

Request

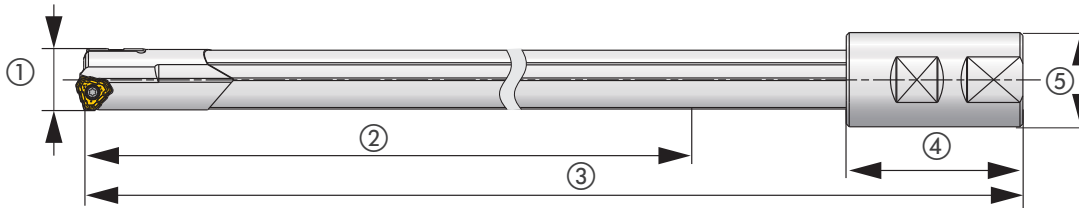

①		④	
②		⑤	
③		⑥	

Description	
Quote QTY	pcs
*MOQ: 1pc	

Technical data

Machine type	<input type="checkbox"/> GM*	<input type="checkbox"/> Lathe
	<input type="checkbox"/> Vertical	<input type="checkbox"/> Horizontal
Machine name		
Power	Kw	
Coolant type	<input type="checkbox"/> Oil	<input type="checkbox"/> Water-soluble

*Gundrill machine

Workpiece

Part	
Material	
Hardness	

Driver

Driver	●	ϕD_s		l_s		Driver code	Coverage	
		Inch	Metric	Inch	Metric		Inch	Metric
		0.984	25	2.205	56	23	$\phi 0.551 - \phi 0.775$	$\phi 14 - \phi 19.69$
		1.260	32	2.362	60	24	$\phi 0.551 - \phi 1.011$	$\phi 14 - \phi 25.69$
		1.260	32	2.756	70	25	$\phi 0.551 - \phi 1.130$	$\phi 14 - \phi 28.69$
		1.969	50	2.756	80	26	$\phi 0.551 - \phi 1.130$	$\phi 14 - \phi 28.69$
		0.984	25	2.205	56	35	$\phi 0.551 - \phi 0.775$	$\phi 14 - \phi 19.69$
		1.260	32	2.362	60	36	$\phi 0.551 - \phi 1.011$	$\phi 14 - \phi 25.69$
		1.000	25.4	2.756	70	U04	$\phi 0.551 - \phi 0.775$	$\phi 14 - \phi 19.69$
		1.250	31.75	2.756	70	U05	$\phi 0.551 - \phi 1.011$	$\phi 14 - \phi 25.69$
		1.500	38.1	2.756	70	U06	$\phi 0.551 - \phi 1.102$	$\phi 14 - \phi 28$

- Please check "●" in the list of driver.
- If you need special design, please send us detail information.
- In case of using machines other than a Gundrill machine, if the drill depth is more than " $\phi D_1 \times 30$ ", you should use 2 types of DeepTriDrill, a short and a long one, because of tool fracture caused by chattering.

INSERT

TOHT-NDJ (080...)

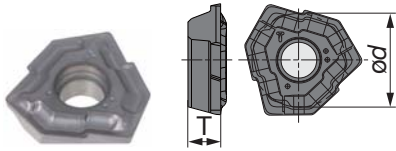

TOHT-NDJ (090... - 120...)

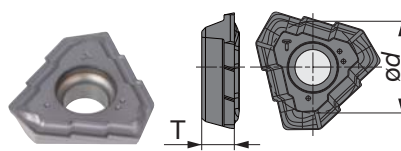

NDJ chipbreaker



- Low cutting force
- For general purpose

Designation	øD _c (mm)	AH725	ød (mm)	T (mm)
TOHT080305R-NDJ	16 - 18	●	8.55	2.8
TOHT090305R-NDJ	18.01 - 20	●	8.32	3
TOHT100305R-NDJ	20.01 - 21.99	●	9.23	3.3
TOHT110405R-NDJ	22 - 25	●	10.4	3.8
TOHT120405R-NDJ	25.01 - 28	●	11.59	4.3

● : Line up
Package quantity = 10 pcs.

GUIDE PAD

GP06

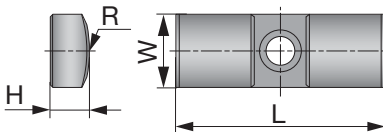

Designation	øD _c (mm)	F1122	F2122	W (mm)	L (mm)	H (mm)	R (mm)
GP06-075	16 - 18	●	●	6	20	3	7.5
GP06-085	18.01 - 21	●	●	6	20	3	8.5
GP06-100	21.01 - 25	●	●	6	20	3	10
GP06	25.01 - 28	●	●	6	20	3	12

● : Line up
Package quantity = 5 pcs.

Replacing guide pads

Guide pads are subject to wear, like inserts

- Each guide pad has 2 corners.
- When the width of wear on the 1st corner reaches 70% of the width of guide pad, reverse the guide pad and use the 2nd corner.
- Replace the guide pad with a new one when the 2nd corner shows the same wear as on the 1st corner.

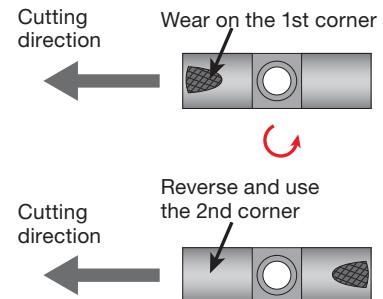
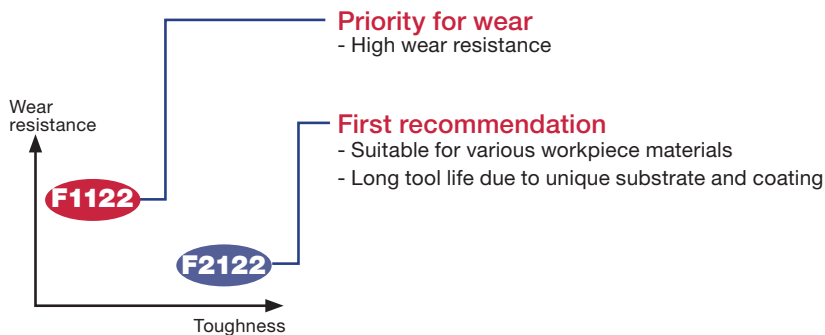

STANDARD CUTTING CONDITIONS

ISO	Workpiece material	Cutting speed Vc (sfm)	Feed f (ipr)
P	Low carbon steel (C < 0.3) 1018, 1020, 1026, etc.	260 - 460	0.002 - 0.004
	Carbon steel (C > 0.3) 1045, 1055, etc.	260 - 460	0.002 - 0.008
	Low alloy steel (C < 0.3) 5120, etc.	260 - 460	0.002 - 0.008
	Alloy steel (C > 0.3) 4140, 8620, etc.	260 - 390	0.002 - 0.008
M	Stainless steel (Austenitic) 304SS, 316SS, etc.	200 - 330	0.002 - 0.004
	Stainless steel (Martensitic, Ferritic) 430SS, 416SS, etc.	200 - 330	0.002 - 0.004
	Stainless steel (Precipitation hardening) 17-4 PH, etc.	200 - 330	0.002 - 0.004
K	Gray cast iron Class 25, Class 30, etc.	260 - 460	0.002 - 0.012
	Ductile cast iron FCD700, etc.	260 - 460	0.002 - 0.012
N	Non ferrous material	330 - 660	0.002 - 0.008
S	Heat-resistant alloys Inconel 718, etc.	70 - 160	0.0016 - 0.004
	Titanium alloys Ti-6Al-4V, etc.	100 - 200	0.002 - 0.006
H	Hardened material ≥ 40HRC	160 - 330	0.0016 - 0.004

Deep Hole Drill

SHAPES OF THE HOLE BOTTOM

ϕD_c	Insert	Maximum difference Hmax
16 - 18	TOHT08	2.166
18.01 - 20	TOHT09	2.965
20.01 - 21.99	TOHT10	3.158
22 - 25	TOHT11	3.383
25.01 - 28	TOHT12	3.63

(Unit: mm)

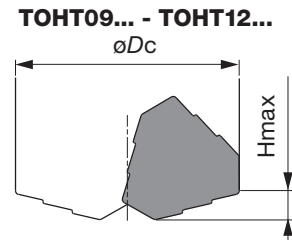
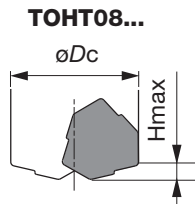

REQUIRED SPINDLE POWER AND COOLANT PRESSURE

Net power

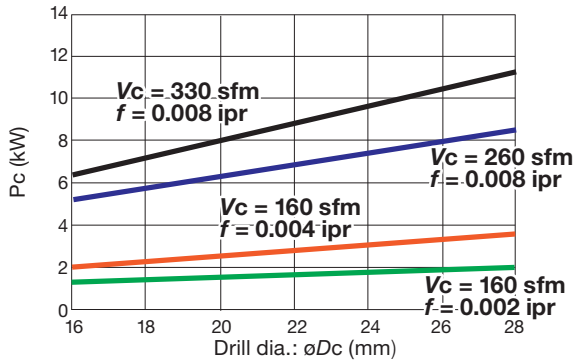

Torque

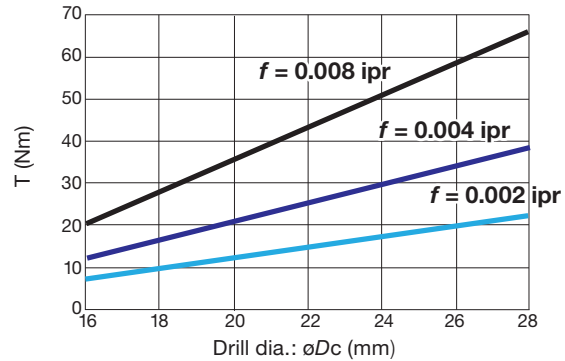

Coolant pressure (Recommended value)

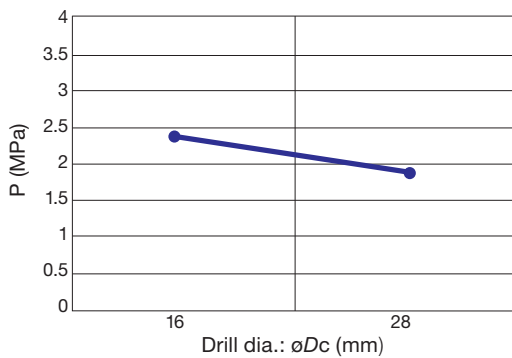

Coolant flow rate (Recommended value)

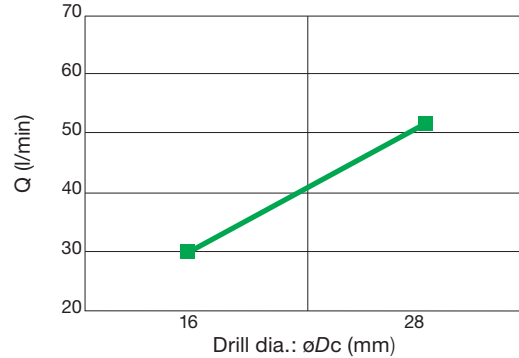

Deep Hole Drill

DRILLING PROCEDURE ON MACHINING CENTERS AND LATHES

Proceed as instructed below in order to maximize the tool performance safely.

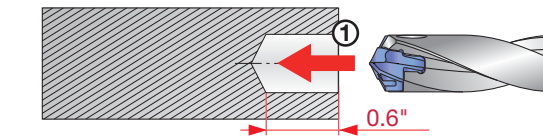

- ① Drill the guide hole
Hole diameter tolerance: $+0.0004'' - +0.004''$
Hole depth: $H = 0.6''$
Please use DrillMeister or TDX + EZ sleeve to make a guide hole

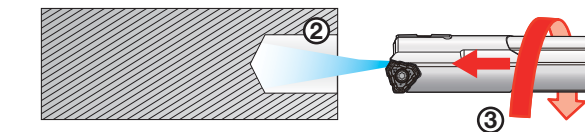

- ② Start coolant
- ③ Slowly insert DeepTriDrill into the guide hole
No. of revolution: $n = 50 - 100 \text{ rpm}$
Feed speed: $V_f = 4 - 12 \text{ ipm}$
Caution: Do not rotate the drill at machining speed outside the hole

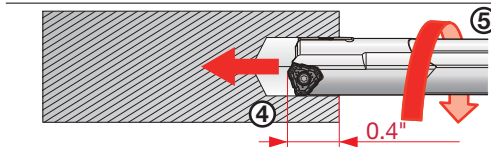

- ④ Stop the drill at $0.4''$ depth
- ⑤ Start rotating at machining speed

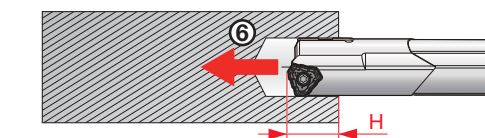

- ⑥ Start feed
At the entrance ($H = 0.4'' - 0.6''$)
→ Feed: $f = 80\%$ of programmed feed
Hole depth: $H \geq 0.6''$ → Feed: $f = 100\%$

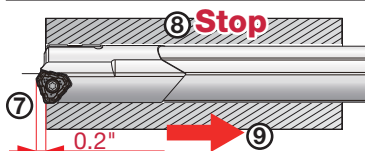

- ⑦ For through hole
Continue drilling until the drill head passes through the workpiece by $0.2''$
- ⑧ Stop the rotation and coolant
- ⑨ Return the drill (Head back to the starting position)

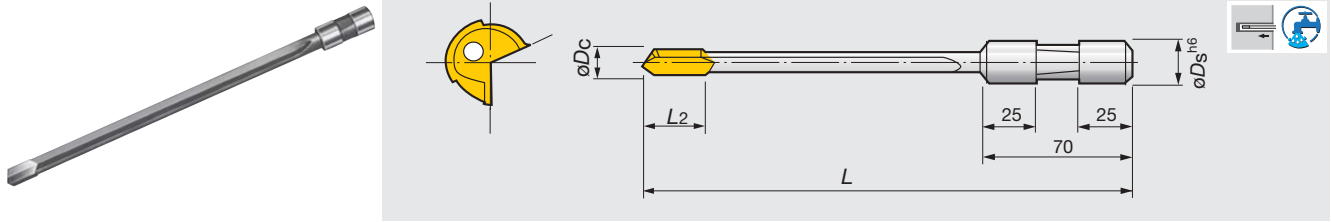

Deep Hole Drill

Metric	ϕD_c	ϕD_s	L_2	L
SLJ0300L0400NA	3	12.7	15	400
SLJ0300L0600NA	3	12.7	15	600
SLJ0500L0600NA	5	12.7	25	600
SLJ0550L0600NA	5.5	19.05	25	600
SLJ0600L0600NA	6	19.05	25	600
SLJ0700L0600NA	7	19.05	25	600
SLJ0800L0600NA	8	19.05	25	600
SLJ1000L0600NA	10	19.05	30	600
SLJ0500L1000NA	5	12.7	25	1000
SLJ0600L1000NA	6	19.05	25	1000
SLJ0700L1000NA	7	19.05	25	1000
SLJ0800L1000NA	8	19.05	25	1000
SLJ1000L1000NA	10	19.05	30	1000
SLJ0600L1250NA	6	19.05	25	1250
SLJ0610L1250NA	6.1	19.05	25	1250
SLJ0620L1250NA	6.2	19.05	25	1250
SLJ0700L1250NA	7	19.05	25	1250
SLJ0800L1250NA	8	19.05	25	1250
SLJ0810L1250NA	8.1	19.05	25	1250
SLJ0820L1250NA	8.2	19.05	25	1250
SLJ1000L1250NA	10	19.05	30	1250
SLJ1010L1250NA	10.1	19.05	30	1250
SLJ1020L1250NA	10.2	19.05	30	1250
SLJ1200L1250NA	12	19.05	30	1250
SLJ1210L1250NA	12.1	19.05	30	1250
SLJ1220L1250NA	12.2	19.05	30	1250
SLJ0600L1650NA	6	19.05	25	1650
SLJ0610L1650NA	6.1	19.05	25	1650
SLJ0620L1650NA	6.2	19.05	25	1650
SLJ0700L1650NA	7	19.05	25	1650
SLJ0800L1650NA	8	19.05	25	1650
SLJ0810L1650NA	8.1	19.05	25	1650
SLJ0820L1650NA	8.2	19.05	25	1650
SLJ1000L1650NA	10	19.05	30	1650
SLJ1010L1650NA	10.1	19.05	30	1650
SLJ1020L1650NA	10.2	19.05	30	1650
SLJ1200L1650NA	12	19.05	30	1650
SLJ1210L1650NA	12.1	19.05	30	1650
SLJ1220L1650NA	12.2	19.05	30	1650

TUBE DIAMETER

ϕD_c	ϕD_p	ϕD_c	ϕD_p	ϕD_c	ϕD_p
3 - 3.19	2.9	5.2 - 5.49	5	8.7 - 9.19	8.5
3.2 - 3.39	3.1	5.5 - 5.79	5.3	9.2 - 9.69	9
3.4 - 3.59	3.3	5.8 - 5.99	5.6	9.7 - 10.39	9.5
3.6 - 3.89	3.5	6 - 6.19	5.8	10.4 - 10.89	10
3.9 - 4.09	3.7	6.2 - 6.59	5.9	10.9 - 11.39	10.6
4.1 - 4.29	3.9	6.6 - 7.09	6.4	11.4 - 11.99	11.1
4.3 - 4.49	4.1	7.1 - 7.59	6.9	12 - 12.2	11.7
4.5 - 4.89	4.3	7.6 - 8.09	7.4		
4.9 - 5.19	4.7	8.1 - 8.69	7.9		

(Unit: mm)

STANDARD CUTTING CONDITIONS

ISO	Workpiece material	Heat treatment	Hardness		Cutting speed Vc (sfm)	Feed f (ipr)
			HB	HRC		
P	Free-cutting carbon steels		160 - 190	(5) - (11)	430	Refer to Fig. 1
	Carbon steels	Cold drawn	200 - 230	(12) - 20	330	
		Hardened and tempered	250 - 300	25 - 32	260	
		Annealed	110 ~ 120		430	
		Annealed	120 ~ 185	~ (9)	390	
		Annealed	170 ~ 200	(5) ~ (13)	330	
		Alloy steels	Hardened and tempered	210 ~ 250	(16) ~ 24	
	Hardened and tempered	260 ~ 310	26 ~ 33	230		
	Hardened and tempered	320 ~ 375	34 ~ 40	160		
	Hardened and tempered	380 ~ 440	41 ~ 47	130		
	Alloy steels	Annealed	150 ~ 230	~ (20)	300	Refer to Fig. 2
		Annealed or Hardened and tempered	240 ~ 310	23 ~ 33	230	Refer to Fig. 2
			315 ~ 370	34 ~ 40	160	Refer to Fig. 3
			380 ~ 440	40 ~ 47	130	
450 ~ 500			48 ~ 51	100		
Cast steels		Annealed	140 ~ 180	~ (8)	330	Refer to Fig. 2
	Annealed	190 ~ 240	(11) ~ 22	300		
Tool steels	Annealed	150 ~ 200	~ (13)	230	Refer to Fig. 3	
	Annealed	210 ~ 300	(16) ~ 32	160		
M	Stainless steels Ferritic	Annealed	150 ~ 200	~ (13)	230	Refer to Fig. 3
	Austenitic	Annealed	160 ~ 220	~ (18)	160	
	Martensitic	Hardened and tempered	160 ~ 220	~ (18)	230	
300 ~ 350			32 ~ 38	160		
K	Gray cast irons		110 ~ 180		300	Refer to Fig. 4
			190 ~ 220		260	
			220 ~ 260		230	
	Ductile cast irons		120 ~ 170		260	Refer to Fig. 5
			180 ~ 240		210	
			240 ~ 280		180	
			260 ~ 320		130	
			110 ~ 180		300	
	Malleable cast irons		190 ~ 220		260	
			220 ~ 260		230	
N	Cast aluminum alloys	Annealed	5000load		590	Refer to Fig. 4
	Aluminum die cast alloys		40 ~ 100			
H	Copper alloys	Annealed	120 ~ 160		< 490	Refer to Fig. 4
			160 ~ 205		< 490	Refer to Fig. 5
H	Bearing steels		150 ~ 210		230	Refer to Fig. 3
	High-resistant steels				70	
	High speed steels		210 ~ 285	(16) ~ 30	160	

Fig. 1 Carbon steels

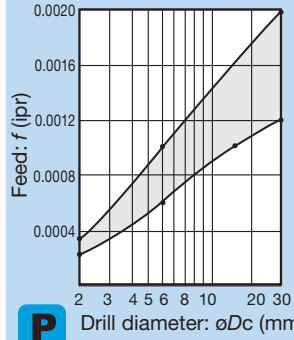

Fig. 2 Alloy steels

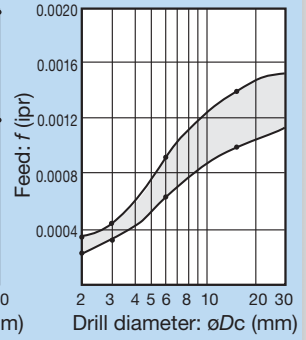

Fig. 3 Tool steels and other special steels

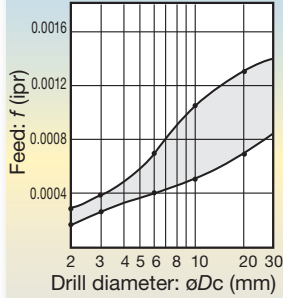

Fig. 4 Cast irons, aluminum alloys

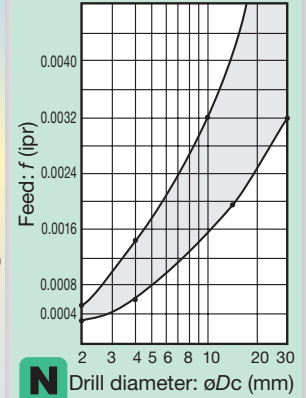
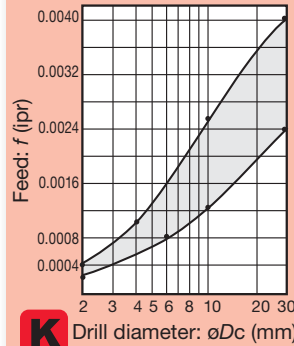
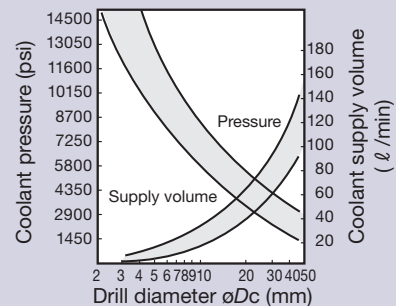

Fig. 5 Ductile and malleable cast irons



Coolant supply pressure and volume



Deep Hole Drill

Guidelines for attainable accuracies

Workpiece material	Surface roughness (µm)	Roundness (µm)	Cylindricity (µm)	Over size (µm)
Carbon and alloy steels	0.236 ~ 0.984	0.197 ~ 0.394	0.394 ~ 0.591	- 0.197 ~ 1.181
Cast irons	0.118 ~ 0.591	0.118 ~ 0.197	0.197 ~ 0.394	- 0.197 ~ 0.591
Aluminum alloys, Copper alloys	0.012 ~ 0.236	0.118 ~ 0.197	0.197 ~ 0.394	- 0.394 ~ 0.197

Note: Over size values given in the table are based on the drill diameter.

Cutting fluid

A water-insoluble fluid is recommended when machining with gun drills. When using water soluble fluid, use the fluid for heavy duty cutting in higher concentration.



Deep Hole Drill

BTA tool product map

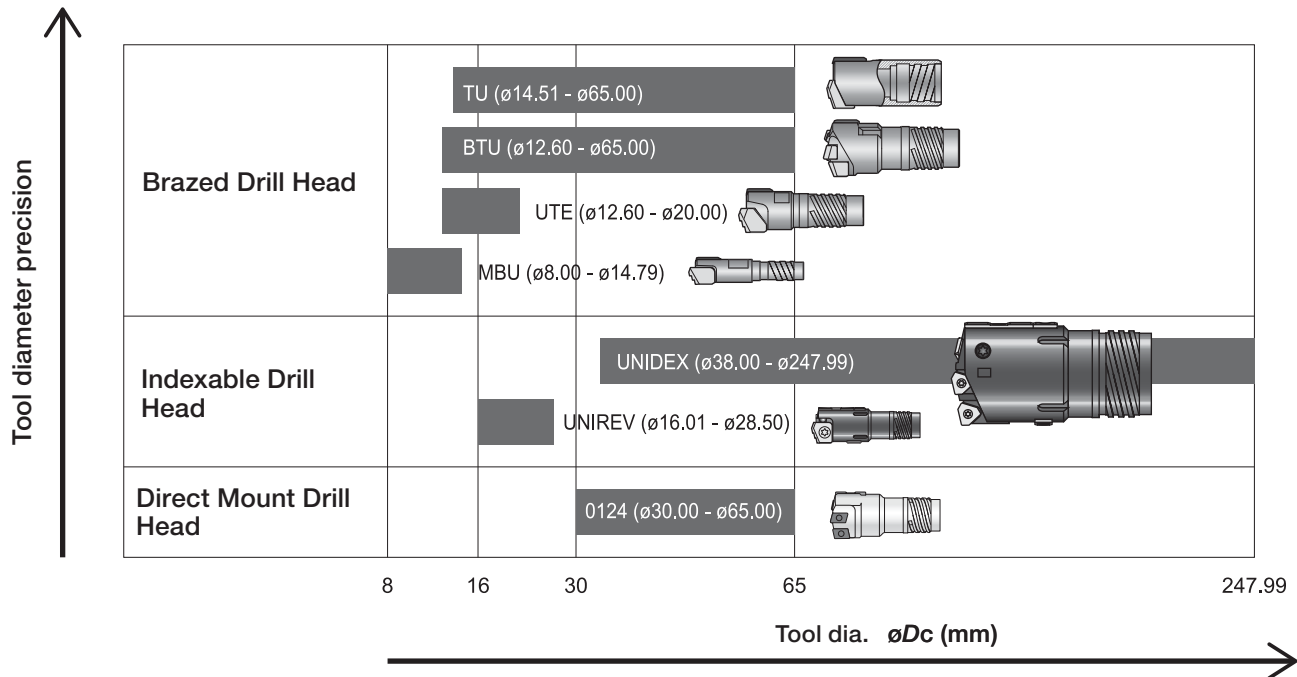

Deep Hole Drill

Single Tube System (STS) and Double Tube System (DTS)

Single Tube System (STS)

The STS may also be referred to as the BTA system in the deep hole drilling process. A large volume of coolant is pumped under high pressure to the cutting area in the workpiece. Chips are then forced out through the drill tube at the back and they do not touch workpiece allowing super surface finish. STS is a very good method to obtain holes of high productivity and high accuracy by using a dedicated drilling machine and a sealing with the workpiece.

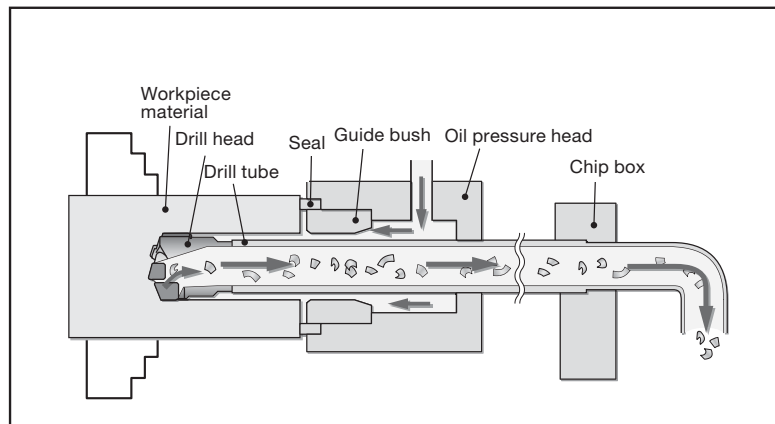

Double Tube System (DTS)

The DTS is characterized by its two tube construction and is therefore known as the double tube system. A sealing system and pressure head, which is required in the Single Tube System (STS) is not necessary for the DTS and it is therefore suitable for conventional general purpose machines such as lathes or machining centers.

In general, because of less efficient chip evacuation than the STS the recommended max drilling depth is 1000mm. However, the unique DTC-R tube connector that is capable of supplying high pressure coolant can successfully achieve drilling depths of up to 2000mm.

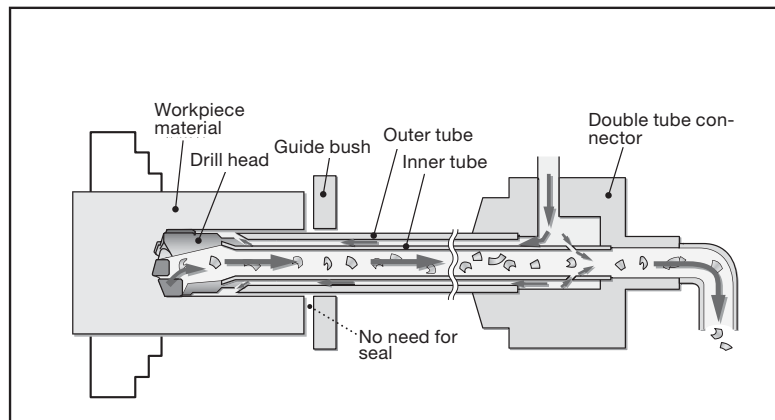

Deep hole drilling head series



Single Tube System

Solid Drilling Tools

Mounting screw type	Code	Appearance	Diameter range ϕD_c (mm)	Hole tolerance	Surface finish Ra (μm)	Drill head type	Feature
Outer Thread	MBU		8 - 14.79 (0.315" - 0.582")	IT9	2	Brazed Drill Head	- Higher productivity and better surface finish than gundrill. - Good chip breaking with 3 step cutting edge design.
	UTE		12.6 - 20 (0.496" - 0.787")	IT9	2		- Higher productivity and better surface finish than gundrill. - Good chip breaking with 3 step cutting edge design. - First recommendation for dia. $\phi 12.60$ - 15.59.
	BTU		12.6 - 65 (0.496" - 2.559")	IT9	2		- First recommendation for dia. $\phi 15.60$ or more. - Good chip breaking with 3 cutting edges. ($\phi 12.60$ - 15.59mm has 2 cutting edges) - Covers all materials with various carbide grade combinations.
	KUSTS		38 - 247.99 (1.496" - 9.763")	IT10	3	Indexable Drill Head	- Cartridge type - Diameter finely adjustable - Multiple options to cover various cutting condition.
	0124		30 - 65 (1.181" - 2.559")	IT11	3		- No diameter setting necessary. - For highly efficient and stable deep hole drilling
Inner Thread	KUSTS		38 - 245.99 (1.496" - 9.685")	IT10	3	Indexable Drill Head	- High productivity & High accuracy. - Covers a wide application area with various options
	0124		30 - 65 (1.181" - 2.559")	IT11	3		- No diameter setting necessary. - For highly efficient and stable deep hole drilling

Counterboring Tools

Mounting screw type	Code	Appearance	Diameter range ϕD_c (mm)	Hole tolerance	Surface finish Ra (μm)	Drill head type	Feature
Outer Thread	KUSTR		25 - 291.99 (0.984" - 11.496")	IT10	1 - 2	Indexable Drill Head	- High productivity & High accuracy. - Covers a wide application area with various options
Inner Thread	KUSTR		25 - 293.99 (0.984" - 11.574")	IT10	1 - 2		- High productivity & High accuracy. - Covers a wide application area with various options

Trepanning Tools

Mounting screw type	Code	Appearance	Diameter range ϕD_c (mm)	Hole tolerance	Surface finish Ra (μm)	Drill head type	Feature
Outer Thread	UTT		100 - (3.937" -)	IT10	1 - 2	Indexable Drill Head	- High productivity & High accuracy. - Covers a wide application area with various options
Inner Thread	UTT		100 - (3.937" -)	IT10	1 - 2		- High productivity & High accuracy. - Covers a wide application area with various options

Double Tube System

Solid Drilling

Mounting screw type	Code	Appearance	Diameter range ϕD_c (mm)	Hole tolerance	Surface finish Ra (μm)	Drill head type	Feature
Outer Thread	ETU		18.4 - 65 (0.724" - 2.559")	IT9	2	Brazed Drill Head	- Good chip breaking with 3-step cutting edges - Covers all materials with various carbide grade combinations
	KUDTS		18.4 - 183.99 (0.724" - 7.244")	IT10	3	Indexable Drill Head	- Cartridge type with adjustable diameter - Covers a wide application area with various options
	0124		30 - 65 (1.181" - 2.559")	IT11	3		- Direct-mounting type avoid diameter setting - For highly efficient and stable deep hole drilling

Counterboring

Mounting screw type	Code	Appearance	Diameter range ϕD_c (mm)	Hole tolerance	Surface finish Ra (μm)	Drill head type	Feature
Outer Thread	KUDTR		25 - 183.99 (0.984" - 7.244")	IT10	1 - 2	Indexable Drill Head	- Cartridge type with adjustable diameter - Covers a wide application area with various options

- The above values may change depending on the machining conditions, materials, etc.

* Special designed tools are available as Tailor-made.

Economical for middle range deep hole drilling

- Diameter range 30 - 69 mm (1.181" - 2.717") *
- Drilling depth 6xD - 14xD
- Shortened drilling time when using conventional machine
- * Other diameters are available upon request.

Effective machining on conventional machines

- Recommended for use on Horizontal M/C
- Can also be used on turning machine

Good chip evacuation

- Inserts enable best chip control
- Unique head design eliminates chip jamming
- Curved flute design ensures good chip evacuation

Easy to use, rigid drill body

- Direct mount inserts, no diameter adjustment necessary
- Heat treated tool steel body

High quality surface finish

- Burnishing effect improves surface finish
- Possible to eliminate finish process

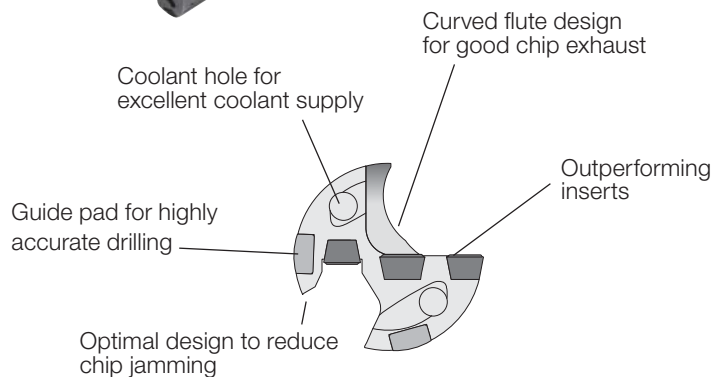

Actual result

Cutting conditions

Tool diameter ϕD_c : $\phi 1.181"$
 Drilling depth : 7.874"
 Workpiece material : 1045
 Cutting speed V_c : 330 sfm
 Spindle speed f : 0.004 ipr
 Machine : #50 M/C

No spiral marks caused by chips
 Guide pads burnishing effect improves surface finish



BT50 M/C Machining data

Excellent chip control ensures stable M/C machining

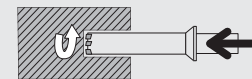
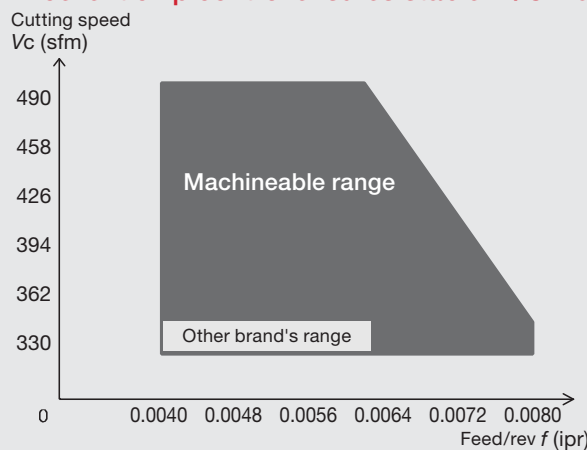

Coolant
 Type: Emulsion
 Pressure: 1.5MPa
 Supply: Through spindle
 (for #50)

Tool dia ϕD_c : $\phi 1.181"$
 Drilling depth : 7.874"
 Material : 1045
 Cutting speed
 V_c : 330 ~ 490 sfm
 Feed/rev f : 0.004 ~ 0.008 ipr
 Machine : #50 Horizontal
 M/C (Max 11 KW)

Note:

To start the tool, a pilot hole is required.
 (tolerance: + 0.004" to 0.006")

Tool dia. ϕD_c (mm)	Pilot hole length L_p (mm)
$\phi 30 \sim \phi 39$ ($\phi 1.181" \sim \phi 1.535"$)	over 10 (over 0.394")
$\phi 39.01 \sim \phi 45$ ($\phi 1.536" \sim \phi 1.771"$)	over 12.5 (over 0.492")
$\phi 45.01 \sim \phi 57$ ($\phi 1.772" \sim \phi 2.244"$)	over 15 (over 0.591")
$\phi 57.01 \sim \phi 69$ ($\phi 2.245" \sim \phi 2.717"$)	over 17.5 (over 0.689")

- The pilot hole should ideally have a flat bottom, but generally a throw-away drill is acceptable to create a pilot hole if the inner insert touches the bottom last.
- TDX drills are recommended for pre-hole drilling.



ToolLine









Tooling System

F002

ToolLine - Tooling System

			Inch	Metric
	TUNGCAP Quick change system with polygon PSC coupling tooling	<u>F004</u>	<input checked="" type="checkbox"/>	<input type="checkbox"/>
	SPINJET Coolant-driven high-speed spindles for small diameter tools	<u>F038</u>	<input checked="" type="checkbox"/>	<input checked="" type="checkbox"/>
	TUNGHOLD Tooling system for holders with unique functions in wide varieties HSK A/E F044 - CAT F069 - BT MAS F079 -	<u>F044</u>	<input checked="" type="checkbox"/>	<input checked="" type="checkbox"/>
	BEAMWRENCH Easy operation with correct clamping torque	<u>F126</u>	<input checked="" type="checkbox"/>	<input type="checkbox"/>

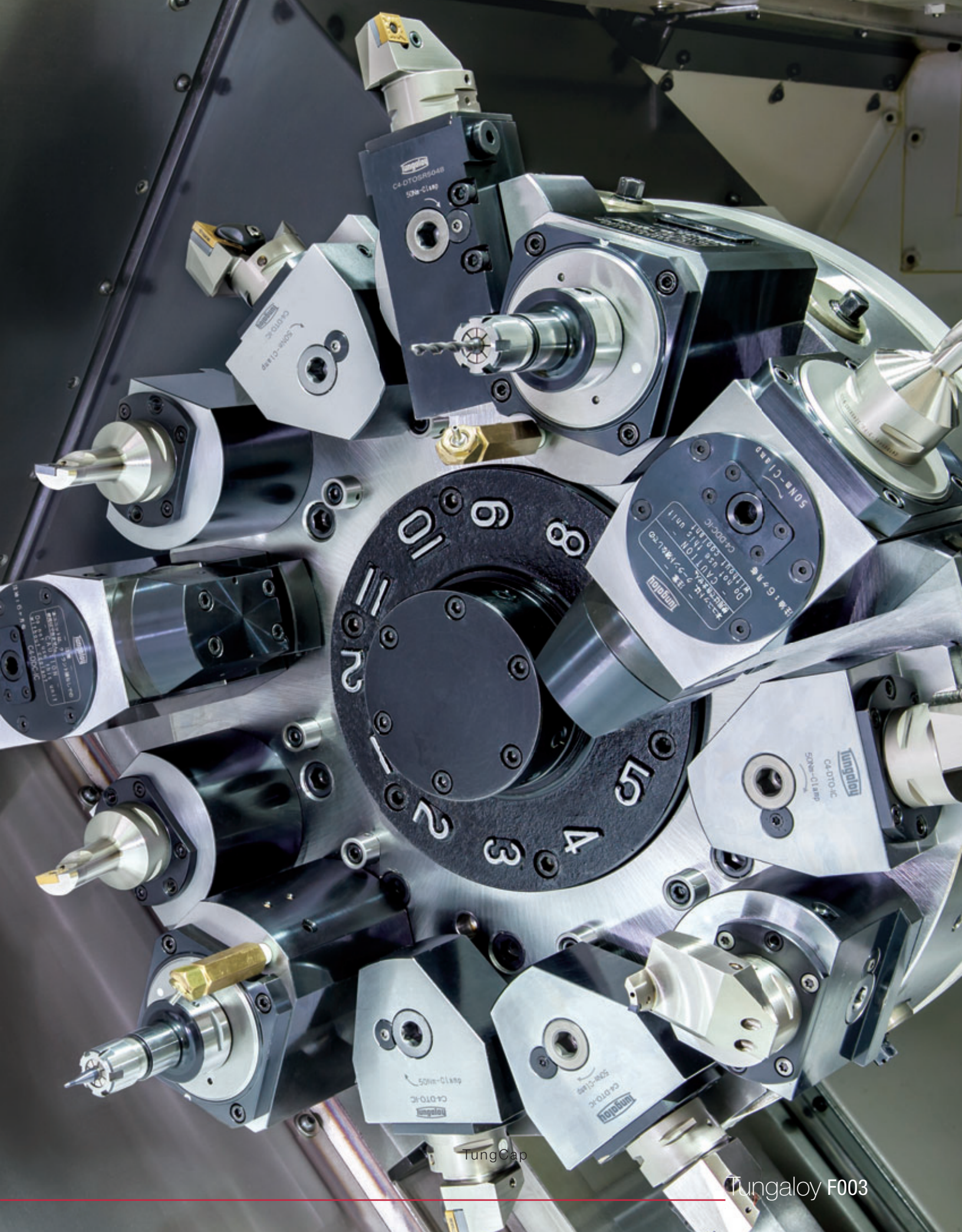



TungCap

Tungaloy F003



Turning tool

 B052 - CN**1204 CN**0904	 F007 TUNG TJET C*PCLNR/L*****CHP	 F006 C*PCLNR/L****-12N	 F006 C*ACLNR/L*****N	 B225 TUNG TJET C6PCMNN**CHP	 F007 TUNG TJET C*ACLNN00****N C*ACLNN00****V**N	Cutting head for external turning & facing
 B063 - DN**1504** (DN**1506**)	 F008 TUNG TJET C*PDJNR/L*****CHP	 F010 C*PDJNR/L****-15N	 F008 C*ADJNR/L*****N	 B226 TUNG TJET C6PDMNL**CHP	 F010 C*ADNN00****-15N	
 B097 - WN**0804 WN**0604	 F012 TUNG TJET C*PWLNR/L*****CHP	 F009 C*AWLNR/L*****N	 B093 - VN**1604**	 B224 TUNG TJET C*PVJNR/L*****-16-CHP	 F011 C*SVJCR/L*****-16N C*SVVCN00****-16N	
 B149 - VC**1604**	 F011 C*SVJCR/L*****-16N	 F011 C*SVVCN00****-16N				
 B063 - DN**1104	 F013 C4PDUNR/L-11	 B063 - DN**1504	 F013 C*ADUNR*****-15	 B052 - CN**1204 CN**0904	 F013 C4PCLNR/L*****	
 E006 - DRILLMEISTER	 F021 Side-lock holder (For weldon-shank) C*EM**X**	 F022 Side-lock holder (For whistle-notch shank) C*EM**X**E	 B190 - Boring bar	 F019 Sleeve SC*****	 F020 Adaptor for boring bar C*ABB** C*ADI**	Cutting head for internal turning
 E076 - TUNGDRILL	 E068 - TUNGSEX-DRILL				 E080 TungDrill Twisted C*TDX***L**-3	
	 B418 - 16ER/L**	 F012 C*CER/L*****-16ERN				Cutting head for threading
 C083 - DGS, SGS, DGM, SGM, DTX, DTE, DGG, DTR, SGN	 C067 Blade	 F064 Adaptor for parting-off blade	 F014 TUNG CUT C*CHSR/L*****N	 F014 TUNG CUT C*CHFVR/L*****N		Cutting head for grooving
 B190 - Toolholder for external turning	 F018 C*ADES-20	 F018 C*ASHR/L**-45	 F017 C*ASHR/L**	 F017 C*ASHA20	 F017 C*ADE**R/L	Adaptor for toolholder with square shank

The page number for the product details is shown in red.
Inserts are noted in metric designation.

System for Multi-Tasking Machine

TOOLING SYSTEM



Tooling System

TUNGALOY

Tool spindle



Tool spindle

<p>Endmill holder C*MAXIN**X** F028</p>	<p>Straight collet for endmill holder SC***** F028</p>	
---	--	--

<p>Side-lock holder (For weldon-shank) C*EM**X** F021</p>	
---	--

<p>Arbor for face mill C*SEM**X**C F026</p>	
---	--

<p>Arbor for slot mill C*FM**X** F027</p>	
---	--

<p>Extension adaptor C*EX-** F032 -</p>

<p>Side-lock holder (For whistle-notch shank) C*EM**X**E F022</p>	
---	--

<p>Holder for modular tool TUNGFLEX C*ODP**X** F027</p>	
--	--

<p>ER-collet chuck holder C*ER**X** C*ER**X**M F023 F024</p>	<p>ER-collet ER***** F099 -</p>	
--	---	--

<p>High speed spindle SPINJET TJS**KC*/L/R F039</p>	
--	--

<p>Reduction adaptor C*-C*RE-*** Adaptor for C4 or C5 coupling F033 -</p>

<p>Collet chuck holder with adjusting alignment TUNGFINE ADJC*ER32 F024</p>	<p>ER-collet ER***** F099 -</p>	
--	---	--

<p>TungDrillTwisted drill C*TDX**L***-3 E080</p>
--

<p>Shrink holder TUNGSHRINK C*SRKIN**X** F030</p>	
--	--

Tool clamp



MULTICLAMP*
F077

The page number for the product details is shown in red.



TUNGCAP

C-ACLNR/L

Turning A double-clamping toolholder with 95° approach angle, for negative 80° rhombic inserts

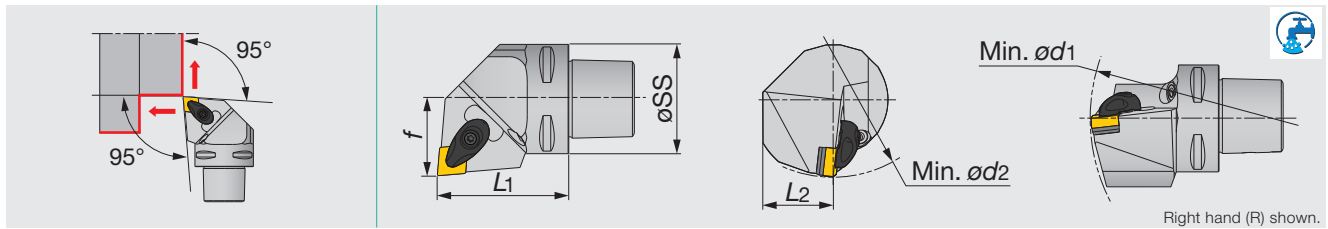

Metric	øSS	L1	L2	f	Min ød1	Min ød2	rε	Insert
C4ACLNR/L27050-12N	40	50	25	27	140	110	0.8	CN**1204...
C5ACLNR/L35060-12N	50	60	32	35	165	110	0.8	CN**1204...
C6ACLNR/L45065-12N	63	65	41	45	190	125	0.8	CN**1204...
C6ACLNR/L45065-16N	63	65	41	45	190	125	1.2	CN**1604...

• Applicable for 7 MPa pressure coolant

SPARE PARTS									
Designation	Clamp	Clamping screw	Coolant parts	Shim	Shim screw	Spring	Spring 1	Wrench	Wrench 1
C4ACLN*27050-12N	ACP4S	ACS-5W	SATZ-M8X1-M3	ASC422	CSTB-3.5	BP-7	SP-2.5	-	T-15F
C5ACLN*35060-12N	ACP4S	ACS-5W	SATZ-M8X1-M3	ASC422	CSTB-3.5	BP-7	SP-2.5	-	T-15F
C6ACLN*45065-12N	ACP4S	ACS-5W	SATZ-M8X1-M3	ASC422	CSTB-3.5	BP-7	SP-2.5	-	T-15F
C6ACLN*45065-16N	ACP5S	ACS-6W	SATZ-M8X1-M3	ASC533	CSTB-5	BP-8.8	SP-2.5	KEYV-T20	-

C-PCLNR/L

Lever lock type toolholder with 95° approach angle, for negative 80° rhombic inserts

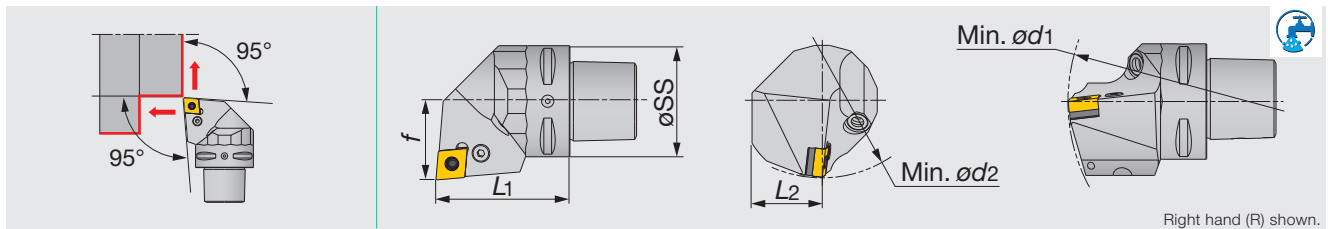

Metric	øSS	L1	L2	f	Min ød1	Min ød2	rε	Insert
C5PCLNR/L35060-12 ⁽¹⁾	50	60	32	35	-	-	0.8	CN**1204...
C5PCLNR/L35060-12N ⁽²⁾	50	60	32	35	165	110	0.8	CN**1204...
C6PCLNR/L45065-12N ⁽²⁾	63	65	41	45	190	125	0.8	CN**1204...

(1) Applicable for 3 MPa pressure coolant. (2) Applicable for 7 MPa pressure coolant.

SPARE PARTS						
Designation	Coolant parts	Lever	Clamping screw	Shim	Spring	Wrench
C5PCLN*35060-12	EZ104	LCL4	LCS4	LSC42	LSP4	P-3
C*PCLN**506*-12N	SATZ-M10X1-M5	LCL4	LCS4	LSC42	LSP4	P-3

Reference pages

C-ACLNR/L, C-PCLNR/L: Inserts → B052 -, CBN → B165 -, PCD → B178

Lever lock type toolholder with 95° approach angle, for negative 80° rhombic inserts, with channels for high pressure coolant

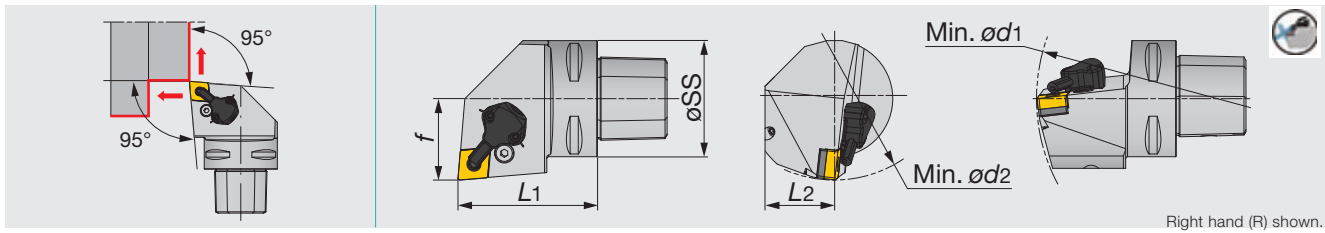

Metric	øSS	L1	L2	f	Min ød1	Min ød2	rε	Insert
C4PCLNR/L27050-0904-CHP	40	50	25	27	140	110	0.8	CN**0904...
C4PCLNR/L27050-12-CHP	40	50	25	27	140	110	0.8	CN**1204...
C5PCLNR/L35060-12-CHP	50	60	32	35	165	110	0.8	CN**1204...
C6PCLNR/L45065-0904-CHP	63	65	41	45	190	125	0.8	CN**0904...
C6PCLNR/L45065-12-CHP	63	65	41	45	190	125	0.8	CN**1204...

• Applicable for 14 MPa pressure coolant

SPARE PARTS FOR P-TYPE



Designation	Shim	Clamping screw	Spring pin	Lever	Wrench 1
C*PCLNR/L**-12-CHP	LSC42	LCS4	LSP4	LCL4	P-3
C*PCLNR/L**0904-CHP	LSC317	LCS3	LSP3	LCL33	P-2.5

COOLANT SET



Designation	Coolant unit	Mounting screw	Wrench 2	O-ring
C*PCLNR/L**-CHP	CU-CW-CHP	SRM3	T-8F	OR6.4X0.9N

C-ACLNN

Turning A double-clamping toolholder with 95° approach angle, for negative 80° rhombic inserts

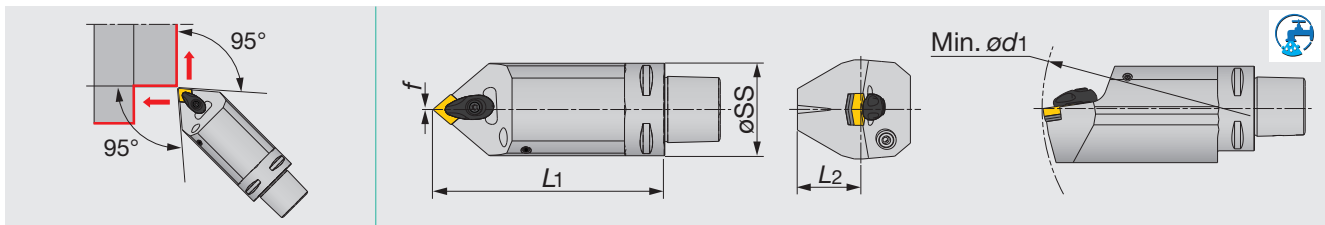

Metric	øSS	L1	L2	f	Min ød1	rε	Insert
C5ACLNN00090-12 ⁽¹⁾	50	90	32	0	-	0.8	CN**1204...
C5ACLNN00090-12N ⁽²⁾	50	90	32	0	165	0.8	CN**1204...
C5ACLNN00125-12 ⁽¹⁾	50	125	32	0	-	0.8	CN**1204...
C5ACLNN00125-12N ⁽²⁾	50	125	32	0	165	0.8	CN**1204...
C6ACLNN00100-12N ⁽²⁾	63	100	37.5	0	190	0.8	CN**1204...
C6ACLNN00140-12N ⁽²⁾	63	140	37.5	0	190	0.8	CN**1204...

• "-" in Min ød1: not suitable for internal boring

(1) Applicable for 3 MPa pressure coolant. (2) Applicable for 7 MPa pressure coolant.

SPARE PARTS



Designation	Clamp	Clamping screw	Coolant parts	Shim	Shim screw	Spring	Spring 1	Wrench
C5ACLNN00090-12	ACP4S	ACS-5W	EZ83	ASC422	CSTB-3.5	BP-7	SP-2.5	T-15F
C5ACLNN00090-12N	ACP4S	ACS-5W	SATZ-M8X1-M3	ASC422	CSTB-3.5	BP-7	SP-2.5	T-15F
C5ACLNN00125-12	ACP4S	ACS-5W	EZ83	ASC422	CSTB-3.5	BP-7	SP-2.5	T-15F
C*ACLNN001**-12N	ACP4S	ACS-5W	SATZ-M8X1-M3	ASC422	CSTB-3.5	BP-7	SP-2.5	T-15F

Reference pages

C-PCLNR/L-CHP, C-ACLNN: Inserts → B052 -, CBN → B165 -, PCD → B178



TUNG CAP

C-PDJNR/L-CHP

Lever lock type toolholder with TungCap connection, for negative 55° rhombic inserts, with channels for high pressure coolant

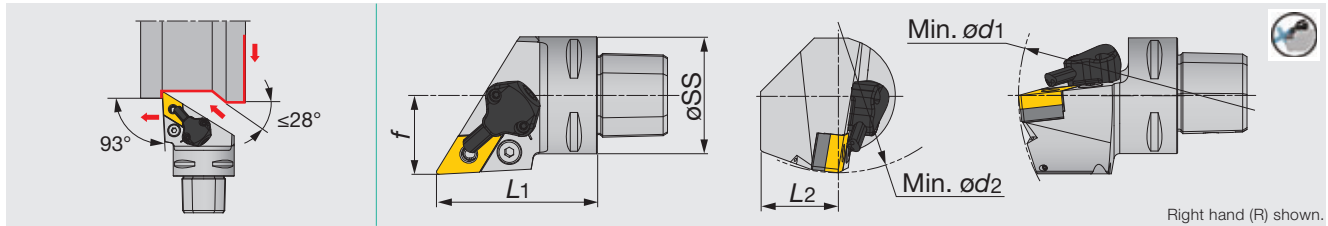

Metric	øSS	L1	L2	f	Min ød1	Min ød2	r _s	Insert
C4PDJNR/L27050-1104-CHP	40	50	25	27	140	110	0.8	DN**1104...
C4PDJNR/L27050-15-CHP	40	50	25	27	140	110	0.8	DN**1504(06)...
C5PDJNR/L35060-15-CHP	50	60	32	35	165	110	0.8	DN**1504(06)...
C6PDJNR/L45065-1104-CHP	63	65	41	45	190	110	0.8	DN**1104...
C6PDJNR/L45065-15-CHP	63	65	41	45	190	110	0.8	DN**1504(06)...

• Applicable for 14 MPa pressure coolant

SPARE PARTS FOR P-TYPE



Designation	Shim	Clamping screw	Spring pin	Lever	Wrench 1
C*PDJNR/L*-15-CHP	LSD43A	LCS4	LSP4	LCL4	P-3
C*PDJNR/L**1104-CHP	ELSD32	LCS3	LSP3	LCL33L	P-2.5

Option: LSD42A (Shim for DN**1506...), LSP4S (Spring pin for DN**1506...)

COOLANT SET



Designation	Coolant unit	Mounting screw	Wrench 2	O-ring
C*PDJNR/L*-CHP	CU-D-CHP	SRM3	T-8F	OR6.4X0.9N

C-ADJNR/L

Turning A double-clamping toolholder with 93° approach angle, for negative 55° rhombic inserts

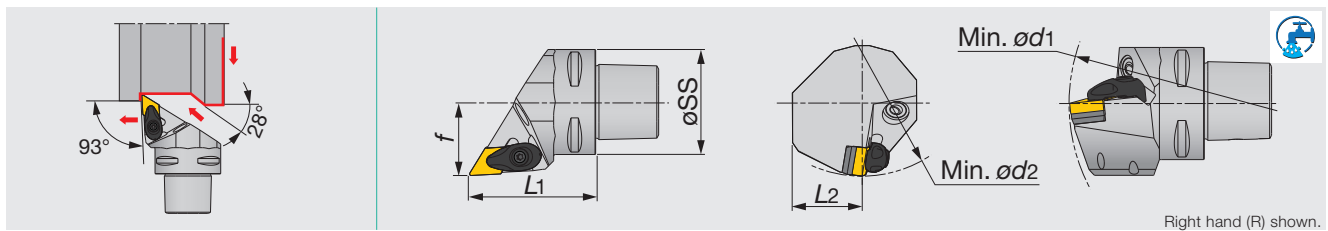

Metric	øSS	L1	L2	f	Min ød1	Min ød2	r _s	Insert
C4ADJNR/L27050-15N ⁽²⁾	40	50	25	27	145	110	0.8	DN**15...
C5ADJNR/L35060-15N ⁽²⁾	50	60	32	35	165	110	0.8	DN**15...
C6ADJNR/L45065-15 ⁽¹⁾	63	65	41	45	-	-	0.8	DN**15...
C6ADJNR/L45065-15N ⁽²⁾	63	65	41	45	190	110	0.8	DN**15...
C6ADJNR/L45135-15N ⁽²⁾	63	135	41	45	190	110	0.8	DN**15...

• "-" in Min ød1 and ød2: not suitable for internal boring

(1) Applicable for 3 MPa pressure coolant (2) Applicable for 7 MPa pressure coolant

SPARE PARTS



Designation	Clamp	Clamping screw	Coolant parts	Shim	Shim screw	Spring	Spring 1	Wrench
C4ADJN*27050-15N	ACP4S	ACS-5W	SATZ-M10X1-M5	ASD432	CSTB-3.5	BP-7	SP-2.5	T-15F
C5ADJN*35060-15N	ACP4S	ACS-5W	SATZ-M10X1-M5	ASD432	CSTB-3.5	BP-7	SP-2.5	T-15F
C6ADJNL45065-15	ACP4S	ACS-5W	EZ104	ASD432	CSTB-3.5	BP-7	SP-2.5	T-15F
C6ADJN*45065-15N	ACP4S	ACS-5W	SATZ-M10X1-M5	ASD432	CSTB-3.5	BP-7	SP-2.5	T-15F
C6ADJN*45135-15N	ACP4S	ACS-5W	SATZ-M10X1-M5	ASD432	CSTB-3.5	BP-7	SP-2.5	T-15F

Option: ASD423 (Shim for DN**1506**)

Reference pages

C-ADJNR/L, C-PDJNR/L-CHP: Inserts → **B063 -**, CBN → **B165 -**, PCD → **B178**

Turning A double-clamping toolholder with 95° approach angle, for negative trigon inserts

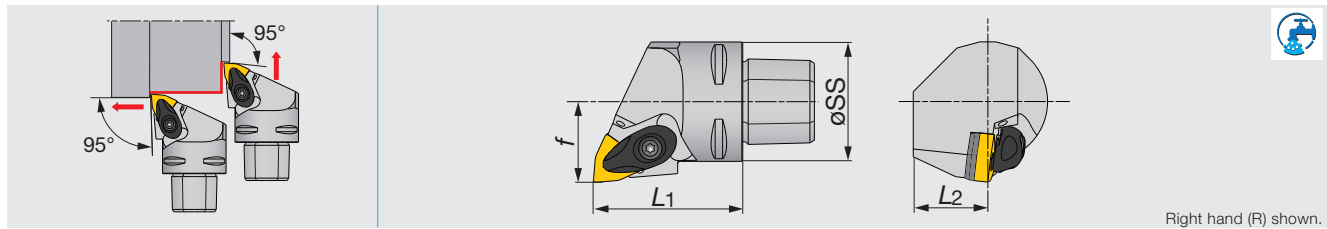

Right hand (R) shown.

Metric	øSS	L1	L2	f	rε	Insert
C4AWLNR/L27050-08N	40	50	25	27	0.8	WN**0804...

- Applicable for 7 MPa pressure coolant.

SPARE PARTS

Designation	Clamp	Clamp screw	Shim	Shim screw	Spring	Spring pin	Wrench
C4AWLNR/L27050-08N	ACP4S	ACS-5W	ASW422	CSTB-3.5	BP-7	SP-2.5	T-15F

Reference pages

C-AWLNR/L: Inserts → **B097 -**, CBN → **B167**





TUNG CAP

C-PDJNR/L

Lever lock type toolholder with 93° approach angle, for negative 55° rhombic inserts

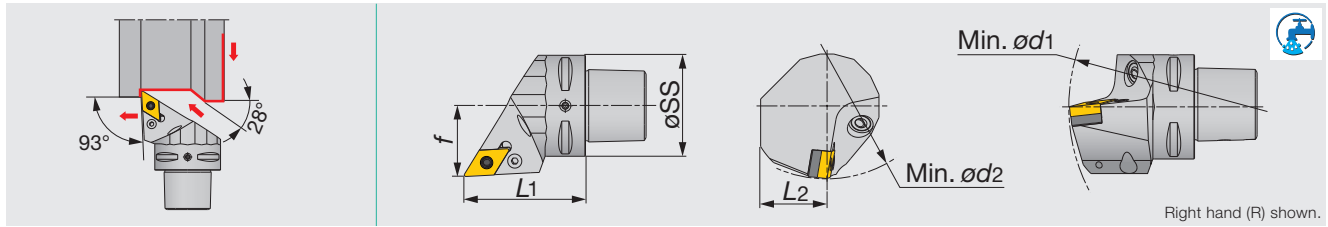

Right hand (R) shown.

Metric	øSS	L1	L2	f	Min ød1	Min ød2	rε	Insert
C5PDJNR/L35060-15N	50	60	32	35	165	110	0.8	DN**1504(06)
C6PDJNR/L45065-15N	63	65	41	45	195	95	0.8	DN**1504(06)

• Applicable for 7 MPa pressure coolant.

SPARE PARTS

Designation	Coolant parts	Shim	Lever	Clamping screw	Spring	Wrench
C5PDJNR/L35060-15N	SATZ-M10X1-M5	LSD43A	LCL4	LCS4	LSP4	P-3
C6PDJNR/L45065-15N	SATZ-M10X1-M5	LSD43A	LCL4	LCS4	LSP4S	P-3

Option: LSD42A (Shim for DN**1506...), LSP4S (Spring pin for DN**1506...)

C-ADNNN

Turning A double-clamping toolholder with 63° approach angle, for negative 55° rhombic inserts

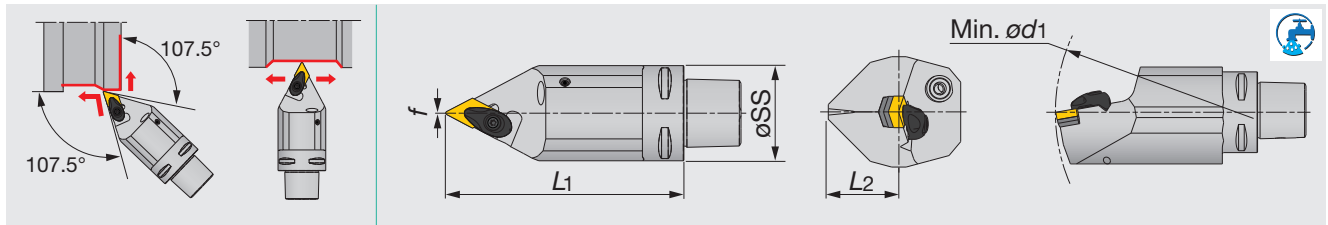

Metric	øSS	L1	L2	f	Min ød1	rε	Insert
C5ADNNN00090-15 ⁽¹⁾	50	90	32	0	-	0.8	DN**1504(06)
C5ADNNN00090-15N ⁽²⁾	50	90	32	0	165	0.8	DN**1504(06)
C5ADNNN00125-15 ⁽¹⁾	50	125	32	0	-	0.8	DN**1504(06)
C5ADNNN00125-15N ⁽²⁾	50	125	32	0	165	0.8	DN**1504(06)
C6ADNNN00100-15 ⁽¹⁾	63	100	37.5	0	-	0.8	DN**1504(06)
C6ADNNN00100-15N ⁽²⁾	63	100	37.5	0	190	0.8	DN**1504(06)
C6ADNNN00140-15 ⁽¹⁾	63	140	37.5	0	-	0.8	DN**1504(06)
C6ADNNN00140-15N ⁽²⁾	63	140	37.5	0	190	0.8	DN**1504(06)

• "-" in Min ød1: not suitable for internal boring

(1) Applicable for 3 MPa pressure coolant. (2) Applicable for 7 MPa pressure coolant.

SPARE PARTS

Designation	Clamp	Clamping screw	Coolant parts	Shim	Shim screw	Spring	Spring 1	Wrench
C5ADNNN00090-15	ACP4S	ACS-5W	EZ104	ASD432	CSTB-3.5	BP-7	SP-2.5	T-15F
C5ADNNN00090-15N	ACP4S	ACS-5W	SATZ-M10X1-M5	ASD432	CSTB-3.5	BP-7	SP-2.5	T-15F
C5ADNNN00125-15	ACP4S	ACS-5W	EZ104	ASD432	CSTB-3.5	BP-7	SP-2.5	T-15F
C5ADNNN00125-15N	ACP4S	ACS-5W	SATZ-M10X1-M5	ASD432	CSTB-3.5	BP-7	SP-2.5	T-15F
C6ADNNN00100-15	ACP4S	ACS-5W	EZ104	ASD432	CSTB-3.5	BP-7	SP-2.5	T-15F
C6ADNNN00100-15N	ACP4S	ACS-5W	SATZ-M10X1-M5	ASD432	CSTB-3.5	BP-7	SP-2.5	T-15F
C6ADNNN00140-15	ACP4S	ACS-5W	EZ104	ASD432	CSTB-3.5	BP-7	SP-2.5	T-15F
C6ADNNN00140-15N	ACP4S	ACS-5W	SATZ-M10X1-M5	ASD432	CSTB-3.5	BP-7	SP-2.5	T-15F

option: ASD423 (Shim for DN**1506**)

Reference pages

C-PDJNR/L, C-ADNNN: Inserts → **B063 -**, CBN → **B165 -**, PCD → **B178**

Screw-on clamp toolholder with 93° approach angle, for positive 35° rhombic inserts

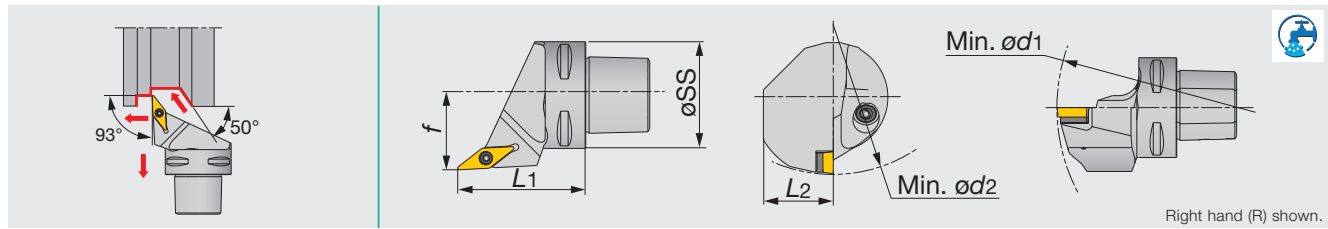

Metric	øSS	L1	L2	f	Min ød1	Min ød2	rε	Insert
C5SVJCR/L35060-16 ⁽¹⁾	50	60	32	35	-	-	0.8	VC**1604...
C5SVJCR/L35060-16N ⁽²⁾	50	60	32	35	170	160	0.8	VC**1604...
C6SVJCR/L45065-16 ⁽¹⁾	63	65	41	45	-	-	0.8	VC**1604...
C6SVJCR/L45065-16N ⁽²⁾	63	65	41	45	170	190	0.8	VC**1604...

• "-" in Min ød1: not suitable for internal boring
 (1) Applicable for 3 MPa pressure coolant. (2) Applicable for 7 MPa pressure coolant.

SPARE PARTS

Designation	Clamping screw	Coolant parts	Shim	Shim screw	Wrench	Wrench 1
C5SVJC*35060-16	CSTB-3.5L	EZ104	SSV32	DTS5-3.5	P-3.5	T-15F
C5SVJC*35060-16N	CSTB-3.5L	SATZ-M10X1-M5	SSV32	DTS5-3.5	P-3.5	T-15F
C6SVJC*45065-16	CSTB-3.5L	EZ104	SSV32	DTS5-3.5	P-3.5	T-15F
C6SVJC*45065-16N	CSTB-3.5L	SATZ-M10X1-M5	SSV32	DTS5-3.5	P-3.5	T-15F

C-SVVCN

Screw-on clamp toolholder with 72.5° approach angle, for positive 35° rhombic inserts

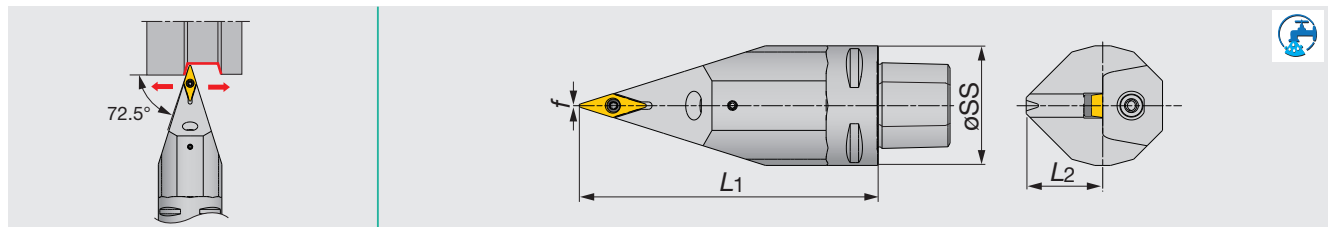

Metric	øSS	L1	L2	f	rε	Insert
C5SVVCN00090-16 ⁽¹⁾	50	90	32	0	0.8	VC**1604...
C5SVVCN00090-16N ⁽²⁾	50	90	32	0	0.8	VC**1604...
C5SVVCN00125-16 ⁽¹⁾	50	125	32	0	0.8	VC**1604...
C5SVVCN00125-16N ⁽²⁾	50	125	32	0	0.8	VC**1604...
C6SVVCN00100-16 ⁽¹⁾	63	100	37.5	0	0.8	VC**1604...
C6SVVCN00100-16N ⁽²⁾	63	100	37.5	0	0.8	VC**1604...
C6SVVCN00140-16 ⁽¹⁾	63	140	37.5	0	0.8	VC**1604...
C6SVVCN00140-16N ⁽²⁾	63	140	37.5	0	0.8	VC**1604...

(1) Applicable for 3 MPa pressure coolant. (2) Applicable for 7 MPa pressure coolant.

SPARE PARTS

Designation	Clamping screw	Coolant parts	Shim	Shim screw	Wrench	Wrench 1
C5SVVCN00090-16	CSTB-3.5L	EZ104	SSV32	DTS5-3.5	P-3.5	T-15F
C5SVVCN00090-16N	CSTB-3.5L	SATZ-M10X1-M5	SSV32	DTS5-3.5	P-3.5	T-15F
C5SVVCN00125-16	CSTB-3.5L	EZ104	SSV32	DTS5-3.5	P-3.5	T-15F
C5SVVCN00125-16N	CSTB-3.5L	SATZ-M10X1-M5	SSV32	DTS5-3.5	P-3.5	T-15F
C6SVVCN00100-16	CSTB-3.5L	EZ104	SSV32	DTS5-3.5	P-3.5	T-15F
C6SVVCN00100-16N	CSTB-3.5L	SATZ-M10X1-M5	SSV32	DTS5-3.5	P-3.5	T-15F
C6SVVCN00140-16	CSTB-3.5L	EZ104	SSV32	DTS5-3.5	P-3.5	T-15F
C6SVVCN00140-16N	CSTB-3.5L	SATZ-M10X1-M5	SSV32	DTS5-3.5	P-3.5	T-15F

Reference pages

C-SVJCR/L, C-SVVCN: Inserts → **B149** -, CBN → **B171** -, PCD → **B179** -



TUNGCAP

C-PWLN/L-CHP

Lever lock type toolholder with TungCap connection, for negative inserts W 80° trigon, with channels for high pressure coolant

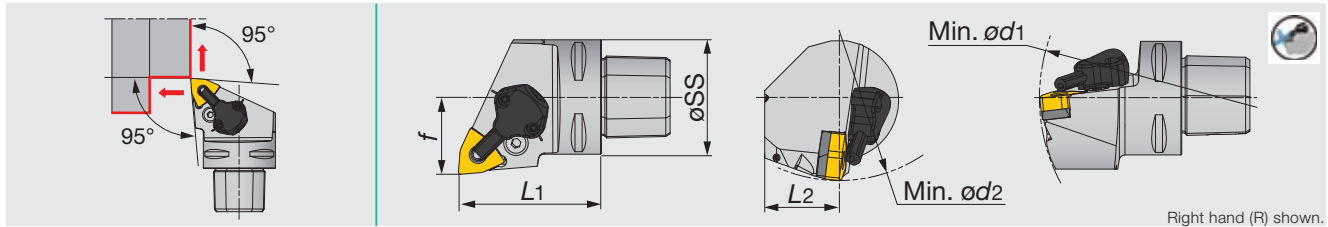

Right hand (R) shown.

Metric	øSS	L1	L2	f	Min ød1	Min ød2	rε	Insert
C4PWLN/L27050-0604-CHP	40	50	25	27	140	110	0.8	WN**0604...
C4PWLN/L27050-08-CHP	40	50	25	27	140	110	0.8	WN**0804...
C6PWLN/L45065-08-CHP	63	65	41	45	190	110	0.8	WN**0804...

• Applicable for 14 MPa pressure coolant

SPARE PARTS FOR P-TYPE



COOLANT SET



Designation	Shim	Clamping screw	Spring pin	Lever	Wrench 1	Designation	Coolant unit	Mounting screw	Wrench 2	O-ring
C*PWLN/L*-08-CHP	LSW42BL	LCS4	LSP4	LCL4	P-3	C*PWLN/L*-CHP	CU-CW-CHP	SRM3	T-8F	OR6.4X0.9N
C*PWLN/L**0604-CHP	LSW312	LCS3	LSP3	LCL3	P-2.5					

C-CER/L

TungThread external threading toolholders, alternative clamping of screw-on or clamp-on

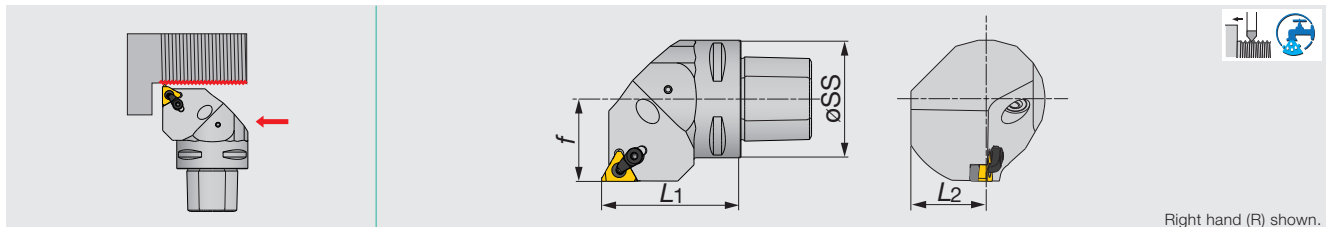

Right hand (R) shown.

Metric	øSS	L1	L2	f	rε	Insert
C4CER/L27050-16ERN ⁽²⁾	40	50	25	27	0.8	16ER/L...
C5CER/L35060-16ER ⁽¹⁾	50	60	32	35	0.8	16ER/L...
C5CER/L35060-16ERN ⁽²⁾	50	60	32	35	0.8	16ER/L...
C6CER/L45065-16ER ⁽¹⁾	63	65	41	45	0.8	16ER/L...
C6CER/L45065-16ERN ⁽²⁾	63	65	41	45	0.8	16ER/L...

(1) Applicable for 3 MPa pressure coolant. (2) Applicable for 7 MPa pressure coolant.

SPARE PARTS



Designation	Clamp set	Clamping screw	Coolant parts	Shim screw	Shim	Wrench	Wrench 1
C5CE*35060-16ER	CSP16	CSTB-3.5ST	EZ104	DTS5-3.5	A16-1DT	P-3.5	T-15F
C5CE*35060-16ERN	CSP16	CSTB-3.5ST	SATZ-M10X1-M5	DTS5-3.5	A16-1DT	P-3.5	T-15F
C6CE*45065-16ER	CSP16	CSTB-3.5ST	EZ104	DTS5-3.5	A16-1DT	P-3.5	T-15F
C6CE*45065-16ERN	CSP16	CSTB-3.5ST	SATZ-M10X1-M5	DTS5-3.5	A16-1DT	P-3.5	T-15F

Reference pages

C-PWLN/L-CHP: Inserts → **B097** -, CBN → **B167**

C-CER/L: Inserts → **B418** -

Lever lock type boring bar, for negative 80° rhombic inserts

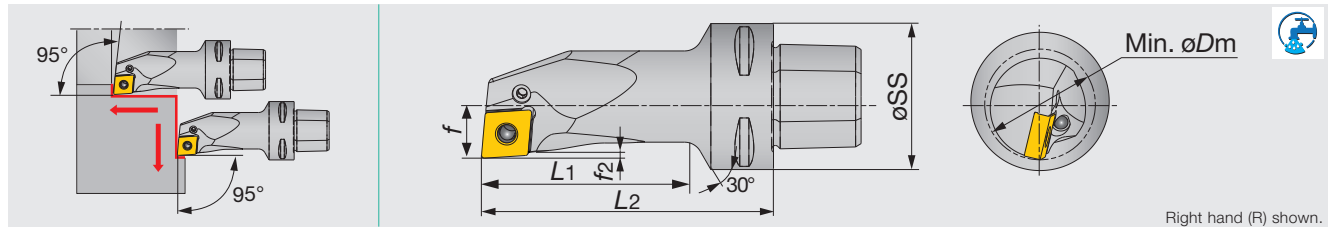

Right hand (R) shown.

Metric	Min. øDm	øSS	L2	L1	f	f2	rε	Insert
C4PCLNR/L17080-12	32	40	80	58.5	17	1.6	0.8	CN**1204...

SPARE PARTS

Designation	Lever	Clamping screw	Wrench
C4PCLNR/L17080-12	LCL43N	LCS43	P-2.5

C-ADUNR/L

Turning a double-clamp boring bar, for negative 55° rhombic inserts

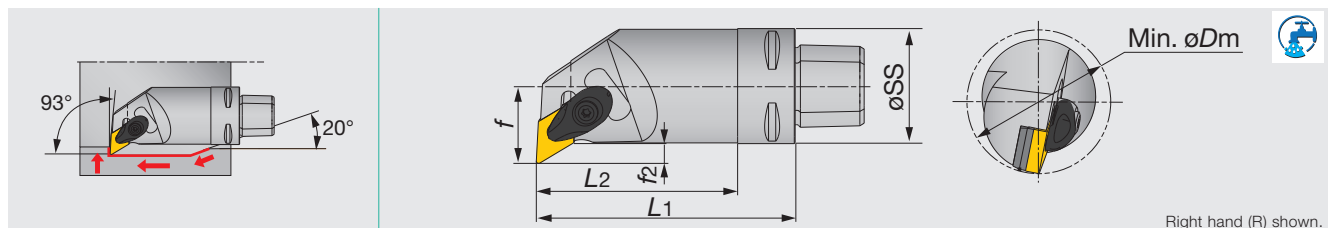

Right hand (R) shown.

Metric	Min. øDm	øSS	L1	L2	f	f2	rε	Insert
C4ADUNR20070-15	38	40	70	50	20	5	0.8	DN**1504...
C4ADUNR27090-15	50	40	90	-	27	7	0.8	DN**1504...

SPARE PARTS

Designation	Clamp	Clamp screw	Shim	Shim screw	Spring	Spring pin	Wrench
C4ADUNR**-15	ACP4S	ACS-5W	ASD423(04)	CSTB-3.5	BP-7	SP-2.5	T-15F

option : ASD423 (Shim for DN**1506**)

C-PDUNR/L

Lever lock type boring bar, for negative 55° rhombic inserts

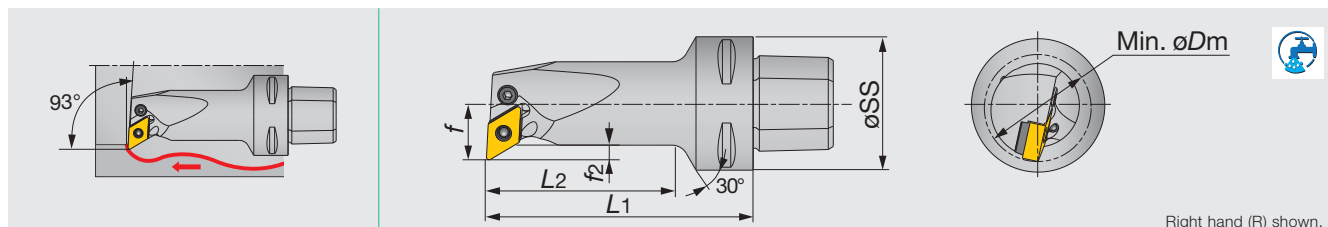

Right hand (R) shown.

Metric	Min. øDm	øSS	L1	L2	f	f2	rε	Insert
C4PDUNR/L17080-11	32	40	80	58.5	17	4.4	0.8	DN**1104...

SPARE PARTS

Designation	Lever	Clamping screw	Shim	Spring	Wrench
C4PDUNR/L17080-11	LCL33L	LCS3	ELSD317BR	LSP3	P-2.5
C4PDUNR/L17080-11	LCL33L	LCS3	ELSD317BL	LSP3	P-2.5

Reference pages

C-PCLNR/L-IN: Inserts → B052 -, CBN → B165 -, PCD → B178

C-ADUNR/L: Inserts → B063 -, CBN → B165 -, PCD → B178

C-PDUNR/L: Inserts → B063 -



TUNG CAP

C-CHFVR/L

TungCut shank for perpendicular toolholders for CAER/L & CAFR/L blades

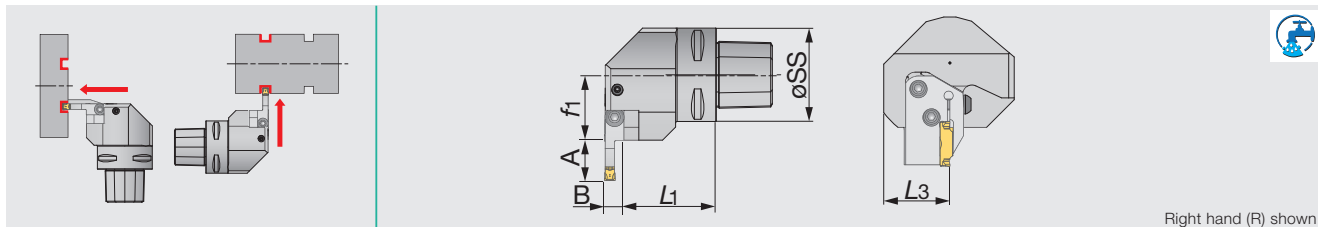

Right hand (R) shown.

Metric	øSS	L1	L3	f1	A	B
C4CHFVR/L27050N ⁽²⁾	40	42.5	36	27	Table*	Table*
C5CHFVR/L35060N ⁽²⁾	50	49.5	36	35	Table*	Table*
C6CHFVR/L45065 ⁽¹⁾	63	54.5	41	45	Table*	Table*
C6CHFVR/L45065N ⁽²⁾	63	54.5	41	45	Table*	Table*

(1) Applicable for 3 MPa pressure coolant. (2) Applicable for 7 MPa pressure coolant.

*See the table below for offset dimensions

SPARE PARTS

Designation	Coolant parts	Coolant parts 1	Clamping screw	Wrench
C5CHFV*35060N	SATZ-M10X1-M5	-	CSHB-6-A	P-4
C6CHFV*45065	CNZ125	PNZ5	CSHB-6-A	P-4
C6CHFV*45065N	SATZ-M10X1-M5	-	CSHB-6-A	P-4

Combination of blade and toolholder

Toolholder	Blade			
	CAER...	CAEL...	CAFR...	CAFL...
CHFVR...	●	●	●	●
CHFVL...	●			●

● : Correspondence

TUNG CAP

C-CHSR/L

TungCut shank for toolholders for CAER/L & CAFR/L blades

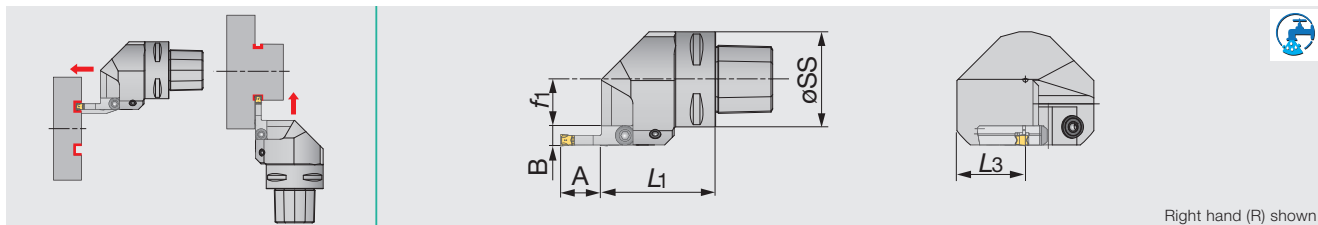

Right hand (R) shown.

Metric	øSS	L1	L3	f1	A	B
C4CHSR/L27050N ⁽²⁾	40	50	36	16.5	Table*	Table*
C5CHSR/L35060 ⁽¹⁾	50	60	36	24.5	Table*	Table*
C5CHSR/L35060N ⁽²⁾	50	60	36	24.5	Table*	Table*
C6CHSR/L45065N ⁽²⁾	63	65	41	34.5	Table*	Table*

(1) Applicable for 3 MPa pressure coolant. (2) Applicable for 7 MPa pressure coolant.

*See the table below for offset dimensions

SPARE PARTS

Designation	Coolant parts	Coolant parts 1	Clamping screw	Wrench
C4CHS*27050N	SATZ-M8X1-M3	-	CSHB-6-A	P-4
C5CHS*35060	CNZ125	PNZ5	CSHB-6-A	P-4
C*CHS**506*N	SATZ-M10X1-M5	-	CSHB-6-A	P-4

Combination of blade and toolholder

Toolholder	Blade			
	CAER...	CAEL...	CAFR...	CAFL...
CHSR...	●			●
CHSL...		●	●	

● : Correspondence

*Table: Offset dimensions for blade

Application	Blade	A	B
For external grooving	CAER/L-3T16	16	10.4
	CAER/L-4T16	16	10.5
	CAER/L-5T20	20	10.5
	CAER/L-6T20	20	10.5
	CAFR/L-3T12-*	12	10.4
For face grooving	CAFR/L-4T16-*	16	10.5
	CAFR/L-5T20-*	20	10.5
	CAFR/L-6T20-*	25	10.5

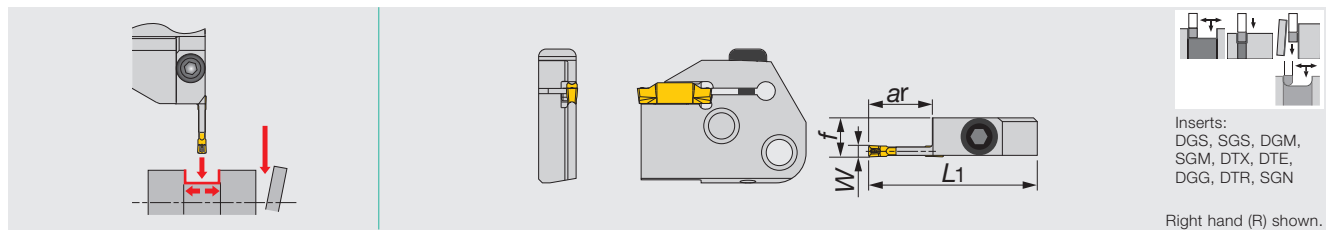

Inch	Seat size	ar	W	L1	f	Shank
CAER/L-3T16	3	0.630	0.118	1.772	0.409	CHSR/L, CHRVL/R
CAER/L-4T16	4	0.630	0.157	1.772	0.413	CHSR/L, CHRVL/R
CAER/L-5T20	5	0.787	0.196	1.929	0.413	CHSR/L, CHRVL/R
CAER/L-6T20	6	0.787	0.236	1.929	0.413	CHSR/L, CHRVL/R

SPARE PARTS

Designation	Screw	Wrench
CAER/L...	BHM6-20-A	P-4

CAFR/L

Blades for face grooving & turning

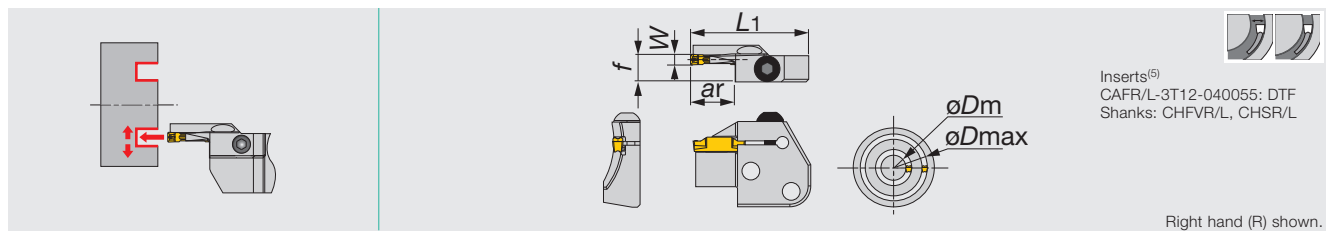

Inch	Seat size	øDm	øDmax	ar	W	L1	f
CAFR/L-3T12-040055	3	1.575	2.165	0.472	0.118	1.772	0.409
CAFR/L-3T12-055075	3	2.165	2.953	0.472	0.118	1.772	0.409
CAFR/L-3T12-075100	3	2.953	3.937	0.472	0.118	1.772	0.409
CAFR/L-3T12-100140	3	3.937	5.512	0.472	0.118	1.772	0.409
CAFR/L-3T12-140200	3	5.512	7.874	0.472	0.118	1.772	0.409
CAFR/L-4T16-050070	4	1.969	2.756	0.630	0.157	1.772	0.413
CAFR/L-4T16-070100	4	2.756	3.937	0.630	0.157	1.772	0.413
CAFR/L-4T16-100150	4	3.937	5.906	0.630	0.157	1.772	0.413
CAFR/L-4T16-150250	4	5.906	9.843	0.630	0.157	1.772	0.413
CAFR/L-5T20-055080	5	2.165	3.15	0.787	0.196	1.929	0.413
CAFR/L-5T20-080120	5	3.15	4.724	0.787	0.196	1.929	0.413
CAFR/L-5T20-120180	5	4.724	7.087	0.787	0.196	1.929	0.413
CAFR/L-5T20-180300	5	7.087	11.811	0.787	0.196	1.929	0.413
CAFR/L-5T20-300000	5	11.811	∞	0.787	0.196	1.929	0.413
CAFR/L-6T25-060090	6	2.362	3.543	0.984	0.236	2.165	0.413
CAFR/L-6T25-090150	6	3.543	5.906	0.984	0.236	2.165	0.413
CAFR/L-6T25-150250	6	5.906	9.843	0.984	0.236	2.165	0.413
CAFR/L-6T25-250400	6	9.843	15.748	0.984	0.236	2.165	0.413

- (1) When groove depth is beyond the value of insert full length -0.059", single sided insert is recommended.
- (2) The value "f" is the dimension when the insert with groove width (W) in the above table is attached.
- (3) Not applicable for CAFR/L-3T12-040055.
- (4) Seat sizes of DTF are only 3 and 4.
- (5) Min. diameter øDm of DTE, DGS and DGM insert.

SPARE PARTS

Designation	Screw	Wrench
CAFR/L	BHM6-20-A	P-4







Reference pages

CAER/L, CAFR/L: Inserts → **C083** -





INSERT APPLICATION

Insert	Application						
	Grooving			Parting	Turning		
	External	Internal	Face		External	Internal	Face
							
DGM / SGM	●		●	●			
DGS / SGS	●		●	●			
DTE	●		●		●		●
DGG	●		●				
DGE	●						
DTX	●	●	●	●	●	●	●
DTI		●				●	
DGIM / DGIS		●					
DTF			●				●
DTR	●		●		●		●
DTIU	● Undercutting	● Undercutting					
DTA					● AI wheel machining	● AI wheel machining	
SGN	●						

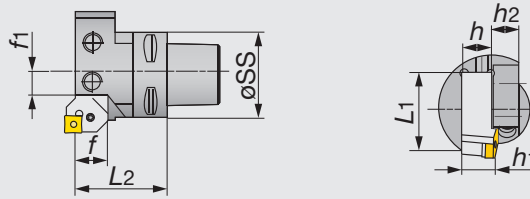

Left hand (L) shown.

Metric	øSS	f1	L2	f	h1	h2	h	L1
C3ADE-16R/L	32	17	45	16	16	26	16	45
C4ADE-20R/L	40	8	49.2	20	20	26	20	57
C5ADE-20R/L	50	8	55.2	20	20	20	20	57

- Regular shank should be shortened.
- Applicable for 10 MPa pressure coolant

C-ASHA

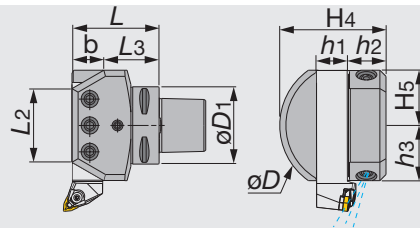

Metric	øD1	h1	b	L	L2	L3	h3	H5	h2	H4	øD
C5ASHA20	50	20	20	58	46	38	38	38	31.5	76.5	90
C6ASHA20	63	20	20	60	46	40	38	38	31.5	76.5	90
C6ASHA25	63	25	25	71	61	46	45	45	31.6	86.5	110

- Applicable for 10 MPa pressure coolant

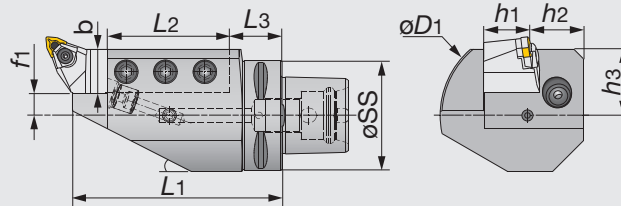

Left hand (L) shown.

Inch	øSS	L1	L2	L3	f1	h1	b	h2	h3	øD1
C6ASHR/L3/4X1	2.480	3.937	2.5	1.044	0.4	0.75	0.8	1	1.181	3.543
C6ASHR/L1X1	2.480	4.724	2.8	1.181	0.5	1	1	1	1.496	3.937
C8 ASHR/L 1 1/4 1	3.150	5.512	3.74	1.378	0.325	1.25	1.25	1.26	1.575	4.331

- Regular shank should be shortened.
- Applicable for 10 MPa pressure coolant



TUNGCAP

C-ADES

Adapters for square shank toolholders

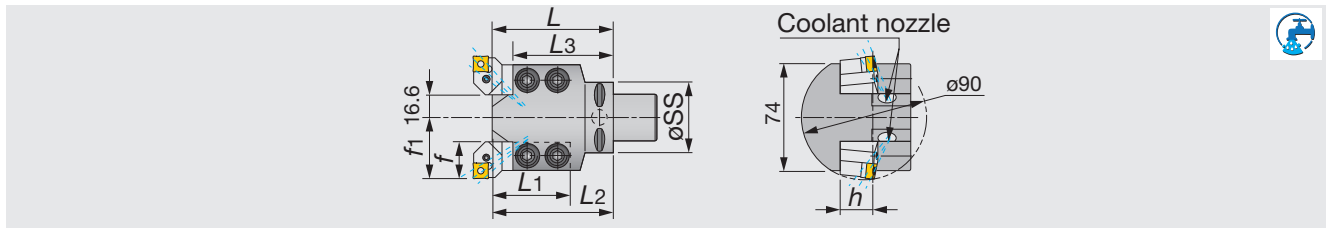

Metric	øSS	f1	L2	L	L3	h	f	L1
C4ADES-20	40	41.6	98	85	71	20	25	67
C5ADES-20	50	41.6	98	85	71	20	25	67

- Regular shank should be shortened.
- Applicable for 10 MPa pressure coolant

C-ASHR/L-45

Adapters for square shank toolholder with 45° angle

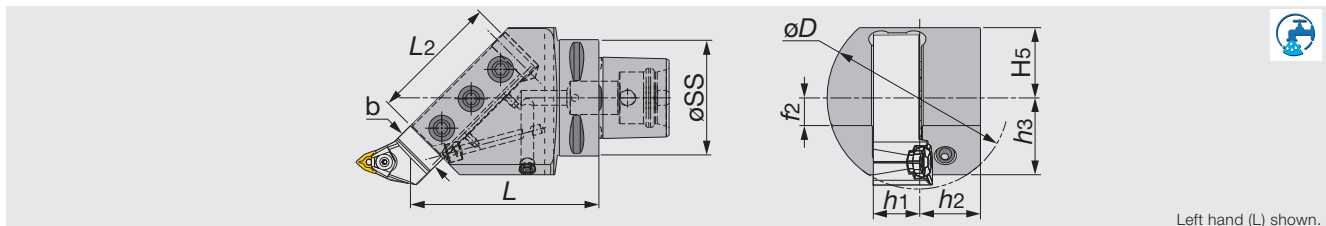

Metric	øSS	h1	b	L2	L	h2	h3	H5	f2	øD
C5ASHR/L20-45	50	20	20	-	127	26	36	31.5	15	72
C6ASHR/L20-45	63	20	20	70	102	33	41.6	38	15	72
C6ASHR/L25-45	63	25	25	70	102	33	41.6	38	15	100

- Regular shank should be shortened.
- Applicable for 10 MPa pressure coolant

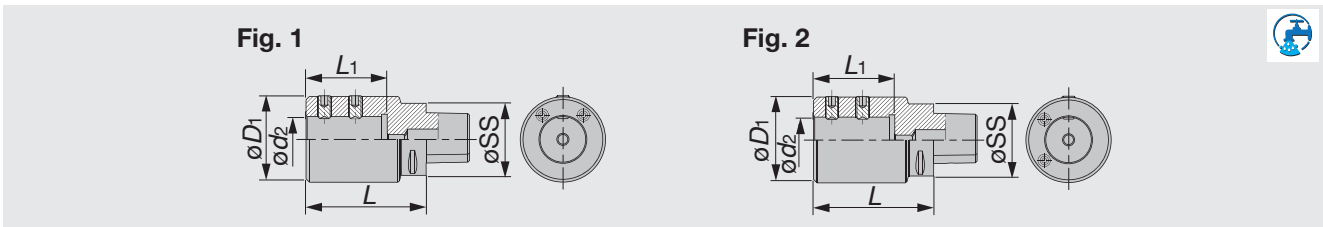

Inch	øSS	ød2	øD1	L	L1	Fig.
C6ABB1X2.36	2.480	1.000	2.480	3.937	2.362	2
C6ABB11/2X2.75	2.480	1.500	2.953	4.134	2.756	1

* Use the appropriate outlet screw according to the tool setup.
 • Applicable for 7 MPa pressure coolant

SPARE PARTS

Designation	Clamp screw		Coolant outlet screw for internal supply	Coolant outlet screw for external supply
	Used on A-type sleeves	Used on B-type sleeves		
C6ABB1X2.36	SCREW1/2-20X.500EM	HSSS3/8-24X0.250CUP.P	SRM10X6DIN913	SRM6X8DIN913
C6ABB11/2X2.75	SCREW1/2-20X.500EM	HSSS1/2-20X1.251/2DOGP	SRM10X6DIN913	SRM6X8DIN913

SC

Sleeves for C-ABB adaptors

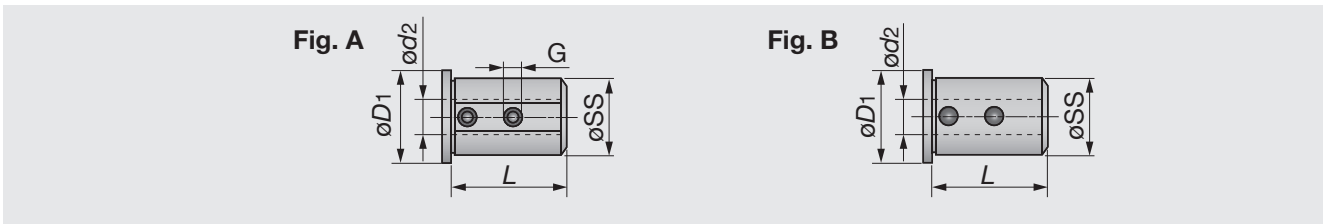

Inch	øSS	ød2	øD1	L	G	Fig.
SC 1-1/2T.250A	1.5	0.25	1.811	2.283	M6	A
SC 1-1/2T.312A	1.5	0.312	1.811	2.283	M6	A
SC 1-1/2T.375A	1.5	0.375	1.811	2.283	M8	A
SC 1-1/2T.500A	1.5	0.5	1.811	2.283	M9	A
SC 1-1/2T.625B	1.5	0.625	1.811	2.283	-	B
SC 1-1/2T.750B	1.5	0.75	1.811	2.283	-	B
SC 1-1/2T1.000B	1.5	1	1.811	2.283	-	B
SC 1-1/2T1.250B	1.5	1.25	1.811	2.283	-	B



TUNGSCAP

C-ADI

Adaptors for boring bars

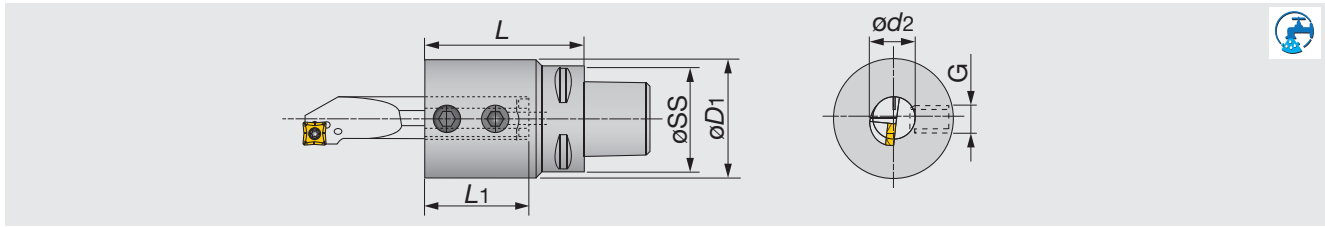

Metric	øSS	L	L1	ød2	øD1	G
C4ADI10	40	50	20	10	36	M6
C4ADI12	40	50	24	12	36	M8
C4ADI16	40	50	32	16	36	M8
C4ADI20	40	60	35	20	36	M10
C4ADI25	40	70	45	25	54	M12
C5ADI10	50	60	26	10	36	M6
C5ADI12	50	60	26	12	36	M8
C5ADI16	50	60	32	16	36	M8
C5ADI20	50	60	40	20	36	M10
C5ADI25	50	70	50	25	54	M12
C5ADI32	50	100	76	32	68	M12
C6ADI12	60	65	36	12	36	M8
C6ADI16	60	65	36	16	36	M8
C6ADI20	60	65	40	20	36	M10
C6ADI25	60	76	51	25	54	M12
C6ADI32	60	100	76	32	68	M12
C6ADI40	60	100	76	40	98	M12
C6ADI50	60	115	76	50	98	M12
C8ADI12	80	70	36	12	36	M8
C8ADI16	80	70	36	16	36	M8
C8ADI20	80	70	40	20	36	M10
C8ADI25	80	80	51	25	54	M12
C8ADI32	80	110	86	32	68	M12
C8ADI40	80	115	86	40	98	M12
C8ADI50	80	115	86	50	98	M12

- Applicable for 7 MPa pressure coolant

C-TBK-R/L

Adaptors for parting and grooving blades

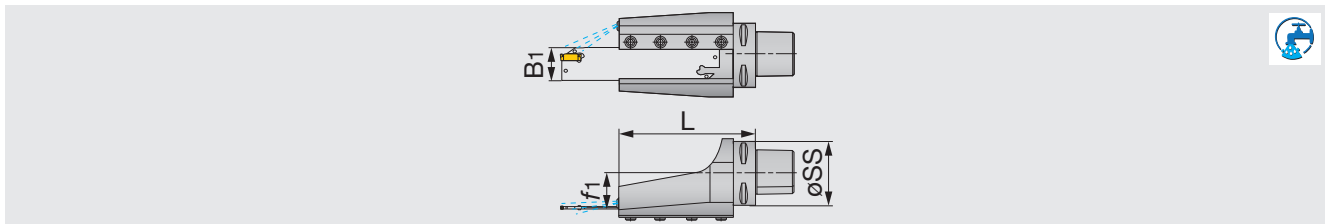

Metric	øSS	f1	L	B1
C6TBK-32R/L	63	32	138	32
C8TBK-32R	80	40.5	147	32
C8TBK-52R	80	40.5	161	52

- Applicable for 3 MPa pressure coolant

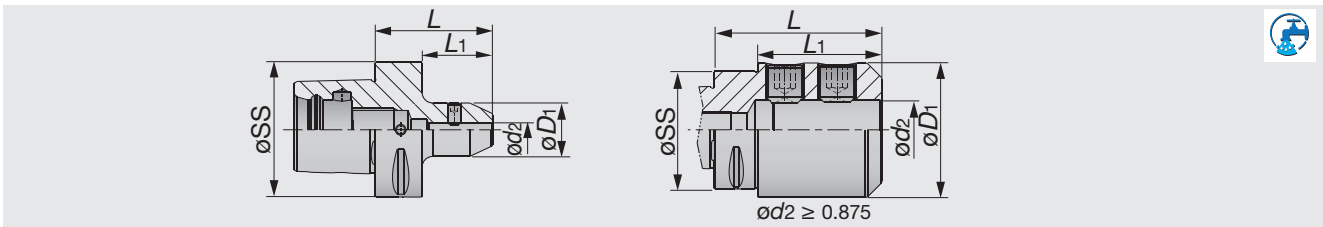

Inch	øSS	ød2	øD1	L	L1
C6EM1/4X2.165	2.48	0.250	0.984	2.165	0.866
C6EM3/8X2.362	2.48	0.375	1.378	2.362	1.496
C6EM1/2X2.362	2.48	0.500	1.614	2.362	1.496
C6EM5/8X2.560	2.48	0.625	1.752	2.560	1.693
C6EM3/4X2.560	2.48	0.750	1.929	2.560	1.693

Inch	øSS	ød2	øD1	L	L1
C6EM7/8X3.189	2.48	0.875	2.047	3.189	2.480
C6EM1X3.347	2.48	1.000	2.559	3.347	2.480
C6EM11/4X3.500	2.48	1.250	2.795	3.500	2.634
C6EM11/2X3.500	2.48	1.500	2.992	3.500	2.634

• Applicable for 7 MPa pressure coolant





TUNGCAP

C-EM-E

Drill holders (DIN1835 Form E - whistle notch)

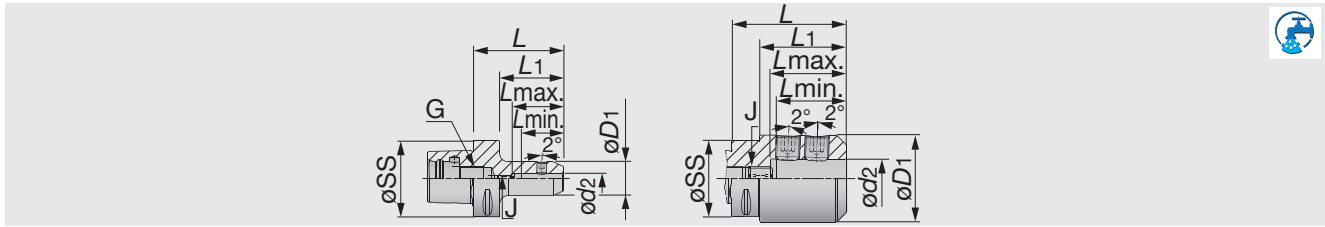

Metric	øSS	ød2	øD1	L	Lmin	Lmax	L1	J	G
C4EM06X70E	40	6	25	70	30	35	50	M5	M14
C4EM08X70E	40	8	28	70	35	43	50	M6	M14
C4EM10X70E	40	10	35	70	39	45	50	M8	M14
C4EM12X75E	40	12	42	75	44	49	55	M10	M14
C4EM14X75E	40	14	44	75	44	49	55	M10	M14
C5EM06X70E	50	6	25	70	30	35	50	M5	M16
C5EM08X70E	50	8	28	70	35	43	50	M6	M16
C5EM10X70E	50	10	35	70	39	45	50	M8	M16
C5EM12X75E	50	12	42	75	44	49	55	M10	M16
C5EM14X75E	50	14	44	75	44	49	55	M10	M16
C5EM16X80E	50	16	48	80	47	52	60	M12	M16
C5EM18X80E	50	18	50	80	47	52	60	M12	M16
C5EM20X85E	50	20	52	85	49	55	65	M16	M16
C6EM06X75E	63	6	25	75	30	36	53	M5	M20
C6EM08X75E	63	8	28	75	35	43	53	M6	M20
C6EM10X75E	63	10	35	75	39	46	53	M8	M20
C6EM12X80E	63	12	42	80	44	49	58	M10	M20
C6EM14X80E	63	14	44	80	44	49	58	M10	M20
C6EM16X85E	63	16	48	85	47	52	63	M12	M20
C6EM18X85E	63	18	50	85	47	52	63	M12	M20
C6EM20X85E	63	20	52	85	49	55	63	M16	M20
C6EM25X90E	63	25	65	90	54	60	68	M20	M20
C6EM32X95E	63	32	72	95	58	63	73	M20	M20
C8EM06X65E	80	6	25	65	30	36	35	M5	M20
C8EM08X65E	80	8	28	65	35	43	35	M6	M20
C8EM10X65E	80	10	35	65	39	46	35	M8	M20
C8EM12X70E	80	12	42	70	44	49	40	M10	M20
C8EM14X70E	80	14	44	70	44	49	40	M10	M20
C8EM16X75E	80	16	48	75	47	52	45	M12	M20
C8EM18X75E	80	18	50	75	47	52	45	M12	M20
C8EM20X80E	80	20	52	80	49	57	50	M16	M20
C8EM25X90E	80	25	65	90	54	60	60	M20	M20
C8EM32X95E	80	32	72	95	58	64	65	M20	M20

• Applicable for 7 MPa pressure coolant

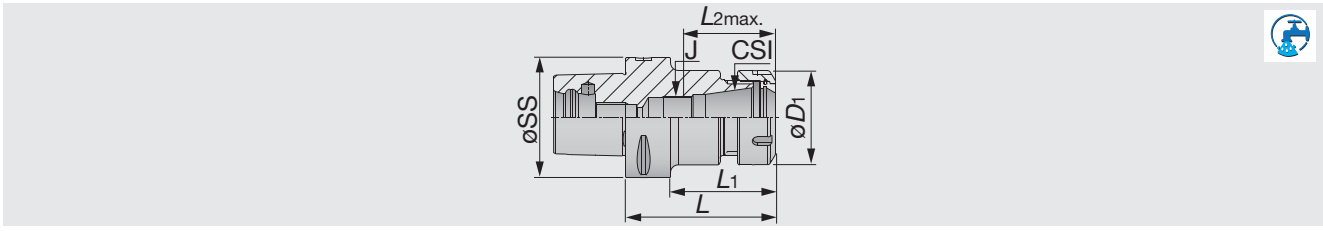

Inch	Range min.	Range max.	øSS	CSI	øD1	L	L1	J	L2max.	Inch	Range min.	Range max.	øSS	CSI	øD1	L	L1	J	L2max.
C4ER16X70	0.039	0.394	1.575	ER16	1.102	2.756	1.969	-	1.535	C6ER16X160	0.039	0.394	2.48	ER20	1.102	6.299	5.433	M12	2.067
C4ER20X35	0.039	0.512	1.575	ER20	1.339	1.378	1.063	-	1.567	C6ER20X060	0.039	0.512	2.48	ER20	1.339	2.362	1.496	M12	2.067
C4ER20X52	0.039	0.512	1.575	ER16	1.339	2.047	1.26	M10	1.638	C6ER20X100	0.039	0.512	2.48	ER20	1.339	3.937	3.071	M12	2.067
C4ER25X38	0.039	0.63	1.575	ER20	1.654	1.496	1.181	-	1.567	C6ER20X130	0.039	0.512	2.48	ER25	1.339	5.118	4.252	-	1.591
C4ER25X52	0.039	0.63	1.575	ER20	1.654	2.047	1.26	-	1.539	C6ER20X160	0.039	0.512	2.48	ER25	1.339	6.299	5.433	M16	2.559
C4ER32X54	0.079	0.787	1.575	ER25	1.969	2.126	1.339	-	1.705	C6ER25X060	0.039	0.63	2.48	ER25	1.654	2.362	1.496	M16	2.874
C5ER16X100	0.039	0.394	1.969	ER25	1.102	3.937	3.15	-	1.606	C6ER25X100	0.039	0.63	2.48	ER25	1.654	3.937	3.071	M16	2.874
C5ER16X130	0.039	0.394	1.969	ER32	1.102	5.118	4.724	-	1.839	C6ER25X130	0.039	0.63	2.48	ER32	1.654	5.118	4.252	-	1.882
C5ER20X055	0.039	0.512	1.969	ER16	1.339	2.165	1.378	M10	2.425	C6ER25X160	0.039	0.63	2.48	ER32	1.654	6.299	5.433	M22X1.5	2.339
C5ER20X100	0.039	0.512	1.969	ER16	1.339	3.937	3.15	M10	2.819	C6ER32X060	0.079	0.787	2.48	ER32	1.969	2.362	1.417	M22X1.5	2.732
C5ER20X130	0.039	0.512	1.969	ER20	1.339	5.118	4.724	-	1.547	C6ER32X100	0.079	0.787	2.48	ER32	1.969	3.937	3.071	M22X1.5	2.732
C5ER25X055	0.039	0.63	1.969	ER20	1.654	2.165	1.378	M12	2.067	C6ER32X130	0.079	0.787	2.48	ER40	1.969	5.118	4.252	-	2.165
C5ER25X100	0.039	0.63	1.969	ER20	1.654	3.937	3.15	M12	2.067	C6ER32X160	0.079	0.787	2.48	ER40	1.969	6.299	5.433	M28X1.5	2.362
C5ER32X057	0.079	0.787	1.969	ER25	1.969	2.244	1.417	-	1.594	C6ER40X065	0.118	1.024	2.48	ER40	2.48	2.559	1.457	M28X1.5	2.756
C5ER32X100	0.079	0.787	1.969	ER25	1.969	3.937	3.15	M16	2.559	C6ER40X100	0.118	1.024	2.48	ER32	2.48	3.937	3.071	-	1.882
C6ER16X100	0.039	0.394	2.48	ER32	1.102	3.937	3.071	-	1.858	C6ER40X130	0.118	1.024	2.48	ER32	2.48	5.118	4.252	M22x1.5	2.378
C6ER16X130	0.039	0.394	2.48	ER32	1.102	5.118	4.252	M22X1.5	2.339										

*Without V grooves, for manual use only.
 • Applicable for 10 MPa pressure coolant

(Option: Wrench for ER collet)



TUNGCAP

C-ER-M

Mini ER collet chucks holders (DIN 6499)

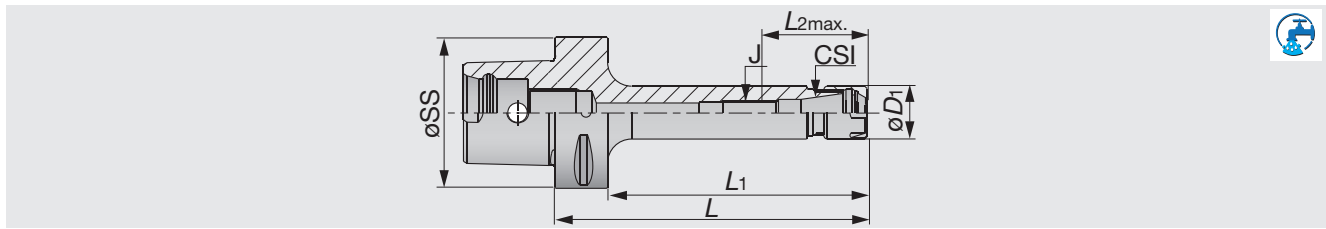

Inch	Range min.	Range max.	ϕSS	CSI	$\phi D1$	L	L1	J	L2max.
C4ER16X70M	0.02	0.394	1.575	ER16	0.866	2.756	1.969	M10	1.614
C5ER16X100M	0.02	0.394	1.969	ER16	0.866	3.937	3.15	M10	1.811
C5ER16X130M	0.02	0.394	1.969	ER16	0.866	5.118	4.724	M10	1.811
C6ER16X100M	0.02	0.394	2.48	ER16	0.866	3.937	3.071	M10	1.811
C6ER16X130M	0.02	0.394	2.48	ER16	0.866	5.118	4.252	M10	1.811
C6ER16X160M	0.02	0.394	2.48	ER16	0.866	6.299	5.433	M10	1.811

• Applicable for 10 MPa pressure coolant

(Option:Wrench for ER collet)

TUNGCAP

ADJ C-ER

ER collet chucks with center alignment

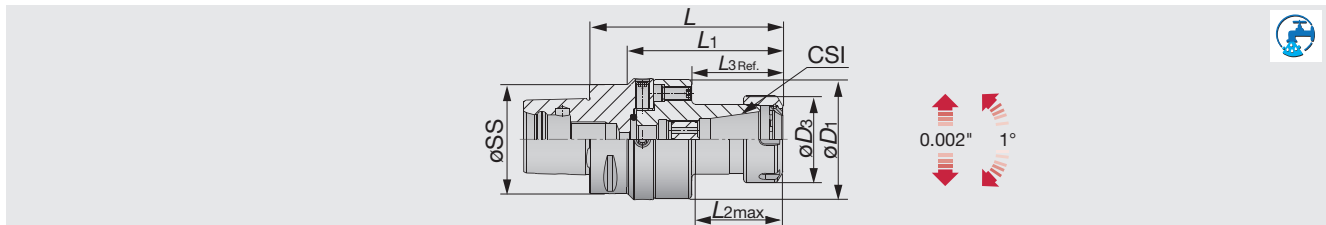

Inch	ϕSS	CSI	Range min.	Range max.	$\phi D1$	$\phi D3$	L	L1	L3	L2max.
ADJC5ER32	1.969	ER32	0.079	0.787	2.756	1.969	4.528	3.74	2.067	2.244
ADJC6ER32	2.48	ER32	0.079	0.787	2.756	1.969	4.39	3.524	2.067	2.244

• Applicable for 10 MPa pressure coolant

(Option:Wrench for ER collet)

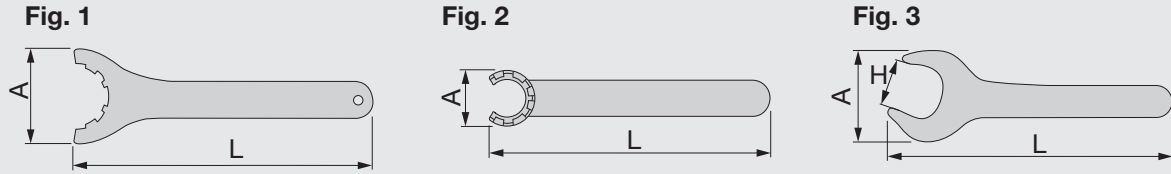

Metric	A	H	L	Fig.
WRENCHER11MINI	16.8	-	95	2
WRENCHER11	32	17	95	3
WRENCHER16MINI	22.5	-	117	2
WRENCHER16	42.8	25	143	3
WRENCHER20MINI	28	-	128	2
WRENCHER20	53.5	30	172	3
WRENCHER25MINI	29	-	120	2
WRENCHER25	70	-	207	1
WRENCHER32	78	-	255	1
WRENCHER40	95	-	285	1
WRENCHER50	110	-	350	1
WRENCHER20SHORTRING22	48	22	260	3
WRENCHER32SHORT	75	36	303	3
WRENCHER40SHORT	94	46	378	3

PRESET ER-JET (Preset screws)

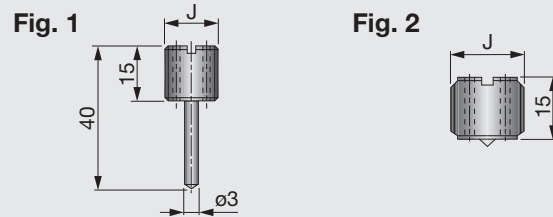

Metric	J	Fig.
PRESETER-JET8X1	M8X1.0	2
PRESETER-JET8X1.25	M8X1.25	2
PRESETER-JET10X1.5	M10X1.5	2
PRESETER-JET12X1	M12X1.0	2
PRESETER-JET12X1.75L	M12X1.75	1
PRESETER-JET12X1.75	M12X1.75	2
PRESETER-JET14X1	M14X1.0	2
PRESETER-JET16X2	M16X2	2
PRESETER-JET16X2L	M16X2	1
PRESETER-JET18X1	M18X1.0	2
PRESETER-JET18X1.5	M18X1.5	2
PRESETER-JET18X1.5L	M18X1.5	1
PRESETER-JET22X1.5	M22X1.5	2
PRESETER-JET22X1.5L	M22X1.5	1
PRESETER-JET28X1.5	M28X1.5	2

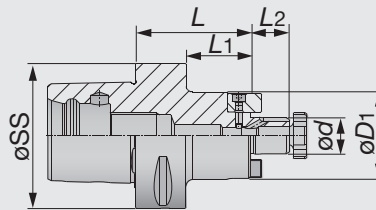

Inch	øSS	ød	øD1	L	L2	L1	Width of Key	Height of Key	Inch	øSS	ød	øD1	L	L2	L1	Width of Key	Height of Key
C6SEM3/4X1.377C	2.48	0.75	1.772	1.377	0.669	0.512	8	5	C6SEM1X3.937C	2.48	1.00	2.165	3.937	0.669	3.071	12	6.3
C6SEM3/4X3.937C	2.48	0.75	1.772	3.937	0.669	3.071	8	5	C6SEM11/4X2.362C	2.48	1.25	2.519	2.362	0.669	1.496	12.7	6
C6SEM1X1.457C	2.48	1.00	2.165	1.457	0.669	0.59	10	5.4	C6SEM11/2X2.362C	2.48	1.50	3.070	2.362	0.937	1.496	14	7

Metric	øSS	ød	øD1	L	L2	L1	Width of Key	Height of Key	Metric	øSS	ød	øD1	L	L2	L1	Width of Key	Height of Key
C4SEM16X32C	40	16	38	32	12	17	8	5	C6SEM27X100C	63	27	58	100	21	78	12	6.3
C4SEM16X55C	40	16	38	55	35	17	8	5	C6SEM31.75X60C	63	31.75	64	60	30	-	12.7	6
C4SEM22X40C	40	22	47	40	20	19	10	5.4	C6SEM32X60C	63	32	66	60	24	38	14	7
C4SEM22X55C	40	22	47	55	35	19	10	5.4	C6SEM38.1X60C	63	38.1	78	60	34	-	15.875	8
C5SEM16X35C	50	16	38	35	17	15	8	5	C6SEM40X60C	63	40	82	60	27	38	16	8
C5SEM16X70C	50	16	38	70	17	50	8	5	C8SEM16X50C	80	16	38	50	20	17	8	5
C5SEM22X35C	50	22	47	35	19	15	10	5.4	C8SEM16X100C	80	16	38	100	70	17	8	5
C5SEM22X70C	50	22	47	70	19	50	10	5.4	C8SEM22X50C	80	22	47	50	20	19	10	5.4
C5SEM25.4X37C	50	25.4	55	37	22	-	9.525	4.6	C8SEM22X100C	80	22	47	100	70	19	10	5.4
C5SEM27X40C	50	27	58	40	21	20	12	6.3	C8SEM25.4X50C	80	25.4	50	50	22	20	9.525	4.6
C5SEM31.75X60C	50	31.75	64	60	30	-	12.7	6	C8SEM27X50C	80	27	58	50	20	21	12	6.3
C5SEM32X40C	50	32	63	40	24	20	14	7	C8SEM27X100C	80	27	58	100	70	21	12	6.3
C6SEM16X50C	63	16	38	50	17	28	8	5	C8SEM31.75X50C	80	31.75	64	50	30	20	12.7	6
C6SEM16X100C	63	16	38	100	17	78	8	5	C8SEM32X50C	80	32	66	50	20	24	14	7
C6SEM22X50C	63	22	47	50	19	28	10	5.4	C8SEM32X100C	80	32	66	100	70	24	14	7
C6SEM22X100C	63	22	47	100	19	78	10	5.4	C8SEM38.1X50C	80	38.1	80	50	34	-	15.875	8
C6SEM25.4X37C	63	25.4	55	37	22	15	9.525	4.6	C8SEM40X60C	80	40	82	60	30	27	16	8
C6SEM27X60C	63	27	58	60	21	38	12	6.3									

• Applicable for 7 MPa pressure coolant

(Option:Wrench for lock Screw)

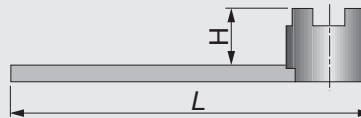
WRENCH SEM / DIN6368

Metric	Inner diameter of cutter body ø	Screw size	H	L
WRENCHM8SEMC16	16	M8	20	180
WRENCHM10SEMC22	22	M10	25	200
WRENCHM12SEMC27	25.4 / 27	M12	32	225
WRENCHM16SEMC32	31.75 / 32	M16	36	250
WRENCHM20SEMC40	38.1 / 40	M20	40	280
WRENCHM24SEMC50	50	M24	50	315

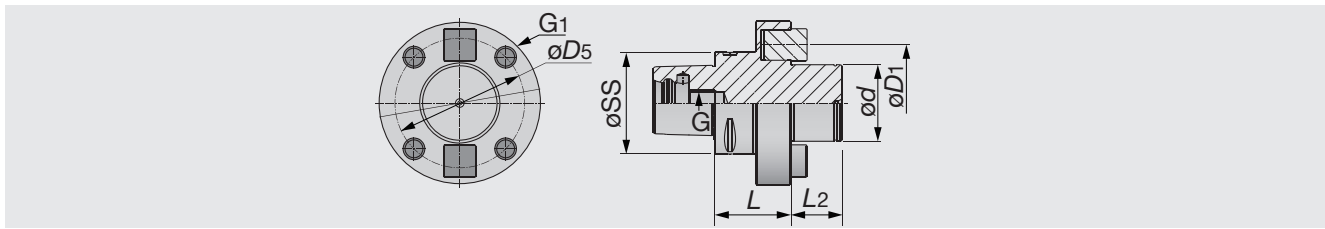

Metric	øSS	ød	L2	L	øD1	øD5	G1	G	Width of key	Height of key
C8FM60X60	80	60	20	40	128	101.6	M16	M20	25.4	12.4

TUNGFLEX

C-ODP

TungFlex modular tooling system (Screw clamping head holder)

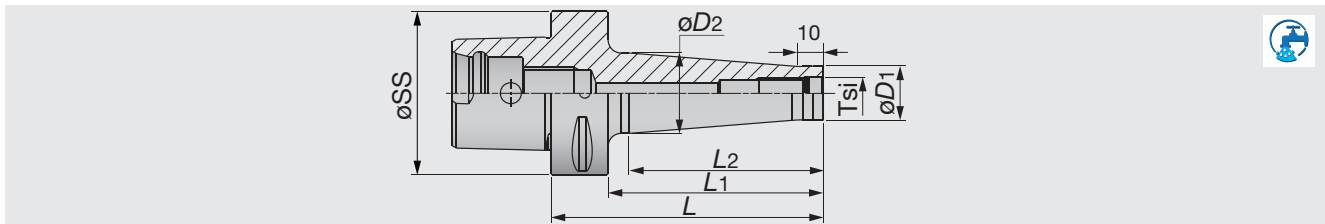

Inch	Tsi	øSS	øD1	øD2	L	L1	L2
C4ODP10X53	M10	1.575	0.709	0.906	2.087	1.299	0.906
C4ODP12X53	M12	1.575	0.827	1.024	2.087	1.299	0.906
C4ODP16X53	M16	1.575	1.142	1.339	2.087	1.299	0.906
C5ODP10X53	M10	1.969	0.709	0.768	2.087	1.299	0.984
C5ODP10X103	M10	1.969	0.709	1.102	4.055	3.268	2.953
C5ODP12X53	M12	1.969	0.827	0.925	2.087	1.299	0.984
C5ODP12X103	M12	1.969	0.827	1.220	4.055	3.268	2.953
C5ODP16X53	M16	1.969	1.142	1.339	2.087	1.299	0.984
C5ODP16X103	M16	1.969	1.142	1.417	4.055	3.268	2.953
C6ODP10X55	M10	2.480	0.709	0.768	2.165	1.299	0.984
C6ODP10X105	M10	2.480	0.709	1.102	4.134	3.268	2.953
C6ODP10X130	M10	2.480	0.709	1.260	5.118	4.252	3.937
C6ODP12X55	M12	2.480	0.827	0.925	2.165	1.299	0.984
C6ODP12X105	M12	2.480	0.827	1.220	4.134	3.268	2.953
C6ODP12X130	M12	2.480	0.827	1.417	5.118	4.252	3.937
C6ODP16X55	M16	2.480	1.142	1.339	2.165	1.299	0.984
C6ODP16X105	M16	2.480	1.142	1.339	4.134	3.268	2.953
C6ODP16X130	M16	2.480	1.142	1.614	5.118	4.252	3.937

• Applicable for 10 MPa pressure coolant



TUNG CAP

C-TUNGMAX

Power chuck holders

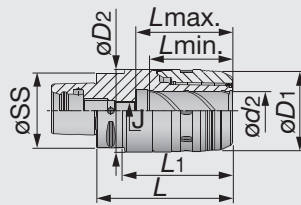

Inch	ϕSS	Range min.	Range max.	$\phi d2$	$\phi D1$	$\phi D2$	L	L1	Lmin	Lmax	J
C6MAXIN3/4X3.74	2.48	0.250	0.750	0.750	2.000	2.087	3.780	2.913	2.15	2.64	M16
C6MAXIN11/4X4.448	2.48	0.250	1.250	1.250	2.717	2.756	4.528	3.622	2.76	3.23	M16

• Applicable for 10 MPa pressure coolant

(Option : Wrench for TungMax collet)

SC-SEAL

SC sealed straight collets - inch

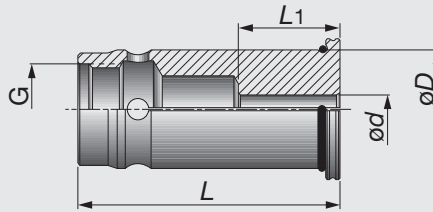

Inch	ϕd	ϕD	L	L1	G
SC3/4SEAL1/4	0.25	0.75	2.362	1.102	M16
SC3/4SEAL5/16	0.313	0.75	2.362	1.102	M16
SC3/4SEAL3/8	0.375	0.75	2.362	1.378	M16
SC3/4SEAL7/16	0.438	0.75	2.362	1.575	M16
SC3/4SEAL1/2	0.5	0.75	2.362	1.575	M16
SC3/4SEAL5/8	0.625	0.75	2.362	1.543	M16
SC1-1/4SEAL1/4	0.25	1.25	2.835	1.102	M24x1.5
SC1-1/4SEAL5/16	0.313	1.25	2.835	1.102	M24x1.5
SC1-1/4SEAL3/8	0.375	1.25	2.835	1.378	M24x1.5
SC1-1/4SEAL1/2	0.5	1.25	2.835	1.575	M24x1.5
SC1-1/4SEAL5/8	0.625	1.25	2.835	1.732	M24x1.5
SC1-1/4SEAL3/4	0.75	1.25	2.835	1.811	M24x1.5
SC1-1/4SEAL7/8	0.875	1.25	2.835	1.969	M24x1.5
SC1-1/4SEAL1	1	1.25	2.835	2.008	M24x1.5

• Applicable for 10 MPa pressure coolant

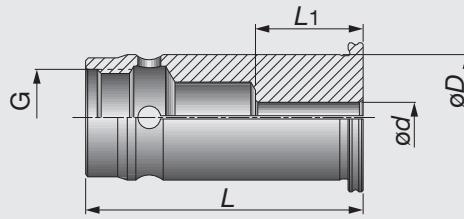

Inch	ød	øD	L	L1	G
SC3/4SPR1/4	0.25	0.75	2.362	1.102	M16
SC3/4SPR5/16	0.313	0.75	2.362	1.102	M16
SC3/4SPR3/8	0.375	0.75	2.362	1.378	M16
SC3/4SPR7/16	0.438	0.75	2.362	1.102	M16
SC3/4SPR1/2	0.5	0.75	2.362	1.102	M16
SC3/4SPR5/8	0.625	0.75	2.362	1.543	M16
SC1-1/4SPR1/4	0.25	1.25	2.835	1.102	M24x1.5
SC1-1/4SPR5/16	0.313	1.25	2.835	1.102	M24x1.5
SC1-1/4SPR3/8	0.375	1.25	2.835	1.378	M24x1.5
SC1-1/4SPR1/2	0.5	1.25	2.835	1.575	M24x1.5
SC1-1/4SPR5/8	0.625	1.25	2.835	1.732	M24x1.5
SC1-1/4SPR3/4	0.75	1.25	2.835	1.811	M24x1.5
SC1-1/4SPR7/8	0.875	1.25	2.835	1.969	M24X1.5
SC1-1/4SPR1	1	1.25	2.835	2.008	M24x1.5

PRESET SC CAP

Preset screw for SC collets

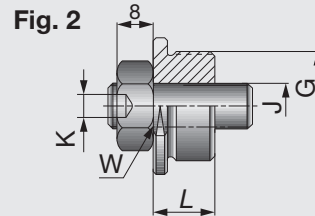
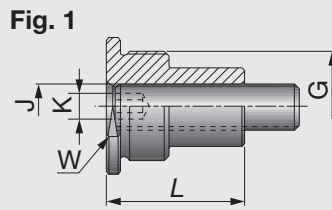

Metric	L	W	J	G	Range	K	CSI	Fig
PRESETSCCAP8x1.25L	28	16	M8X25	M16	6-8	4	SC20	1
PRESETSCCAP8x1.25	15	16	M8X25	M16	10-16	4	SC20	2
PRESETSCCAP10x1.5L	30	27	M10X30	M24X1.5	6-14	5	SC32	1
PRESETSCCAP10x1.5	13.5	27	M10X30	M24X1.5	16-25	5	SC32	2

Wrench

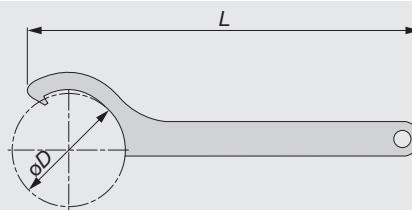

Metric	øD	L
WRENCHMAXIN20HOOK	26	16
WRENCHMAXIN32HOOK	68	16



SC collet extracting hook

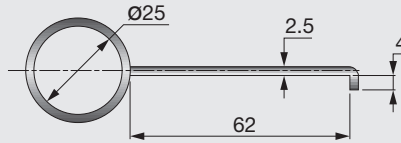

Metric
EXTRACTORSCCOLLETS

Collet
SC straight collets

Preset screws

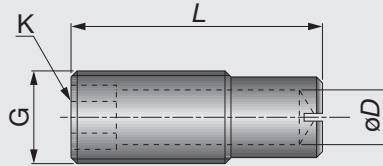

Metric	G	L	ØD	K
PRESETMAXIN16X30	M16	30	8	8
PRESETMAXIN16X44	M16	44	8	8
PRESETMAXIN20X55	M20	55	12	12

TUNGSHRINK

C-SRKIN

Thermal shrinking holders

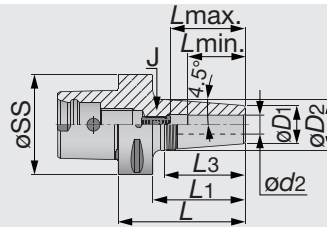

Inch	ØSS	ØD2	ØD1	ØD2	L	L1	L3	Lmin	Lmax	J
C6SRKIN1/4X3.150	2.48	0.25	0.827	1.063	3.15	2.363	1.5	0.98	1.42	M5
C6SRKIN5/16X3.150	2.48	0.312	0.827	1.063	3.15	2.363	1.5	0.98	1.42	M6
C6SRKIN3/8X3.150	2.48	0.375	0.945	1.26	3.15	2.363	2	1.22	1.65	M8
C6SRKIN1/2X3.150	2.48	0.5	0.945	1.26	3.15	2.363	2	1.42	1.85	M10
C6SRKIN5/8X3.35	2.48	0.625	1.063	1.339	3.35	2.563	1.75	1.54	1.97	M12
C6SRKIN3/4X3.35	2.48	0.75	1.299	1.654	3.35	2.563	2.25	1.61	2.05	M16
C6SRKIN1X3.55	2.48	1	1.732	2.087	3.55	2.763	2.25	1.85	2.28	M16
C6SRKIN11/4X3.75	2.48	1.25	1.732	2.087	3.75	2.963	2.25	1.85	2.28	M16

• Applicable for 10 MPa pressure coolant

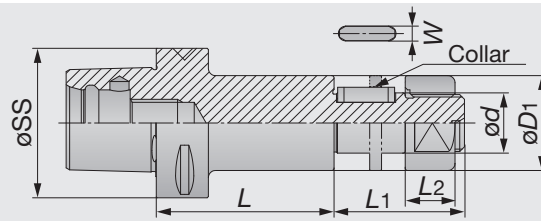

Metric	$\varnothing SS$	$\varnothing d$	L	$\varnothing D_1$	L_1	L_2	Width of key W	Height of key
C6SCA25.4-075	63	25.4	75	40	55	21	6.35	2.38
C6SCA31.75-075	63	31.75	75	46	60	26	7.92	3.17
C8SCA25.4-090	80	25.4	90	40	55	21	6.35	2.38
C8SCA31.75-090	80	31.75	90	46	60	26	7.92	3.17

• Collars for slot mills are not included.

SCA

Collar for slot milling holder

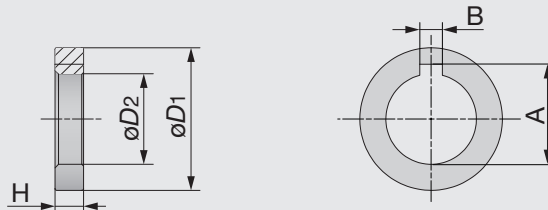

Metric	$\varnothing D_1$	$\varnothing D_2$	A	B	H
SCA25.4-02	40	25.4	28.1	6.35	3, 5, 7, 8, 10, 12, 14
SCA31.75-02	46	31.75	35.2	7.92	3, 5, 7, 8, 10, 12, 14



TUNGCAP

HSK-A-C/-T

Basic holders HSK shank

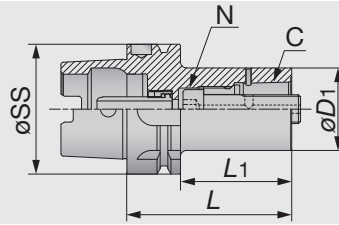

Metric	ϕSS	C	$\phi D1$	L	L1	N*	Key
HSK63A-C4-080T	63	C4	40	80	54	55	8
HSK63A-C5-090T	63	C5	50	90	64	95	10
HSK63A-C6-110T	63	C6	63	110	74	170	14
HSK100A-C6-110	100	C6	63	110	81	170	14
HSK100A-C8-120	100	C8	80	120	91	170	14

- Applicable for 7 MPa pressure coolant
- Option: Cooling tube wrench

*Recommended torque (N-m) for clamping

C-EX

Extension adapters

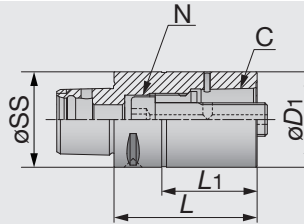

Metric	C	ϕSS	$\phi D1$	L	L1	N*	Key
C4EX-060	C4	40	40	60	80	65	8
C4EX-080	C4	40	40	80	60	65	8
C5EX-080	C5	50	50	80	60	95	10
C5EX-100	C5	50	50	100	80	95	10
C6EX-100	C6	63	63	100	78	170	14
C6EX-140	C6	63	63	140	118	170	14
C8EX-100	C8	80	80	100	70	170	14
C8EX-160	C8	80	80	160	130	170	14

- Applicable for 7 MPa pressure coolant

*Recommended torque (N-m) for clamping

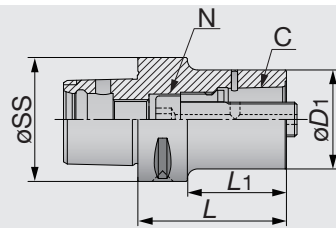

Metric	C	øSS	øD1	L	L1	N*	Key
C5-C4RE-060	C4	50	40	60	40	55	8
C5-C4RE-080	C4	50	40	80	60	55	8
C6-C4RE-080	C4	63	40	80	58	55	8
C6-C5RE-080	C5	63	50	80	58	95	10
C6-C5RE-120	C5	63	50	120	98	95	10
C8-C4RE-070	C4	80	40	70	40	55	8
C8-C5RE-080	C5	80	50	80	50	95	10
C8-C6RE-080	C6	80	63	80	50	170	14
C8-C6RE-120	C6	80	63	120	90	170	14

• Applicable for 7 MPa pressure coolant

*Recommended torque (N-m) for clamping

MULTI CLAMP (TungCap)

Multi-clamp fixture for TungCap

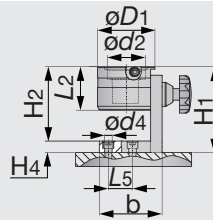





Metric	CSI	ød2	øD1	L2	H1	H2	H4	b	L5	ød4
MULTICLAMPC4	40	40.4	78	67	137.5	118.5	19	104	40	12.5
MULTICLAMPC5	50	50	85	72	142	123	19	104	40	12.5
MULTICLAMPC6	60	63	95	72	142	123	19	104	40	12.5
MULTICLAMPC8	80	80	130	90	178	159	19	144	85	12.5



Designation for clamping units

Fixed-type clamping unit

	For external (Tool setting direction cross X)	For internal (Tool setting direction straight Z)
Turning Unit	C□-DTO-□C-****-R/L	C□-DTI-□C-****-R/L
		
Driving Unit	C□-DDC-□C-****	C□-DDS-□C-****
		

Description of clamping unit for turning

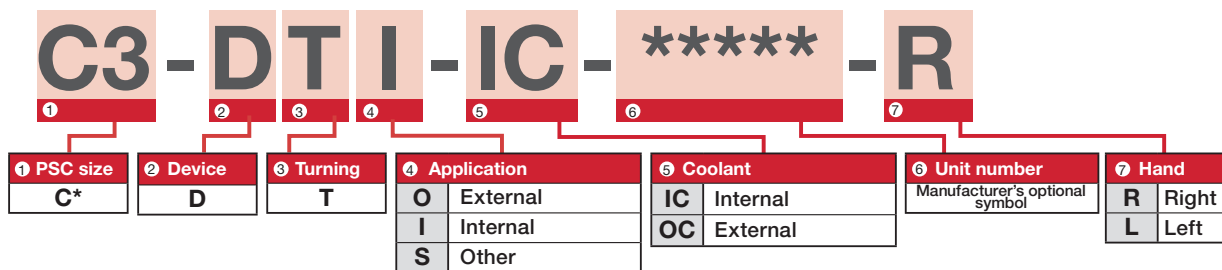

Description of clamping unit for driving

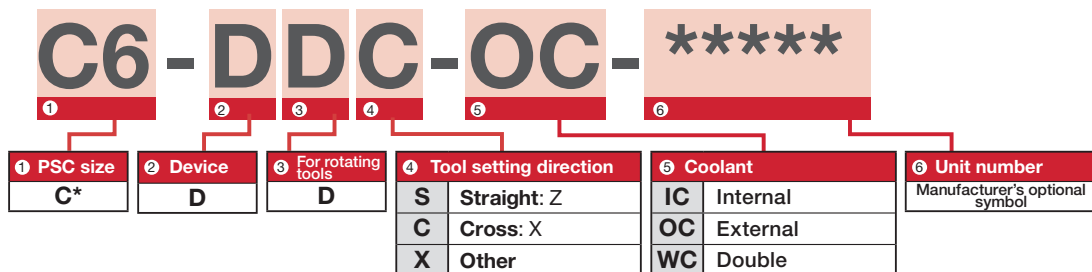



C-DTOSR/L

Manual clamping unit; Square shank

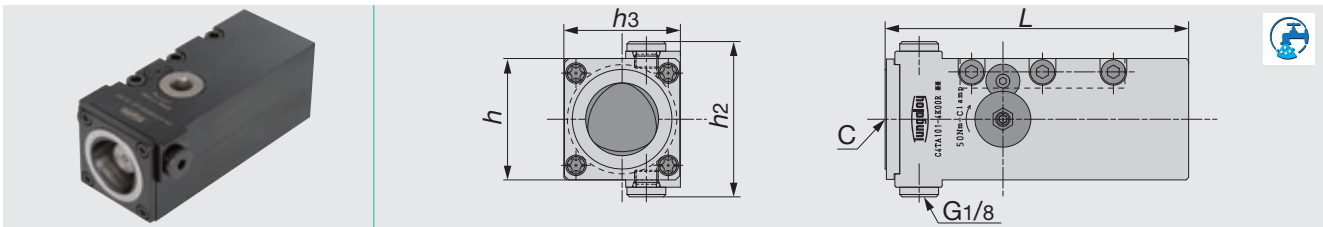

Metric	C	Turret size h	h3	h2	L	N*(N-m)
C3-DTOS4038R/L	C3	40	38	62	95	35
C4-DTOS5048R/L	C4	50	48	64	125	50
C5-DTOS6464R/L	C5	60	64	68	145	70

• Applicable for 7 MPa pressure coolant

* Recommend clamping torque.

C-DTIR

Manual clamping unit; Round shank

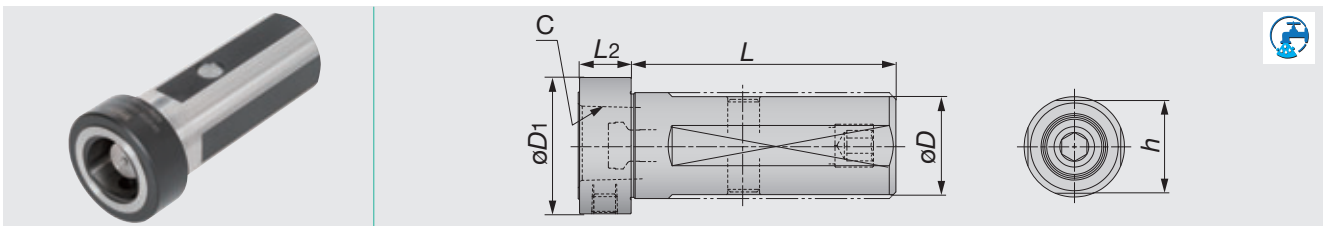

Metric	C	øD	øD1	h	L	L2	N*(N-m)
C3-DTIR-08018-D32	C3	32	46	30	80	18	35
C4-DTIR-10020-D40	C4	40	52	38	100	20	50
C4-DTIR-12020-D50	C4	50	52	48	120	20	50
C5-DTIR-12024-D50	C5	50	62	48	120	24	70

• Applicable for 7 MPa pressure coolant

* Recommend clamping torque.

C-DTOFR/L

Manual clamping unit; Fixed type

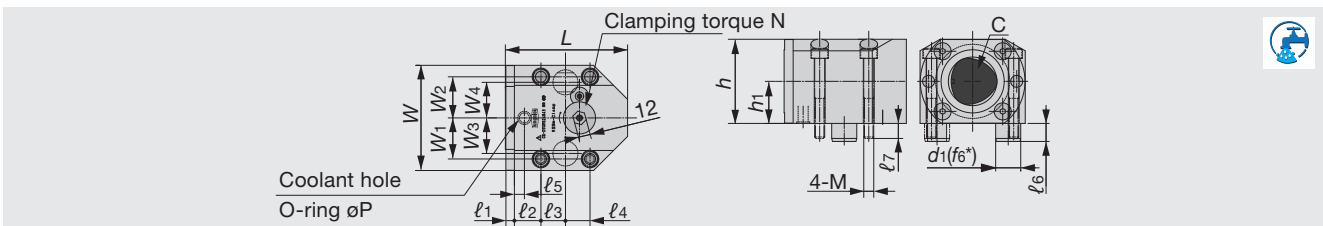

Metric	C	h	h1	L	W	W1	W2	W3	W4	l1	l2	l3	l4	l5	l6	l7	d1(f6*)	P	M	N*
C5-DTOFR/L32048	C5	64	32	100	92	35	31	8	19	21	7	11	15	20	P8	M10	70			
C6-DTOFR/L42060	C6	84	42	122	105	41	35.5	9	26.5	24.5	10	18	15	25	P10	M10	90			
C8-DTOFR/L50088	C8	100	50	146	133	55	46	12	33	43	13	19	20	32	P11	M12	130			

• Applicable for 7 MPa pressure coolant

* f6 tolerance: d20 & 25 = -0.022 / -0.033, d32 = -0.025 / -0.041
*Recommended torque (N-m) for clamping



Clamping units & tools for CNC lathes

Selection for External turning

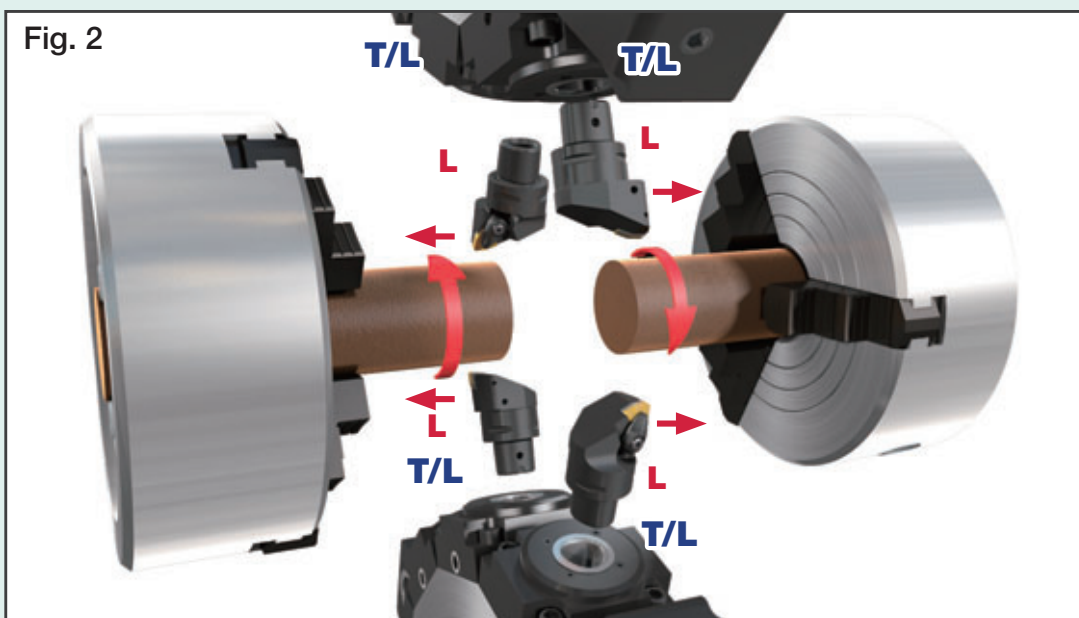
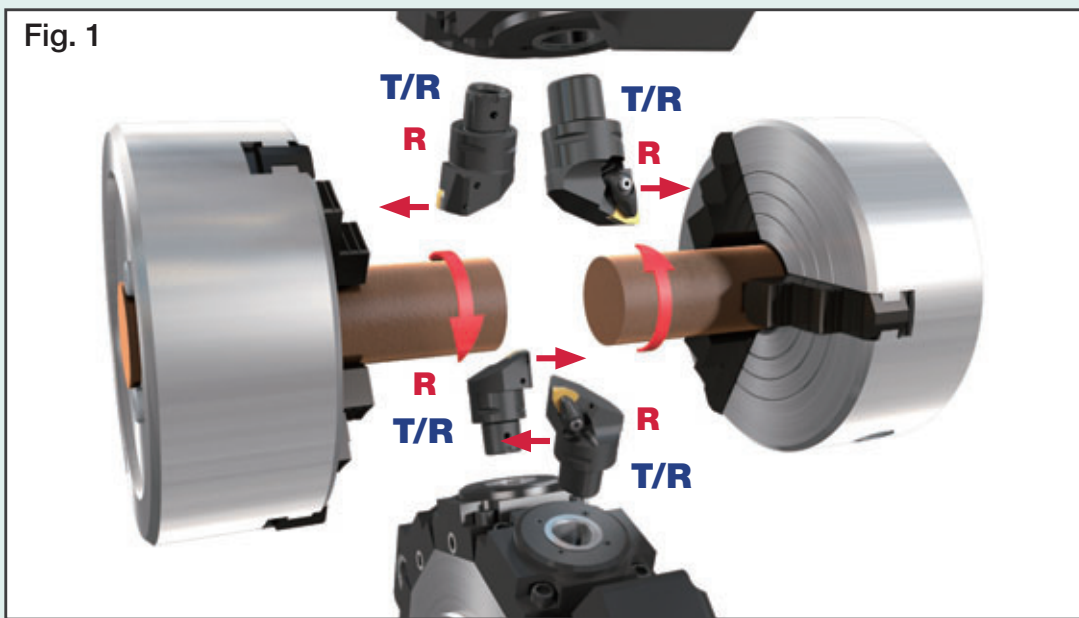

R: Right hand cutting tool, **L:** Left hand cutting tool

T/R: Right hand clamping unit, **T/L:** Left hand clamping unit

Clamping units & tools for CNC lathes



Selection for Internal turning

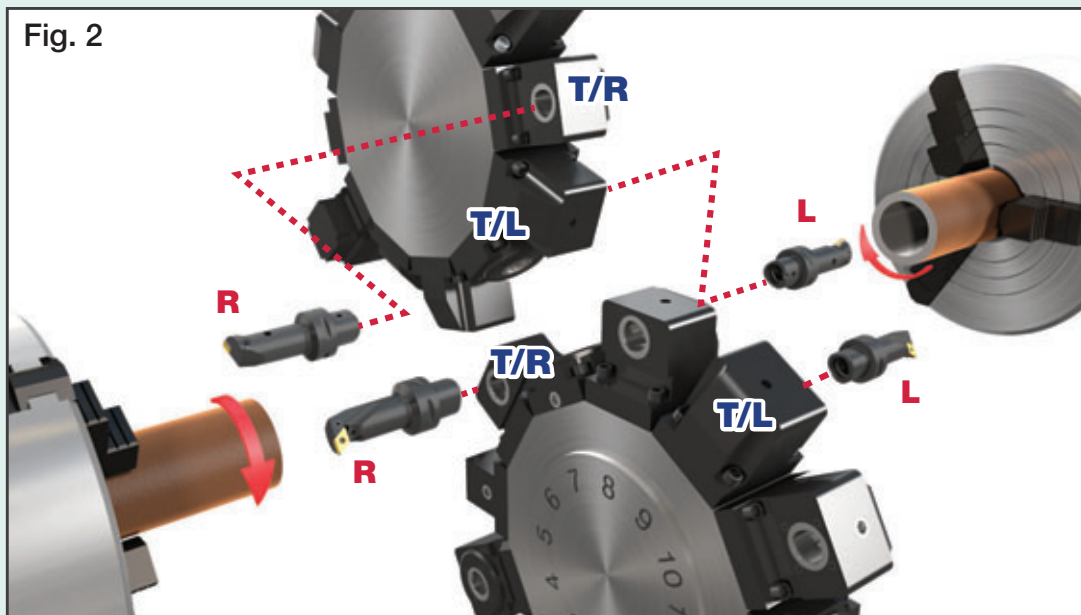
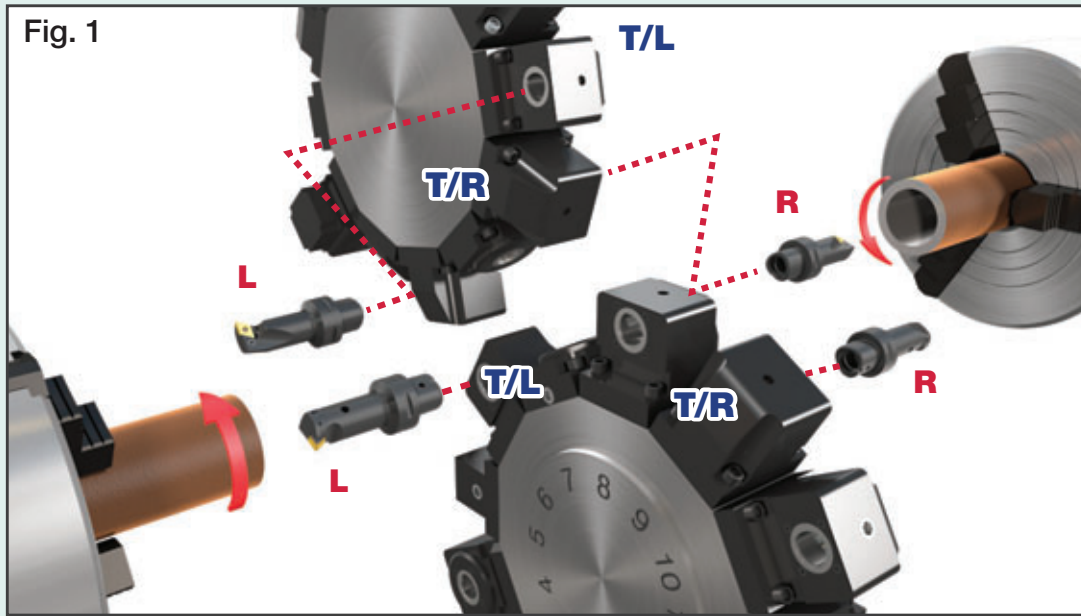

R: Right hand cutting tool, **L:** Left hand cutting tool

T/R: Right hand clamping unit, **T/L:** Left hand clamping unit



SPINJET

TJS-ER32

Coolant driven high speed compact spindles for ER32 collet chuck

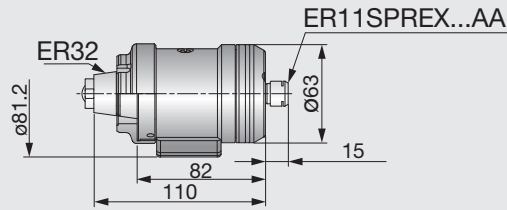

Description	Designation
Display (Optional parts)	TJSTSDDISPLAY
Nut	NUTER11GHS
Wrench for nut	WRENCHER11SMS
Wrench for setting	WRENCHDIA3.2X45

Metric	Max. tool diameter	Weight (kg)	Direction of tool rotation
TJS20KER32L	3.5	1.1	L
TJS20KER32R	3.5	1.1	R
TJS30KER32L	2.5	1.1	L
TJS30KER32R	2.5	1.1	R
TJS40KER32L	1.5	1.1	L
TJS40KER32R	1.5	1.1	R

- Max. tool shank diameter: ø6 mm
- Coolant pressure through machine spindle: Min. 2 MPa / Max. 4 MPa
- Min. flow rate: 12 l/min

SPINJET

TJS-HSK A63

Coolant driven high speed compact spindles with HSK A63 shanks

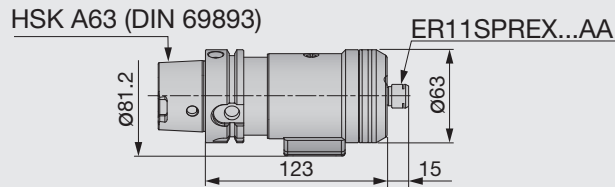

Description	Designation
Display (Optional parts)	TJSTSDDISPLAY
Nut	NUTER11GHS
Wrench for nut	WRENCHER11SMS
Wrench for setting	WRENCHDIA3.2X45

Metric	Max. tool diameter	Weight (kg)	Direction of tool rotation
TJS20KHSKA63L	3.5	1.6	L
TJS20KHSKA63R	3.5	1.6	R
TJS30KHSKA63L	2.5	1.6	L
TJS30KHSKA63R	2.5	1.6	R
TJS40KHSKA63L	1.5	1.6	L
TJS40KHSKA63R	1.5	1.6	R

- Max. tool shank diameter: ø6.0 mm
- Coolant pressure through machine spindle: Min. 2 MPa / Max. 4 MPa
- Min. flow rate: 12 l/min

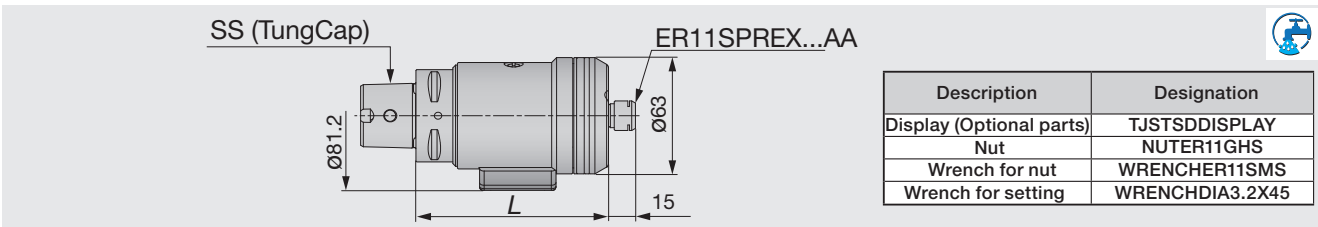

Description	Designation
Display (Optional parts)	TJSTDDISPLAY
Nut	NUTER11GHS
Wrench for nut	WRENCHER11SMS
Wrench for setting	WRENCHDIA3.2X45

Metric	SS	L	Max. tool diameter	Weight (kg)	Direction of tool rotation
TJS20KC5L	C5	104	3.5	1.5	L
TJS20KC5R	C5	104	3.5	1.5	R
TJS30KC5L	C5	104	2.5	1.5	L
TJS30KC5R	C5	104	2.5	1.5	R
TJS40KC5L	C5	104	1.5	1.5	L
TJS40KC5R	C5	104	1.5	1.5	R
TJS20KC6L	C6	106	3.5	1.65	L
TJS20KC6R	C6	106	3.5	1.65	R
TJS30KC6L	C6	106	2.5	1.65	L
TJS30KC6R	C6	106	2.5	1.65	R
TJS40KC6L	C6	106	1.5	1.65	L
TJS40KC6R	C6	106	1.5	1.65	R

- Max. tool shank diameter: ø6 mm
- Coolant pressure through machine spindle: Min. 2 MPa / Max. 4 MPa
- Min. flow rate: 12 l/min

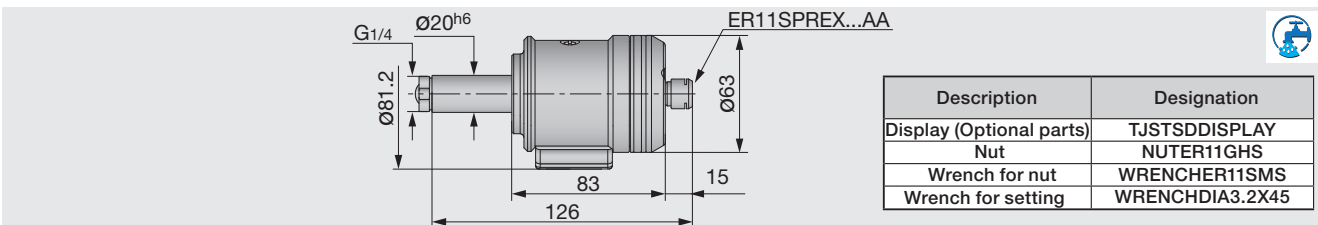

Description	Designation
Display (Optional parts)	TJSTDDISPLAY
Nut	NUTER11GHS
Wrench for nut	WRENCHER11SMS
Wrench for setting	WRENCHDIA3.2X45

Metric	Max. tool diameter	Weight (kg)	Direction of tool rotation
TJS20KST20L	3.5	1.1	L
TJS20KST20R	3.5	1.1	R
TJS30KST20L	2.5	1.1	L
TJS30KST20R	2.5	1.1	R
TJS40KST20L	1.5	1.1	L
TJS40KST20R	1.5	1.1	R

- Max. tool shank diameter: ø6 mm
- Coolant pressure through machine spindle: Min. 2 MPa / Max. 4 MPa
- Min. flow rate: 12 l/min



SPINJET

TJS-CAT

Coolant driven high speed compact spindles with CAT shanks

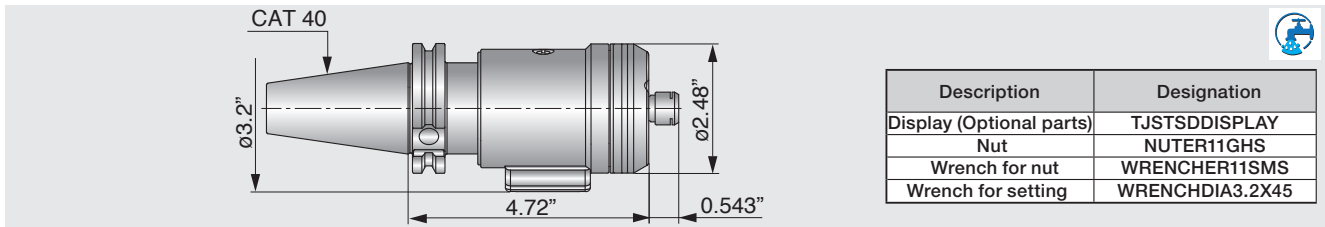

Description	Designation
Display (Optional parts)	TJSTSDDISPLAY
Nut	NUTER11GHS
Wrench for nut	WRENCHER11SMS
Wrench for setting	WRENCHDIA3.2X45

Inch	Max. tool diameter	Weight (lbs)	Direction of tool rotation
TJS-20K-CAT40L	ø0.138	3.528	L
TJS-20K-CAT40R	ø0.138	3.528	R
TJS-30K-CAT40L	ø0.1	3.528	L
TJS-30K-CAT40R	ø0.1	3.528	R
TJS-40K-CAT40L	ø0.06	3.528	L
TJS-40K-CAT40R	ø0.06	3.528	R

- Max. tool shank diameter: ø6 mm
- Coolant pressure through machine spindle:
Min. 2 MPa / Max. 4 MPa
- Min. flow rate: 12 l/min

SPINJET

Wireless RPM speed display

RPM speed display for SPINJET high speed spindles

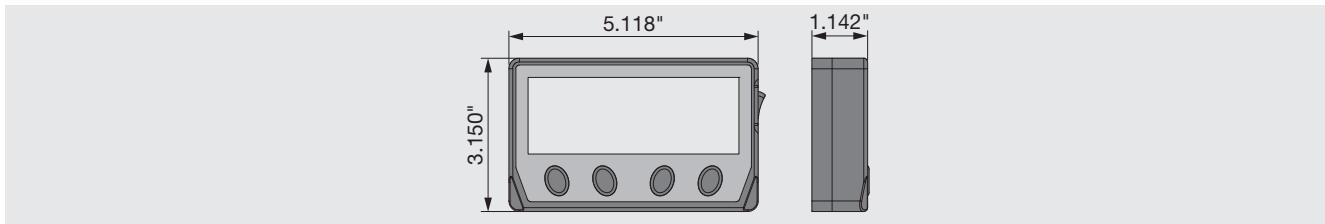

Inch	Machine
TJSTSDDISPLAY	TJS spindles

ER-SRK Shrink collet adapter

ER 11 shrink collet adapter for induction heating device

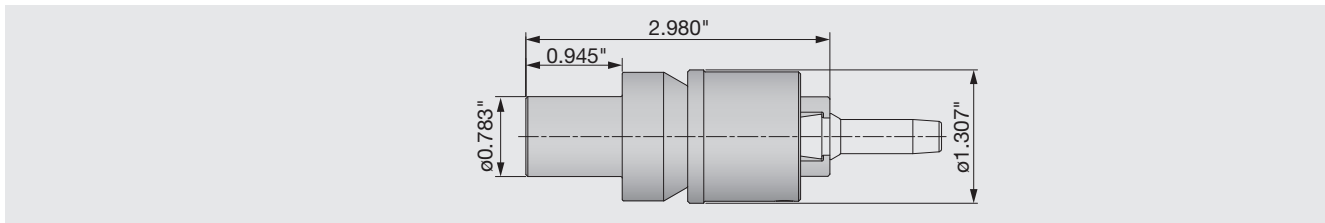

Inch	Machine
INDER11TOOLADAPTER	TJS spindles

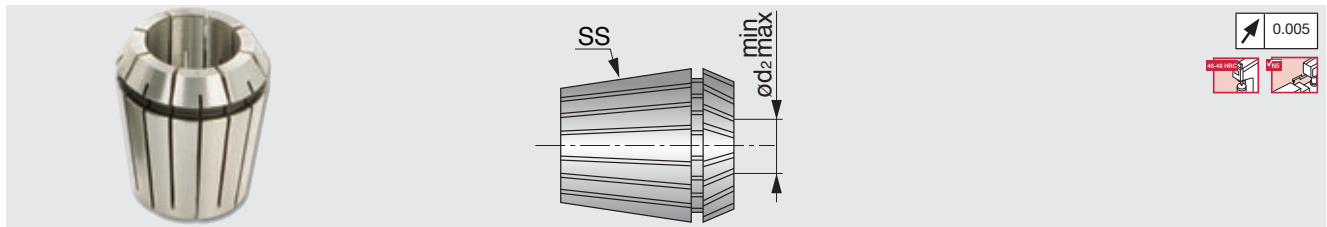

Metric	SS	ød2 min	ød2 max
ER11SPR0.5-1AA	ER11	0.5	1
ER11SPR1-2AA	ER11	1	2
ER11SPR2-3AA	ER11	2	3
ER11SPR3-4AA	ER11	3	4
ER11SPR4-5AA	ER11	4	5
ER11SPR5-6AA	ER11	5	6
ER11SPR6-7AA	ER11	6	7

AA collet run-out: 0.005 mm

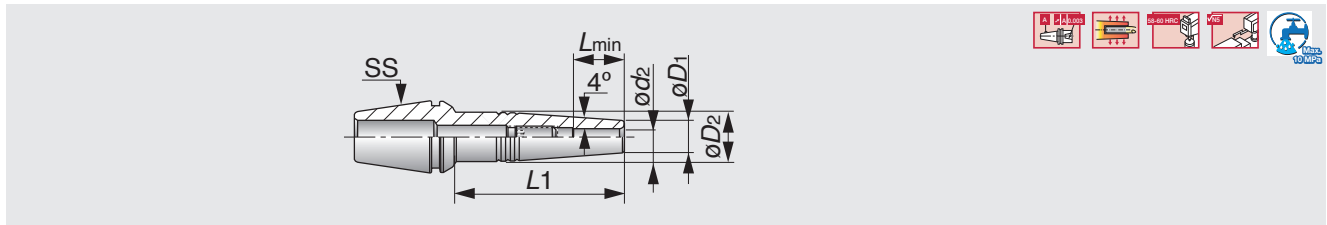

Metric	SS	ød2	L1	Lmin	øD2	øD1
ER11SRK3X10	ER11	3	10	9.5	8.5	7.6
ER11SRK3X25	ER11	3	25	11.5	8.5	7.6
ER11SRK4X10	ER11	4	10	9.5	8.5	7.6
ER11SRK4X25	ER11	4	25	11.5	8.5	7.6

• For carbide tools only

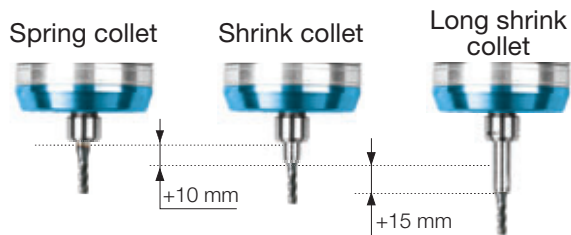

Nut and wrench for collets

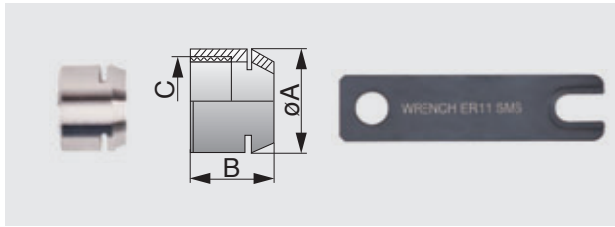

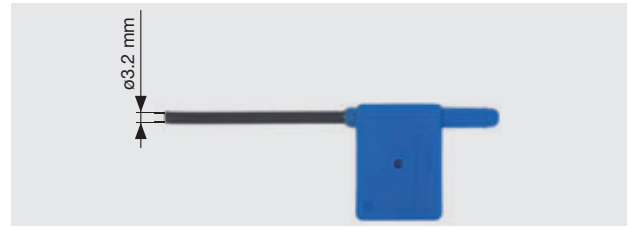

Metric	ϕA	B	C	Wrench
NUTER11GHS	16	11.5	M13X0.75	WRENCHER11SMS

Wrench for setting



Metric
WRENCHDIA3.2x45

Ring color	Blue	Red	Yellow
Shape			
No. of revolutions: n (min^{-1})	40,000	30,000	20,000
Designation	TJS40K...	TJS30K	TJS20K
Coolant pressure: (MPa)	2	2	2
Min. flow rate: (l/min)	12	12	12
Max. shank dia: ϕD_s (mm)	6	6	6
Tool dia: ϕD_c (mm)	0.2 - 1.5	1.6 - 2.5	2.6 - 3.5

Speed vs. pressure

Jet spindle type n (min^{-1})	Coolant pressure		
	2 MPa	3 MPa	4 MPa
TJS20K-ER32	20000	30000	40000
TJS30K-ER32	30000	40000	50000
TJS40K-ER32	40000	50000	60000

These are approximate RPM values, and they depend on coolant pressure, flow rate, and type.

MEMO

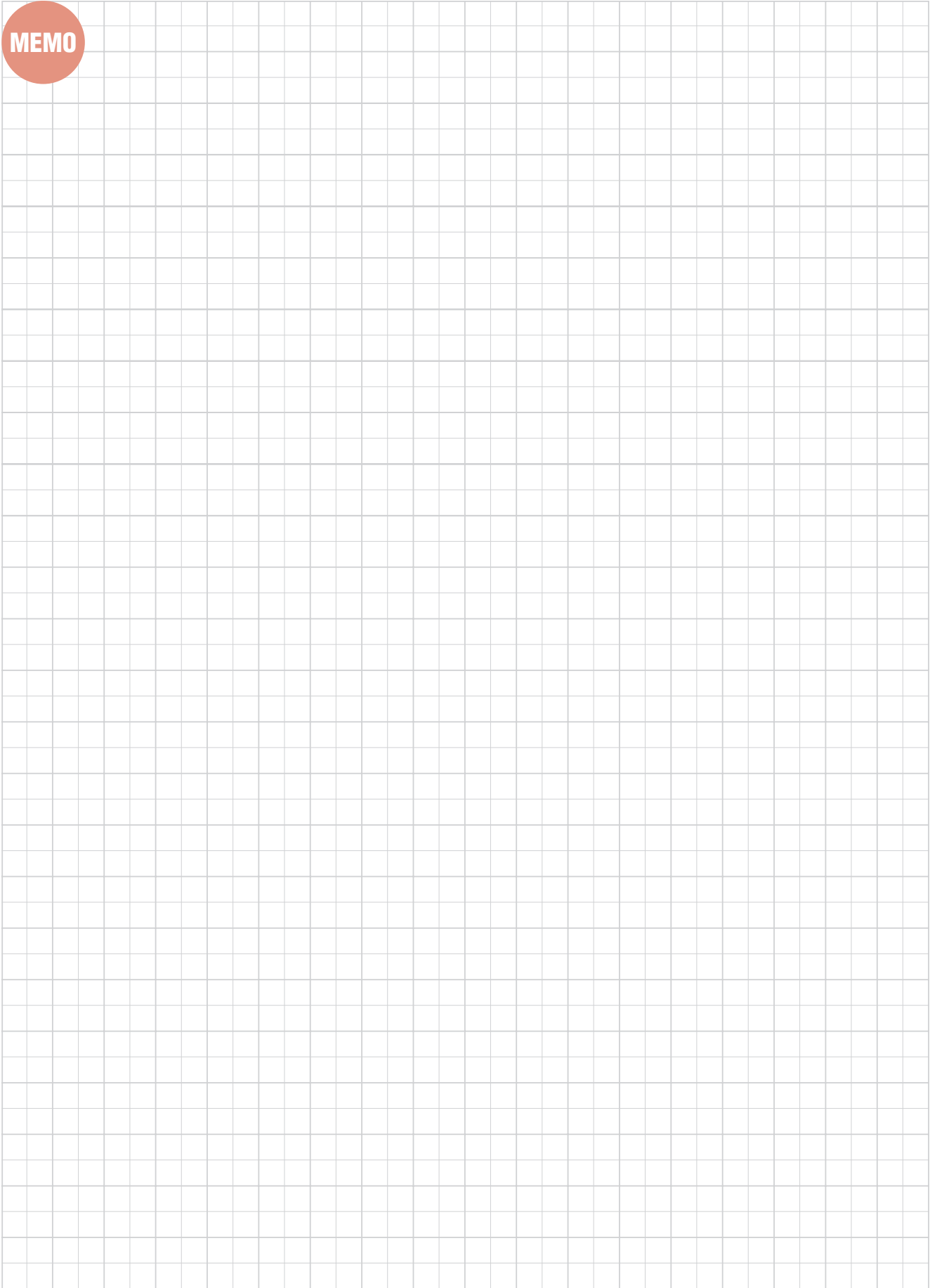

Tooling System

SPINJET

TUNGHOLD

HSK E-ER (Collet chuck holder)

ER collet chucks with HSK-E shank

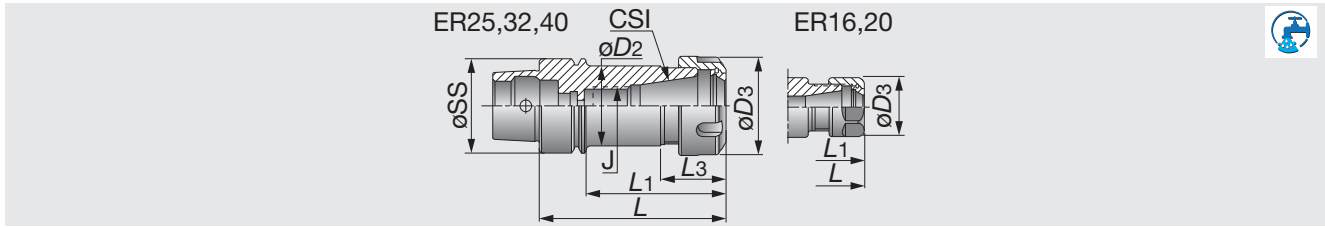

Metric	ϕSS	CSI	Range	L	L1	L3	ϕD_3	ϕD_2	J
HSKE32ER16X60	32	ER16	0.5-10	60	40	21.5	28	22.4	-
HSKE32ER20X60	32	ER20	1-13	6	40	26	34	25.4	-
HSKE32ER25X65	32	ER25	1-16	65	45	30	42	25.8	-
HSKE40ER16X60	40	ER16	0.5-10	60	40	-	28	-	-
HSKE40ER16X80	40	ER16	0.5-10	80	60	-	28	-	M10
HSKE40ER20X80	40	ER20	1-13	80	60	-	34	-	M12
HSKE40ER25X80	40	ER25	1-16	80	60	28	42	34	M18X1.5
HSKE40ER32X80	40	ER32	2-20	80	60	31	50	40.1	M22X1.5
HSKE50ER16X100 ⁽¹⁾	50	ER16	0.5-10	100	74	-	28	-	M10
HSKE50ER16X100M ⁽¹⁾⁽³⁾	50	ER16	0.5-10	100	74	-	22	-	M10
HSKE50ER16X80 ⁽¹⁾	50	ER16	0.5-10	80	54	-	28	-	M10
HSKE50ER20X80 ⁽¹⁾	50	ER20	1-13	80	54	-	34	-	M10
HSKE50ER25X80 ⁽¹⁾	50	ER25	1-16	80	54	28	42	32.4	-
HSKE50ER32X80 ⁽¹⁾	50	ER32	2-20	80	54	31	50	40.4	-
HSKE50ER32X100 ⁽¹⁾	50	ER32	2-20	100	74	31	50	40.4	M22X1.5
HSKE63ER16X80 ⁽²⁾	63	ER16	0.5-10	80	54	-	28	-	M10
HSKE63ER16X100 ⁽²⁾	63	ER16	0.5-10	100	74	-	28	-	M10
HSKE63ER20X75 ⁽²⁾	63	ER20	1-13	75	49	-	34	-	-
HSKE63ER32X80 ⁽²⁾	63	ER32	2-20	80	54	31	50	40.4	-
HSKE63ER32X100 ⁽²⁾	63	ER32	2-20	100	75	-	50	-	M22X1.5
HSKE63ER40X80 ⁽²⁾	63	ER40	3-26	80	54	34	63	-	-

(1) Balanced to G2.5 35,000 min⁻¹. (2) Balanced to G2.5 35,000 min⁻¹. (3) Balanced to G2.5 30,000 min⁻¹.
 • Equipped with nut ER 16 MINI.
 • Applicable for 10 MPa pressure coolant.

(Option:Wrench for ER collet)

Reference pages

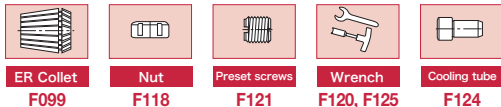

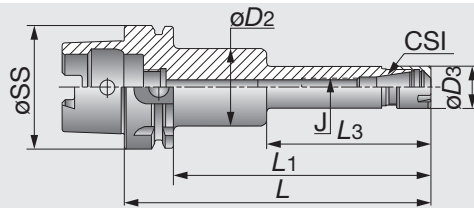

Metric	ϕSS	CSI	Range	L	L1	L3	$\phi D3$	$\phi D2$	J
HSKA50ER16X100M	50	ER16	0.5-10	100	74	-	22	-	M10
HSKA50ER16X120M	50	ER16	0.5-10	120	94	-	22	-	M10
HSKA50ER20X100M	50	ER20	1-13	100	74	-	28	-	M12
HSKA50ER20X120M	50	ER20	1-13	120	94	-	28	-	M12
HSKA63ER16X100M	63	ER16	0.5-10	100	74	-	22	-	M10
HSKA63ER16X120M	63	ER16	0.5-10	120	94	78	22	40	M10
HSKA63ER16X160M	63	ER16	0.5-10	160	134	85	22	40	M10
HSKA63ER20X100M	63	ER20	1-13	100	74	-	28	-	M12
HSKA63ER20X120M	63	ER20	1-13	120	94	-	28	-	M12
HSKA63ER20X160M	63	ER20	1-13	160	134	85	28	45	M12
HSKA100ER16X100M ⁽¹⁾	100	ER16	0.5-10	100	71	-	22	-	M10
HSKA100ER16X160M ⁽¹⁾	100	ER16	0.5-10	160	131	85	22	40	M10
HSKA100ER20X100M ⁽¹⁾	100	ER20	1-13	100	71	-	28	-	M12
HSKA100ER20X160M ⁽¹⁾	100	ER20	1-13	160	131	85	28	45	M12

(1) Balance to G6.3 12,000 min⁻¹.
 • Applicable for 10 MPa pressure coolant.

(Option: Wrench for ER collet)

Reference pages



ER Collet
F099



Nut
F118



Preset screws
F121



Wrench
F120, F125



Cooling tube
F124

TUNGHOLD

HSK A-ER (Collet chuck holder)

ER collet chucks with HSK-A shank

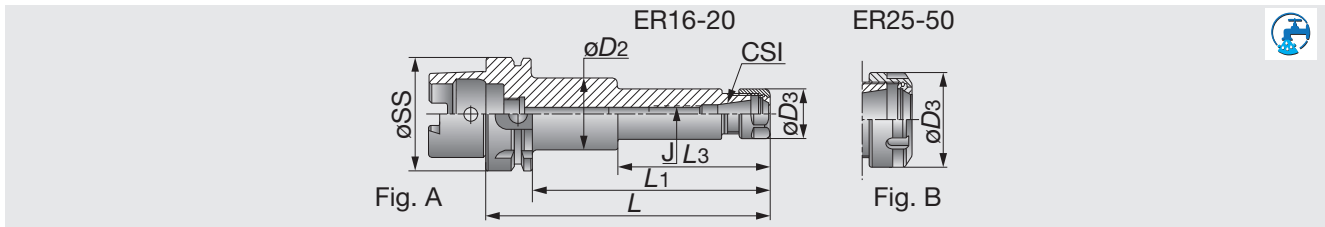

Metric	ϕSS	CSI	Range	L	L1	L3	$\phi D3$	$\phi D2$	J	Fig.
HSKA40ER16X60	40	ER16	0.5-10	60	40	-	28	-	M10	A
HSKA40ER16X80	40	ER16	0.5-10	80	60	-	28	-	M10	A
HSKA40ER16X100	40	ER16	0.5-10	100	80	-	28	-	M10	A
HSKA50ER16X100	50	ER16	0.5-10	100	74	-	28	-	M10	A
HSKA50ER16X120	50	ER16	0.5-10	120	94	-	28	-	M10	A
HSKA50ER20X100	50	ER20	1-13	100	74	-	34	-	M12	A
HSKA50ER20X120	50	ER20	1-13	120	94	-	34	-	M12	A
HSKA63ER16X100	63	ER16	0.5-10	100	74	-	28	-	M10	A
HSKA63ER16X120	63	ER16	0.5-10	120	94	-	28	-	M10	A
HSKA63ER16X160	63	ER16	0.5-10	160	134	85.6	28	40	M10	A
HSKA63ER20X100	63	ER20	1-13	100	74	-	34	-	M12	A
HSKA63ER20X120	63	ER20	1-13	120	94	-	34	-	M12	A
HSKA63ER20X160	63	ER20	1-13	160	134	85.0	34	45	M12	A
HSKA100ER16X100 ⁽¹⁾	100	ER16	0.5-10	100	71	-	28	-	M10	A
HSKA100ER16X160 ⁽¹⁾	100	ER16	0.5-10	160	131	85	28	40	M10	A
HSKA100ER20X100 ⁽¹⁾	100	ER20	1-13	100	71	-	34	-	M12	A
HSKA100ER20X160 ⁽¹⁾	100	ER20	1-13	160	131	85	34	45	M12	A
HSKA40ER25X80	40	ER25	1-16	80	60	28	42	32.4	M18x1.5	B
HSKA40ER25X100	40	ER25	1-16	100	80	28	42	32.4	M16	B
HSKA40ER32X100	40	ER32	2-20	100	80	31	50	40.4	M22x1.5	B
HSKA50ER25X80	50	ER25	1-16	80	54	28	42	32.4	M16	B
HSKA50ER25X100	50	ER25	1-16	100	74	28.5	42	41.8	M16	B
HSKA50ER32X100	50	ER32	2-20	100	74	31	50	40.4	M22x1.5	B
HSKA50ER32X120	50	ER32	2-20	120	94	35	50	41.8	M22x1.5	B
HSKA63ER25X80	63	ER25	1-16	80	54	-	42	-	M16	B
HSKA63ER25X100	63	ER25	1-16	100	74	-	42	-	M16	B
HSKA63ER25X120	63	ER25	1-16	120	94	-	42	-	M16	B
HSKA63ER25X160	63	ER25	1-16	160	134	-	42	-	M16	B
HSKA63ER32X80	63	ER32	2-20	80	54	31	50	40.4	M22x1.5	B
HSKA63ER32X100	63	ER32	2-20	100	74	-	50	-	M22x1.5	B
HSKA63ER32X120	63	ER32	2-20	120	94	-	50	-	M22x1.5	B
HSKA63ER32X140	63	ER32	2-20	140	114	-	50	-	M22x1.5	B
HSKA63ER32X160	63	ER32	2-20	160	134	-	50	-	M22x1.5	B
HSKA63ER40X80	63	ER40	3-26	80	54	34	63	50.4	-	B
HSKA63ER40X100	63	ER40	3-26	100	74	34	63	50.4	M28x1.5	B
HSKA63ER40X120	63	ER40	3-26	120	94	34	63	50.4	M28x1.5	B
HSKA100ER25X100	100	ER25	1-16	100	71	-	42	-	M16	B
HSKA100ER25X120	100	ER25	1-16	120	91	-	42	-	M16	B
HSKA100ER25X160	100	ER25	1-16	160	134	-	42	-	M16	B
HSKA100ER32X100	100	ER32	2-20	100	71	-	50	-	M22x1.5	B
HSKA100ER32X120	100	ER32	2-20	120	91	-	50	-	M22x1.5	B
HSKA100ER32X160	100	ER32	2-20	160	131	-	50	-	M22x1.5	B
HSKA100ER40X100	100	ER40	3-26	100	71	-	63	-	M28x1.5	B
HSKA100ER40X120	100	ER40	3-26	120	91	-	63	-	M28x1.5	B
HSKA100ER40X160	100	ER40	3-26	160	131	-	63	-	M28x1.5	B
HSKA100ER50X100	100	ER50	10-34	100	71	-	78	-	-	B

(1) Balanced to G6.3 12,000 min⁻¹.
 • Applicable for 10 MPa pressure coolant.

(Option: Wrench for ER collet)

Reference pages



TUNG HOLD

HSK FM-ER (Collet chuck holder)

ER collet chucks with HSK-FM shank



Tooling System

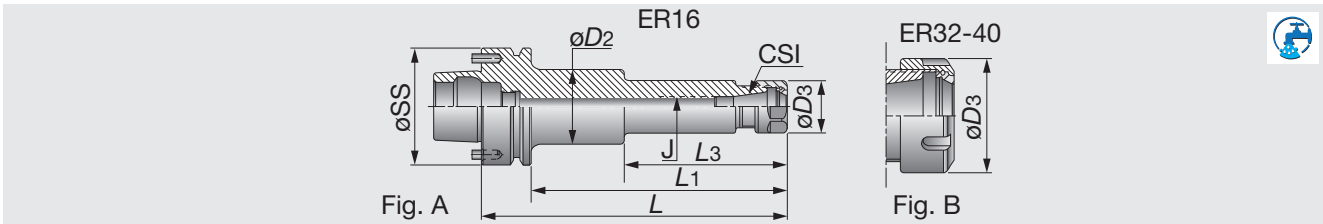

Metric	$\varnothing SS$	CSI	Range	L	L1	L3	$\varnothing D3$	$\varnothing D2$	J	Fig.
HSKFM63ER16X80	63	ER16	0.5-10	80	54	-	28	-	M10	A
HSKFM63ER16X100	63	ER16	0.5-10	100	74	-	28	-	M10	A
HSKFM63ER16X120	63	ER16	0.5-10	120	94	-	28	-	M10	A
HSKFM63ER16X160	63	ER16	0.5-10	160	134	85.6	28	40	M10	A
HSKFM63ER32X80	63	ER32	2-20	80	54	-	50	-	-	B
HSKFM63ER32X100	63	ER32	2-20	100	74	-	50	-	M22x1.5	B
HSKFM63ER40X80	63	ER40	3-26	80	54	32	63	50	-	B
HSKFM63ER40X100	63	ER40	3-26	100	74	32	63	50	M28x1.5	B

- The driving pins can be removed, turning the toolholder into a standard HSK "F63" type.
- Applicable for 10 MPa pressure coolant.

(Option: Wrench for ER collet)

TUNGBALANCE

HSK E-ER BIN (Collet chuck holder)

TungBalance adjustable dynamic balance collet chuck holder with HSK-E shank

TUNG HOLD

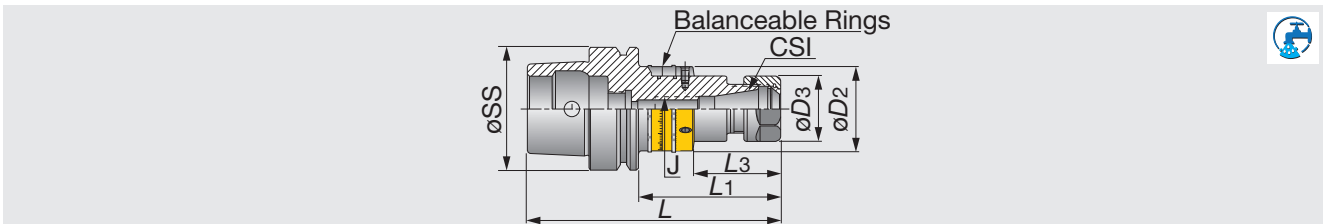

Metric	$\varnothing SS$	CSI	Range	L	L1	L3	$\varnothing D3$	$\varnothing D2$	J
HSKE63ER16X100BIN	63	ER16	0.5-10	100	74	45	28	44	M10
HSKE63ER20X100BIN	63	ER20	1-13	100	74	45.1	34	44	M12
HSKE63ER25X100BIN	63	ER25	1-16	100	74	45.2	42	44	M16
HSKE63ER32X120BIN	63	ER32	2-20	120	94	48	50	60	M22x1.5

- Balanced to G2.5 20,000 min⁻¹.
- Applicable for 10 MPa pressure coolant.

(Option: Wrench for ER collet)

Reference pages



ER Collet
F099



Nut
F118



Preset screws
F121



Wrench
F120, F125



Cooling tube
F124

TUNGBALANCE

HSK A-ER BIN (Collet chuck holder)

TungBalance adjustable dynamic balance collet chuck holder with HSK-A shank

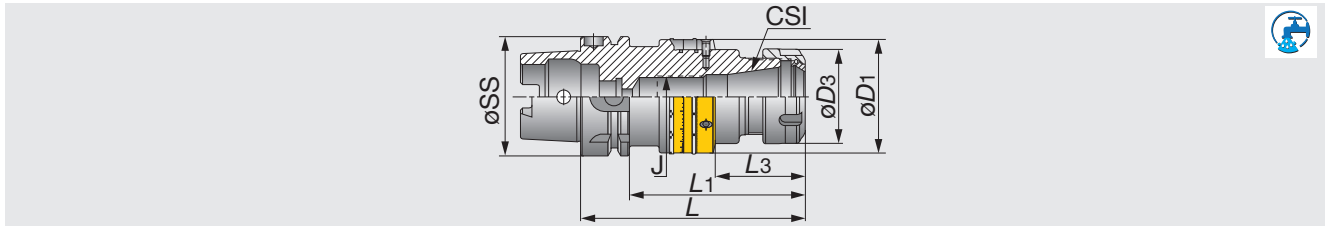

Metric	ϕSS	CSI	Range	L	L ₁	L ₃	ϕD_3	ϕD_1	J
HSKA63ER16X100BIN	63	ER16	0.5-10	100	74	45	28	44	M10
HSKA63ER16X160BIN	63	ER16	0.5-10	160	134	75	28	44	M10
HSKA63ER20X100BIN	63	ER20	1-13	100	74	45.1	34	44	M12
HSKA63ER20X160BIN	63	ER20	1-13	160	134	86.1	34	44	M12
HSKA63ER25X100BIN	63	ER25	1-16	100	74	45.2	42	44	M16
HSKA63ER25X160BIN	63	ER25	1-16	160	134	86.2	42	44	M16
HSKA63ER32X120BIN	63	ER32	2-20	120	94	48	50	60	M22x1.5
HSKA63ER32X160BIN	63	ER32	2-20	160	134	85	50	60	M22x1.5

- Balanced to G2.5 20,000 min⁻¹.
- Applicable for 10 MPa pressure coolant.

(Option:Wrench for ER collet)

TUNGSHORT

HSK A-SHORT (Collet chuck holder for short overhang)

TungShort collet chucks with HSK-A shank

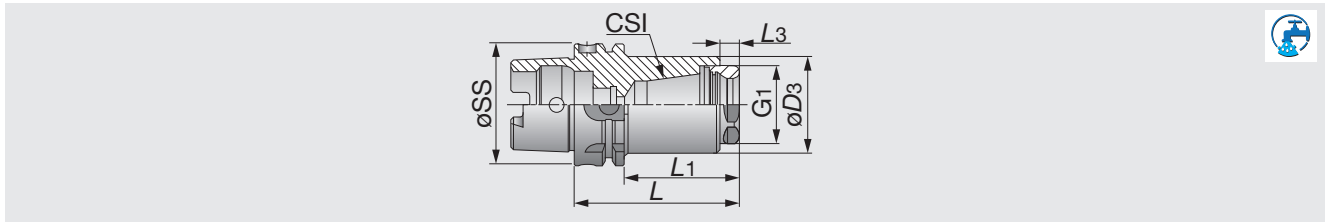

Metric	ϕSS	CSI	Range	L	L ₁	L ₃	ϕD_3	G1
HSKA63ER32SHORT	63	ER32	2-20	84.5	56.1	9.5	50	M40x1.5
HSKA100ER32SHORT	100	ER32	2-20	89.5	60.5	9.5	50	M40x1.5
HSKA100ER40SHORT	100	ER40	3-26	104.5	75.5	9.5	70	M50x1.5

- Balanced to G6.3 8,000 min⁻¹.
- Applicable for 10 MPa pressure coolant.

(Option:Wrench for ER collet)

Reference pages



TUNGMAX

HSK A-TUNGMAX (Power chuck holder)

TungMax endmill chuck holders with HSK-A shank



Tooling System

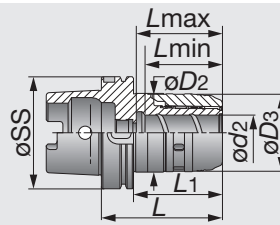

Metric	øSS	ød2	Range	L	L1	Lmin	Lmax	øD3	øD2
HSKA63MAXIN20X95	63	20	6-20	95	69	56	66	51	53
HSKA63MAXIN32X113	63	32	6-32	113	87	70	85	69	70
HSKA100MAXIN20X115 ⁽¹⁾	100	20	6-20	115	86	56	69	51	53
HSKA100MAXIN32X135 ⁽¹⁾	100	32	6-32	135	106	71	87	69	70

(1) Balanced to G6.3 8,000 min⁻¹.
 • Applicable for 10 MPa pressure coolant.

(Option:Wrench for TungMax collet)

TUNGBALANCE

HSK A-TUNGMAX BIN (Power chuck holder)

TungMax adjustable dynamic balanceable endmill chuck holders with HSK-A shank

TUNGHOLD

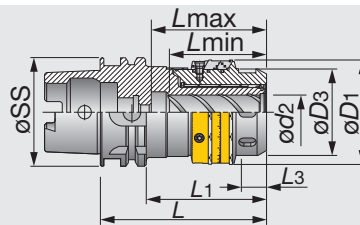

Metric	øSS	ød2	Range	L	L1	L3	Lmin	Lmax	øD3	øD1
HSKA63MAXIN20X95BIN ⁽¹⁾	63	20	6-20	95	69	17.5	56	66	51	61
HSKA63MAXIN32X113BIN ⁽¹⁾	63	32	6-32	113	87	24.9	70	85	69	80
HSKA100MAXIN20X115BIN ⁽²⁾	100	20	6-20	115	86	17.5	56	69	51	61
HSKA100MAXIN32X110BIN ⁽²⁾	100	32	6-32	110	81	24.9	70	78	69	80

(1) Chucks with taper size HSK A63 can be balanced by the balancing ring up to G2.5 at 20,000 min⁻¹.
 (2) Chucks with taper size HSK A100 can be balanced by the balancing ring up to G2.5 at 18,000 min⁻¹.
 • Applicable for 10 MPa pressure coolant.

(Option:Wrench for TungMax collet)

Reference pages



Straight collet

F108



Preset screws

F121



Wrench

F120, F125



Cooling tube

F124



TUNGHYDRO

HSK A-HYDRO (Hydro chuck holder)

TungHydro hydraulic endmill chuck holders with HSK-A shank

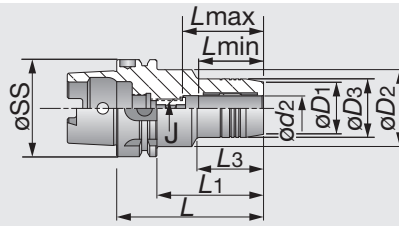

Metric	øSS	ød2	øD3	øD1	øD2	L	L1	L3	Lmin	Lmax	J
HSKA50HYDRO6X80	50	6	26	23	42	80	54	35	27	37	M5
HSKA50HYDRO8X80	50	8	28	25	42	80	54	36	27	37	M6
HSKA50HYDRO16X95	50	16	38	34	42	95	69	52	42	52	M12x1
HSKA50HYDRO20X100	50	20	42	38	42	100	74	74	42	52	M16x1
HSKA63HYDRO6X80	63	6	26	23	50	80	54	33	27	37	M5
HSKA63HYDRO8X80	63	8	28	25	50	80	54	33	27	37	M6
HSKA63HYDRO10X85	63	10	30	27	50	85	59	39	32	42	M8x1
HSKA63HYDRO12X90	63	12	32	29	50	90	64	44	37	47	M10x1
HSKA63HYDRO14X90	63	14	34	30	50	90	64	46	37	47	M10x1
HSKA63HYDRO16X95	63	16	38	34	50	95	69	52	42	52	M12x1
HSKA63HYDRO18X95	63	18	40	36	50	95	69	52	42	52	M12x1
HSKA63HYDRO20X100	63	20	42	38	50	100	74	58	42	52	M16x1
HSKA63HYDRO25X120	63	25	50	46	50	120	94	94	48	58	M16x1
HSKA63HYDRO32X125	63	32	60	56	50	125	99	83	52	62	M16x1
HSKA80HYDRO6X85	80	6	26	23	50	85	59	37	27	37	M5
HSKA80HYDRO10X90	80	10	30	27	50	90	64	42	32	42	M8x1
HSKA80HYDRO14X95	80	14	34	30	50	95	69	47	37	47	M10x1
HSKA80HYDRO16X100	80	16	38	34	50	100	74	52	42	52	M12x1
HSKA80HYDRO18X100	80	18	40	36	50	100	74	52	42	52	M12x1
HSKA80HYDRO20X105	80	20	42	38	50	105	79	52	42	52	M16x1
HSKA80HYDRO25X115	80	25	50	46	50	115	89	58	48	58	M16x1
HSKA100HYDRO6X85	100	6	26	23	63	85	56	29	27	37	M5
HSKA100HYDRO8X85	100	8	28	25	63	85	56	29	27	37	M6
HSKA100HYDRO10X90	100	10	30	27	63	90	61	35	32	42	M8x1
HSKA100HYDRO12X95	100	12	32	29	63	95	66	40	37	47	M10x1
HSKA100HYDRO14X95	100	14	34	30	63	95	66	42	37	47	M10x1
HSKA100HYDRO16X100	100	16	38	34	63	100	71	47	42	52	M12x1
HSKA100HYDRO18X100	100	18	40	36	63	100	71	48	42	52	M12x1
HSKA100HYDRO20X105	100	20	42	38	63	105	76	54	42	52	M16x1
HSKA100HYDRO25X115	100	25	50	46	63	115	86	51	48	58	M16x1
HSKA100HYDRO32X120	100	32	60	56	63	120	91	59	52	62	M16x1

- Note: Reduction sleeves are available for 12, 20, 25 and 32 mm bore diameters.
- Chucking forces will significantly reduce if reduction sleeves are used (ordered separately).
- Applicable for 7 MPa pressure coolant.

(Option:Wrench for TungHydro collet)

Reference pages



Straight collet

F111



Cooling tube

F124



Wrench

F125

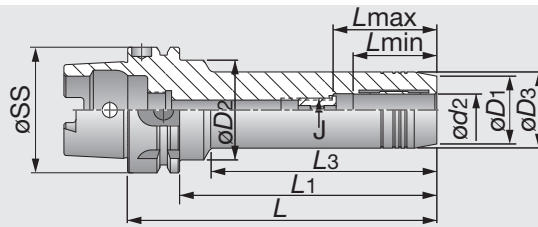

Metric	øSS	øD2	øD3	øD1	øD2	L	L1	L3	Lmin	Lmax	J
HSKA63HYDRO6X150	63	6	26	23	50	150	124	103	27	37	M5
HSKA63HYDRO6X200	63	6	26	23	50	200	174	153	27	37	M5
HSKA63HYDRO8X150	63	8	28	25	50	150	124	104	27	37	M6
HSKA63HYDRO10X150	63	10	30	27	50	150	124	104	32	42	M8x1
HSKA63HYDRO10X200	63	10	30	27	50	200	174	154	32	42	M8x1
HSKA63HYDRO12X150	63	12	32	29	50	150	124	105	37	47	M10x1
HSKA63HYDRO12X200	63	12	32	29	50	200	174	155	37	47	M10x1
HSKA63HYDRO14X150	63	14	34	30	50	150	124	105	37	47	M10x1
HSKA63HYDRO16X150	63	16	38	34	50	150	124	106.5	42	52	M12x1
HSKA63HYDRO16X200	63	16	38	34	50	200	174	156.5	42	52	M12x1
HSKA63HYDRO20X150	63	20	42	38	50	150	124	108	42	52	M12x1
HSKA63HYDRO20X200	63	20	42	38	50	200	174	158	42	52	M12x1
HSKA63HYDRO25X150	63	25	50	46	50	150	124	-	48	58	M16x1
HSKA63HYDRO25X200	63	25	50	46	50	200	174	-	48	58	M16x1
HSKA100HYDRO6X150	100	6	26	23	50	150	124	94	27	37	M6
HSKA100HYDRO6X200	100	6	26	23	50	200	174	144	27	37	M6
HSKA100HYDRO8X150	100	8	28	25	50	150	124	94.5	27	37	M6
HSKA100HYDRO8X200	100	8	28	25	50	200	174	144.5	27	37	M6
HSKA100HYDRO10X150	100	10	30	27	50	150	124	95	32	42	M8x1
HSKA100HYDRO10X200	100	10	30	27	50	200	174	145	32	42	M8x1
HSKA100HYDRO12X150	100	12	32	29	50	150	124	95.5	37	47	M10x1
HSKA100HYDRO12X200	100	12	32	29	50	200	174	145.5	37	47	M10x1
HSKA100HYDRO14X150	100	14	34	30	50	150	124	97	37	47	M10x1
HSKA100HYDRO14X200	100	14	34	30	50	200	174	147	37	47	M10x1
HSKA100HYDRO16X150	100	16	38	34	50	150	124	97.5	42	52	M12x1
HSKA100HYDRO16X200	100	16	38	34	50	200	174	147.5	42	52	M12x1
HSKA100HYDRO18X150	100	18	40	36	50	150	124	98	42	52	M12x1
HSKA100HYDRO18X200	100	18	40	36	50	200	174	148	42	52	M12x1
HSKA100HYDRO20X150	100	20	42	38	50	150	124	99	42	52	M12x1
HSKA100HYDRO20X200	100	20	42	38	50	200	174	149	42	52	M12x1
HSKA100HYDRO25X200	100	25	50	46	50	200	174	-	48	58	M16x1
HSKA100HYDRO32X200	100	32	60	56	60	200	174	-	52	62	M16x1

- Note: Reduction sleeves are available for 12, 20, 25 and 32 mm bore diameters.
- Chucking forces will significantly reduce if reduction sleeves are used (ordered separately).
- Applicable for 7 MPa pressure coolant.

(Option: Wrench for TungHydro collet)

Reference pages



Straight collet

F111



Cooling tube

F124



Wrench

F125



TUNGHOLD

HSK A-EM (Endmill holder)

Screw locking endmill holders with HSK-A shank

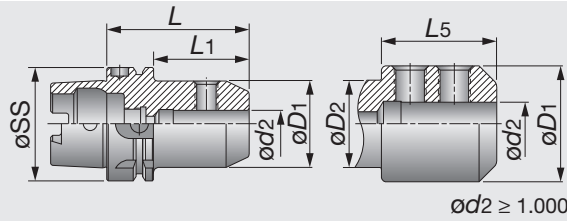

Inch	$\varnothing SS$	$\varnothing D2$	$\varnothing D1$	L	L1
HSK A 50 EM3/16 X2.562	50	0.188	0.866	2.562	1.538
HSK A 50 EM1/4 X2.562	50	0.250	1.000	2.562	1.380
HSK A 50 EM3/8 X2.562	50	0.375	1.380	2.562	1.530
HSK A 50 EM1/2 X3.125	50	0.500	1.610	3.125	2.100
HSK A 50 EM5/8 X3.125	50	0.625	1.752	3.125	2.101
HSK A 50 EM3/4 X3.125	50	0.750	1.937	3.125	2.101
HSK A 50 EM7/8 X4.000	50	0.875	2.205	4.000	2.976
HSK A 50 EM1" X4.250	50	1.000	2.563	4.250	3.226
HSK A 63 EM3/16 X2.562	63	0.188	0.870	2.562	1.530
HSK A 63 EM1/4 X2.562	63	0.250	1.000	2.562	1.530
HSK A 63 EM3/8 X2.562	63	0.375	1.380	2.562	1.530
HSK A 63 EM1/2 X3.125	63	0.500	1.610	3.125	2.100
HSK A 63 EM5/8 X3.125	63	0.625	1.750	3.125	2.100
HSK A 63 EM3/4 X3.150	63	0.750	1.940	3.150	2.100
HSK A 63 EM7/8 X4.000	63	0.875	2.050	4.000	2.970
HSK A 63 EM1 X4.250	63	1.000	2.560	4.250	3.220
HSK A 63 EM1-1/4X4.250	63	1.250	2.810	4.250	3.220
HSK A 100 EM3/16 X3.125	100	0.188	0.870	3.125	1.980
HSK A 100 EM1/4 X3.125	100	0.250	1.100	3.125	1.250
HSK A 100 EM3/8 X3.125	100	0.375	1.380	3.125	1.980
HSK A 100 EM1/2 X3.125	100	0.500	1.630	3.125	1.980
HSK A 100 EM5/8 X4.000	100	0.625	1.750	4.000	2.850
HSK A 100 EM3/4 X4.000	100	0.750	1.940	4.000	2.850
HSK A 100 EM7/8 X4.000	100	0.875	2.210	4.000	2.850
HSK A 100 EM1 X4.000	100	1.000	2.560	4.000	2.850
HSK A 100 EM1-1/4X4.000	100	1.250	2.810	4.000	2.850
HSK A 100 EM1-1/2X4.000	100	1.500	3.000	4.000	2.850

- A cooling tube must be used with all coolant through HSK spindles (should be ordered separately).
- Applicable for 7 MPa pressure coolant.

Reference pages



Lock Screw

F123



Wrench

F125



Cooling tube

F124

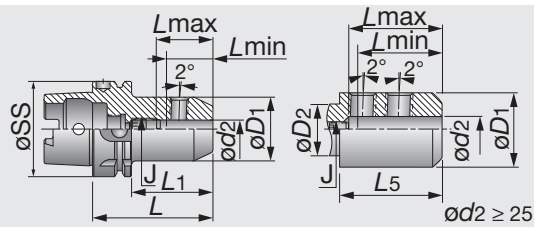

Metric	øSS	ød2	øD1	øD2	L	L1	L5	Lmin	Lmax	J	Key
HSKA50EM6X80E	50	6	25	-	80	54	-	30	38	M5	2.5
HSKA50EM8X80E	50	8	28	-	80	54	-	35	40	M6	3
HSKA50EM10X80E	50	10	35	-	80	54	-	39	44	M8	4
HSKA50EM12X90E	50	12	42	41.8	90	64	48	44	49	M10	5
HSKA50EM14X90E	50	14	44	41.8	90	64	48	44	49	M10	5
HSKA50EM16X90E	50	16	48	41.8	90	64	48	47	52	M12	6
HSKA50EM18X90E	50	18	50	41.8	90	64	48	47	52	M12	6
HSKA50EM20X100E	50	20	52	41.8	100	74	58	49	54	M16	8
HSKA63EM6X80E	63	6	25	-	80	54	-	32	40	M5	2
HSKA63EM8X80E	63	8	28	-	80	54	-	35	40	M6	3
HSKA63EM10X80E	63	10	35	-	80	54	-	39	44	M8	4
HSKA63EM12X90E	63	12	42	-	90	64	-	44	49	M10	5
HSKA63EM14X90E	63	14	44	-	90	64	-	44	49	M10	5
HSKA63EM16X100E	63	16	48	-	100	74	-	47	52	M12	6
HSKA63EM18X100E	63	18	50	-	100	74	-	47	55	M12	6
HSKA63EM20X100E	63	20	52	-	100	74	-	49	54	M16	8
HSKA63EM25X110E	63	25	65	52	110	84	65.5	54	61	M16	8
HSKA63EM32X110E	63	32	72	52	110	84	65.5	58	63	M20X1.5	10
HSKA100EM6X90E	100	6	25	-	90	61	-	35	40	M5	2.5
HSKA100EM8X90E	100	8	28	-	90	61	-	35	40	M6	3
HSKA100EM10X90E	100	10	35	-	90	61	-	39	44	M8	4
HSKA100EM12X100E	100	12	42	-	100	71	-	44	54	M10	5
HSKA100EM14X100E	100	14	44	-	100	71	-	44	54	M10	5
HSKA100EM16X100E	100	16	48	-	100	71	-	47	52	M12	6
HSKA100EM18X100E	100	18	50	-	100	71	-	47	52	M12	6
HSKA100EM20X110E	100	20	52	-	110	81	-	49	54	M16	8
HSKA100EM25X120E	100	25	65	-	120	91	-	54	61	M20X1.5	10
HSKA100EM32X120E	100	32	72	-	120	91	-	58	63	M20X1.5	10

(1) The adjustment screw has an internal coolant hole.
 • Applicable for 7 MPa pressure coolant.

Reference pages



Wrench
F125



Cooling tube
F124



TUNGSHRINK

HSK A-SRKIN (Shrink holder)

TungShrink thermal shrinking holder for carbide and HSS with HSK-A shank

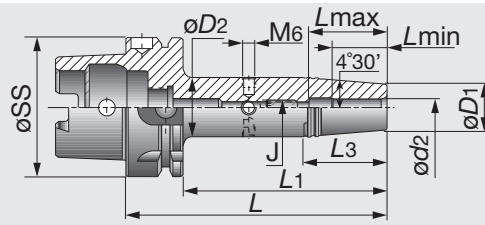

Inch	øSS	ød2	øD1	øD2	L	L1	L3	Lmin	Lmax	J	Key*
HSK A 63 SRKIN 1/4X3.150	63	0.250	0.827	1.060	3.150	2.126	1.500	0.980	1.420	M5	2.5
HSK A 63 SRKIN 1/4X 6.30	63	0.250	0.827	1.060	6.300	5.276	1.500	0.980	1.420	M5	2.5
HSK A 63 SRKIN5/16X3.150	63	0.313	0.827	1.060	3.150	2.217	1.500	0.980	1.420	M6	3
HSK A 63 SRKIN 5/16X6.30	63	0.313	0.827	1.060	6.300	5.276	1.500	0.980	1.420	M6	3
HSK A 63 SRKIN 3/8X3.346	63	0.375	0.940	1.260	3.346	2.320	2.000	1.220	1.650	M8	4
HSK A 63 SRKIN 3/8X6.30	63	0.375	0.940	1.260	6.300	5.276	2.000	1.220	1.650	M8	4
HSK A 63 SRKIN7/16X3.543	63	0.437	0.940	1.260	3.543	2.519	2.000	1.420	1.850	M10	5
HSK A 63 SRKIN 7/16X6.30	63	0.437	0.940	1.260	6.300	5.276	2.000	1.420	1.850	M10	5
HSK A 63 SRKIN 1/2X3.543	63	0.500	0.940	1.260	3.543	2.519	2.000	1.420	1.850	M10	5
HSK A 63 SRKIN 5/8X3.740	63	0.625	1.060	1.340	3.740	2.716	1.750	1.540	1.970	M12	6
HSK A 63 SRKIN 5/8X6.30	63	0.625	1.060	1.340	6.300	5.276	1.750	1.540	1.970	M12	6
HSK A 63 SRKIN 3/4X3.937	63	0.750	1.300	1.650	3.937	2.913	2.250	1.610	2.050	M16	8
HSK A 63 SRKIN 3/4X6.30	63	0.750	1.300	1.650	6.300	5.276	2.250	1.610	2.050	M16	8
HSK A 63 SRKIN 7/8X3.937	63	0.875	1.730	2.074	3.937	2.913	2.170	1.610	2.050	M16	8
HSK A 63 SRKIN1 X4.528	63	1.000	1.730	2.074	4.528	3.504	2.170	1.850	2.280	M16	8
HSK A 63 SRKIN1-1/4X4.72	63	1.250	1.730	2.074	4.725	3.700	2.170	1.850	2.280	M16	8
HSK A 100 SRKIN 1/4X3.500	100	0.250	0.827	1.060	3.500	2.358	1.500	0.980	1.420	M5	2.5
HSK A 100 SRKIN 1/4X4.750	100	0.250	0.827	1.060	4.750	3.608	1.500	0.980	1.420	M5	2.5
HSK A 100 SRKIN 1/4X6.250	100	0.250	0.827	1.060	6.250	5.108	1.500	0.980	1.420	M5	2.5
HSK A 100 SRKIN5/16X3.500	100	0.313	0.827	1.060	3.500	2.358	1.500	0.980	1.420	M6	3
HSK A 100 SRKIN5/16X4.750	100	0.313	0.827	1.060	4.750	3.608	1.500	0.980	1.420	M6	3
HSK A 100 SRKIN5/16X6.250	100	0.313	0.827	1.060	6.250	5.108	1.500	0.980	1.420	M6	3
HSK A 100 SRKIN 3/8X3.625	100	0.375	0.940	1.260	3.625	2.483	2.000	1.220	1.650	M8	4
HSK A 100 SRKIN 3/8X4.750	100	0.375	0.940	1.260	4.750	3.608	2.000	1.220	1.650	M8	4
HSK A 100 SRKIN 3/8X6.250	100	0.375	0.940	1.260	6.250	5.108	2.000	1.220	1.650	M8	4
HSK A 100 SRKIN7/16X3.750	100	0.437	0.940	1.260	3.750	2.608	2.000	1.420	1.850	M10	5
HSK A 100 SRKIN7/16X6.250	100	0.437	0.940	1.260	6.250	5.108	2.000	1.420	1.850	M10	5
HSK A 100 SRKIN 1/2X3.750	100	0.500	0.940	1.260	3.750	2.608	2.000	1.420	1.850	M10	5
HSK A 100 SRKIN 1/2X5.000	100	0.500	0.940	1.260	5.000	3.858	2.000	1.420	1.850	M10	5
HSK A 100 SRKIN 1/2X6.250	100	0.500	0.940	1.260	6.250	5.108	2.000	1.420	1.850	M10	5
HSK A 100 SRKIN 5/8X4.000	100	0.625	1.060	1.340	4.000	2.858	1.750	1.540	1.970	M12	6
HSK A 100 SRKIN 5/8X5.000	100	0.625	1.060	1.340	5.000	3.858	1.750	1.540	1.970	M12	6
HSK A 100 SRKIN 5/8X6.250	100	0.625	1.060	1.340	6.250	5.108	1.750	1.540	1.970	M12	6
HSK A 100 SRKIN 3/4X4.125	100	0.750	1.300	1.654	4.125	3.102	2.250	1.610	2.050	M12	6
HSK A 100 SRKIN 3/4X6.250	100	0.750	1.300	1.650	6.250	5.108	2.250	1.610	2.050	M16	8
HSK A 100 SRKIN 7/8X4.125	100	0.875	1.730	2.090	4.125	2.983	2.250	1.610	2.050	M12	6
HSK A 100 SRKIN 7/8X6.250	100	0.875	1.730	2.090	6.250	5.108	2.250	1.610	2.050	M16	8
HSK A 100 SRKIN 1X4.500	100	1.000	1.730	2.090	4.500	3.358	2.250	1.850	2.280	M12	6
HSK A 100 SRKIN1-1/4X4.75	100	1.250	1.730	2.090	4.750	3.608	2.250	1.850	2.280	M12	6

* Hex key (metric size) for the rear stopper screw.

- A cooling tube must be used with all coolant through HSK spindles (should be ordered separately).
- Use only inductive heating device for SRKIN holders.
- For solid carbide, HSS and steel tools.
- Tungaloy cannot guarantee an unbalance value less than 1 gr x mm.
- Applicable for 10 MPa pressure coolant.

Reference pages



F116



F116



F123



F125



F124



Metric	øSS	ød2	øD1	øD2	L	L1	L3	Lmin	Lmax	J	Key*
HSKA63SRKIN6X80	63	6	21	27	80	54	38	25	36	M5	2.5
HSKA63SRKIN6X120	63	6	21	27	120	94	38	25	36	M5	2.5
HSKA63SRKIN6X160	63	6	21	27	160	134	38	25	36	M5	2.5
HSKA63SRKIN8X80	63	8	21	27	80	54	38	25	36	M6	3
HSKA63SRKIN8X120	63	8	21	27	120	94	38	25	36	M6	3
HSKA63SRKIN8X160	63	8	21	27	160	134	38	25	36	M6	3
HSKA63SRKIN10X85	63	10	24	32	85	59	51	31	42	M8	4
HSKA63SRKIN10X120	63	10	24	32	120	94	51	31	42	M8	4
HSKA63SRKIN10X160	63	10	24	32	160	134	51	31	42	M8	4
HSKA63SRKIN12X90	63	12	24	32	90	64	51	36	42	M8	4
HSKA63SRKIN12X120	63	12	24	32	120	94	51	36	47	M10	5
HSKA63SRKIN12X160	63	12	24	32	160	134	51	36	47	M10	5
HSKA63SRKIN14X90	63	14	27	34	90	64	45	36	47	M10	5
HSKA63SRKIN14X120	63	14	27	34	120	94	45	36	47	M10	5
HSKA63SRKIN14X160	63	14	27	34	160	134	45	36	47	M10	5
HSKA63SRKIN16X75	63	16	27	34	75	49	-	39	50	-	-
HSKA63SRKIN16X95	63	16	27	34	95	69	44	39	50	M12	6
HSKA63SRKIN16X120	63	16	27	34	120	94	44	39	50	M12	6
HSKA63SRKIN16X160	63	16	27	34	160	134	44	39	50	M12	6
HSKA63SRKIN18X95	63	18	33	42	95	69	57	39	50	M12	6
HSKA63SRKIN18X120	63	18	33	42	120	94	57	39	50	M12	6
HSKA63SRKIN18X160	63	18	33	42	160	134	57	39	50	M12	6
HSKA63SRKIN20X75	63	20	33	41	75	49	-	41	50	-	-
HSKA63SRKIN20X100	63	20	33	42	100	74	57	41	52	M16	8
HSKA63SRKIN20X120	63	20	33	42	120	94	57	41	52	M16	8
HSKA63SRKIN20X160	63	20	33	42	160	134	57	41	52	M16	8
HSKA63SRKIN25X85	63	25	44	53	85	59	-	47	58	-	-
HSKA63SRKIN25X115	63	25	44	53	115	89	55	47	58	M16	8
HSKA63SRKIN32X85	63	32	44	53	85	59	-	47	58	-	-
HSKA63SRKIN32X120	63	32	44	53	120	94	55	47	58	M16	8
HSKA100SRKIN6X85	100	6	21	27	85	56	38	25	36	M5	2.5
HSKA100SRKIN6X120	100	6	21	27	120	91	38	25	36	M5	2.5
HSKA100SRKIN6X160	100	6	21	27	160	131	38	25	36	M6	3
HSKA100SRKIN8X85	100	8	21	27	85	56	38	25	36	M6	3
HSKA100SRKIN8X120	100	8	21	27	120	91	38	25	36	M6	3
HSKA100SRKIN8X160	100	8	21	27	160	131	38	25	36	M6	3
HSKA100SRKIN10X90	100	10	24	32	90	61	51	31	42	M8	4
HSKA100SRKIN10X120	100	10	24	32	120	91	51	31	42	M8	4
HSKA100SRKIN10X160	100	10	24	32	160	131	51	31	42	M8	4
HSKA100SRKIN12X95	100	12	24	32	95	66	51	36	47	M10	5
HSKA100SRKIN12X120	100	12	24	32	120	91	51	36	47	M10	5
HSKA100SRKIN12X160	100	12	24	32	160	131	51	36	47	M10	5
HSKA100SRKIN14X95	100	14	27	34	95	66	45	36	47	M10	5
HSKA100SRKIN14X120	100	14	27	34	120	91	45	36	47	M10	5
HSKA100SRKIN14X160	100	14	27	34	160	131	45	36	47	M10	5
HSKA100SRKIN16X100	100	16	27	34	100	71	45	39	50	M12	6
HSKA100SRKIN16X120	100	16	27	34	120	91	45	39	50	M12	6
HSKA100SRKIN16X160	100	16	27	34	160	131	45	39	50	M12	6
HSKA100SRKIN18X100	100	18	33	42	100	71	57	39	50	M12	6
HSKA100SRKIN18X160	100	18	33	42	160	131	57	39	50	M12	6
HSKA100SRKIN20X105	100	20	33	42	105	76	57	41	52	M16	8
HSKA100SRKIN20X160	100	20	33	42	160	131	57	41	52	M16	8
HSKA100SRKIN25X115	100	25	44	53	115	86	57	47	58	M16	8
HSKA100SRKIN32X120	100	32	44	53	120	91	57	47	58	M16	8

* Hex key (metric size) for the rear stopper screw. • A cooling tube must be used with all coolant through HSK spindles (should be ordered separately). • Use only inductive heating device for SRKIN holders. • For solid carbide, HSS and steel tools. • Tungaloy cannot guarantee an unbalance value less than 1 gr x mm. • Applicable for 10 MPa pressure coolant.

Reference pages



F116



F116



F123



F125



F124



TUNGSHRINK

HSK FM-SRKIN (Shrink holder)

TungShrink thermal shrinking holder for carbide and HSS with HSK-FM shank

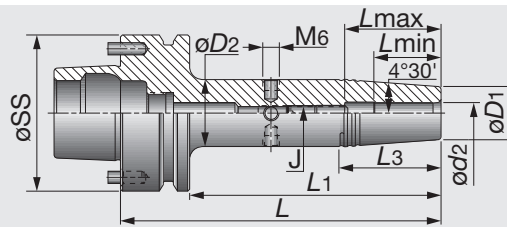

Inch	ϕSS	ϕd_2	ϕD_1	ϕD_2	L	L_1	L_3	L_{min}	L_{max}	J	Key*
HSK FM63 SRKIN 1/4X3.13	63	0.250	0.827	1.063	3.130	2.106	1.500	0.980	1.420	M5	2.5
HSK FM63 SRKIN 5/16X3.13	63	0.313	0.827	1.063	3.130	2.106	1.500	0.980	1.420	M6	3
HSK FM63 SRKIN 3/8X3.50	63	0.375	0.945	1.260	3.500	2.476	2.000	1.220	1.650	M8	4
HSK FM63 SRKIN 1/2X3.50	63	0.500	0.945	1.260	3.500	2.476	2.000	1.420	1.850	M8	4
HSK FM63 SRKIN 5/8X 3.50	63	0.625	1.063	1.339	3.500	2.476	1.752	1.540	1.970	M8	4
HSK FM63 SRKIN 3/4X3.00	63	0.750	1.299	1.610	3.000	2.976	-	1.610	2.050	-	-
HSK FM63 SRKIN 3/4X3.75	63	0.750	1.299	1.654	3.750	2.726	2.250	1.610	2.050	M12	6
HSK FM63 SRKIN 1X3.00	63	1.000	1.732	2.075	3.000	2.976	-	1.850	2.130	-	-
HSK FM63 SRKIN 1X4.00	63	1.000	1.732	2.075	4.000	2.976	2.252	1.850	2.280	M16	8
HSK FM80 SRKIN 1/4X3.25	80	0.250	0.827	1.063	3.250	2.226	1.500	0.960	1.420	M5	2.5
HSK FM80 SRKIN 3/8X3.25	80	0.375	0.945	1.260	3.250	2.226	2.000	1.200	1.650	M8	4
HSK FM80 SRKIN 1/2X3.25	80	0.500	0.945	1.260	3.250	2.226	2.000	1.400	1.850	M10	5
HSK FM80 SRKIN 5/8X3.25	80	0.625	1.063	1.340	3.250	2.266	1.752	1.510	1.970	M12	6
HSK FM80 SRKIN 3/4X3.25	80	0.750	1.300	1.654	3.250	2.266	2.252	1.600	2.050	M16	6
HSK FM80 SRKIN 1X3.50	80	1.000	1.732	2.075	3.500	2.476	2.252	1.830	2.280	M16	8
HSK FM80 SRKIN 1 1/4X3.50	80	1.250	1.732	2.075	3.500	2.476	2.252	1.980	2.440	M16	8

- * Hex key (metric size) for the rear stopper screw.
- A cooling tube must be used with all coolant through HSK spindles (should be ordered separately).
- For solid carbide, HSS and steel tools.
- Use only inductive heating device for SRKIN holders.
- The orientation pins can be removed, turning the toolholder into a standard HSK F 63 type.
- Applicable for 10 MPa pressure coolant.

Metric	ϕSS	ϕd_2	ϕD_1	ϕD_2	L	L_1	L_3	L_{min}	L_{max}	J	Key*
HSKFM63SRKIN6X80	63	6	21	27	80	54	38	25	36	M5	2.5
HSKFM63SRKIN8X80	63	8	21	27	80	54	38	25	36	M6	3
HSKFM63SRKIN10X85	63	10	24	32	85	59	50.5	31	42	M8	4
HSKFM63SRKIN12X90	63	12	24	32	90	64	50.5	36	47	M10	5
HSKFM63SRKIN14X90	63	14	27	34	90	64	44.5	36	47	M10	5
HSKFM63SRKIN16X95	63	16	27	34	95	69	44.5	39	50	M12	6
HSKFM63SRKIN18X95	63	18	33	42	95	69	57	39	50	M12	6
HSKFM63SRKIN20X100	63	20	33	42	100	74	57	41	52	M16	8
HSKFM63SRKIN25X115	63	25	44	52.7	115	89	55	47	58	M16	8
HSKFM63SRKIN32X120	63	32	44	52.7	120	94	55	47	58	M16	8

- * Hex key (metric size) for the rear stopper screw.
- A cooling tube must be used with all coolant through HSK spindles (should be ordered separately).
- For solid carbide, HSS and steel tools.
- Use only inductive heating device for SRKIN holders.
- The orientation pins can be removed, turning the toolholder into a standard HSK F 63 type.
- Applicable for 10 MPa pressure coolant.

Reference pages



Induction heating unit

F116



Heating unit

F116



Preset screws

F123



Wrench

F125



Cooling tube

F124

MEMO

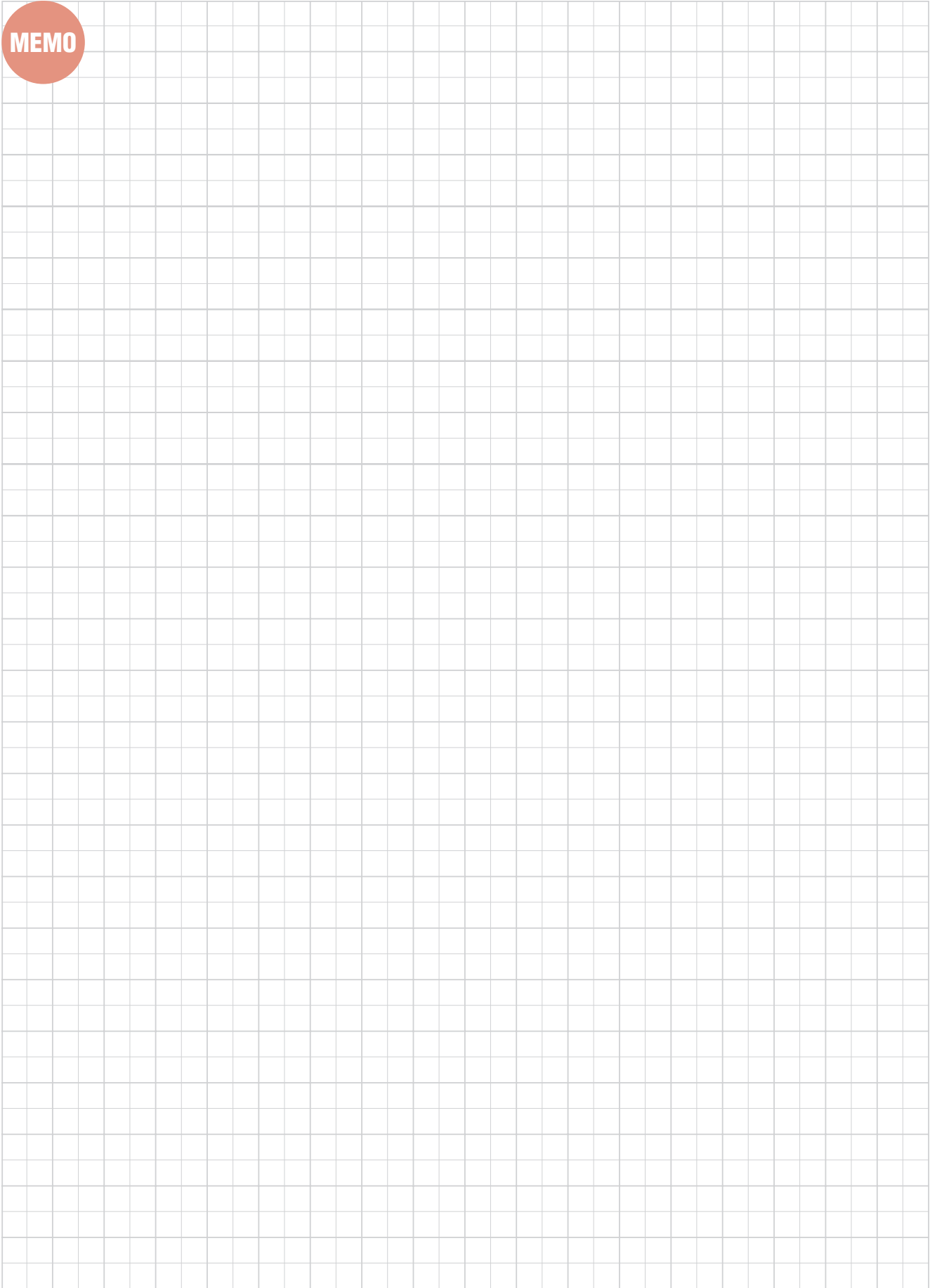

Tooling System

TUNGHOLD

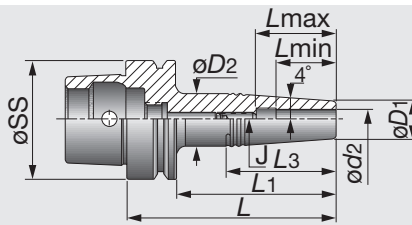

Inch	øSS	ød2	øD1	øD2	L	L1	L3	Lmin	Lmax	J	Key*
HSK E 32 SRK 1/8X2.000	32	0.125	0.394	0.591	2.787	2.000	1.407	0.390	0.790	M4	2
HSK E 32 SRK 3/16X2.000	32	0.187	0.394	0.591	2.787	2.000	1.407	0.590	0.980	M4	2
HSK E 32 SRK 1/4X2.000	32	0.250	0.433	0.630	2.787	2.000	1.406	0.710	1.100	M4	2
HSK E 32 SRK 5/16X2.000	32	0.312	0.551	0.787	2.787	2.000	1.406	0.980	1.380	M4	2
HSK E 32 SRK 3/8X2.000	32	0.375	0.630	0.866	2.787	2.000	1.677	1.180	1.580	M4	2
HSK E 32 SRK 1/2X2.000	32	0.500	0.787	0.984	2.787	2.000	1.392	1.260	1.580	M4	2
HSK E 40 SRK1/8 X1.750	40	0.125	0.390	0.590	2.537	1.750	1.400	0.390	0.630	M5	2.5
HSK E 40 SRK1/8 X3.000	40	0.125	0.390	0.748	3.787	3.000	2.526	0.390	0.630	M5	2.5
HSK E 40 SRK3/16X1.750	40	0.187	0.390	0.590	2.537	1.750	1.400	0.590	0.980	M4	2
HSK E 40 SRK3/16X3.000	40	0.187	0.390	0.748	3.787	3.000	2.526	0.590	0.980	M4	2
HSK E 40 SRK1/4 X1.750	40	0.250	0.430	0.630	2.537	1.750	1.400	0.710	1.100	M5	2.5
HSK E 40 SRK1/4 X3.000	40	0.250	0.430	0.787	3.787	3.000	2.524	0.710	1.100	M5	2.5
HSK E 40 SRK5/16X1.750	40	0.312	0.550	0.550	2.537	1.750	1.637	0.980	1.380	M5	2.5
HSK E 40 SRK5/16X3.000	40	0.312	0.550	0.905	3.787	3.000	2.518	0.980	1.380	M6	3
HSK E 40 SRK3/8 X1.750	40	0.375	0.630	0.866	2.537	1.750	1.670	1.180	1.580	M5	2.5
HSK E 40 SRK3/8 X3.000	40	0.375	0.630	0.965	3.787	3.000	2.373	1.180	1.580	M8	4
HSK E 40 SRK7/16X1.750	40	0.437	0.790	1.024	2.537	1.750	1.665	1.220	1.610	M5	2.5
HSK E 40 SRK7/16X3.000	40	0.437	0.790	1.102	3.787	3.000	2.229	1.220	1.610	M10	3
HSK E 40 SRK1/2 X1.750	40	0.500	0.790	1.024	2.537	1.750	1.665	1.260	1.650	M5	2.5
HSK E 40 SRK1/2 X3.000	40	0.500	0.790	1.102	3.787	3.000	2.229	1.260	1.650	M10	5
HSK E 50 SRK 1/8 X1.750	50	0.125	0.390	0.590	2.774	1.750	1.400	0.390	0.630	M5	2.5
HSK E 50 SRK 1/8 X3.000	50	0.125	0.390	0.748	4.024	3.000	2.526	0.390	0.630	M5	2.5
HSK E 50 SRK 3/16X1.750	50	0.187	0.390	0.590	2.774	1.750	1.400	0.590	0.830	M6	3
HSK E 50 SRK 3/16X3.000	50	0.187	0.390	0.748	4.024	3.000	2.526	0.590	0.830	M6	3
HSK E 50 SRK 1/4 X1.750	50	0.250	0.430	0.630	2.774	1.750	1.400	0.710	1.100	M5	2.5
HSK E 50 SRK 1/4 X3.000	50	0.250	0.430	0.787	4.024	3.000	2.524	0.710	1.100	M5	2.5
HSK E 50 SRK 5/16X1.750	50	0.312	0.550	0.787	2.774	1.750	1.673	0.980	1.380	M6	3
HSK E 50 SRK 5/16X3.000	50	0.312	0.550	0.905	4.024	3.000	2.518	0.980	1.380	M6	3
HSK E 50 SRK 3/8 X1.750	50	0.375	0.630	0.866	2.774	1.750	1.670	1.180	1.580	M6	3
HSK E 50 SRK 3/8 X3.000	50	0.375	0.630	0.965	4.024	3.000	2.373	1.180	1.580	M8	4
HSK E 50 SRK 7/16X1.750	50	0.437	0.790	1.024	2.774	1.750	1.665	1.220	1.610	M6	3
HSK E 50 SRK 7/16X3.000	50	0.437	0.790	1.102	4.024	3.000	2.229	1.220	1.610	M10	5
HSK E 50 SRK 1/2 X1.750	50	0.500	0.790	1.024	2.774	1.750	1.665	1.260	1.650	M6	3
HSK E 50 SRK 1/2 X3.000	50	0.500	0.790	1.102	4.024	3.000	2.229	1.260	1.650	M10	5
HSK E 63 SRK 1/8X2.000	63	0.125	0.390	0.669	3.024	2.000	1.927	0.390	0.630	M6	3
HSK E 63 SRK 1/8X3.000	63	0.125	0.390	0.748	4.024	3.000	2.526	0.390	0.630	M6	3
HSK E 63 SRK 3/16X2.000	63	0.187	0.390	0.669	3.024	2.000	1.927	0.590	0.830	M6	3
HSK E 63 SRK 3/16X3.000	63	0.187	0.390	0.748	4.024	3.000	2.526	0.590	0.830	M6	3
HSK E 63 SRK 1/4X2.000	63	0.250	0.430	0.709	3.024	2.000	1.927	0.710	0.950	M8	4
HSK E 63 SRK 1/4X3.000	63	0.250	0.430	0.787	4.024	3.000	2.524	0.710	0.950	M8	4
HSK E 63 SRK 5/16X2.000	63	0.312	0.550	0.827	3.024	2.000	1.927	0.980	1.380	M6	3
HSK E 63 SRK 5/16X3.000	63	0.312	0.550	0.905	4.024	3.000	2.518	0.980	1.380	M6	3
HSK E 63 SRK 3/8X2.000	63	0.375	0.630	0.906	3.024	2.000	1.927	1.180	1.580	M8	4
HSK E 63 SRK 3/8X3.000	63	0.375	0.630	1.000	4.024	3.000	2.373	1.180	1.580	M8	4
HSK E 63 SRK 7/16X2.000	63	0.437	0.790	1.063	3.024	2.000	1.927	1.220	1.610	M8	4
HSK E 63 SRK 7/16X3.000	63	0.437	0.790	1.102	4.024	3.000	2.229	1.220	1.610	M10	5
HSK E 63 SRK 1/2X2.000	63	0.500	0.790	1.063	3.024	2.000	1.927	1.260	1.650	M8	4
HSK E 63 SRK 1/2X3.000	63	0.500	0.790	1.102	4.024	3.000	2.229	1.260	1.650	M10	5

* Hex key (metric size) for the rear stopper screw.

• A cooling tube must be used with all coolant through HSK spindles (should be ordered separately). • Applicable for 10 MPa pressure coolant.

Reference pages



Induction heating unit

F116



Heating unit

F116



Preset screws

F123



Wrench

F125



Cooling tube

F124



Metric	øSS	ød2	øD1	øD2	L	L1	L3	Lmin	Lmax	J	Key*
HSKE32SRK3X45	32	3	10	13	65	45	30	10	16	M4	2
HSKE32SRK4X45	32	4	10	15	65	45	35	12	18	M4	2
HSKE32SRK5X45	32	5	10	15	65	45	35	15	25	M4	2
HSKE32SRK6X45	32	6	11	16	65	45	35	18	28	M4	2
HSKE32SRK8X45	32	8	14	20	65	45	42	25	35	M4	2
HSKE32SRK10X45	32	10	16	22	65	45	42	30	40	M4	2
HSKE32SRK12X45	32	12	20	25	65	45	35.6	32	40	M4	2
HSKE40SRK3X45	40	3	10	13	65	45	30	10	16	M5	2.5
HSKE40SRK3X80	40	3	10	19	100	80	64	10	16	M5	2.5
HSKE40SRK4X45	40	4	10	15	65	45	35	12	18	M5	2.5
HSKE40SRK4X80	40	4	10	19	100	80	64	12	18	M5	2.5
HSKE40SRK5X45	40	5	10	15	65	45	35	15	25	M4	2
HSKE40SRK5X80	40	5	10	19	100	80	64	15	25	M4	2
HSKE40SRK6X45	40	6	11	16	65	45	35	18	28	M5	2.5
HSKE40SRK6X80	40	6	11	20	100	80	64	18	28	M5	2.5
HSKE40SRK8X45	40	8	14	20	65	45	42	25	35	M5	2.5
HSKE40SRK8X80	40	8	14	23	100	80	64	25	35	M6	3
HSKE40SRK10X45	40	10	16	22	65	45	42	30	40	M5	2.5
HSKE40SRK10X80	40	10	16	24.5	100	80	60	30	40	M8	4
HSKE40SRK12X45	40	12	20	26	65	45	42	32	42	M5	2.5
HSKE40SRK12X80	40	12	20	28	100	80	56	32	42	M10	5
HSKE50SRK3X45 ⁽¹⁾	50	3	10	15	71	45	36	10	16	M5	2.5
HSKE50SRK3X80 ⁽¹⁾	50	3	10	19	106	80	64	10	16	M5	2.5
HSKE50SRK4X45 ⁽¹⁾	50	4	10	15	71	45	36	12	18	M5	2.5
HSKE50SRK4X80 ⁽¹⁾	50	4	10	19	106	80	64	12	18	M5	2.5
HSKE50SRK5X45 ⁽¹⁾	50	5	10	15	71	45	36	15	21	M6	3
HSKE50SRK5X80	50	5	10	19	106	80	64	15	21	M6	3
HSKE50SRK6X45 ⁽¹⁾	50	6	11	16	71	45	36	18	28	M5	2.5
HSKE50SRK6X80 ⁽¹⁾	50	6	11	20	106	80	64	18	28	M5	2.5
HSKE50SRK8X45 ⁽¹⁾	50	8	14	20	71	45	43	25	35	M6	3
HSKE50SRK8X80 ⁽¹⁾	50	8	14	23	106	80	64	25	35	M6	3
HSKE50SRK10X45 ⁽¹⁾	50	10	16	22	71	45	42	30	37	M6	3
HSKE50SRK10X80 ⁽¹⁾	50	10	16	24.5	106	80	60	30	40	M8	4
HSKE50SRK12X45 ⁽¹⁾	50	12	20	26	71	45	42	32	39	M6	3
HSKE50SRK12X80 ⁽¹⁾	50	12	20	28	106	80	57	32	42	M10	5
HSKE63SRK3X50	63	3	10	17	76	50	48	10	16	M6	3
HSKE63SRK3X80	63	3	10	19	106	80	64	10	16	M6	3
HSKE63SRK4X50	63	4	10	17	76	50	48	12	18	M6	3
HSKE63SRK4X80	63	4	10	19	106	80	64	12	18	M6	3
HSKE63SRK5X45	63	5	10	15	71	45	36	15	21	M6	3
HSKE63SRK5X80	63	5	10	19	106	80	64	15	21	M6	3
HSKE63SRK6X50	63	6	11	18	76	50	48	18	24	M8	4
HSKE63SRK6X80	63	6	11	20	106	80	64	18	24	M8	4
HSKE63SRK8X50	63	8	14	21	76	50	48	25	35	M6	3
HSKE63SRK8X80	63	8	14	23	106	80	64	25	35	M6	3
HSKE63SRK10X50	63	10	16	23	76	50	48	30	40	M8	4
HSKE63SRK10X80	63	10	16	24.5	106	80	60	30	40	M8	4
HSKE63SRK12X50	63	12	20	27	76	50	48	32	42	M8	4
HSKE63SRK12X80	63	12	20	28	106	80	57	32	42	M10	5
HSKE63SRK12X90	63	12	20	28	116	90	57	32	43	M10	5

(1) Balanced to G2.5 35,000 min⁻¹. * Hex key (metric size) for the rear stopper screw.

• A cooling tube must be used with all coolant through HSK spindles (should be ordered separately). • Applicable for 10 MPa pressure coolant.

Reference pages



Induction heating unit

F116



Heating unit

F116



Preset screws

F123



Wrench

F125



Cooling tube

F124

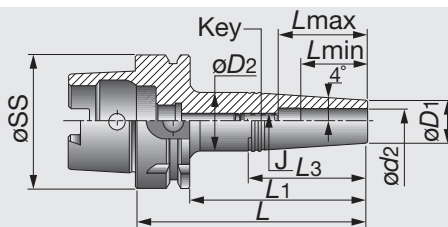

Inch	øSS	ød2	øD1	øD2	L	L1	L3	Lmin	Lmax	J	Key*
HSK A 63 SRK 1/8 X2.000	63	0.125	0.390	0.699	3.024	2.000	-	0.390	0.630	M6	3
HSK A 63 SRK 1/8 X3.250	63	0.125	0.390	0.823	4.274	3.250	3.098	0.390	0.630	M6	3
HSK A 63 SRK 3/16X2.000	63	0.187	0.390	0.699	3.024	2.000	-	0.590	0.830	M6	3
HSK A 63 SRK 3/16X3.250	63	0.187	0.390	0.823	4.274	3.250	3.098	0.590	0.830	M6	3
HSK A 63 SRK 1/4 X2.000	63	0.250	0.430	0.699	3.024	2.000	-	0.590	0.950	M8	4
HSK A 63 SRK 1/4 X3.250	63	0.250	0.430	0.866	4.274	3.250	3.098	0.710	0.950	M8	4
HSK A 63 SRK 5/16X2.000	63	0.312	0.550	0.831	3.024	2.000	-	0.980	1.420	M6	3
HSK A 63 SRK 5/16X3.250	63	0.312	0.550	0.906	4.274	3.250	3.098	0.980	1.420	M6	3
HSK A 63 SRK 3/8X2.000	63	0.375	0.630	0.787	3.024	2.000	1.693	1.180	1.610	M8	4
HSK A 63 SRK 3/8X3.250	63	0.375	0.630	1.024	4.274	3.250	2.535	1.180	1.610	M8	4
HSK A 63 SRK 7/16X2.000	63	0.437	0.790	1.067	3.024	2.000	-	1.220	1.650	M8	4
HSK A 63 SRK 7/16X3.250	63	0.437	0.790	1.181	4.274	3.250	2.815	1.220	1.650	M10	5
HSK A 63 SRK 1/2 X2.000	63	0.500	0.790	1.063	3.024	2.000	-	1.260	1.690	M8	4
HSK A 63 SRK 1/2 X3.250	63	0.500	0.790	1.181	4.274	3.250	2.815	1.260	1.690	M10	5

- * Hex key (metric size) for the rear stopper screw.
- A cooling tube must be used with all coolant through HSK spindles (should be ordered separately).
- Applicable for 10 MPa pressure coolant.

Metric	øSS	ød2	øD1	øD2	L	L1	L3	Lmin	Lmax	J	Key*
HSKA63SRK3X50	63	3	10	17	76	50	-	10	16	M6	3
HSKA63SRK3X85	63	3	10	21	111	85	79	10	16	M6	3
HSKA63SRK4X50	63	4	10	17	76	50	-	12	18	M6	3
HSKA63SRK4X85	63	4	10	21	111	85	79	12	18	M6	3
HSKA63SRK5X50	63	5	10	17	76	50	-	15	21	M6	3
HSKA63SRK5X85	63	5	10	21	111	85	79	15	21	M6	3
HSKA63SRK6X50	63	6	11	18	76	50	-	18	24	M8	4
HSKA63SRK6X85	63	6	11	22	111	85	79	18	24	M8	4
HSKA63SRK8X50	63	8	14	20	76	50	43	25	36	M6	3
HSKA63SRK8X85	63	8	14	23	111	85	64	25	36	M6	3
HSKA63SRK10X50	63	10	16	23	76	50	-	30	41	M8	4
HSKA63SRK10X85	63	10	16	26	111	85	72	30	41	M8	4
HSKA63SRK12X50	63	12	20	27	76	50	-	32	43	M8	4
HSKA63SRK12X85	63	12	20	30	111	85	72	32	43	M8	4

- * Hex key (metric size) for the rear stopper screw.
- A cooling tube must be used with all coolant through HSK spindles (should be ordered separately).
- Applicable for 10 MPa pressure coolant.

Reference pages

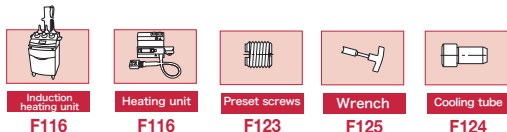

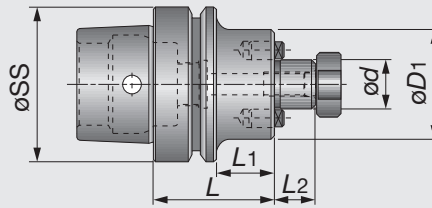

Inch	øSS	ød	L2	øD1	L	L1
HSK E 32 SEM 3/4X2	32	0.750	0.669	1.752	2.000	1.213
HSK E 40 SEM 3/4X2.000	40	0.750	0.669	1.771	2.000	1.213
HSK E 63 SEM 3/4X2.375	63	0.750	0.669	1.771	2.375	1.351
HSK E 63 SEM 1 X2.375	63	1.000	0.669	2.079	2.375	1.351

- A cooling tube must be used with all coolant through HSK spindles (should be ordered separately).
- Applicable for 7 MPa pressure coolant.

(Option:Wrench for lock screw)

Metric	øSS	ød	L2	øD1	L	L1
HSKE40SEM16X50	40	16	17	38	50	30
HSKE40SEM22X50	40	22	19	47	50	30
HSKE50SEM22X60	50	22	19	47	60	34
HSKE63SEM16X50	63	16	17	38	50	24
HSKE63SEM22X50	63	22	19	47	50	24
HSKE32SEM3/4X2	32	19.05	17	44.5	50.8	30.8
HSKE40SEM3/4X2.000	40	19.05	17	45	50.8	30.8
HSKE50SEM3/4X2.375	50	19.05	17	45	60.3	34.3
HSKE63SEM3/4X2.375	63	19.05	17	45	60.3	34.3
HSKE63SEM1X2.375	63	25.4	17	52.8	60.3	34.3

- A cooling tube must be used with all coolant through HSK spindles (should be ordered separately).
- Applicable for 7 MPa pressure coolant.

(Option:Wrench for lock screw)

Reference pages



Clamping screw

F122



Wrench

F124, F125



Cooling tube

F124



TUNGHOLD

HSK A-SEM (Shell mill holder)

Shell mill holder with HSK-A shank

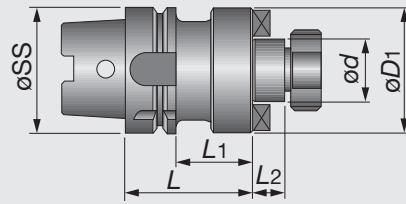

Inch	$\varnothing SS$	$\varnothing d$	$L2$	$\varnothing D1$	L	$L1$
HSK A 50 SEM3/4 X2.375	50	0.750	0.669	1.770	2.375	1.351
HSK A 50 SEM 1X2.500	50	1.000	0.669	2.172	2.500	2.172
HSK A 50 SEM1-1/4X3.000	50	1.250	0.669	2.516	3.000	2.516
HSK A 63 SEM3/4 X2.375	63	0.750	0.669	1.770	2.375	1.351
HSK A 63 SEM1X1.750	63	1.000	0.669	2.086	1.750	0.726
HSK A 63 SEM1 X4.000	63	1.000	0.669	2.086	4.000	2.984
HSK A 63 SEM3/4X5.000*	63	0.750	0.669	1.772	5.000	3.984
HSK A 63 SEM1-1/4X2.375	63	1.250	0.669	2.510	2.375	1.351
HSK A 63 SEM1-1/2X2.375	63	1.500	0.940	3.070	2.375	1.351
HSK A 100 SEM3/4X3.000	100	0.750	0.669	1.770	3.000	1.858
HSK A 100 SEM1X2.375	100	1.000	0.669	2.165	2.375	1.233
HSK A 100 SEM1-1/4X1.875	100	1.250	0.669	2.500	1.875	0.733
HSK A 100 SEM1-1/2X1.875	100	1.500	0.940	3.071	1.875	0.733
HSK A 100 SEM2 X2.375	100	2.000	0.940	3.881	2.375	1.233

* Requires a price and delivery time quotation.

- A cooling tube must be used with all coolant through HSK spindles (should be ordered separately).
- Applicable for 7 MPa pressure coolant.

(Option:Wrench for lock screw)

Metric	$\varnothing SS$	$\varnothing d$	$L2$	$\varnothing D1$	L	$L1$
HSKA40SEM22	40	22	30	47	50	19
HSKA40SEM27	40	27	35	58	55	21
HSKA50SEM16X50	50	16	24	50	38	17
HSKA50SEM22X60	50	22	34	60	47	19
HSKA50SEM27X60	50	27	34	60	58	21
HSKA63SEM16X50	63	16	24	50	38	17
HSKA63SEM22X50	63	22	24	50	47	19
HSKA63SEM27X60	63	27	34	60	58	21
HSKA63SEM32X60	63	32	34	60	66	24
HSKA63SEM40X60	63	40	34	60	82	27
HSKA100SEM22X50 ⁽¹⁾	100	22	21	50	47	19
HSKA100SEM27X50 ⁽¹⁾	100	27	21	50	58	21
HSKA100SEM32X50 ⁽¹⁾	100	32	21	50	66	24
HSKA100SEM40X60 ⁽¹⁾	100	40	31	60	82	27
HSKA100SEM50X70 ⁽¹⁾	100	50	41	70	95	30

⁽¹⁾ Balanced to G6.3 12,000 min⁻¹.

- A cooling tube must be used with all coolant through HSK spindles (should be ordered separately).
- Applicable for 7 MPa pressure coolant.

(Option:Wrench for lock screw)

Reference pages



Clamping screw

F122



Wrench

F124, F125



Cooling tube

F124

TUNGHOLD

HSK FM-SEM (Shell mill holder)

Shell mill holder with HSK-FM shank



Tooling System

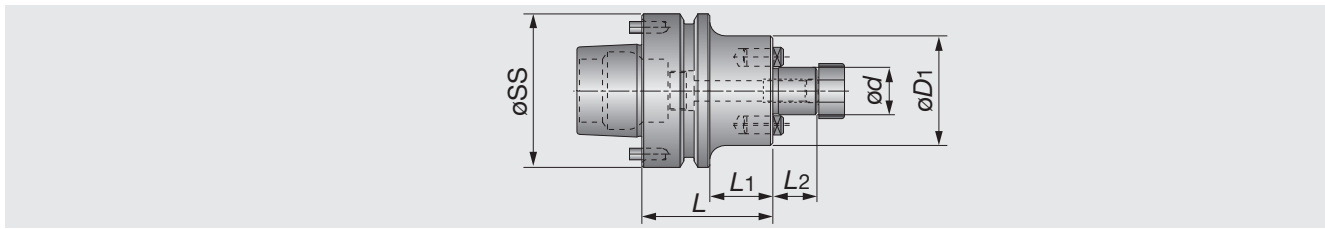

Inch	øSS	ød	L2	øD1	L	L1
HSK FM63 SEM 3/4X3.00	63	0.750	0.669	1.772	3.000	1.976
HSK FM63 SEM 3/4X4.50	63	0.750	0.669	1.772	4.500	3.476
HSK FM63 SEM 1X2.375	63	1.000	0.669	2.079	2.375	1.351
HSK FM80 SEM 3/4X2.00	80	0.750	0.669	1.772	2.000	0.976
HSK FM80 SEM 3/4X4.00	80	0.750	0.669	1.772	4.000	2.976
HSK FM80 SEM 1X2.00	80	1.000	0.669	2.165	2.000	0.976
HSK FM80 SEM 1X4.00	80	1.000	0.669	2.165	4.000	2.976

- A cooling tube must be used with all coolant through HSK spindles (should be ordered separately).
- The orientation pins can be removed, turning the toolholder into a standard HSK F63 type.
- Applicable for 7 MPa pressure coolant.

(Option:Wrench for lock screw)

Metric	øSS	ød	L2	øD1	L	L1
HSKFM63SEM22X60	63	22	19	47	60	34
HSKFM63SEM27X60	63	27	21	58	60	34
HSKFM63SEM32X60	63	32	24	66	60	34
HSKFM63SEM3/4X3.00	63	19.05	17	45	76.2	50.2
HSKFM63SEM3/4X4.50	63	19.05	17	45	114.3	88.3
HSKFM63SEM1X2.375	63	25.4	17	52.8	60.3	34.3

- A cooling tube must be used with all coolant through HSK spindles (should be ordered separately).
- The orientation pins can be removed, turning the toolholder into a standard HSK F63 type.
- Applicable for 7 MPa pressure coolant.

(Option:Wrench for lock screw)

TUNGHOLD

Reference pages



Clamping screw

F122



Wrench

F124, F125



Cooling tube

F124

TUNGHOLD

HSK A-FM (Face mill holder)

Face mill holder with HSK-A shank

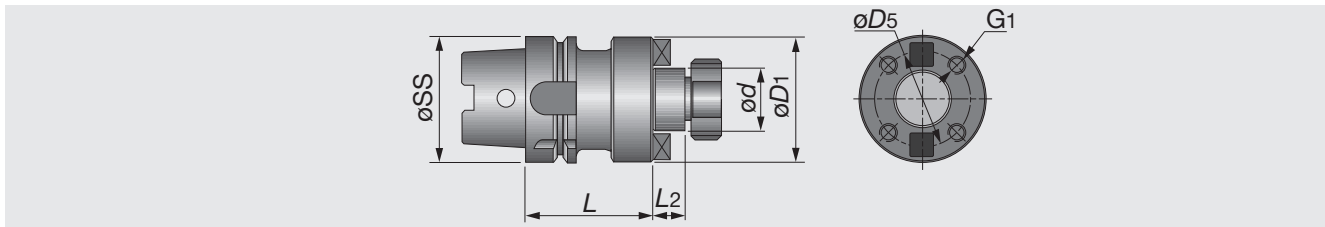

Inch	øSS	ød	L2	øD1	L	øD5	G1
HSK A 100 FM 2-1/2X2.875	100	2.500	1.122	4.881	2.875	4.000	5/8-11

(Option:Wrench for lock Screw)

TUNGHOLD

HSK A-SEMC (Combination holder for slot mill & shell mill)

Combination holder with HSK-A shank

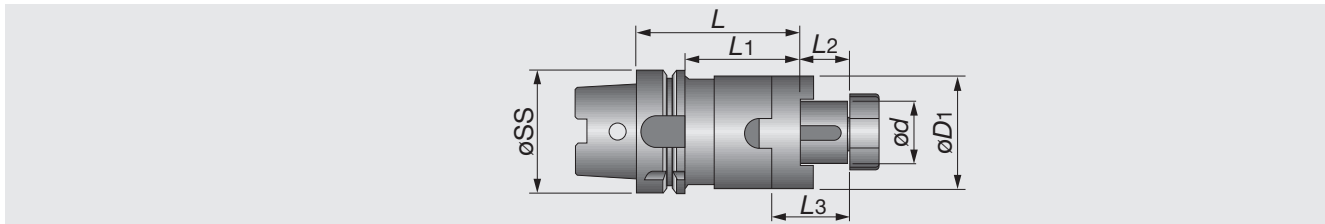

Metric	øSS	ød	L2	øD1	L	L1	L3
HSKA50SEMC16X50	50	16	17	32	50	24	27
HSKA50SEMC27X65	50	27	21	48	65	39	33
HSKA63SEMC16X60	63	16	17	32	60	34	21
HSKA63SEMC22X60	63	22	19	40	60	34	31
HSKA63SEMC27X60	63	27	21	48	60	34	33
HSKA63SEMC32X60	63	32	24	58	60	34	38
HSKA63SEMC40X70	63	40	27	70	70	44	41
HSKA100SEMC16X60	100	16	17	32	60	31	27
HSKA100SEMC22X60	100	22	19	40	60	31	31
HSKA100SEMC27X60	100	27	21	48	60	31	33
HSKA100SEMC32X60	100	32	24	58	60	31	38
HSKA100SEMC40X70	100	40	27	70	70	41	41
HSKA100SEMC50X80	100	50	30	90	80	51	46

• Applicable for 7 MPa pressure coolant.

(Option:Wrench for lock Screw)

Reference pages



F122

F124, F125

F124

TUNGHOLD

HSK A-MT (Holder for Morse taper)

Morse taper holder with HSK-A shank



Tooling System

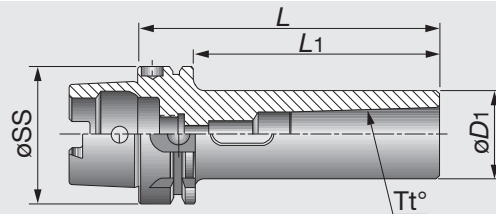

Metric	øSS	Tt°	L	øD1	L1
HSKA50MT1X100	50	MT1	100	25	74
HSKA50MT2X120	50	MT2	120	32	94
HSKA50MT3X140	50	MT3	140	40	114
HSKA63MT1X110	63	MT1	110	25	84
HSKA63MT2X120	63	MT2	120	32	94
HSKA63MT3X140	63	MT3	140	40	114
HSKA63MT4X160	63	MT4	160	48	134
HSKA100MT1X110	100	MT1	110	25	81
HSKA100MT2X120	100	MT2	120	32	91
HSKA100MT3X150	100	MT3	150	40	121
HSKA100MT4X170	100	MT4	170	48	141
HSKA100MT5X200	100	MT5	200	63	171

TUNGHOLD

ADJ HSK A-ER (Collet chuck holder)

ER Collet Chucks with Center Alignment for HSK-A Shanks

TUNGHOLD

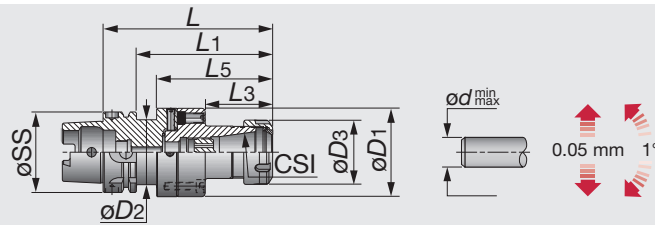

Metric	øSS	CSI	ødmin	ødmax	L	L1	L5	L3	øD3	øD1	øD2
ADJHСКА63D70ER32	63	ER32	2	20	134.5	108.5	92.5	52.5	50	70	46
ADJHСКА100D70ER32	100	ER32	2	20	129.5	100.5	82.5	52.5	50	70	-

• Applicable for 10 MPa pressure coolant.

(Option: Wrench for ER Collet)

Reference pages



TUNGBORE

TUNGBORE-HSK A (Adjustable holder for indexable drill)

TungBore adjustable drilling dia. holder with HSK-A shank

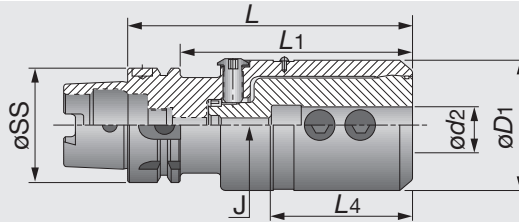

Metric	øSS	ød2	øD1	L	L1	L4	J
TUNGBOREHСКА63EM25	63	25	72	142	116	71	M10
TUNGBOREHСКА63EM32	63	32	72	142	116	71	M10
TUNGBOREHСКА63EM40	63	40	72	142	116	71	M10

• Applicable for 7 MPa pressure coolant.

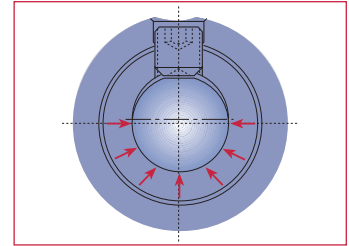
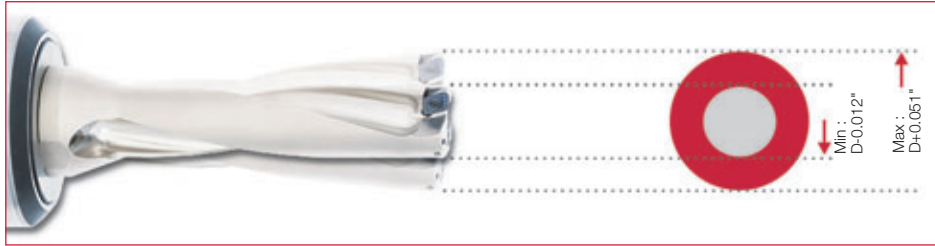

The bore's section is actually made from two shifted circular sections. The clamping screw pushes the drill shank through a narrowed opening, forcing elastic deformation of the holder. Contact is made around more than 180°, providing a high clamping force.

TUNGCLICK

HSK A-CLICKIN (Quick change holder)

TungClick quick change tooling system with HSK-A shank

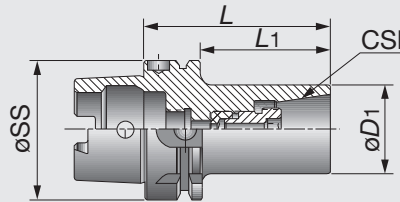

Metric	øSS	CSI	øD1	L	L1
HSKA63ER32CLICK-IN	63	32SRF	41	85	59
HSKA100ER32CLICK-IN	100	32SRF	41	90	61

• Tightening torque: 235 N-m

TUNGFIT

HSK A-CF (Quick change holder)

TungFit quick change style modular tooling system with HSK-A shank

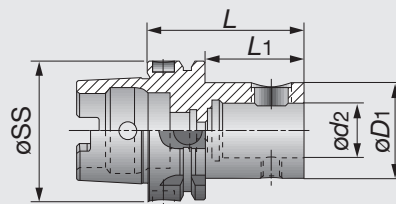

Metric	øSS	ød2	øD1	L	L1
HSKA63CF4-S	63	25	44.5	70	44
HSKA80CF4-S	80	25	44.5	73	47
HSKA100CF4-S	100	25	44.5	76	47

• Tightening torque: 58.8 N-m • Applicable for 7 MPa pressure coolant.

Reference pages



Wrench

F125



Cooling tube

F124

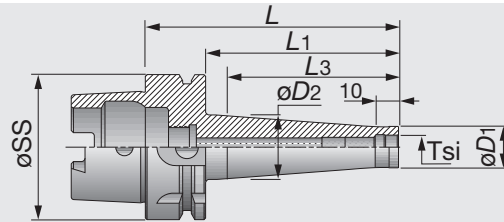

Metric	øSS	Tsi	øD1	øD2	L	L1	L3
HSKA63ODP6X59	63	M6	9.7	10	59	33	25
HSKA63ODP6X109	63	M6	9.8	23	109	83	75
HSKA63ODP8X59	63	M8	13.1	15	59	33	25
HSKA63ODP8X109	63	M8	13.1	23	109	83	75
HSKA63ODP10X59	63	M10	18	20	59	33	25
HSKA63ODP10X109	63	M10	18	28	109	83	75
HSKA63ODP12X59	63	M12	21	24	59	33	25
HSKA63ODP12X109	63	M12	21	31	109	83	75
HSKA63ODP16X59	63	M16	29	34	59	33	25
HSKA63ODP16X109	63	M16	29	34	109	83	75
HSKA100ODP12X87 ⁽¹⁾	100	M12	23	30	87	58	50
HSKA100ODP12X137 ⁽¹⁾	100	M12	23	30	137	108	100
HSKA100ODP12X187 ⁽¹⁾	100	M12	23	40	187	158	150
HSKA100ODP12X237 ⁽¹⁾	100	M12	23	46	237	208	200
HSKA100ODP16X87 ⁽¹⁾	100	M12	29	31.5	87	58	50
HSKA100ODP16X137 ⁽¹⁾	100	M12	29	41.5	137	108	100
HSKA100ODP16X187 ⁽¹⁾	100	M12	29	55	187	158	150
HSKA100ODP16X237 ⁽¹⁾	100	M12	29	55	237	208	200

(1) Balanced to G6.5 12,000 min⁻¹. • Applicable for 10 MPa pressure coolant.

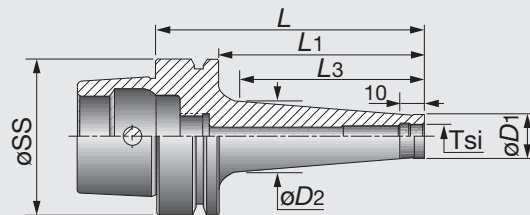

Metric	øSS	Tsi	øD1	øD2	L	L1	L3
HSKE40ODP10X53	40	M10	18	20	53	33	25
HSKE40ODP10X103	40	M10	18	28	103	83	75
HSKE40ODP12X53	40	M12	21	24	53	33	25
HSKE40ODP12X103	40	M12	21	31	103	83	75
HSKE50ODP10X59 ⁽¹⁾	50	M10	18	20	59	33	25
HSKE50ODP10X109 ⁽¹⁾	50	M10	18	28	109	83	75
HSKE50ODP12X59 ⁽¹⁾	50	M12	21	24	59	33	25
HSKE50ODP12X109 ⁽¹⁾	50	M12	21	31	109	83	75
HSKE50ODP16X59 ⁽¹⁾	50	M16	29	34	59	33	25
HSKE50ODP16X109 ⁽¹⁾	50	M16	29	34	109	83	75
HSKE63ODP10X59 ⁽²⁾	63	M10	18	20	59	33	25
HSKE63ODP10X109 ⁽²⁾	63	M10	18	28	109	83	75
HSKE63ODP12X59 ⁽²⁾	63	M12	21	24	59	33	25
HSKE63ODP12X109 ⁽²⁾	63	M12	21	31	109	83	75
HSKE63ODP16X109 ⁽²⁾	63	M16	29	34	109	83	75

(1) Balanced to G2.5 35,000 min⁻¹. (2) Balanced to G2.5 30,000 min⁻¹. • Applicable for 10 MPa pressure coolant.

Reference pages



Wrench
F125



Cooling tube
F124



TUNGHOLD

HSK Blanks

Blanks for holders with HSK shank

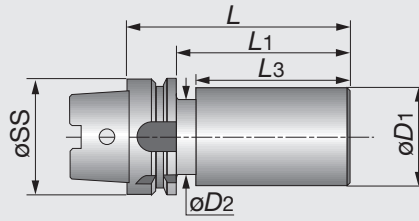

Metric	ϕSS	$\phi D1$	$\phi D2$	L	L1	L3
HSKA50B16MN100	50	53	41.8	100	74	58
HSKA50B16MN200	50	53	41.8	200	174	158
HSKA63B16MN100	63	63	52.8	100	74	55.5
HSKA63B16MN200	63	63	52.8	200	174	155.5
HSKA100B16MN100	100	102	85	100	71	54.8
HSKA100B16MN200	100	102	85	200	171	154.8

- Material: Case hardened alloy steel.
- Shank hardness 58 HRc minimum.
- Nose hardness 35-37 HRc.

Reference pages



Wrench

F125



Cooling tube

F124

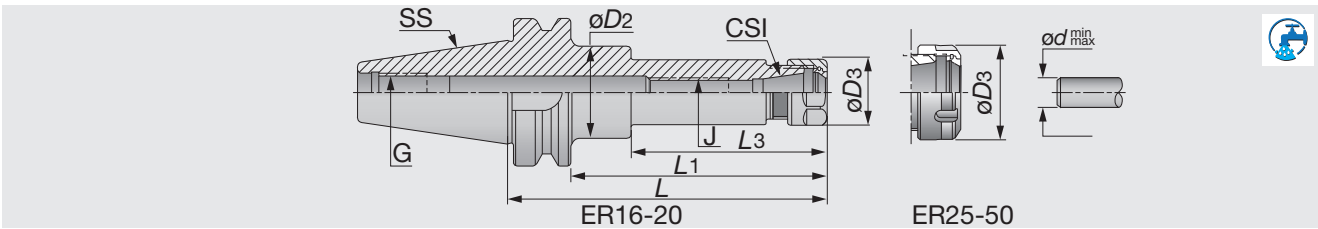

Inch	SS	CSI	ødmin	ødmax	L	L1	L3	øD3	øD2	J	G
CAT30 ER16X2.750 ⁽¹⁾	30	ER16	0.022	0.396	2.75	1.37	-	1.102	1.248	M10	1/2-13
CAT30 ER16X2.750 ⁽¹⁾	30	ER16	0.041	0.514	2.562	1.102	-	1.248	1.248	M12	1/2-13
CAT30 ER16X2.750 ⁽¹⁾	30	ER16	0.022	0.396	2.75	1.37	-	1.102	1.752	M12	5/8-11
CAT40 ER16X3.937	40	ER16	0.022	0.396	3.937	1.37	-	1.102	1.752	M12	5/8-11
CAT40 ER16X5.906	40	ER16	0.022	0.396	5.906	3.35	-	1.102	1.752	M12	5/8-11
CAT40 ER20X3.937	40	ER20	0.041	0.514	3.937	2.56	-	1.339	1.752	M12	5/8-11
CAT40 ER20X5.906	40	ER20	0.041	0.514	5.906	3.78	110	1.339	1.752	M12	5/8-11
CAT50 ER16X3.937 ⁽¹⁾	50	ER16	0.022	0.396	3.937	2.56	85	1.102	2.752	M12	1-8
CAT50 ER16X5.906 ⁽¹⁾	50	ER16	0.022	0.396	5.906	3.49	-	1.102	2.752	M12	1-8
CAT50 ER16X8.000 ⁽¹⁾	50	ER16	0.022	0.396	8	2.98	-	1.102	2.752	M12	1-8
CAT50 ER20X3.937 ⁽¹⁾	50	ER20	0.041	0.514	3.937	2.56	-	1.349	2.752	M16	1-8
CAT50 ER20X5.906 ⁽¹⁾	50	ER20	0.041	0.514	5.906	4.53	-	1.349	2.752	M16	1-8
CAT50 ER20X8.000 ⁽¹⁾	50	ER20	0.041	0.514	8	4.62	-	1.349	2.752	M16	1-8
CAT30 ER32X3.268 ⁽¹⁾	30	ER32	0.08	0.789	3.268	1.89	-	1.968	1.248	M18X1.5	1/2-13
CAT40 ER25X2.562	40	ER25	0.041	0.632	2.562	1.18	-	1.654	1.752	M16	5/8-11
CAT40 ER25X4.000	40	ER25	0.041	0.632	4	2.62	-	1.654	1.752	M16	5/8-11
CAT40 ER25X6.000	40	ER25	0.041	0.632	6	4.62	-	1.654	1.752	M16	5/8-11
CAT40 ER32X2.562	40	ER25	0.08	0.789	2.562	-	85	1.968	1.752	M22X1.5	5/8-11
CAT40 ER32X4.000	40	ER25	0.08	0.789	4	-	-	1.968	1.752	M22X1.5	5/8-11
CAT40 ER32X6.000	40	ER25	0.08	0.789	6	-	-	1.968	1.752	M22X1.5	5/8-11
CAT40 ER40X3.359	40	ER40	0.12	1.025	3.359	-	-	2.48	1.752	M28X1.5	5/8-11
CAT40 ER40X4.000	40	ER40	0.12	1.025	4	-	85	2.48	1.752	M28X1.5	5/8-11
CAT50 ER25X4.000 ⁽¹⁾	50	ER25	0.041	0.632	4	2.58	-	1.654	2.752	M16	1-8
CAT50 ER25X6.000 ⁽¹⁾	50	ER25	0.041	0.632	6	4.62	-	1.654	2.752	M16	1-8
CAT50 ER25X8.000 ⁽¹⁾	50	ER25	0.041	0.632	8	6.58	-	1.654	2.752	M16	1-8
CAT50 ER32X4.000 ⁽¹⁾	50	ER32	0.08	0.789	4	2.54	-	1.968	2.752	M22X1.5	1-8
CAT50 ER32X6.000 ⁽¹⁾	50	ER32	0.08	0.789	6	4.58	-	1.968	2.752	M22X1.5	1-8
CAT50 ER32X8.000 ⁽¹⁾	50	ER32	0.08	0.789	8	6.58	-	1.968	2.752	M22X1.5	1-8
CAT50 ER40X4.000 ⁽¹⁾	50	ER40	0.12	1.025	4	2.62	-	2.48	2.752	M28X1.5	1-8
CAT50 ER40X6.000 ⁽¹⁾	50	ER40	0.12	1.025	6	4.62	-	2.48	2.752	M28X1.5	1-8
CAT50 ER40X8.000 ⁽¹⁾	50	ER40	0.12	1.025	8	6.58	-	2.48	2.752	M28X1.5	1-8
CAT50 ER50X4.000 ⁽¹⁾	50	ER50	0.396	1.338	4	-	-	3.07	2.752	M36X1.5	1-8
CAT50 ER50X6.000 ⁽¹⁾	50	ER50	0.396	1.338	6	-	-	3.07	2.752	M36X1.5	1-8

(1) Balanced to G6.3 at 12,000 min⁻¹.

(2) ER11 MINI Collet Chuck Spec.

- Add B for coolant through the flange.
- Wrench is not included.
- Applicable for 10 MPa pressure coolant.

(Option:Wrench for ER Collet)

Reference pages



ER Collet

F099



Nut

F118



Wrench

F120



Preset screws

F121

TUNGSHORT

CAT-ER collet (Collet chuck holder for short overhang)

TungShort collet chucks with CAT shank

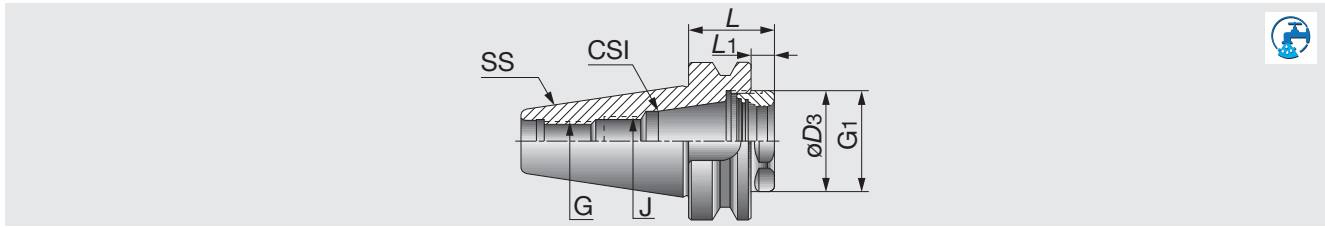

Inch	SS	CSI	Range	L	L1	øD3	J	G	G1
CAT40 ER32 SHORT	40	ER20	0.08 - 0.789	1.124	0.374	1.575	5/8X1 1	5/8X11	M40X1.5
CAT40 ER32 SHORT M	40	ER32	0.08 - 0.789	1.754	1	1.575	5/8X11	5/8X11	M40X1.5
CAT40 ER40 SHORT	40	ER32	0.12 - 1.025	2.124	1.37	1.969	5/8X11	5/8X11	M50X1.5
CAT50 ER32 SHORT	50	ER32	0.08 - 0.789	1.124	0.374	1.575	M22X1.5	1-8	M40X1.5
CAT50 ER32 SHORT M	50	ER32	0.08 - 0.789	1.754	1	1.575	M22X1.5	1-8	M40X1.5
CAT50 ER40 SHORT	50	ER40	0.12 - 1.025	1.124	0.374	1.969	M28X1.5	1-8	M50X1.5
CAT50 ER40 SHORT M	50	ER40	0.12 - 1.025	1.754	1	1.969	M28X1.5	1-8	M50X1.5

- Add B for coolant through the flange.
- Applicable for 10 MPa pressure coolant.

(Option:Wrench for ER Collet)

TUNGBALANCE

CAT-ER BIN (Collet chuck holder)

TungBalance adjustable dynamic balance collet chuck holder with CAT shank

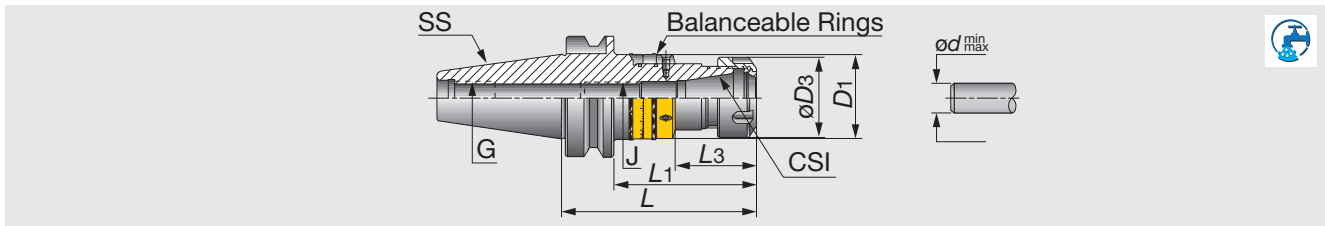

Inch	SS	CSI	ød _{min}	ød _{max}	L	L1	L3	øD3	øD1	G	J
CAT40 ER16X4.000 BIN	40	ER16	0.022	0.396	4	3.25	1.68	1.102	1.73	5/8-11	M12
CAT40 ER16X6.000 BIN	40	ER16	0.022	0.396	6	5.25	2.94	1.102	1.73	5/8-11	M12
CAT40 ER20X4.000 BIN	40	ER20	0.041	0.514	4	3.25	1.68	1.339	1.73	5/8-11	M12
CAT40 ER20X6.000 BIN	40	ER20	0.041	0.514	6	5.25	3.68	1.339	1.73	5/8-11	M12
CAT40 ER25X4.000 BIN	40	ER25	0.041	0.632	4	3.25	1.68	1.654	1.73	5/8-11	M16
CAT40 ER25X6.000 BIN	40	ER25	0.041	0.632	6	5.25	3.68	1.654	1.73	5/8-11	M16
CAT40 ER32X4.000 BIN	40	ER32	0.08	0.789	4	3.25	1.5	1.968	2.36	5/8-11	M22X1.5
CAT40 ER32X6.000 BIN	40	ER32	0.08	0.789	6	5.25	3.5	1.968	2.36	5/8-11	M22X1.5
CAT40 ER40X4.000 BIN	40	ER40	0.12	1.025	4	3.25	1.46	2.48	2.36	5/8-11	M28X1.5

- Balanced to G2.5 20,000 min-1.
- Applicable for 10 MPa pressure coolant.

(Option:Wrench for ER Collet)

Reference pages



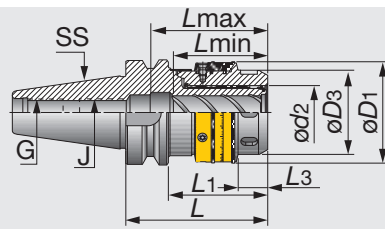

Inch	SS	ød2	Range	L	L1	øD3	øD2	Lmin	Lmax	J	G
CAT40 TUNGMAX 1-1/4X4.16BIN ⁽¹⁾	40	1.25	0.25 - 1.25	4.16	3.41	3.141	0.98	2.76	3.23	M16	5/8-11
CAT40 TUNGMAX 3/4X3.75BIN ⁽¹⁾	40	0.75	0.25 - 0.75	3.744	2.992	2.394	0.689	2.19	2.72	M16	5/8-11
CAT50 TUNGMAX 1-1/4X4.05BIN ⁽¹⁾	50	1.25	0.25 - 1.25	4.05	3.3	3.141	0.98	2.76	3.31	M20X2	1-8
CAT50 TUNGMAX 3/4X4.13BIN ⁽¹⁾	50	0.75	0.25 - 0.75	4.138	3.386	2.394	0.689	2.19	2.72	M16	1-8

(1) Balanced to G6.3 at 8,000 min-1.
 • Applicable for 10 MPa pressure coolant.

(Option:Wrench for TungMax collet)

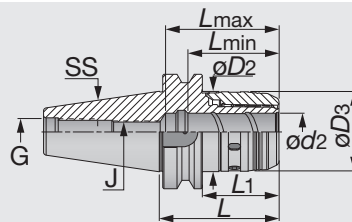

Inch	SS	ød2	Range	øD3	øD1	L	L1	L3	Lmin	Lmax	J	G
CAT40 TUNGMAX 1-1/4X4.16	40	1.25	0.25 - 1.25	2.717	2.756	4.16	3.41	-	2.76	3.23	M16	5/8-11
CAT40 TUNGMAX 3/4X3.75	40	0.75	0.25 - 0.75	2	2.087	3.744	2.992	2.362	2.19	2.72	M16	5/8-11
CAT50 TUNGMAX 1-1/4X4.05	50	1.25	0.25 - 1.25	2.717	2.752	4.05	3.3	-	2.76	3.31	M20X2	1-8
CAT50 TUNGMAX 1-1/4X5.314	50	1.25	0.25 - 1.25	2.717	2.752	5.315	4.565	-	2.78	3.34	M20X2	1-8
CAT50 TUNGMAX 3/4X4.13	50	0.75	0.25 - 0.75	2	2.087	4.138	3.386	2.244	2.19	2.72	M16	1-8

(1) Chucks with taper size 40 can be balanced by the balancing ring up to G2.5 at 20,000 min-1.
 (2) Chucks with taper size 50 can be balanced by the balancing ring up to G2.5 at 18,000 min-1.
 • Applicable for 10 MPa pressure coolant.

(Option:Wrench for TungMax collet)

Reference pages



Straight collet

F028



Wrench

F120



TUNGHYDRO

CAT-HYDRO (Hydro chuck holder)

TungHydro hydraulic endmill chuck holders with CAT shank

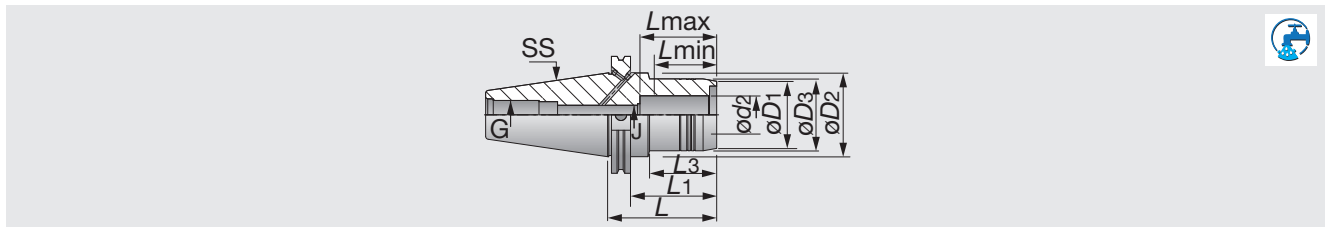

Inch	SS	øD2	øD1	øD3	øD2	L	L1	L3	Lmin	Lmax	J	G
CAT40 HYDRO 1/4X2.677	40	0.25	0.906	1.023	1.75	2.677	1.927	1.299	1.06	1.46	M5	5/8"-11UNC
CAT40 HYDRO 3/8X2.835	40	0.375	1.063	1.181	1.75	2.834	2.083	1.456	1.26	1.65	M6	5/8"-11UNC
CAT40 HYDRO 1/2X3.031	40	0.5	1.142	1.259	1.75	3.031	2.279	1.653	1.46	1.85	M8X1	5/8"-11UNC
CAT40 HYDRO 5/8X3.149	40	0.625	1.339	1.496	1.75	3.149	2.397	1.692	1.65	2.05	M8X1	5/8"-11UNC
CAT40 HYDRO 3/4X3.228	40	0.75	1.496	1.653	1.75	3.228	2.476	1.85	1.65	2.05	M12X1	5/8"-11UNC
CAT40 HYDRO 1X3.228	40	1	1.811	1.968	1.75	3.228	2.476	2.007	1.89	2.28	M16X1	5/8"-11UNC
CAT40 HYDRO 1 1/4X4.331	40	1.25	2.205	2.559	1.75	4.331	2.832	2.204	2.05	2.44	M16X1	5/8"-11UNC
CAT50 HYDRO 1/4X2.677	50	0.25	0.906	1.023	2.75	2.667	1.925	1.299	1.06	1.46	M5	1"-8 UNC
CAT50 HYDRO 3/8X2.834	50	0.375	1.063	1.181	2.75	2.834	2.083	1.456	1.26	1.65	M6	1"-8 UNC
CAT50 HYDRO 1/2X3.228	50	0.5	1.142	1.259	2.75	3.228	2.476	1.653	1.46	1.85	M10	1"-8 UNC
CAT50 HYDRO 5/8X3.149	50	0.625	1.339	1.496	2.75	3.149	2.397	1.574	1.65	2.05	M8X1	1"-8 UNC
CAT50 HYDRO 3/4X3.228	50	0.75	1.496	1.653	2.75	3.228	2.476	1.79	1.65	2.05	M12X1	1"-8 UNC
CAT50 HYDRO 1X3.228	50	1	1.811	1.968	2.75	3.228	2.476	1.771	1.65	2.28	M16X1	1"-8 UNC
CAT50 HYDRO 1 1/4X3.583	50	1.25	2.205	2.362	2.75	3.583	2.83	2.204	2.05	2.52	M16X1	1"-8 UNC

- Chucking forces will be reduced by 25% if reduction sleeves are used.
- Reduction sleeves are available for 3/4 and 1-1/4 " bore diameters (ordered separately).
- The coolant passages in the B type flange are blocked with screws which can be removed when required.
- Clamping wrench (WRENCH HYDRO HEX 4) and test bar should be ordered separately.
- Applicable for 10 MPa pressure coolant.

Reference pages



Straight collet
F111

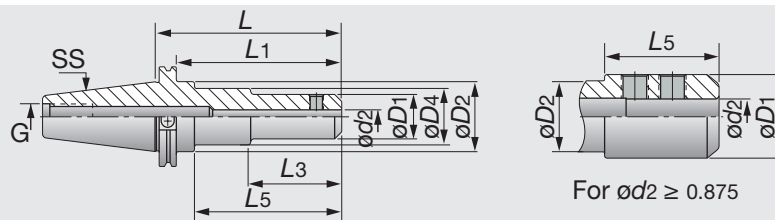

Inch	SS	ød2	øD1	øD2	øD4	L	L1	L3	L5	G
CAT40 EM 3/16X2.500	40	0.187	0.866	1.752	-	2.5	1.75	-	1.121	5/8-11
CAT40 EM 1/4X2.500	40	0.25	1	1.752	-	2.5	1.75	-	1.121	5/8-11
CAT40 EM 3/8 X1.750 ⁽¹⁾	40	0.375	1.5	1.752	-	1.75	1	-	-	5/8-11
CAT40 EM 3/8X2.500	40	0.375	1.248	1.752	-	2.5	1.75	-	1.121	5/8-11
CAT40 EM 3/8 X2.500 B ⁽¹⁾	40	0.375	1.248	1.752	-	2.5	1.75	-	1.121	5/8-11
CAT40 EM 1/2X1.750 ⁽¹⁾	40	0.5	1.5	1.752	-	1.75	1	-	-	5/8-11
CAT40 EM 1/2X2.625	40	0.5	1.752	1.752	-	2.625	1.875	-	-	5/8-11
CAT40 EM 1/2 X2.625 B ⁽¹⁾	40	0.5	1.752	1.752	-	2.625	1.875	-	-	5/8-11
CAT40 EM 5/8X1.750 ⁽¹⁾	40	0.625	1.5	1.752	-	1.75	1	-	-	5/8-11
CAT40 EM 5/8X3.750	40	0.625	1.752	1.752	-	3.75	3	-	-	5/8-11
CAT40 EM 5/8 X3.750 B ⁽¹⁾	40	0.625	1.752	1.752	-	3.75	3	-	-	5/8-11
CAT40 EM 3/4X1.750	40	0.75	1.75	1.752	-	1.75	1	-	-	5/8-11
CAT40 EM 3/4X3.750	40	0.75	1.752	1.752	-	3.75	3	-	-	5/8-11
CAT40 EM 3/4X3.750 B ⁽¹⁾	40	0.75	1.752	1.752	-	3.75	3	-	-	5/8-11
CAT40 EM 7/8X4.000	40	0.875	2.047	1.752	-	4	3.25	-	2.62	5/8-11
CAT40 EM 1 X1.750 ⁽¹⁾	40	1	2	1.752	-	1.75	1	-	-	5/8-11
CAT40 EM 1 X1.750 B ⁽¹⁾	40	1	2	1.752	-	1.75	1	-	-	5/8-11
CAT40 EM 1X4.000	40	1	2.559	1.752	-	4	3.25	-	2.62	5/8-11
CAT40 EM 1X4.000 B ⁽¹⁾	40	1	2.559	1.752	-	4	3.25	-	2.62	5/8-11
CAT40 EM 1-1/4X2.000 ⁽¹⁾	40	1.25	2.25	1.752	-	2	1.25	-	-	5/8-11
CAT40 EM 1-1/4X4.250	40	1.25	2.752	1.752	-	4.25	3.5	-	2.87	5/8-11
CAT40 EM 1-1/4X4.250 B ⁽¹⁾	40	1.25	2.752	1.752	-	4.25	3.5	-	2.87	5/8-11
CAT40 EM 1-1/2X4.625	40	1.5	3.15	1.752	-	4.625	3.875	-	3.245	5/8-11
CAT40 EM 1-1/2X4.625 B ⁽¹⁾	40	1.5	3.15	1.752	-	4.625	3.875	-	3.245	5/8-11
CAT50 EM 1/4 X2.500	50	0.25	1	2.752	-	2.5	1.75	-	1.12	1-8
CAT50 EM 1/4 X4.500	50	0.25	1	2.752	-	4.5	3.75	-	3.15	1-8
CAT50 EM 1/4 X6.250	50	0.25	1	2.752	1.969	6.25	5.5	2.756	4.87	1-8
CAT50 EM 3/8 X2.500	50	0.375	1.248	2.752	-	2.5	1.75	-	1.12	1-8
CAT50 EM 3/8 X2.500 B ⁽¹⁾	50	0.375	1.248	2.752	-	2.5	1.75	-	1.12	1-8
CAT50 EM 3/8 X4.500	50	0.375	1.248	2.752	-	4.5	3.75	-	3.12	1-8
CAT50 EM 3/8X6.500	50	0.375	1.248	2.753	1.969	6.5	5.5	3.13	5.12	1-8
CAT50 EM 3/8X6.500 B ⁽¹⁾	50	0.375	1.248	2.753	1.969	6.5	5.5	3.13	5.12	1-8
CAT50 EM 1/2 X2.625	50	0.5	1.752	2.752	-	2.625	1.875	-	1.245	1-8
CAT50 EM 1/2 X2.625 B ⁽¹⁾	50	0.5	1.752	2.752	-	2.625	1.875	-	1.245	1-8
CAT50 EM 1/2 X4.625	50	0.5	1.752	2.752	-	4.625	3.875	-	3.245	1-8
CAT50 EM 1/2X4.625 B ⁽¹⁾	50	0.5	1.752	2.752	-	4.625	3.875	-	3.245	1-8
CAT50 EM 1/2X6.625	50	0.5	1.752	2.752	2.205	6.625	5.875	3.248	5.245	1-8
CAT50 EM 1/2X6.625 B ⁽¹⁾	50	0.5	1.752	2.752	2.205	6.625	5.875	3.248	5.245	1-8
CAT50 EM 5/8 X3.750	50	0.625	1.752	2.752	-	3.75	3	-	2.37	1-8
CAT50 EM 5/8 X3.750 B ⁽¹⁾	50	0.625	1.752	2.752	-	3.75	3	-	2.37	1-8
CAT50 EM 5/8X5.750	50	0.625	1.752	2.752	-	5.75	5	-	4.37	1-8
CAT50 EM 5/8X5.750 B ⁽¹⁾	50	0.625	1.752	2.752	-	5.75	5	-	4.37	1-8
CAT50 EM 5/8X7.750	50	0.625	1.752	2.753	2.165	7.75	7	4.39	6.37	1-8

- Add B for coolant through the flange.
- These tool holders can be used only on vertical machines with an umbrella type ATC.
(They cannot be used with arm type ATC.)
- Applicable for 7 MPa pressure coolant.

Reference pages



Lock Screw

F123



TUNGHOLD

CAT-EM (endmill holder)

Screw locking endmill holders with CAT shank

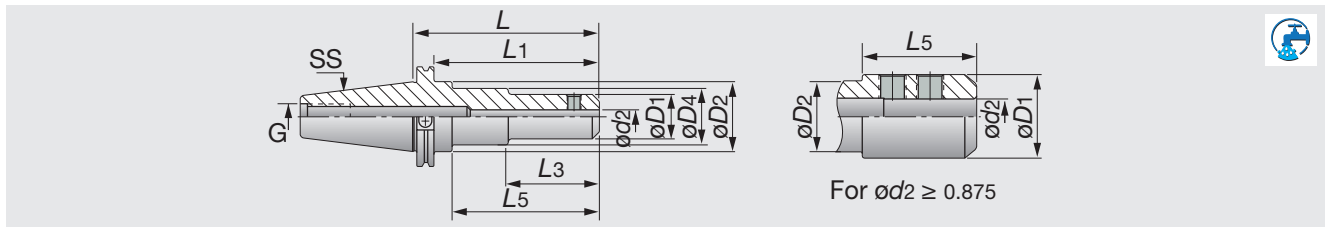

Inch	SS	ød2	øD1	øD2	øD4	L	L1	L3	L5	G
CAT50 EM 3/4 X3.750	50	0.75	1.772	2.752	-	3.75	3	-	2.37	1-8
CAT50 EM 3/4X3.750 B ⁽¹⁾	50	0.75	1.772	2.752	-	3.75	3	-	2.37	1-8
CAT50 EM 3/4 X5.750	50	0.75	1.772	2.752	-	5.75	5	-	3.15	1-8
CAT50 EM 3/4 X5.750 B ⁽¹⁾	50	0.75	1.772	2.752	-	5.75	5	-	3.15	1-8
CAT50 EM 3/4 X7.750	50	0.75	1.772	2.753	2.264	7.75	7	3.15	6.37	1-8
CAT50 EM 3/4 X7.750 B ⁽¹⁾	50	0.75	1.772	2.753	2.264	7.75	7	3.15	6.37	1-8
CAT50 EM 7/8 X7.750	50	0.75	2.047	2.752	-	7.75	7	-	3.15	1-8
CAT50 EM 7/8 X3.750	50	0.875	2.047	2.752	-	3.75	3	-	2.37	1-8
CAT50 EM 1 X4.000	50	1	2.559	2.753	-	4	3.25	-	2.62	1-8
CAT50 EM 1X4.000 B ⁽¹⁾	50	1	2.559	2.753	-	4	3.25	-	2.62	1-8
CAT50 EM 1 X6.000	50	1	2.559	2.752	-	6	5.25	-	4.62	1-8
CAT50 EM 1 X6.000 B ⁽¹⁾	50	1	2.559	2.752	-	6	5.25	-	4.62	1-8
CAT50 EM 1 X8.000	50	1	2.559	2.752	-	8	7.25	-	4.625	1-8
CAT50 EM 1-1/4X4.000	50	1.25	2.752	2.752	-	4	3.25	-	-	1-8
CAT50 EM 1-1/4X4.000 B ⁽¹⁾	50	1.25	2.752	2.752	-	4	3.25	-	-	1-8
CAT50 EM 1-1/4X6.000	50	1.25	2.752	2.752	-	6	5.25	-	-	1-8
CAT50 EM 1-1/4X8.000	50	1.25	2.752	2.752	-	8	7.25	-	-	1-8
CAT50 EM 1-1/2X4.000	50	1.5	3.15	2.752	-	4	3.25	-	2.62	1-8
CAT50 EM 1-1/2X4.000 B ⁽¹⁾	50	1.5	3.15	2.752	-	4	3.25	-	2.62	1-8
CAT50 EM 1-1/2X6.000	50	1.5	3.15	2.752	-	6	5.25	-	4.62	1-8
CAT50 EM 1-1/2X8.000	50	1.5	3.15	2.752	-	8	7.25	-	6.62	1-8
CAT50 EM 2 X5.625	50	2	3.74	2.752	-	5.625	4.875	-	4.245	1-8

(1) Add B for coolant through the flange.

- These tool holders can be used only on vertical machines with an umbrella type ATC.
(They cannot be used with arm type ATC.)
- Applicable for 7 MPa pressure coolant.

Reference pages



Lock Screw

F123

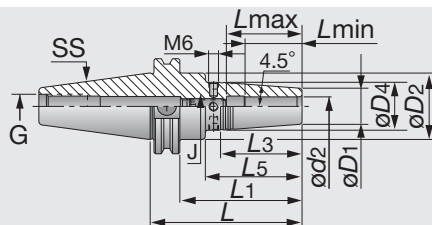

Inch	SS	ød2	øD1	øD2	øD4	L	L1	L3	L5	Lmin	Lmax	J	G	Hex Key
CAT40 SRKIN 1/4X3.500	40	0.25	0.827	1.752	1.063	3.5	2.75	1.501	2.12	0.98	1.42	M5	5/8-11	0.098
CAT40 SRKIN 5/16X3.500	40	0.313	0.827	1.752	1.063	3.5	2.75	1.501	2.12	0.98	1.42	M6	5/8-11	0.118
CAT40 SRKIN 3/8 X3.750	40	0.375	0.945	1.752	1.26	3.75	3	2	2.37	1.22	1.65	M8	5/8-11	0.157
CAT40 SRKIN 7/16X3.750	40	0.438	0.945	1.752	1.26	3.75	3	2.001	2.37	1.42	1.85	M10	5/8-11	0.197
CAT40 SRKIN 1/2 X3.750	40	0.5	0.945	1.752	1.26	3.75	3	2.001	2.37	1.42	1.85	M10	5/8-11	0.197
CAT40 SRKIN 5/8 X3.750	40	0.625	1.063	1.752	1.339	3.75	3	1.751	2.37	1.54	1.97	M12	5/8-11	0.236
CAT40 SRKIN 3/4 X4.000	40	0.75	1.299	1.752	1.654	4	3.25	2.251	2.62	1.61	2.05	M16	5/8-11	0.315
CAT40 SRKIN 7/8 X4.000	40	0.875	1.732	1.752	2.087	4	3.25	2.251	2.62	1.61	2.05	M16	5/8-11	0.315
CAT40 SRKIN 1 X4.000	40	1	1.732	1.752	2.087	4	3.25	2.251	2.62	1.85	2.28	M16	5/8-11	0.315
CAT40 SRKIN 1-1/4 X4.000	40	1.25	1.732	1.752	2.087	4	3.25	2.251	2.62	1.85	2.28	M16	5/8-11	0.315
CAT50 SRKIN 1/4 X3.500 ⁽¹⁾	50	0.25	0.827	2.752	1.063	3.5	2.75	1.501	2.12	0.98	1.42	M5	1-8	0.098
CAT50 SRKIN 5/16X3.500 ⁽¹⁾	50	0.313	0.827	2.752	1.063	3.5	2.7	1.501	2.12	0.98	1.42	M6	1-8	0.118
CAT50 SRKIN 3/8 X3.750 ⁽¹⁾	50	0.375	0.945	2.752	1.26	3.75	3	2	2.37	1.22	1.65	M8	1-8	0.157
CAT50 SRKIN 7/16X3.750 ⁽¹⁾	50	0.438	0.945	2.752	1.26	3.75	3	2.001	2.37	1.42	1.85	M10	1-8	0.197
CAT50 SRKIN 1/2 X3.750 ⁽¹⁾	50	0.5	0.945	2.752	1.26	3.75	3	2.001	2.37	1.42	1.85	M10	1-8	0.197
CAT50 SRKIN 5/8 X3.750 ⁽¹⁾	50	0.625	1.063	2.752	1.339	3.75	3	1.751	2.62	1.54	1.97	M12	1-8	0.236
CAT50 SRKIN 3/4 X4.000 ⁽¹⁾	50	0.75	1.299	2.752	1.654	4	3.25	2.251	2.62	1.61	2.05	M16	1-8	0.315
CAT50 SRKIN 7/8 X4.000 ⁽¹⁾	50	0.875	1.732	2.752	2.087	4	3.25	2.251	2.62	1.61	2.05	M16	1-8	0.315
CAT50 SRKIN 1 X4.000 ⁽¹⁾	50	1	1.732	2.752	2.087	4	3.25	2.251	2.62	1.85	2.28	M16	1-8	0.315
CAT50 SRKIN 1-1/4 X4.000 ⁽¹⁾	50	1.25	1.732	2.752	2.087	4	3.25	2.251	2.62	1.85	2.28	M16	1-8	0.315

(1) Balanced to G2.5 20.000 min-1

- Use only inductive heating device for SRKIN holders.
- Add B for coolant through the flange.
- Applicable for 10 MPa pressure coolant.

Reference pages

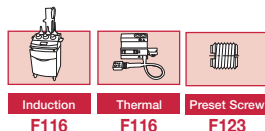



TungShrink thermal shrinking holder for carbide shank with CAT shank

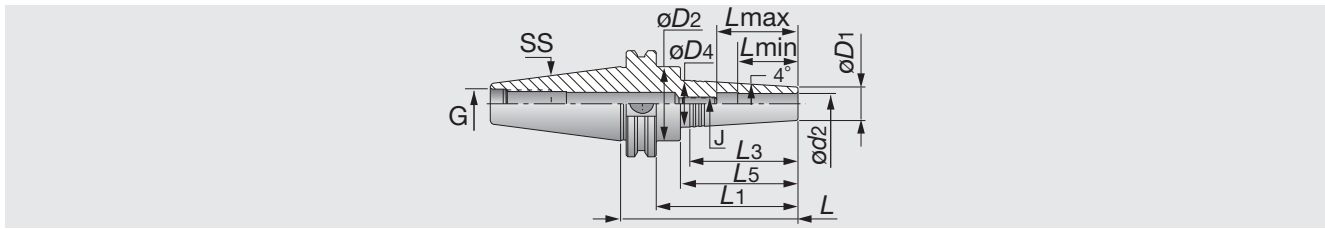

Inch	SS	ød2	øD1	øD2	øD4	L	L1	L3	L5	Lmin	Lmax	J	G	Hex Key
CAT40 SRK 1/8 X2.000	40	0.125	0.394	1.752	0.591	3.38	2.63	1.4	2	0.39	0.63	M6	5/8-11	0.118
CAT40 SRK 1/8 X3.250	40	0.125	0.394	1.752	0.748	4.63	2.88	2.526	3.25	0.39	0.63	M6	5/8-11	0.118
CAT40 SRK 3/16X2.000	40	0.188	0.394	1.752	0.591	3.38	2.63	1.4	2	0.59	0.83	M6	5/8-11	0.118
CAT40 SRK 3/16X3.250	40	0.188	0.394	1.752	0.748	4.963	2.88	2.526	3.25	0.59	0.83	M6	5/8-11	0.118
CAT40 SRK 1/4 X2.000	40	0.25	0.433	1.752	0.63	3.38	2.63	1.398	2	0.71	0.95	M8	5/8-11	0.157
CAT40 SRK 1/4 X3.250	40	0.25	0.433	1.752	0.787	4.63	2.88	2.524	3.25	0.71	0.95	M8	5/8-11	0.157
CAT40 SRK 5/16X2.000	40	0.313	0.551	1.752	0.787	3.38	2.63	1.673	2	0.98	1.22	M10	5/8-11	0.197
CAT40 SRK 5/16X3.250	40	0.313	0.551	1.752	0.906	4.63	2.88	2.518	3.25	0.98	1.22	M10	5/8-11	0.197
CAT40 SRK 3/8 X2.000	40	0.375	0.63	1.752	0.866	3.38	2.63	1.669	2	1.18	1.42	M12	5/8-11	0.236
CAT40 SRK 3/8 X3.250	40	0.375	0.63	1.752	0.965	4.63	2.88	2.373	3.25	1.18	1.42	M12	5/8-11	0.236
CAT40 SRK 7/16X2.000	40	0.438	0.787	1.752	1.024	3.38	2.63	1.665	2	1.22	1.61	M10	5/8-11	0.197
CAT40 SRK 7/16X3.250	40	0.438	0.787	1.752	1.102	4.63	2.88	2.228	3.25	1.22	1.61	M10	5/8-11	0.197
CAT40 SRK 1/2 X2.000	40	0.5	0.787	1.752	1.024	3.38	2.63	1.665	2	1.26	1.65	M10	5/8-11	0.197
CAT40 SRK 1/2 X3.250	40	0.5	0.787	1.752	1.102	4.63	3.25	2.228	3.25	1.26	1.65	M10	5/8-11	0.197

- Applicable for 10 MPa pressure coolant.

Reference pages

Induction
F116Thermal
F116Preset Screw
F123

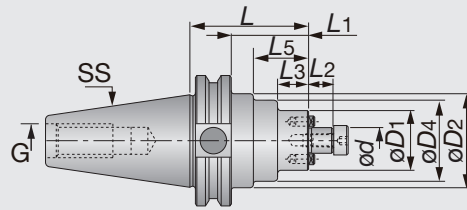

Inch	SS	ød	øD1	øD2	øD4	L	L1	L2	L3	L5	G
CAT40 SEM 1/2X1.500	40	0.5	-	1.75	1.378	1.5	0.57	0.75	-	0.102	5/8-11
CAT40 SEM 3/4X1.375	40	0.75	-	1.752	-	1.375	0.669	0.625	-	-	5/8-11
CAT40 SEM 1X2.062	40	1	-	1.752	2.165	2.062	0.669	1.312	-	0.682	5/8-11
CAT40 SEM 1-1/4X2.125	40	1.25	-	1.752	2.752	2.125	0.669	1.375	-	0.745	5/8-11
CAT40 SEM 1-1/2X2.406	40	1.5	-	1.752	3.071	2.406	0.938	1.656	-	1.026	5/8-11
CAT50 SEM 3/4X1.500	50	0.75	-	2.752	1.772	1.5	0.669	0.75	-	0.12	1-8
CAT50 SEM 3/4X1.920X8.00	50	0.75	-	2.752	1.92	8	0.669	7.25	-	6.583	1-8
CAT50 SEM 3/4X3.500	50	0.75	-	2.752	1.772	3.5	0.669	0.75	-	2.102	1-8
CAT50 SEM 3/4X5.500	50	0.75	1.772	2.752	2.362	5.5	0.669	4.75	2.48	4.13	1-8
CAT50 SEM 1X2.000	50	1	-	2.752	2.165	2	0.669	1.25	-	0.62	1-8
CAT50 SEM 1X2.42X12.00	50	1	-	2.752	2.42	12	0.669	11.25	-	10.583	1-8
CAT50 SEM 1X4.000	50	1	-	2.752	2.165	4	0.669	3.25	-	0.728	1-8
CAT50 SEM 1X6.000	50	1	-	2.752	2.165	6	0.669	5.25	-	2.657	1-8
CAT50 SEM 1-1/4X1.500	50	1.25	-	1.752	-	1.5	0.669	0.75	-	-	1-8
CAT50 SEM 1-1/4X2.92X13.0	50	1.25	-	2.752	2.921	13	0.669	12.25	-	11.62	1-8
CAT50 SEM 1-1/4X3.500	50	1.25	-	2.752	-	3.5	0.669	2.75	-	-	1-8
CAT50 SEM1-1/4X4.000	50	1.25	-	2.752	-	4	0.669	-	-	-	1-8
CAT50 SEM1-1/4X6.000	50	1.25	-	2.752	-	6	0.669	-	-	-	1-8
CAT50 SEM 1-1/2X2.406	50	1.5	-	2.752	3.071	2.406	0.938	1.656	-	1.026	1-8
CAT50 SEM 1-1/2X4.000	50	1.5	-	2.752	3.071	4	0.938	3.25	-	2.62	1-8
CAT50 SEM 1-1/2X6.000	50	1.5	-	2.752	3.071	6	0.938	5.25	-	4.62	1-8
CAT50 SEM 2X2.406	50	2	-	2.752	3.858	2.406	0.938	1.656	-	1.026	1-8
CAT50 SEM 2X4.000	50	2	-	2.752	3.858	4	0.938	3.25	-	2.62	1-8

- CAT40 = Balanced to G2.5 20,000 min-1
- CAT50 = Balanced to G2.5 15,000 min-1

Reference pages



Clamping screw
F122



Wrench
F124



TUNGHOLD

CAT-SEM-C (with coolant hole)

Shell mill holder with coolant hole for CAT shank

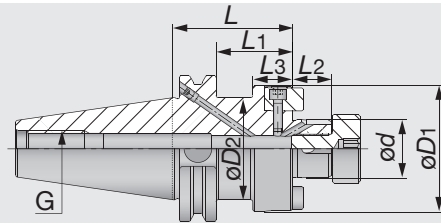

Inch	SS	ød	øD1	øD2	L	L1	L2	L3	G
CAT40 SEM 1/2X2.000 C	40	0.5	1.475	1.752	2	1.25	0.57	-	5/8-11
CAT40 SEM 3/4X 1.375 C	40	0.75	-	1.752	1.375	0.625	0.669	-	5/8-11
CAT40 SEM 1X 2.062 C	40	1	2.165	1.752	2.062	1.312	0.669	0.682	5/8-11
CAT40 SEM 1-1/4X2.125 C	40	1.25	2.752	1.752	2.125	1.375	0.669	0.745	5/8-11
CAT40 SEM 1-1/2X2.406 C	40	1.5	3.071	1.752	2.406	1.656	0.937	1.026	5/8-11
CAT50 SEM 1/2X 3.500 C	50	0.5	1.475	2.752	3.5	2.75	0.57	-	1-8
CAT50 SEM 3/4X 2.000 C	50	0.75	1.772	2.752	2	1.25	0.669	0.62	1-8
CAT50 SEM 3/4X 3.500 C	50	0.75	1.772	2.752	3.5	2.75	0.669	2.12	1-8
CAT50 SEM 3/4X 5.500 C	50	0.75	1.772	2.752	5.5	4.75	0.669	4.12	1-8
CAT50 SEM 1X 2.000 C	50	1	2.165	2.752	2	1.25	0.669	0.62	1-8
CAT50 SEM 1X 4.000 C	50	1	2.165	2.752	4	3.25	0.669	2.62	1-8
CAT50 SEM 1-1/4X2.000 C	50	1.25	-	2.752	2	1.25	0.669	0.62	1-8
CAT50 SEM 1-1/4X3.500 C	50	1.25	-	2.752	3.5	2.75	0.669	2.12	1-8
CAT50 SEM 1-1/2X2.500 C	50	1.5	3.071	2.752	2.5	1.75	0.937	1.12	1-8
CAT50 SEM 1-1/2X4.000 C	50	1.5	3.071	2.752	4	3.25	0.937	2.62	1-8

- CAT40 = Balanced to G2.5 20,000 min-1
- CAT50 = Balanced to G2.5 15,000 min-1
- Applicable for 7 MPa pressure coolant.

Reference pages



Clamping
screw
F122



Wrench
F124

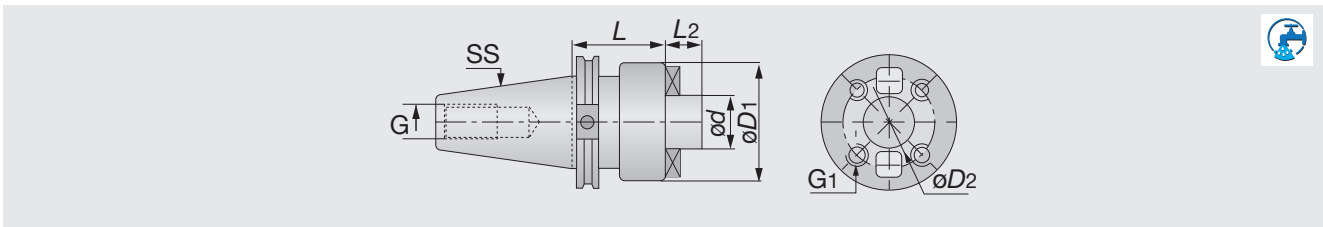

Inch	SS	ød	øD1	øD2	L	L2	G	G1
CAT50 FM 2-1/2X2.875	50	4.881	4	2.875	1.125	1-8	5/8-11	1.299

BT50-FM (Shell mill holder for long overhang)

Face mill holder with BT shank

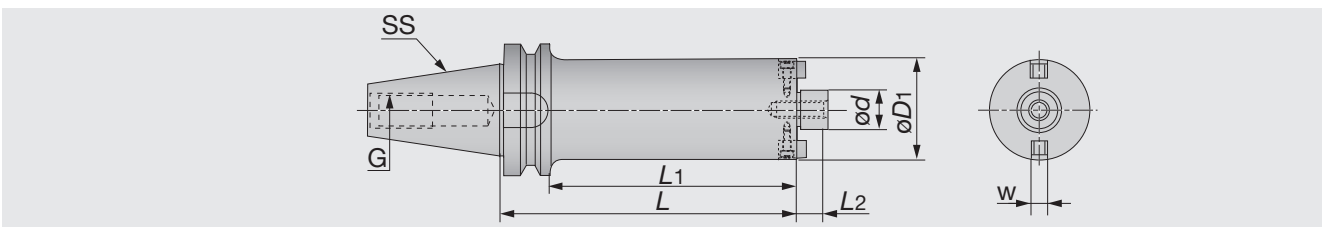

Metric	SS	ød	øD1	L2	L	L1	G	W	Kg
BT50-FMC22-138-47	50	22	47	18	138	100	M24	10	5.2
BT50-FMC22-188-47	50	22	47	18	188	150	M24	10	5.9
BT50-FMC22-243-47	50	22	47	18	243	205	M24	10	6.5
BT50-FMC22-293-47	50	22	47	18	293	255	M24	10	7.2
BT50-FMC22-178-59	50	22	59	18	178	140	M24	10	6.8
BT50-FMC22-238-59	50	22	59	18	238	200	M24	10	8
BT50-FMC22-308-59	50	22	59	18	308	270	M24	10	9.5
BT50-FMC22-373-59	50	22	59	18	373	335	M24	10	10.9
BT50-FMA31.75-215-76	50	31.75	76	30	215	177	M24	12.7	10
BT50-FMA31.75-295-76	50	31.75	76	30	295	257	M24	12.7	12.9
BT50-FMA31.75-375-76	50	31.75	76	30	375	337	M24	12.7	15.8
BT50-FMA31.75-275-96	50	31.75	96	30	275	237	M24	12.7	16.8
BT50-FMA31.75-375-96	50	31.75	96	30	375	337	M24	12.7	23

(Option:Wrench for lock screw)

Reference pages



Clamping screw
F122



Wrench
F124



TUNGHOLD

BT-SEMC (Combination holder for slot mill & shell mill)

Combination holder with BT shank

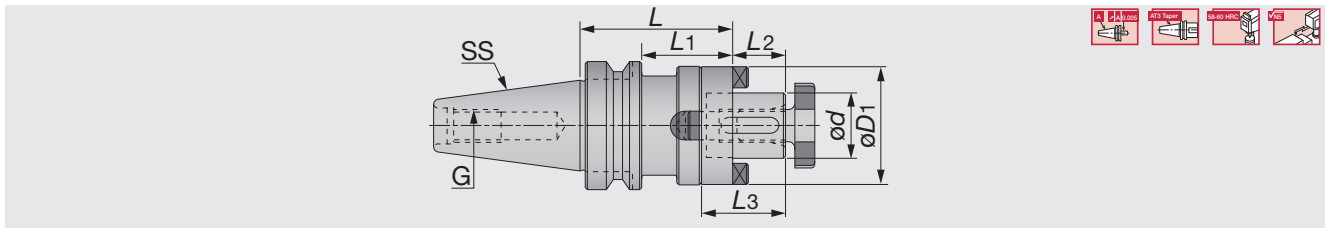

Metric	SS	ød	L2	øD1	L	L1	L3	G
BT40SEMC16X50	40	16	17	32	50	23	27	M16
BT40SEMC16X100	40	16	17	32	100	73	27	M16
BT40SEMC22X53	40	22	19	40	53	26	31	M16
BT40SEMC22X100	40	22	19	40	100	73	31	M16
BT40SEMC27X55	40	27	21	48	55	28	33	M16
BT40SEMC27X100	40	27	21	48	100	73	33	M16
BT40SEMC32X60	40	32	24	58	60	33	38	M16
BT40SEMC32X100	40	32	24	58	100	73	38	M16
BT40SEMC40X80	40	40	27	70	80	53	41	M16
BT50SEMC16X100	50	16	17	32	100	62	27	M24
BT50SEMC16X150	50	16	17	32	150	112	27	M24
BT50SEMC22X68	50	22	19	40	68	30	31	M24
BT50SEMC22X100	50	22	19	40	100	62	31	M24
BT50SEMC22X150	50	22	19	40	150	112	31	M24
BT50SEMC27X78	50	27	21	48	78	40	33	M24
BT50SEMC27X100	50	27	21	48	100	62	33	M24
BT50SEMC27X150	50	27	21	48	150	112	33	M24
BT50SEMC32X78	50	32	24	58	78	40	38	M24
BT50SEMC32X100	50	32	24	58	100	62	38	M24
BT50SEMC32X150	50	32	24	58	150	112	38	M24
BT50SEMC40X78	50	40	27	70	78	40	41	M24
BT50SEMC40X100	50	40	27	70	100	62	41	M24
BT50SEMC40X150	50	40	27	70	150	112	41	M24
BT50SEMC50X79	50	50	30	90	79	41	46	M24
BT50SEMC50X150	50	50	30	90	150	112	46	M24

(Option: Wrench for lock screw)

Reference pages



Clamping screw
F122



Wrench
F124

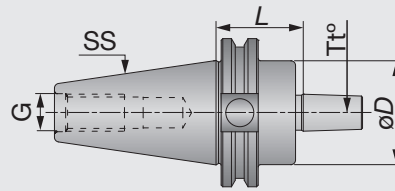

Inch	SS	Tt°	L	øD	G
CAT40 DC J2X1.500	40	J2	1.5	1.752	5/8-11
CAT40 DC J3X1.500	40	J3	1.5	1.75	5/8-11
CAT40 DC J4X1.500	40	J4	1.5	1.752	5/8-11
CAT40 DC J6X1.500	40	J6	1.5	1.752	5/8-11
CAT40 DC J33X1.500	40	J33	1.5	1.752	5/8-11
CAT50 DC J3 X1.656	50	J3	1.656	2.752	1-8
CAT50 DC J4 X1.500	50	J4	1.5	2.752	1-8
CAT50 DC J5 X1.625	50	J5	1.625	2.752	1-8
CAT50 DC J6 X1.500	50	J6	1.5	2.752	1-8
CAT50 D.CHK J33X1.500	50	J33	1.5	2.752	1-8

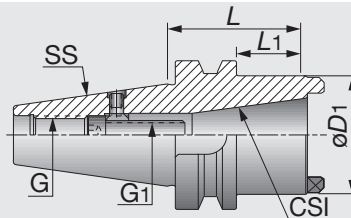

Metric	SS	CSI	L	øD1	L1	G1	G
BT50ADBT/SK40	50	DIN69871/A, BT MAS - 403	75	37	66	M16	M24
BT50AD40	50	DIN2080	70	32	63	M16	M24



TUNGSHOLD

CAT-MT (Morse taper)

Morse taper holder with CAT shank

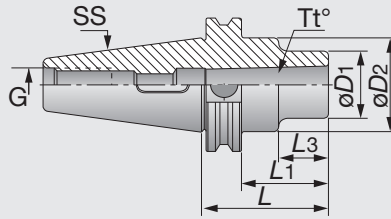

Inch	SS	L	L1	L3	øD1	øD2	G	Tt°
CAT40 MT 1X1.750	40	1.75	1	0.37	1	1.752	5/8-11	MT1
CAT40 MT 2X2.250	40	2.25	1.5	0.87	1.26	1.752	5/8-11	MT2
CAT40 MT 3X2.765	40	2.765	2.015	-	-	1.752	5/8-11	MT3
CAT40 MT 4X3.625	40	3.625	2.875	2.245	2.008	1.752	5/8-11	MT4
CAT50 MT 1X1.500	50	1.5	0.75	0.12	1	2.752	1-8	MT1
CAT50 MT 2X2.000	50	2	1.25	0.62	1.26	2.752	1-8	MT2
CAT50 MT 3X2.500	50	2.5	1.75	1.12	1.575	2.752	1-8	MT3
CAT50 MT 4X3.375	50	3.375	2.625	1.995	1.969	2.752	1-8	MT4
CAT50 MT 5X3.750	50	3.75	3	-	-	2.752	1-8	MT5

TUNGSHOLD

BT-MT DRW (Holder with draw bar)

Morse taper holder with draw bar type for BT shank

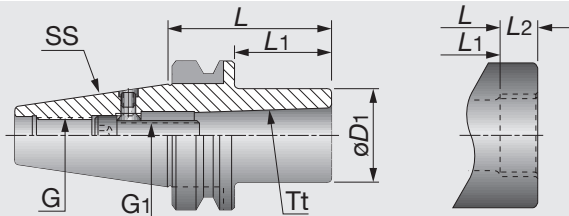

Metric	SS	Tt	L	L1	L2	øD1	G1	G
BT40MT1DRW	40	MT1	50	23	-	25	M6	M16
BT40MT2DRW	40	MT2	50	23	-	32	M10	M16
BT40MT3DRW	40	MT3	70	43	-	40	M12	M16
BT40MT4DRW ⁽¹⁾	40	MT4	95	68	15	63	M16	M16
BT50MT1DRW	50	MT1	45	7	-	25	M6	M24
BT50MT2DRW	50	MT2	60	22	-	32	M10	M24
BT50MT3DRW	50	MT3	65	27	-	40	M12	M24
BT50MT4DRW ⁽¹⁾	50	MT4	70	32	15	63	M16	M24
BT50MT5DRW ⁽¹⁾	50	MT5	100	62	18	78	M20	M24

(1) DIN2201.

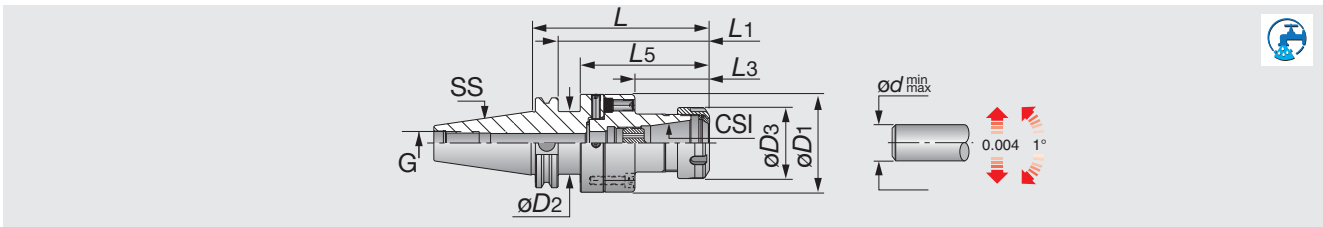

Inch	SS	ødmin	ødmax	L	L1	L3	L5	øD1	øD2	øD3	G
ADJ CAT40 D2.756 ER32	40	0.08	0.789	4.902	4.152	2.067	3.522	2.756	1.752	1.969	5/8-11
ADJ CAT50 D2.756 ER32	50	0.08	0.789	4.902	4.152	2.067	-	2.756	-	1.969	1-8

• Applicable for 10 MPa pressure coolant.

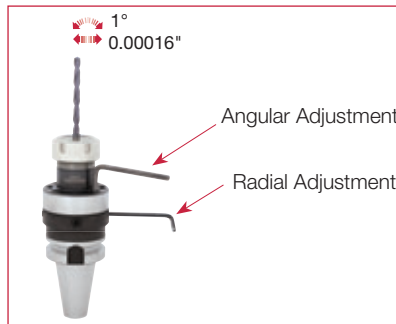

Reference pages



ER Collet
F099



Nut
F118



Wrench
F120



Preset Screw
F121

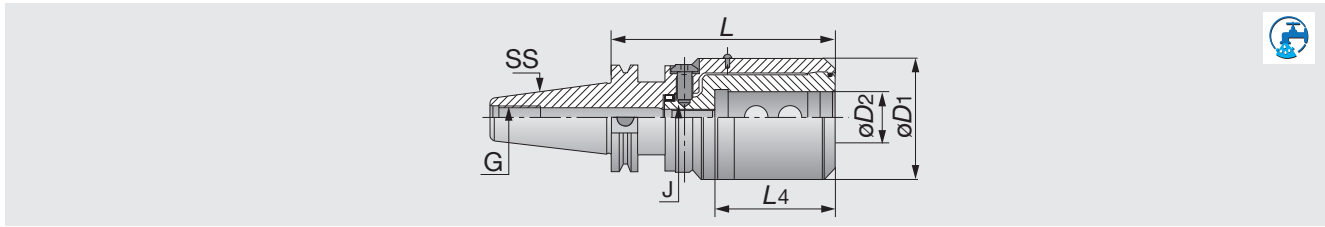

Inch	SS	ϕD_1	ϕD_2	L	L4	J	G
TUNGBORE CAT40 EM3/4	40	2.835	0.75	5.337	2.795	M10	5/8-11
TUNGBORE CAT40 EM3/4 B	40	2.835	0.75	5.337	2.795	M10	5/8-11
TUNGBORE CAT40 EM1	40	2.835	1	5.337	2.795	M10	5/8-11
TUNGBORE CAT40 EM1 B	40	2.835	1	5.337	2.795	M10	5/8-11
TUNGBORE CAT40 EM1-1/4	40	2.835	1.25	5.337	2.795	M10	5/8-11
TUNGBORE CAT40 EM1-1/4 B	40	2.835	1.25	5.337	2.795	M10	5/8-11
TUNGBORE CAT40 EM1-1/2	40	2.835	1.5	5.337	2.795	M10	5/8-11
TUNGBORE CAT40 EM1-1/2 B	40	2.835	1.5	5.337	2.795	M10	5/8-11
TUNGBORE CAT50 EM3/4	50	2.835	0.75	5.179	2.795	M10	1-8
TUNGBORE CAT50 EM1	50	2.835	1	5.179	2.795	M10	1-8
TUNGBORE CAT50 EM1 B	50	2.835	1	5.179	2.795	M10	1-8
TUNGBORE CAT50 EM1-1/4	50	2.835	1.25	5.179	2.795	M10	1-8
TUNGBORE CAT50 EM1-1/4 B	50	2.835	1.25	5.179	2.795	M10	1-8
TUNGBORE CAT50 EM1-1/2	50	2.835	1.5	5.179	2.795	M10	1-8
TUNGBORE CAT50 EM1-1/2 B	50	2.835	1.5	5.179	2.795	M10	1-8

• Applicable for 10 MPa pressure coolant.

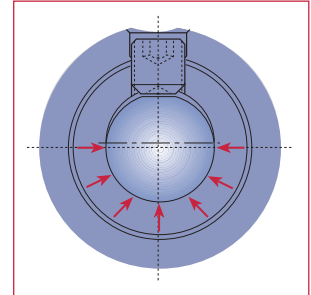
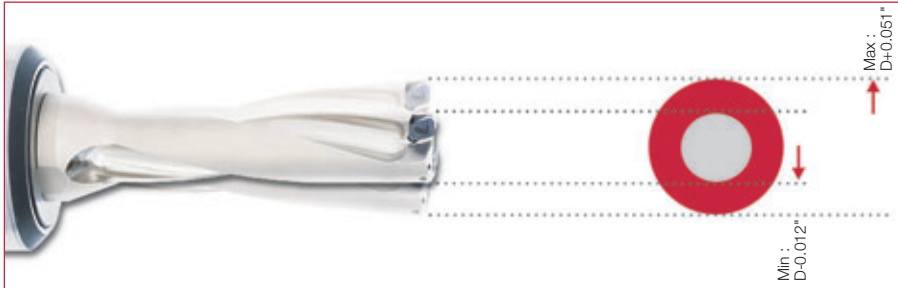

The bore's section is actually made from two shifted circular sections. The clamping screw pushes the drill shank through a narrowed opening, forcing elastic deformation of the holder. Contact is made around more than 180°, providing a high clamping force.

TUNG^{GTI}

GTI-CAT (Tapping holder)

TungGTI tapping attachment with CAT shank



Tooling System

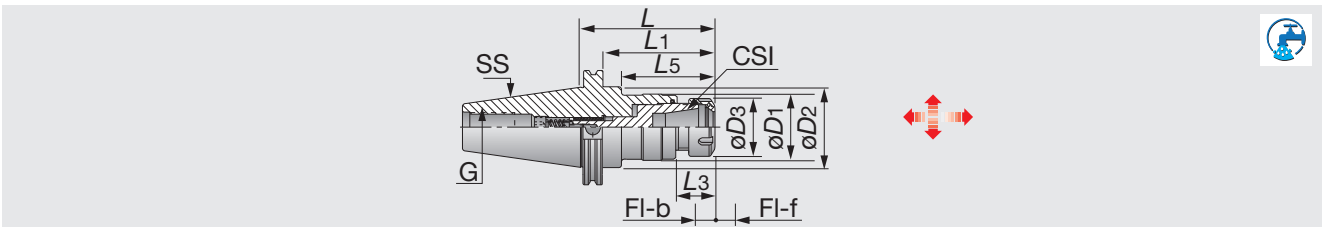

Inch	SS	CSI	Tap min	Tap max	L	L1	L5	L3	øD3	øD1	øD2	FI-f	FI-b	G
GTI CAT40 ER16	40	ER16	#6	3/8	3.203	2.453	1.823	0.969	1.102	1.161	1.752	0.32	0.12	5/8-11
GTI CAT40 ER32	40	ER32	1/4	3/4	4.439	3.689	3.059	1.299	1.969	2.224	1.752	0.36	0.16	5/8-11
GTI CAT40 ER40	40	ER40	1/4	1-1/8	5.148	4.398	3.768	2.008	2.480	2.224	1.752	0.36	0.16	5/8-11
GTI CAT50 ER16	50	ER16	#6	3/8	4.213	3.463	2.833	0.969	1.102	1.161	2.752	0.32	0.12	1-8
GTI CAT50 ER32	50	ER32	1/4	3/4	4.543	3.793	3.163	1.299	1.969	2.224	2.752	0.36	0.16	1-8
GTI CAT50 ER40	50	ER40	1/4	1-1/8	5.252	4.502	3.872	2.008	2.480	2.224	2.752	0.36	0.16	1-8

• Applicable for 10 MPa pressure coolant.

TUNG^{FIT}

CAT-CF (Quick change holder)

TungFit quick change style modular tooling system with CAT shank

TUNGHOLD

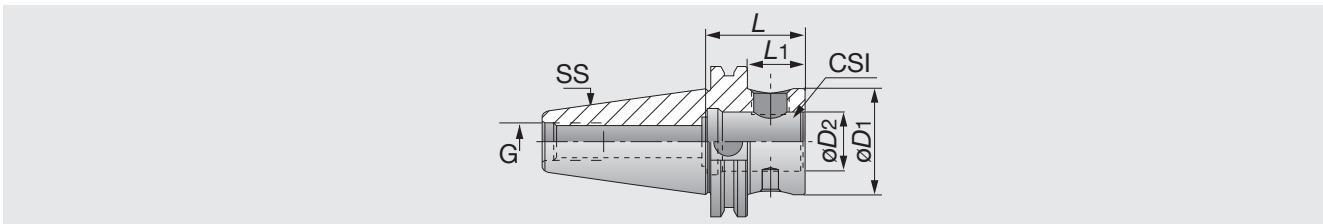

Inch	SS	CSI	L	L1	øD2	øD1	G
CAT40 CF4-L	40	CF4	4.000	3.252	0.984	1.752	5/8-11
CAT40 CF4-S	40	CF4	1.750	1.000	0.984	1.752	5/8-11
CAT50 CF4-L	50	CF4	4.000	3.252	0.984	1.752	1-8
CAT50 CF4-S	50	CF4	1.750	1.000	0.984	1.752	1-8

- Tightening torque: 43.4 lb-ft
- Add B for coolant through the flange.
- Applicable for 10 MPa pressure coolant.

Reference pages



ER Collet
F099



Nut
F118



Wrench
F120



Preset Screw
F121

TUNGCLICK

CAT-CLICK

TungClick quick change tooling system with CAT shank

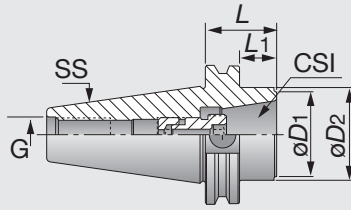

Inch	SS	CSI	L	L1	øD1	øD2	G
CAT40 ER32 CLICK-IN	40	32SRF	0.789	-	1.614	-	5/8X11
CAT50 ER32 CLICK-IN	50	32SRF	0.789	-	1.614	-	1-8
CAT50 ER32 CLICK-IN M	50	32SRF	1.419	0.669	1.614	2.752	1-8

- Tightening torque: 235 N-m
- Applicable for 10 MPa pressure coolant.

TUNGFLEX

CAT-ODP

TungFlex modular tooling system with CAT shank

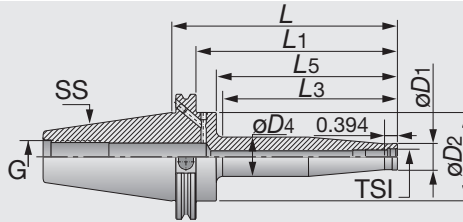

Inch	SS	TSI	øD1	øD2	øD4	L	L1	L3	L5	G
CAT40 ODP M 6X2.000	40	M6	0.380	-	0.511	2.000	0.935	0.935	-	5/8-11
CAT40 ODP M 6X4.000	40	M6	0.380	-	0.725	4.000	2.935	2.935	-	5/8-11
CAT40 ODP M 8X2.000	40	M8	0.510	-	0.580	2.000	0.944	0.944	-	5/8-11
CAT40 ODP M 8X4.000	40	M8	0.510	-	0.790	4.000	2.913	2.913	-	5/8-11
CAT40 ODP M10X2.000	40	M10	0.710	-	0.780	2.000	1.062	1.062	-	5/8-11
CAT40 ODP M10X4.000	40	M10	0.710	-	0.990	4.000	3.149	3.149	-	5/8-11
CAT40 ODP M12X4.000	40	M12	0.830	-	1.110	4.000	3.149	3.149	-	5/8-11
CAT40 ODP M12X6.000	40	M12	0.830	-	1.310	6.000	5.118	5.118	-	5/8-11
CAT40 ODP M16X4.000	40	M16	1.140	-	1.420	4.000	3.149	3.149	-	5/8-11
CAT40 ODP M16X6.000	40	M16	1.140	-	1.620	6.000	5.118	5.118	-	5/8-11
CAT50 ODP M 8X5.000 ⁽¹⁾	50	M8	0.516	2.752	0.906	5.000	4.232	3.405	3.602	1-8
CAT50 ODP M10X3.000 ⁽¹⁾	50	M10	0.709	2.752	0.693	3.000	2.232	1.405	1.602	1-8
CAT50 ODP M10X7.000 ⁽¹⁾	50	M10	0.709	2.752	1.102	7.000	6.232	5.405	5.602	1-8
CAT50 ODP M12X3.000 ⁽¹⁾	50	M12	0.827	2.752	0.811	3.000	2.232	1.405	1.602	1-8
CAT50 ODP M12X7.000 ⁽¹⁾	50	M12	0.827	2.752	1.220	7.000	6.232	5.405	5.602	1-8
CAT50 ODP M16X3.000 ⁽¹⁾	50	M16	1.142	2.752	1.126	3.000	2.232	1.405	1.602	1-8
CAT50 ODP M16X7.000 ⁽¹⁾	50	M16	1.142	2.752	1.339	7.000	6.232	5.405	5.602	1-8

- (1) Balanced to G2.5 12,000 min-1
- Applicable for 10 MPa pressure coolant.

Reference pages



ER 32 ODP
F113

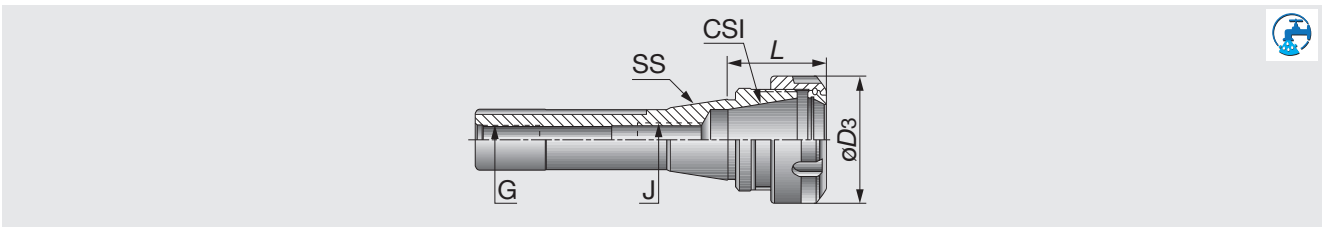

Metric	SS	CSI	Range	L	øD3	J	G
R-8ER16X38	R-8	ER16	0.5-10	38	28	M10	7/16-20
R-8ER32X40	R-8	ER32	2-20	40	50	M12	7/16-20
R-8ER40X72	R-8	ER40	3-26	72	63	M12	7/16-20

• Applicable for 10 MPa pressure coolant.

(Option:Wrench for ER collet)

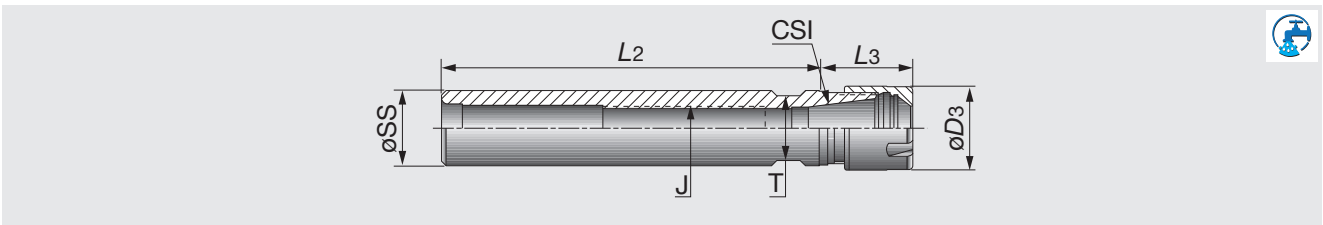

Metric	øSS	CSI	Range	L2	L3	J	øD3	T
ST12X80ER11M	12	ER11	0.5-7	80	26.5	-	16	11
ST16X50ER11MF	16	ER11	0.5-7	50	18.5	M8	16	13
ST16X100ER11M	16	ER11	0.5-7	100	18.5	M8	16	13
ST16X150ER11M	16	ER11	0.5-7	150	18.5	M8	16	13
ST12X80ER16M	12	ER16	0.5-10	80	36.5	-	22	17
ST20X100ER16M	20	ER16	0.5-10	100	25	M12	22	17
ST20X150ER16M	20	ER16	0.5-10	150	25	M12	22	17
ST20X100ER20M	20	ER20	1-13	100	40	M12	28	21
ST20X150ER20M	20	ER20	1-13	150	40	M12	28	21

• F indicates a flat on the shank.

• Applicable for 10 MPa pressure coolant.

(Option:Wrench for ER collet)



TUNGHOLD

ST-ER (Collet chuck)

ER collet chucks with Straight shank

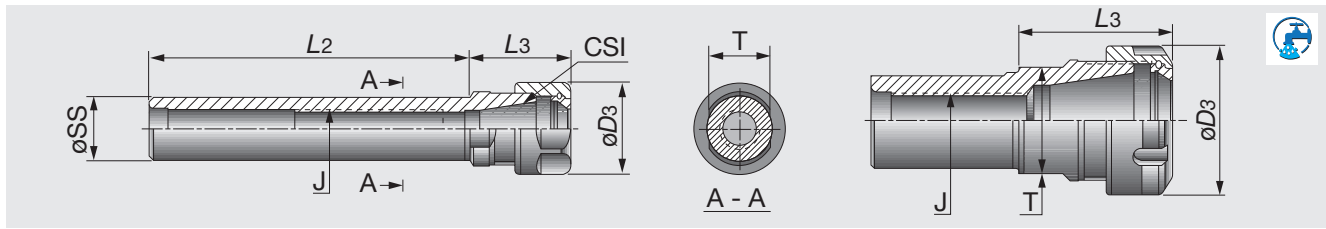

Metric	øSS	CSI	Range	L2	L3	J	øD3	T
ST16X50ER11F	16	ER11	0.5-7	50	18.5	M8	19	13
ST20X50ER11F	20	ER11	0.5-7	50	18.5	M10	19	17
ST20X100ER11	20	ER11	0.5-7	100	18.5	M10	19	17
ST20X150ER11	20	ER11	0.5-7	150	18.5	M10	19	17
ST20X50ER16F	20	ER16	0.5-10	50	32.3	M12	28	19
ST20X100ER16	20	ER16	0.5-10	100	30	M12	28	19
ST20X150ER16	20	ER16	0.5-10	150	30	M12	28	19
ST20X50ER20F	20	ER20	1-13	50	42.5	M12	34	22
ST25X100ER20	25	ER20	1-13	100	36	M16	34	22
ST25X150ER20	25	ER20	1-13	150	36	M16	34	22
ST20X50ER25F	20	ER25	1-16	50	46	M12	42	28
ST20X100ER25	20	ER25	1-16	100	46	M12	42	28
ST20X50ER32F	20	ER32	2-20	50	54	M12	50	36
ST20X100ER32	20	ER32	2-20	100	54	M12	50	36
ST25X50ER25F	25	ER25	1-16	50	46	M16	42	28
ST25X100ER25	25	ER25	1-16	100	46	M16	42	28
ST25X50ER32F	25	ER32	2-20	50	52	M16x2	50	36
ST25X50ER40F	25	ER40	3-26	50	60	M16x2	63	45
ST30X50ER32F	30	ER32	2-20	50	52	M18x1.5	50	36
ST30X50ER40F	30	ER40	3-26	50	60	M18x1.5	63	45
ST32X50ER32F	32	ER32	2-20	50	52	M18x1.5	50	36
ST32X150ER32	32	ER32	2-20	150	52	M18x1.5	50	36
ST32X50ER40F	32	ER40	3-26	50	60	M18x1.5	63	45
ST40X75ER32F	40	ER32	2-20	75	46	M22x1.5	50	44
ST40X75ER40F	40	ER40	3-26	75	55	M22x1.5	63	45
ST50X80ER40F	50	ER40	3-26	80	60	M28x1.5	63	54
ST50X80ER50F	50	ER50	10-34	80	77	M36x1.5	78	58

- F indicates a flat on the shank.
- Applicable for 10 MPa pressure coolant.

(Option: Wrench for ER collet)

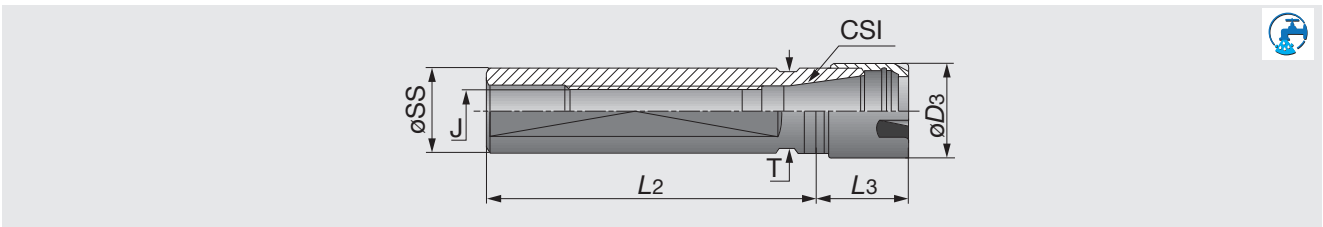

Metric	ϕSS	CSI	Range	L_2	L_3	J	ϕD_3	T	Machine
ST16X35ER16MF	16	ER16	0.5-10	35	36	M8X1	22	17	Star
ST16X38ER11MF	16	ER11	0.5-7	38	18.5	M8X1	16	14	Star
ST16X140ER11MF	16	ER11	0.5-7	140	18.5	M8X1	16	14	-
ST20X70ER16MF	20	ER16	0.5-10	70	26	M12X1	22	17	Citizen
ST20X120ER16MF	20	ER16	0.5-10	120	26	M12X1	22	17	Citizen
ST20X140ER16MF	20	ER16	0.5-10	140	26	M12X1	22	17	Citizen
ST22X38ER16MF	22	ER16	0.5-10	38	26	M12X1	22	19	Citizen
ST22X70ER16MF	22	ER16	0.5-10	70	26	M12X1	22	19	Star
ST22X70ER25MF	22	ER25	1-16	70	47	M12X1	35	27	Star
ST22X80ER20MF	22	ER20	1-13	80	39	M12X1	28	21	Star
ST22X100ER16MF	22	ER16	0.5-10	100	28	M12X1	22	19	Star
ST25X65ER16MF	25	ER16	0.5-10	65	28	M12X1	22	22	-
ST25X75ER25MF	25	ER25	1-16	75	48	M14X1	35	27	Manurhin
ST25X100ER20MF	25	ER20	1-13	100	28	M14X1	28	22	Tornos
ST25X145ER25MF	25	ER25	1-16	145	36	M14X1	35	27	Tornos
ST25X154ER20MF	25	ER20	1-13	154	28	M14X1	28	22	Tornos
ST32X70ER25MF	32	ER25	1-16	70	30	M18X1	35	27	Schuette

• Applicable for 10 MPa pressure coolant.

(Option = Wrench for ER collet)

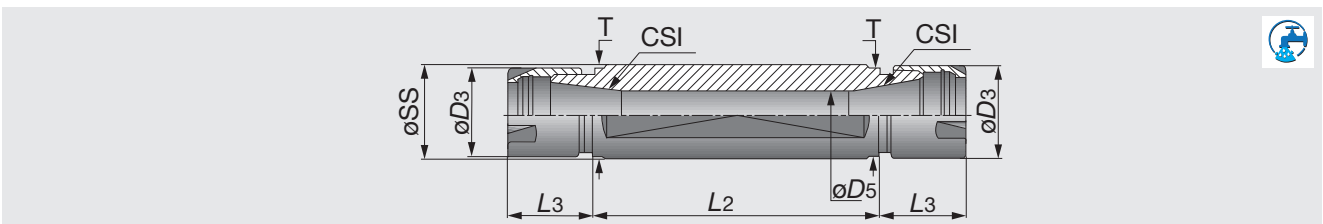

Metric	ϕSS	CSI	Range	L_2	L_3	ϕD_3	ϕD_5	T	Machine
ST16X50ER11MFD	16	ER11	0.5-7	50	18.5	16	7.5	14	-
ST20X30ER11MFD	20	ER11	0.5-7	30	18.5	16	7.5	17	Citizen
ST20X50ER11MFD	20	ER11	0.5-7	50	18.5	16	7.5	17	Citizen
ST20X55ER16MFD	20	ER16	0.5-10	55	25	22	10.5	17	Citizen
ST22X55ER16MFD	22	ER16	0.5-10	55	28	22	10.5	19	Star
ST22X75ER16MFD	22	ER16	0.5-10	75	28	22	10.5	19	Star
ST25X62ER16MFD	25	ER16	0.5-10	62	28	22	10.5	22	-
ST32X55ER20MFD	32	ER20	1-13	55	28	28	13.5	27	Star
ST32X75ER20MFD	32	ER20	1-13	75	28	28	13.5	27	Star

• Applicable for 10 MPa pressure coolant.

(Option = Wrench for ER collet)

TUNG HOLD

ST-ER-S

ER collet chucks with internal coolant

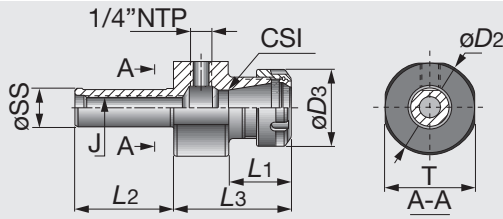

Metric	ϕSS	CSI	Range	L_2	L_3	L_1	J	ϕD_3	ϕD_2	T
ST20X65ER16S	20	ER16	0.5-10	65	54	29.6	M12	28	40	34
ST20X65ER20S	20	ER20	1-13	65	63	31	M12	34	40	34
ST20X65ER25S	20	ER25	1-16	65	72	32	M12	42	54	51
ST20X65ER32S	20	ER32	2-20	65	77	41	M12	50	63	59
ST25X65ER25S	25	ER25	1-16	65	72	32	M12	42	54	50
ST25X65ER32S	25	ER32	2-20	65	77	41	M16	50	63	59
ST32X65ER32S	32	ER32	2-20	65	77	41	M18x1.5	50	63	59
ST40X75ER32S	40	ER32	2-20	75	77	41	M22x1.5	50	63	59

• Applicable for 10 MPa pressure coolant.

(Option = Wrench for ER collet)

TUNGSHRINK

ST-SRK

TungShrink thermal shrinking holder for carbide shank with Straight shank

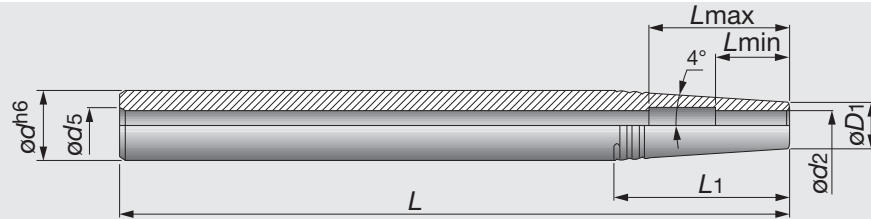

Inch	ϕd	ϕd_2	ϕd_1	ϕd_5	L	L_1	L_{min}	L_{max}
ST 1/2X6.30 SRK 1/8	0.5	0.125	0.394	0.157	6.3	0.76	0.39	-
ST 1/2X6.30 SRK 3/16	0.5	0.188	0.394	0.157	6.3	0.76	0.59	1.18
ST 5/8X6.30 SRK 1/8	0.625	0.125	0.394	0.236	6.3	1.374	0.39	-
ST 5/8X6.30 SRK 3/16	0.625	0.188	0.394	0.236	6.3	1.654	0.59	-
ST 5/8X6.30 SRK 1/4	0.625	0.25	0.433	0.236	6.3	1.374	0.71	1.38
ST 3/4X8.00 SRK 3/16	0.75	0.188	0.394	0.236	8	2.548	0.59	-
ST 3/4X8.00 SRK 1/4	0.75	0.25	0.433	0.236	8	2.267	0.71	1.38
ST 3/4X8.00 SRK 5/16	0.75	0.313	0.551	0.236	8	1.422	0.98	1.58
ST 1X8.000 SRK 1/4	1	0.25	0.433	0.315	8	4.053	0.71	1.38
ST 1X8.000 SRK 5/16	1	0.313	0.551	0.315	8	3.209	0.98	1.58
ST 1X8.000 SRK 3/8	1	0.375	0.63	0.315	8	2.646	1.18	1.77
ST 1X8.000 SRK 7/16	1	0.438	0.787	0.315	8	1.52	1.26	1.97
ST 1X8.000 SRK 1/2	1	0.5	0.787	0.315	8	1.52	1.26	1.97

• Applicable for 10 MPa pressure coolant.

(Option = Wrench for ER collet)

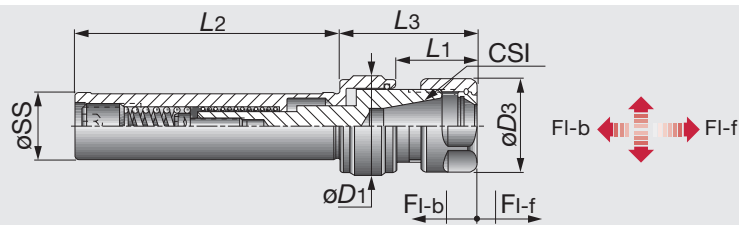

Metric	øSS	CSI	Tap min	Tap max	Range	øD3	øD1	L1	L3	L2	FI-f	FI-b
GTIER11ST16X150M	16	ER11	M2	M7	0.5-7	16	-	19	-	150	6	3
GTIER16ST20X80	20	ER16	M3	M10	0.5-10	28	29.5	24.6	41.6	80	8	3
GTIER20ST20X80	20	ER20	M4	M14	1-13	34	33.5	28	49	80	8	3
GTIER25ST25X80	25	ER25	M5	M16	1-16	42	40.5	32	53	80	9	4
GTIER32ST25X80	25	ER32	M6	M20	1-16	50	56.5	32	77.2	80	9	4
GTIER40ST32X80	32	ER40	M6	M27	2-20	63	56.5	51	95.2	80	9	4

(Option = Wrench for ER collet)

TUNG^{HOLD}

ADJ ST-ER

ER collet chuck with center alignment

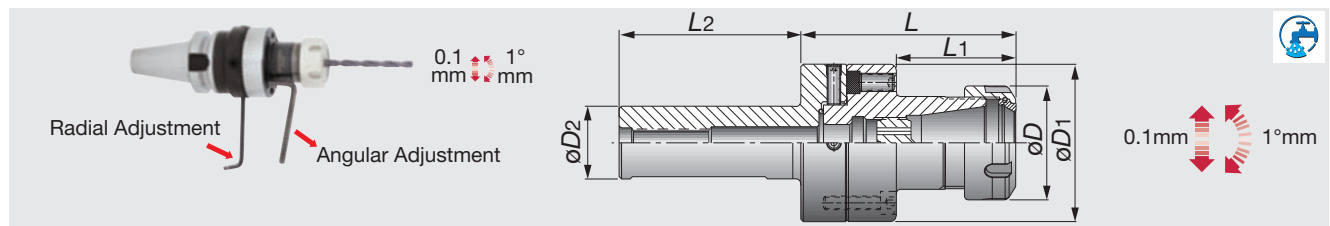

Metric	Range	L	L1	L2	øD	øD1	øD2
ADJST25D70ER32	2-20	94.5	52.5	80	50	70	25
ADJST32D70ER32	2-20	94.5	52.5	80	50	70	32

• Applicable for 10 MPa pressure coolant.

(Option = Wrench for ER collet)

TUNG^{HOLD}

MT-ER

ER collet chucks with morse taper

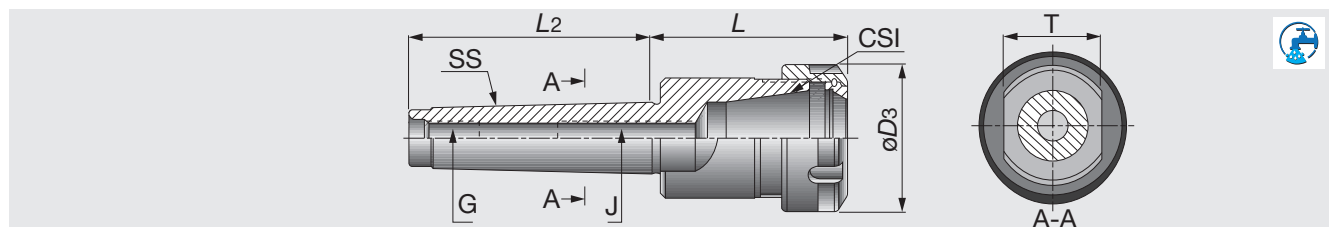

Metric	SS	CSI	Range	L	L2	øD3	J	G	T
MT2ER20X48.5	MT 2	ER20	1-13	48.5	64	34	M10	M10	22
MT2ER25X52	MT 2	ER25	1-16	52	64	42	M10	M10	28
MT3ER32X69	MT 3	ER32	2-20	69	81	50	M12	M12	24
MT3ER40X79	MT 3	ER40	3-26	79	81	63	M12	M12	24
MT4ER32X61	MT 4	ER32	2-20	60.5	102.5	50	M16	M16	32
MT4ER40X82	MT 4	ER40	3-26	81.5	102.5	63	M16	M16	32
MT4ER50X108	MT 4	ER50	10-34	107.5	102.5	78	M16	M16	32
MT5ER40X82	MT 5	ER40	3-26	82	129.5	63	M28x1.5	M20	45
MT5ER50X85	MT 5	ER50	10-34	85	129.5	78	M28x1.5	M20	45

• Applicable for 3 MPa pressure coolant.

(Option = Wrench for ER collet)

TUNGGYRO

GYRO ST-ER TUNGGYRO

Center alignment collet chuck holder for lathe

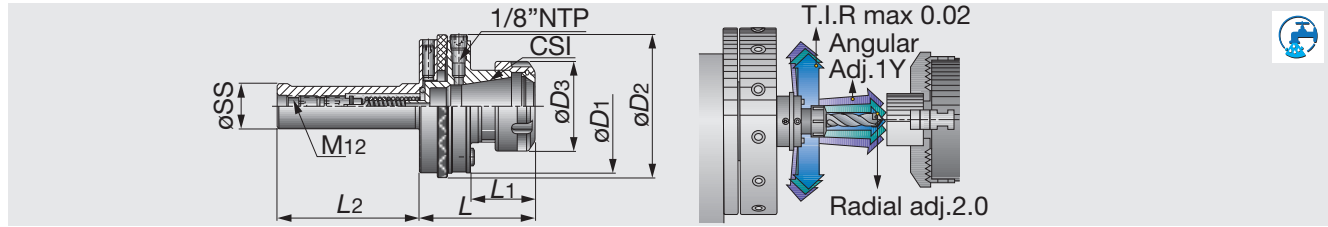

Metric	øSS	CSI	Range	L	L1	L2	øD3	øD1	øD2
GYROST20ER20	20	ER20	1-13	58.8	28.5	80	34	57	63
GYROST20ER25	20	ER25	1-16	58.8	28.5	80	34	57	63
GYROST25ER25	25	ER25	1-16	65.65	35.5	80	42	74	79
GYROST25ER32	25	ER32	2-20	66.65	36.5	80	50	74	79
GYROST32ER32	32	ER32	2-20	66.65	36.5	80	50	74	79
GYROST40ER32	40	ER32	2-20	66.65	36.5	80	50	74	79

- First-time users should buy a GYRO kit which includes a test bar and a bushing for performing the alignment procedure.
- Applicable for 3 MPa pressure coolant.

(Option = Wrench for ER collet)

TUNGGYRO

KIT GYRO-ST-ER

The Kit contains 1 center alignment collet chuck and a centering bushing

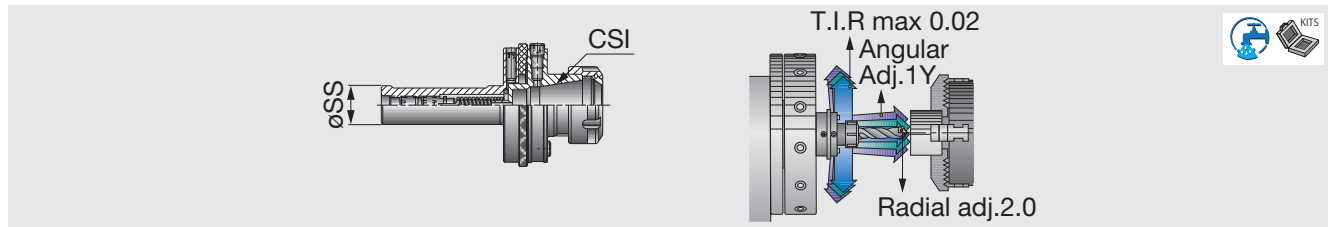

Metric	øSS	CSI	Range
KITGYROST20ER20	20	ER20	1-13
KITGYROST20ER25	20	ER25	1-16
KITGYROST25ER25	25	ER25	1-16
KITGYROST25ER32	25	ER32	2-20
KITGYROST32ER32	32	ER32	2-20
KITGYROST40ER32	40	ER32	2-20

- Kit includes: GYRO, test bar and bushing.
- Applicable for 3 MPa pressure coolant.

(Option = Wrench for ER collet)

TUNGGYRO

GYRO DIN69880-ER

Center alignment collet chuck holder for lathe

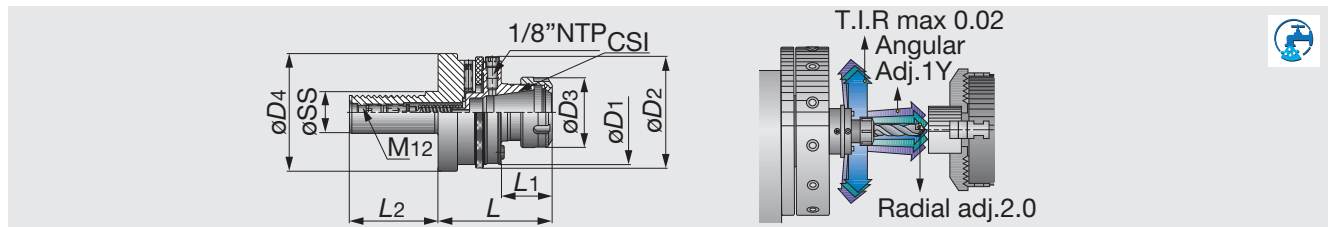

Metric	øSS	CSI	Range	L	L1	L2	øD3	øD1	øD2	øD4
GYRODIN6988030ER25	30	ER25	1-16	80.65	35.5	55	42	74	79	68
GYRODIN6988030ER32	30	ER32	2-20	81.65	36.5	55	50	74	79	68
GYRODIN6988040ER32	40	ER32	2-20	81.65	36.5	63	50	74	79	83.2
GYRODIN6988050ER32	50	ER32	2-20	81.65	36.5	78	50	74	79	98

- First-time users should buy a GYRO kit which includes a test bar and a bushing for performing the alignment procedure.
- Applicable for 3 MPa pressure coolant.

(Option = Wrench for ER collet)

TUNGGYRO

KIT GYRO-DIN69880-ER

The Kit contains 1 center alignment ER collet chuck with VDI DIN69880 shank and a centering bushing

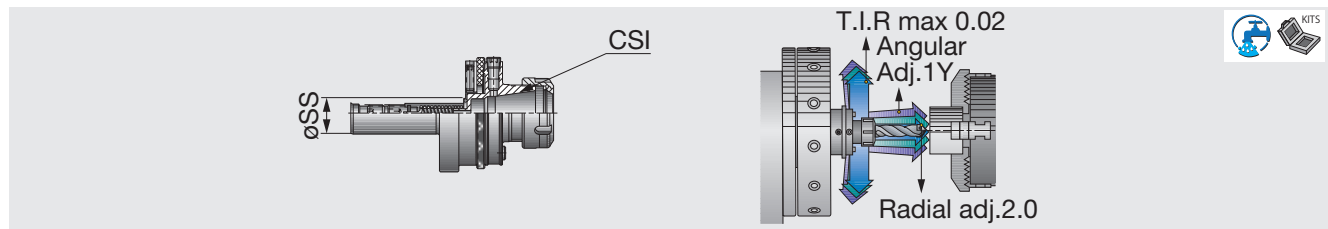

Metric	ϕSS	CSI	Range
KITGYRO30D69880ER25	30	ER25	1-16
KITGYRO30D69880ER32	30	ER32	2-20
KITGYRO40D69880ER32	40	ER32	2-20
KITGYRO50D69880ER32	50	ER32	2-20

- Kit includes: GYRO, test bar and bushing.
- Applicable for 3 MPa pressure coolant.

(Option = Wrench for ER collet)

TUNGGFI

GFI-MT-ER

Floating reamer collet chuck

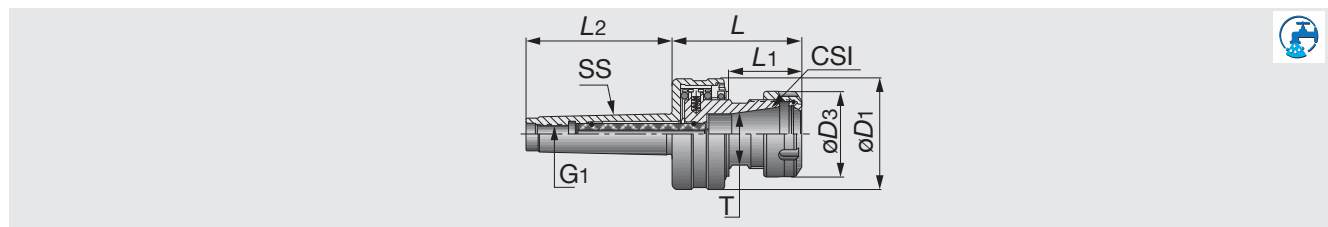

Metric	SS	CSI	Range	L2	L	L1	$\phi D3$	$\phi D1$	Radial Float	T	G1
GFIMT2ER20	MT 2	ER20	1-13	64	60.5	34.5	34	50	1	22	M10
GFIMT3ER32	MT 3	ER32	2-20	81	81.9	45.9	50	65	1.6	36	M12

- Maximum 2000 min⁻¹.
- Applicable for 3 MPa pressure coolant.

(Option = Wrench for ER collet)

TUNGGFI

GFI-ST-ER

Floating reamer collet chuck

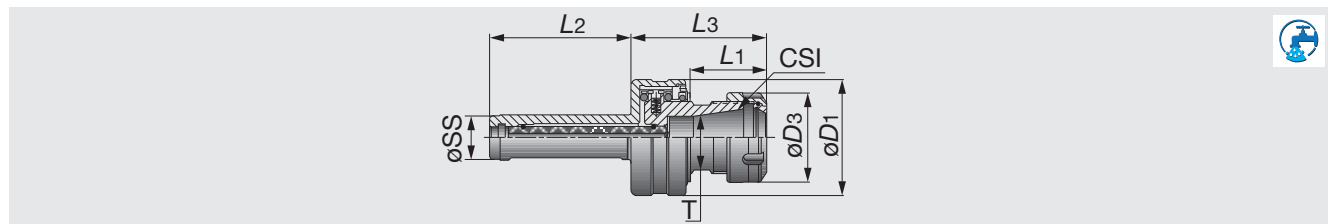

Metric	ϕSS	CSI	Range	L2	L3	L1	$\phi D3$	$\phi D1$	Radial Float	T
GFIST20ER20	20	ER20	1-13	65	55.5	34.5	34	50	1	22
GFIST25ER32	25	ER32	2-20	80	76.9	45.9	50	65	1.6	36

- Maximum 2000 min⁻¹.
- Applicable for 3 MPa pressure coolant.

(Option = Wrench for ER collet)

TUNGFLEX

S M TungFlex-straight shank

TungFlex modular tooling system with straight shank (Screw clamp holder for modular cutting heads)

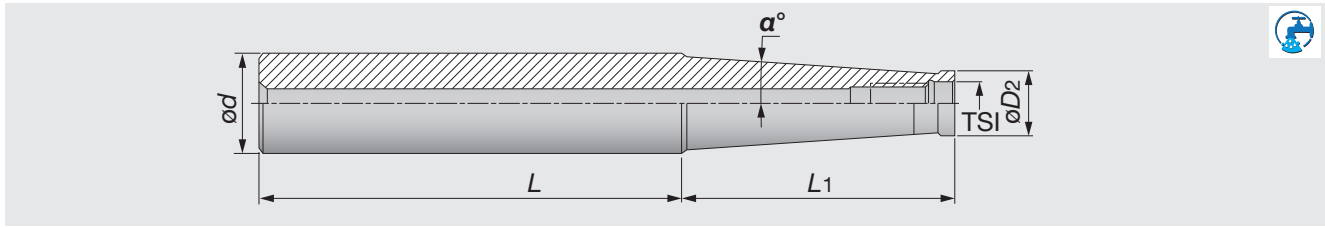

Metric	ϕd	ϕD_2	L	L ₁	α°	TSI
SM06-L60C10	10	9.7	60	20	0	M6
SM06-L105-C12	12	9.7	105	60	1.2	M6
SM06-L125-C16	16	9.7	125	60	3.3	M6
SM08-L73C16	16	13	73	25	0	M8
SM08-L128-C16	16	13	128	80	0.9	M8
SM08-L170-C20	20	13	170	66.8	3.3	M8
SM10-L80C20	20	18	80	30	0	M10
SM10-L130-C20	20	18	130	80	0.6	M10
SM10-L200-C25	25	19	200	57.2	3.3	M10
SM12-L86-C25	25	21	86	30	5.1	M12
SM12-L200-C32	32	21	200	78	4.4	M12
SM16-L95-C32	32	29	95	35	1.7	M16
SM16-L230-C32	32	29	230	50	1.8	M16

- All of the shanks have a coolant holes.
- Applicable for 10 MPa pressure coolant.

TUNGFIT TUNGFLEX

S M-CF4 TungFit adaptor

TungFlex conversion adaptor with TungFit

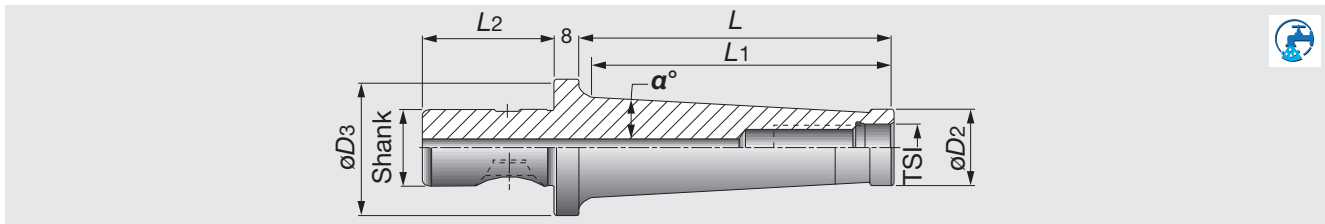

Metric	ϕD_2	L	L ₁	α°	shank	ϕD_3	L ₂	TSI
SM12-L85/3.30-CF4	21	93	81.3	4.4	CF4	44	42	M12
SM16-L130/5.11-CF4	29	138	126.8	2.6	CF4	44	42	M16
SM12-L140/5.50-CF4	21	148	139.1	4.4	CF4	44	42	M12
SM16-L170/6.70-CF4	29	178	168.6	2	CF4	44	42	M16

- Applicable for 10 MPa pressure coolant.

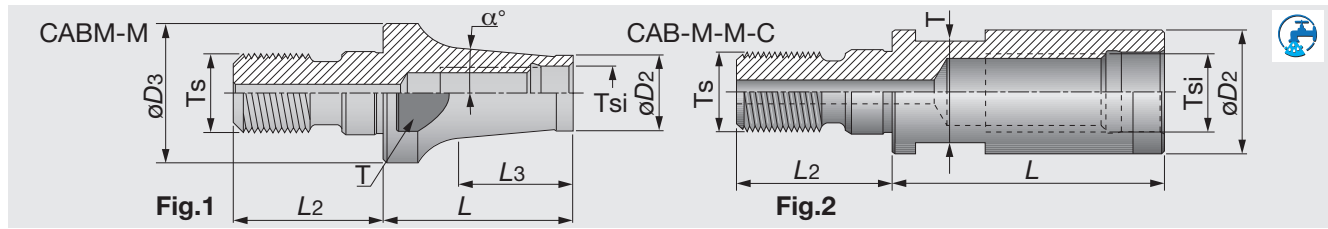

Metric	Ts	α°	ϕD_2	L	L3	ϕD_3	L2	T	Tsi	Fig
CABM06M08	M8	5.7	9.7	30	24.8	13	17.5	9.5	M6	1
CABM08M08-C ⁽¹⁾	M8	0	13	30	-	-	17.5	9.6	M8	2
CABM08M10	M10	5.2	13	40	33.4	18	20	15	M8	1
CABM10M10-C ⁽¹⁾	M10	0	18	35	-	-	20	15	M10	2
CABM10M12	M12	2.5	18	45	36.4	21	22	17	M10	1
CABM12M12-C ⁽¹⁾	M12	0	21	40	-	-	22	17	M12	2
CABM12M16	M16	6.3	21	50	42.5	29	25	25	M12	1
CABM16M16-C ⁽¹⁾	M16	0	29	40	-	-	25	25	M16	2

(1) With coolant holes
 • Applicable for 10 MPa pressure coolant.

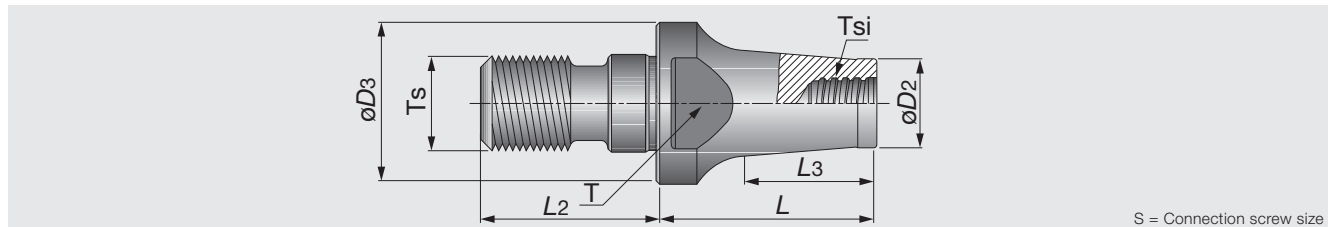

S = Connection screw size

Metric	ϕD_2	ϕD_3	L	L2	L3	Tsi	Ts	T
VAD130L016S08-S-M8	11.7	13	16	17.5	6	S08	M8	11
VAD130L025S08-S-M8	11.7	13	25	17.5	20	S08	M8	11
VAD180L020S08-S-M10	11.7	18	20	20	12	S08	M10	13
VAD180L025S08-S-M10	11.7	18	25	20	15	S08	M10	11
VAD210L020S08-S-M12	11.7	21	20	20	10	S08	M12	12.75
VAD210L025S08-S-M12	11.7	21	25	20	13	S08	M12	12.75

• Wrench size, used on flats for tightening (sold separately).
 • Do not apply lubricant to the threaded connection.
 • Applicable for 10 MPa pressure coolant.

TUNGFLEX

CDP-ER-M

TungFlex adaptor with ER collet chucks

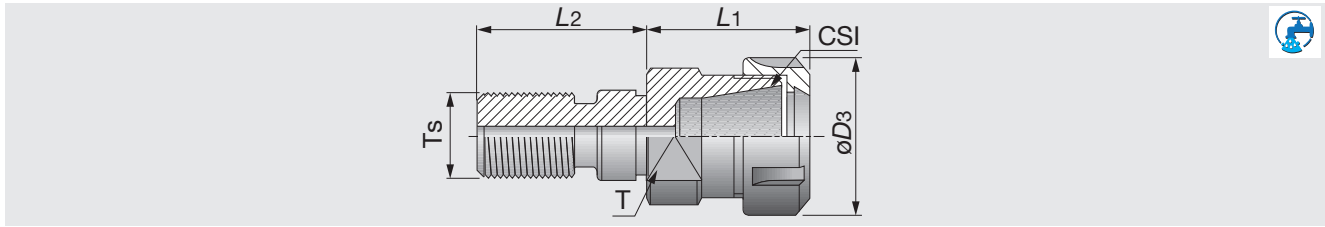

Metric	Ts	CSI	Range	L1	L2	øD3	T
CDPER11M10M	M10	ER11	0.5-7	27	20	16	15
CDPER16M10M	M10	ER16	0.5-10	38.1	20	22	17
CDPER11M12M	M12	ER11	0.5-7	27	22	16	17
CDPER16M12M	M12	ER16	0.5-10	37.1	22	22	17
CDPER16M16	M16	ER16	0.5-10	36.6	25	28	25
CDPER20M16	M16	ER20	1-13	45.5	25	34	25
CDPER25M16	M16	ER25	1-16	44.5	25	42	28

• Applicable for 10 MPa pressure coolant.

(Option = Wrench for ER collet)

TUNGFLEX

CDP-M-SRK

TungFlex adaptor with shrinking holder for carbide shank

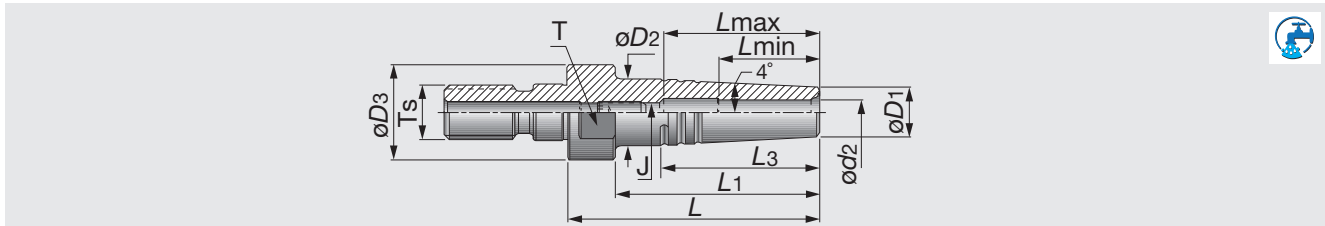

Metric	Ts	øD3	ød2	øD1	øD2	L	L1	L3	Lmin	Lmax	J	T	Key
CDPM10SRK3X40	M10	18	3	10	14	40	31.5	28.4	10	16	M4	15	2
CDPM10SRK4X40	M10	18	4	10	14	40	31.5	28.4	12	19	M4	15	2
CDPM10SRK5X40	M10	18	5	10	14	40	31.5	28.4	15	25	M4	15	2
CDPM12SRK3X45	M12	21	3	10	14	45	36.5	28.8	10	16	M5	18	2.5
CDPM12SRK4X45	M12	21	4	10	14	45	36.5	28.8	12	18	M5	18	2.5
CDPM12SRK5X45	M12	21	5	10	14	45	36.5	28.8	15	25	M5	18	2.5
CDPM12SRK6X45	M12	21	6	11	15	45	36.5	28.4	18	28	M5	18	2.5
CDPM12SRK8X45	M12	21	8	14	18	45	36.5	28.8	25	35	M5	18	2.5
CDPM12SRK10X45	M12	21	10	16	21	45	-	35.6	30	40	M5	18	2.5
CDPM12SRK12X45	M12	21	12	20	25	45	-	36.0	32	42	M5	18	2.5

• Applicable for 10 MPa pressure coolant.

TUNGFIT

EX-CF

TungFit extension adaptor



Tooling System

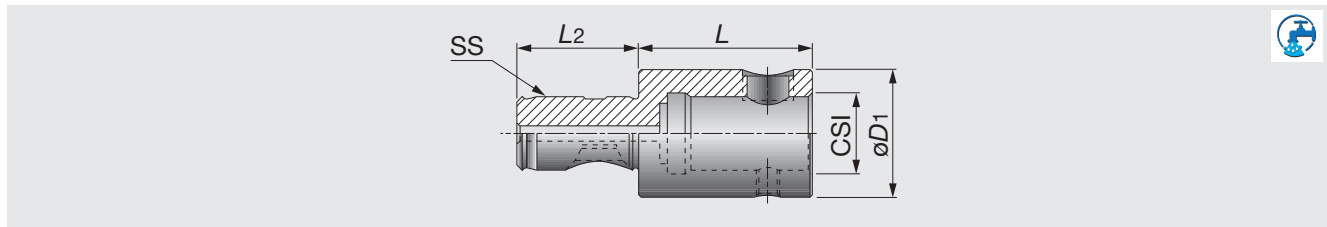

Metric	SS	L2	L	CSI	øD1
EXCF4-S	CF4	42	60	CF4	44
EXCF4-L	CF4	42	100	CF4	44

- Tightening torque: 58.8 N-m.
- Applicable for 10 MPa pressure coolant.

TUNGFIT

SEM-CF

TungFit shell mill adaptor



TUNGHOLD

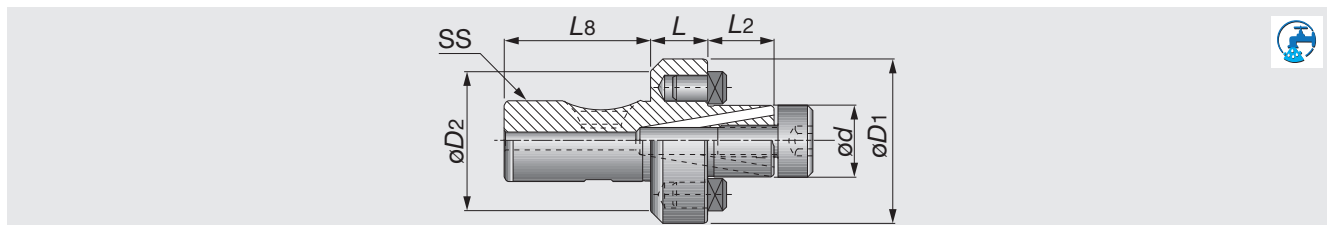

Metric	SS	ød	øD2	øD1	L	L2	L8
SEM22CF4C	CF4	22	44	47	16	19	42

- Tightening torque: 58.8 N-m.
- Applicable for 10 MPa pressure coolant.

(Option = Wrench for Lock Screw)

TUNGFIT

ER-CF

TungFit collet chuck adaptor

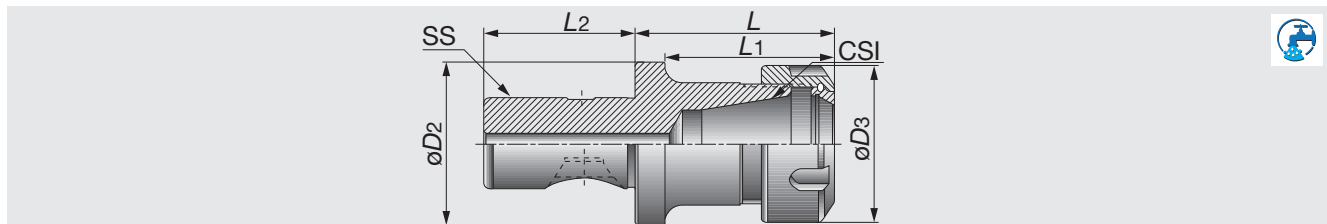

Metric	SS	CSI	Range	L	L1	L2	øD3	øD2
ER11CF4-S	CF4	ER11	0.5-7	55	47	42	19	44
ER16CF4-L	CF4	ER16	0.5-10	100	92	42	28	44
ER16CF4-S	CF4	ER16	0.5-10	55	47	42	28	44
ER20CF4-S	CF4	ER20	1-13	55	92	42	34	44
ER25CF4-S	CF4	ER25	1-16	55	47	42	42	44
ER32CF4-L	CF4	ER32	2-20	100	92	42	50	44
ER32CF4-S	CF4	ER32	2-20	55	47	42	50	44

- Tightening torque: 58.8 N-m.
- Applicable for 10 MPa pressure coolant.

(Option = Wrench for ER collet)



Shanks

CAT MAS-403, DIN69871



ST Straight Shank



MT Morse Taper

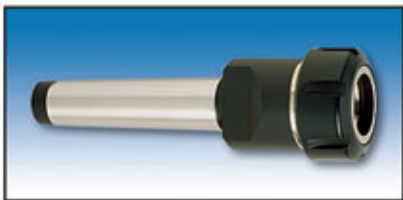

Collet Options

ER-SPR (ER Spring Collet)



**ER-SEAL
(ER SEAL Collet for Internal coolant)**

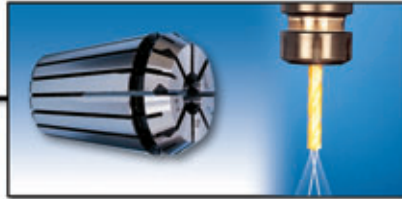

**ER-SEAL JET2
(ER SEAL Collet for External coolant)**



**ER-SRK
(ER Collet with SHRINK Holder)**



**ER32 GTIN
(ER Collet with Tapping Holder)**



**ER32 ODP
(ER Collet with Indexable Modular System)**





ER Collet standard DIN6499

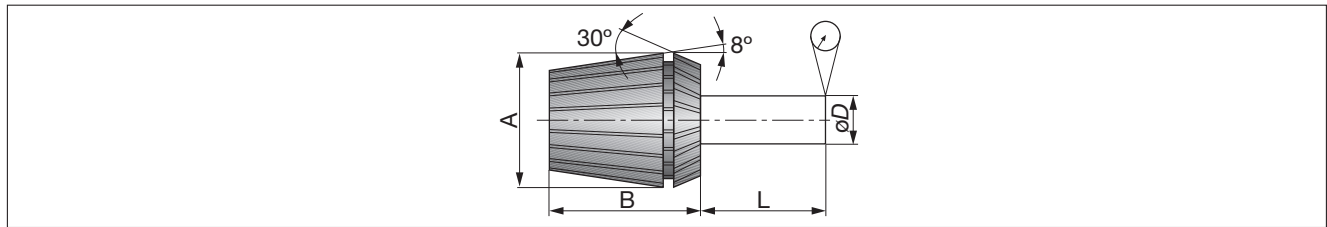

Collet type	A	B	L	øD	T.I.R Precision Standard type	T.I.R Precision "AA" Ultra Precision type	DIN6499
ER-11	11.5	18	6	1-1.6	0.01	0.005	-
ER-16	17	27	10	1.6-3	0.01	0.005	0.015
ER-20	21	31	16	3-6	0.01	0.005	0.015
ER-25	26	35	25	6-10	0.01	0.005	0.015
ER-32	33	40	40	10-18	0.01	0.005	0.020
ER-40	41	46	50	18-26	0.01	0.005	0.020
ER-50	52	60	60	26-34	0.01	-	0.025

ER - Coolit Sealed Collet



Sealed Collet Jet

For straight shank cutting tools with internal coolant supply.

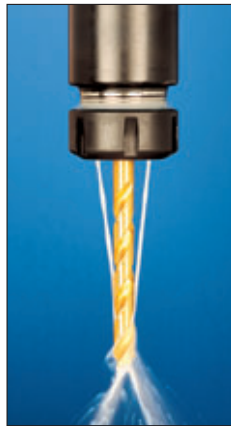

Sealed Collet JET2

With angular double nozzles. Coolant flow is direct to the cutting edge - for use with standard straight shank cutting tools (without coolant hole).

Standard Shank which can be used in Sealed Collets

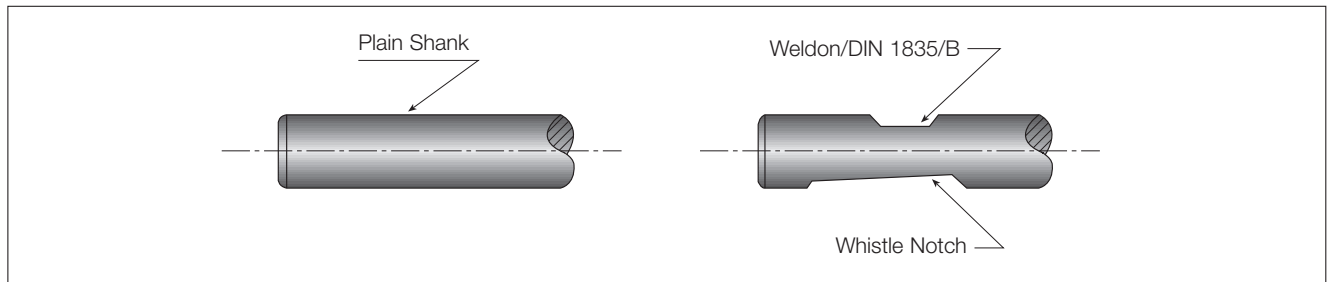

Note: The front end of the sealed collet should be located beyond weldon or the whistle notch.



SS

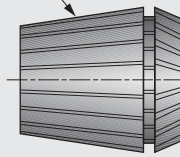

Range

Metric	SS	Range
ER11SPR0.5-1	ER11	0.5-1
ER11SPR1-2	ER11	1-2
ER11SPR2-3	ER11	2-3
ER11SPR3-4	ER11	3-4
ER11SPR4-5	ER11	4-5
ER11SPR5-6	ER11	5-6
ER11SPR6-7	ER11	6-7
ER16SPR0.5-1	ER16	0.5-1
ER16SPR1-2	ER16	1-2
ER16SPR2-3	ER16	2-3
ER16SPR3-4	ER16	3 - 4
ER16SPR4-5	ER16	4-5
ER16SPR5-6	ER16	5-6
ER16SPR6-7	ER16	6-7
ER16SPR7-8	ER16	7-8
ER16SPR8-9	ER16	8-9
ER16SPR9-10	ER16	9-10
ER20SPR1-2	ER20	1-2
ER20SPR2-3	ER20	2-3
ER20SPR3-4	ER20	3-4
ER20SPR4-5	ER20	4-5
ER20SPR5-6	ER20	5-6
ER20SPR6-7	ER20	6-7
ER20SPR7-8	ER20	7-8
ER20SPR8-9	ER20	8-9
ER20SPR9-10	ER20	9-10
ER20SPR10-11	ER20	10-11
ER20SPR11-12	ER20	11-12
ER20SPR12-13	ER20	12-13
ER25SPR1-2	ER25	1-2
ER25SPR2-3	ER25	2-3
ER25SPR3-4	ER25	3-4
ER25SPR4-5	ER25	4-5
ER25SPR5-6	ER25	5-6
ER25SPR6-7	ER25	6-7
ER25SPR7-8	ER25	7-8
ER25SPR8-9	ER25	8-9
ER25SPR9-10	ER25	9-10
ER25SPR10-11	ER25	10-11
ER25SPR11-12	ER25	11-12
ER25SPR12-13	ER25	12-13
ER25SPR13-14	ER25	13-14
ER25SPR14-15	ER25	14-15
ER25SPR15-16	ER25	15-16
ER32SPR2-3	ER32	2-3
ER32SPR3-4	ER32	3-4
ER32SPR4-5	ER32	4-5
ER32SPR5-6	ER32	5-6
ER32SPR6-7	ER32	6-7
ER32SPR7-8	ER32	7-8

Metric	SS	Range
ER32SPR8-9	ER32	8-9
ER32SPR9-10	ER32	9-10
ER32SPR10-11	ER32	10-11
ER32SPR11-12	ER32	11-12
ER32SPR12-13	ER32	12-13
ER32SPR13-14	ER32	13-14
ER32SPR14-15	ER32	14-15
ER32SPR15-16	ER32	15-16
ER32SPR16-17	ER32	16-17
ER32SPR17-18	ER32	17-18
ER32SPR18-19	ER32	18-19
ER32SPR19-20	ER32	19-20
ER40SPR3-4	ER40	3-4
ER40SPR4-5	ER40	4-5
ER40SPR5-6	ER40	5-6
ER40SPR6-7	ER40	6-7
ER40SPR7-8	ER40	7-8
ER40SPR8-9	ER40	8-9
ER40SPR9-10	ER40	9-10
ER40SPR10-11	ER40	10-11
ER40SPR11-12	ER40	11-12
ER40SPR12-13	ER40	12-13
ER40SPR13-14	ER40	13-14
ER40SPR14-15	ER40	14-15
ER40SPR15-16	ER40	15-16
ER40SPR16-17	ER40	16-17
ER40SPR17-18	ER40	17-18
ER40SPR18-19	ER40	18-19
ER40SPR19-20	ER40	19-20
ER40SPR20-21	ER40	20-21
ER40SPR21-22	ER40	21-22
ER40SPR22-23	ER40	22-23
ER40SPR23-24	ER40	23-24
ER40SPR24-25	ER40	24-25
ER40SPR25-26	ER40	25-26
ER50SPR10-12	ER50	10-12
ER50SPR12-14	ER50	12-14
ER50SPR14-16	ER50	14-16
ER50SPR16-18	ER50	16-18
ER50SPR18-20	ER50	18-20
ER50SPR20-22	ER50	20-22
ER50SPR22-24	ER50	22-24
ER50SPR24-26	ER50	24-26
ER50SPR26-28	ER50	26-28
ER50SPR28-30	ER50	28-30
ER50SPR30-32	ER50	30-32
ER50SPR32-34	ER50	32-34

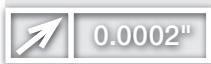

ULTRA PRECISION AA

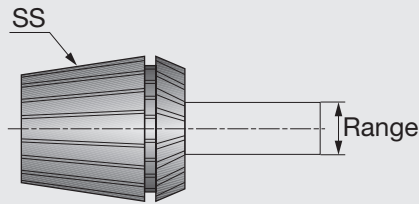

Metric	SS	Range
ER11SPR0.5-1AA	ER11	0.5-1
ER11SPR1-2AA	ER11	1-2
ER11SPR2-3AA	ER11	2-3
ER11SPR3-4AA	ER11	3-4
ER11SPR4-5AA	ER11	4-5
ER11SPR5-6AA	ER11	5-6
ER11SPR6-7AA	ER11	6-7
ER16SPR0.5-1AA	ER16	0.5-1
ER16SPR1-2AA	ER16	1-2
ER16SPR2-3AA	ER16	2-3
ER16SPR3-4AA	ER16	3-4
ER16SPR4-5AA	ER16	4-5
ER16SPR5-6AA	ER16	5-6
ER16SPR6-7AA	ER16	6-7
ER16SPR7-8AA	ER16	7-8
ER16SPR8-9AA	ER16	8-9
ER16SPR9-10AA	ER16	9-10
ER20SPR12-13AA	ER20	12-13
ER20SPR2-3AA	ER20	2-3
ER20SPR3-4AA	ER20	3-4
ER20SPR4-5AA	ER20	4-5
ER20SPR5-6AA	ER20	5-6
ER20SPR6-7AA	ER20	6-7
ER20SPR7-8AA	ER20	7-8
ER20SPR8-9AA	ER20	8-9
ER20SPR9-10AA	ER20	9-10
ER20SPR1-2AA	ER20	1-2
ER20SPR10-11AA	ER20	10-11
ER20SPR11-12AA	ER20	11-12
ER25SPR12-13AA	ER25	12-13
ER25SPR2-3AA	ER25	2-3
ER25SPR3-4AA	ER25	3-4
ER25SPR4-5AA	ER25	4-5
ER25SPR5-6AA	ER25	5-6
ER25SPR6-7AA	ER25	6-7
ER25SPR7-8AA	ER25	7-8
ER25SPR8-9AA	ER25	8-9
ER25SPR9-10AA	ER25	9-10
ER25SPR1-2AA	ER25	1-2
ER25SPR10-11AA	ER25	10-11
ER25SPR11-12AA	ER25	11-12
ER25SPR13-14AA	ER25	13-14
ER25SPR14-15AA	ER25	14-15
ER25SPR15-16AA	ER25	15-16
ER32SPR2-3AA	ER32	2-3
ER32SPR3-4AA	ER32	3-4
ER32SPR4-5AA	ER32	4-5
ER32SPR5-6AA	ER32	5-6
ER32SPR6-7AA	ER32	6-7
ER32SPR7-8AA	ER32	7-8

Metric	SS	Range
ER32SPR8-9AA	ER32	8-9
ER32SPR9-10AA	ER32	9-10
ER32SPR10-11AA	ER32	10-11
ER32SPR11-12AA	ER32	11-12
ER32SPR12-13AA	ER32	12-13
ER32SPR13-14AA	ER32	13-14
ER32SPR14-15AA	ER32	14-15
ER32SPR15-16AA	ER32	15-16
ER32SPR16-17AA	ER32	16-17
ER32SPR17-18AA	ER32	17-18
ER32SPR18-19AA	ER32	18-19
ER32SPR19-20AA	ER32	19-20
ER40SPR3-4AA	ER40	3-4
ER40SPR4-5AA	ER40	4-5
ER40SPR5-6AA	ER40	5-6
ER40SPR6-7AA	ER40	6-7
ER40SPR7-8AA	ER40	7-8
ER40SPR8-9AA	ER40	8-9
ER40SPR9-10AA	ER40	9-10
ER40SPR10-11AA	ER40	10-11
ER40SPR11-12AA	ER40	11-12
ER40SPR12-13AA	ER40	12-13
ER40SPR13-14AA	ER40	13-14
ER40SPR14-15AA	ER40	14-15
ER40SPR15-16AA	ER40	15-16
ER40SPR16-17AA	ER40	16-17
ER40SPR17-18AA	ER40	17-18
ER40SPR18-19AA	ER40	18-19
ER40SPR19-20AA	ER40	19-20
ER40SPR20-21AA	ER40	20-21
ER40SPR21-22AA	ER40	21-22
ER40SPR22-23AA	ER40	22-23
ER40SPR23-24AA	ER40	23-24
ER40SPR24-25AA	ER40	24-25
ER40SPR25-26AA	ER40	25-26



TUNGHOLD

ER-SEAL

DIN 6499 ER COOLIT, Sealed Spring Collets



SS

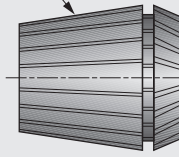

Range

Metric	SS	Range
ER16SEAL3-4	ER16	3-4
ER16SEAL4-5	ER16	4-5
ER16SEAL5-6	ER16	5-6
ER16SEAL6-7	ER16	6-7
ER16SEAL7-8	ER16	7-8
ER16SEAL8-9	ER16	8-9
ER16SEAL9-10	ER16	9-10
ER20SEAL3-4	ER20	3-4
ER20SEAL4-5	ER20	4-5
ER20SEAL5-6	ER20	5-6
ER20SEAL6-7	ER20	6-7
ER20SEAL7-8	ER20	7-8
ER20SEAL8-9	ER20	8-9
ER20SEAL9-10	ER20	9-10
ER20SEAL10-11	ER20	10-11
ER20SEAL11-12	ER20	11-12
ER20SEAL12-13	ER20	12-13
ER25SEAL3-4	ER25	3-4
ER25SEAL4-5	ER25	4-5
ER25SEAL5-6	ER25	5-6
ER25SEAL6-7	ER25	6-7
ER25SEAL7-8	ER25	7-8
ER25SEAL8-9	ER25	8-9
ER25SEAL9-10	ER25	9-10
ER25SEAL10-11	ER25	10-11
ER25SEAL11-12	ER25	11-12
ER25SEAL12-13	ER25	12-13
ER25SEAL13-14	ER25	13-14
ER25SEAL14-15	ER25	14-15
ER25SEAL15-16	ER25	15-16
ER32SEAL3-4	ER32	3-4
ER32SEAL4-5	ER32	4-5
ER32SEAL5-6	ER32	5-6
ER32SEAL6-7	ER32	6-7
ER32SEAL7-8	ER32	7-8
ER32SEAL8-9	ER32	8-9
ER32SEAL9-10	ER32	9-10
ER32SEAL10-11	ER32	10-11
ER32SEAL11-12	ER32	11-12
ER32SEAL12-13	ER32	12-13
ER32SEAL13-14	ER32	13-14
ER32SEAL14-15	ER32	14-15
ER32SEAL15-16	ER32	15-16
ER32SEAL16-17	ER32	16-17
ER32SEAL17-18	ER32	17-18
ER32SEAL18-19	ER32	18-19
ER32SEAL19-20	ER32	19-20
ER40SEAL3-4	ER40	3-4
ER40SEAL4-5	ER40	4-5
ER40SEAL5-6	ER40	5-6

Metric	SS	Range
ER40SEAL6-7	ER40	6-7
ER40SEAL7-8	ER40	7-8
ER40SEAL8-9	ER40	8-9
ER40SEAL9-10	ER40	9-10
ER40SEAL10-11	ER40	10-11
ER40SEAL11-12	ER40	11-12
ER40SEAL12-13	ER40	12-13
ER40SEAL13-14	ER40	13-14
ER40SEAL14-15	ER40	14-15
ER40SEAL15-16	ER40	15-16
ER40SEAL16-17	ER40	16-17
ER40SEAL17-18	ER40	17-18
ER40SEAL18-19	ER40	18-19
ER40SEAL19-20	ER40	19-20
ER40SEAL20-21	ER40	20-21
ER40SEAL21-22	ER40	21-22
ER40SEAL22-23	ER40	22-23
ER40SEAL23-24	ER40	23-24
ER40SEAL24-25	ER40	24-25
ER40SEAL25-26	ER40	25-26

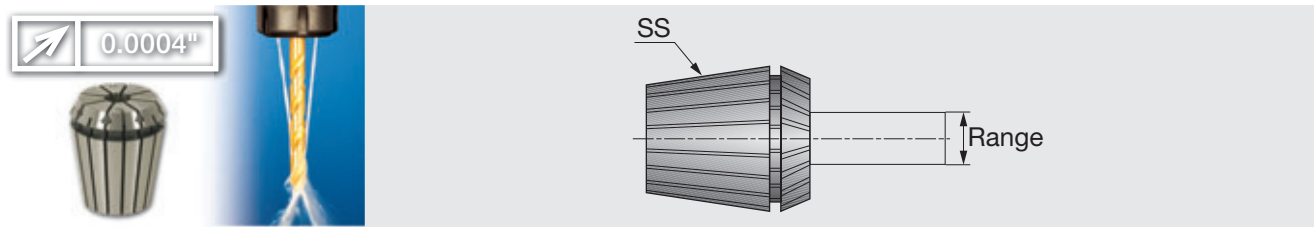

Metric	SS	Range	Metric	SS	Range
ER16SEAL3-4JET2	ER16	3-4	ER40SEAL6-7JET2	ER40	6-7
ER16SEAL4-5JET2	ER16	4-5	ER40SEAL7-8JET2	ER40	7-8
ER16SEAL5-6JET2	ER16	5-6	ER40SEAL8-9JET2	ER40	8-9
ER16SEAL6-7JET2	ER16	6-7	ER40SEAL9-10JET2	ER40	9-10
ER16SEAL7-8JET2	ER16	7-8	ER40SEAL10-11JET2	ER40	10-11
ER16SEAL8-9JET2	ER16	8-9	ER40SEAL11-12JET2	ER40	11-12
ER16SEAL9-10JET2	ER16	9-10	ER40SEAL12-13JET2	ER40	12-13
ER20SEAL3-4JET2	ER20	3-4	ER40SEAL13-14JET2	ER40	13-14
ER20SEAL4-5JET2	ER20	4-5	ER40SEAL14-15JET2	ER40	14-15
ER20SEAL5-6JET2	ER20	5-6	ER40SEAL15-16JET2	ER40	15-16
ER20SEAL6-7JET2	ER20	6-7	ER40SEAL16-17JET2	ER40	16-17
ER20SEAL7-8JET2	ER20	7-8	ER40SEAL17-18JET2	ER40	17-18
ER20SEAL8-9JET2	ER20	8-9	ER40SEAL18-19JET2	ER40	18-19
ER20SEAL9-10JET2	ER20	9-10	ER40SEAL19-20JET2	ER40	19-20
ER20SEAL10-11JET2	ER20	10-11	ER40SEAL20-21JET2	ER40	20-21
ER20SEAL11-12JET2	ER20	11-12	ER40SEAL21-22JET2	ER40	21-22
ER20SEAL12-13JET2	ER20	12-13	ER40SEAL22-23JET2	ER40	22-23
ER25SEAL3-4JET2	ER25	3-4	ER40SEAL23-24JET2	ER40	23-24
ER25SEAL4-5JET2	ER25	4-5	ER40SEAL24-25JET2	ER40	24-25
ER25SEAL5-6JET2	ER25	5-6	ER40SEAL25-26JET2	ER40	25-26
ER25SEAL6-7JET2	ER25	6-7			
ER25SEAL7-8JET2	ER25	7-8			
ER25SEAL8-9JET2	ER25	8-9			
ER25SEAL9-10JET2	ER25	9-10			
ER25SEAL10-11JET2	ER25	10-11			
ER25SEAL11-12JET2	ER25	11-12			
ER25SEAL12-13JET2	ER25	12-13			
ER25SEAL13-14JET2	ER25	13-14			
ER25SEAL14-15JET2	ER25	14-15			
ER25SEAL15-16JET2	ER25	15-16			
ER32SEAL3-4JET2	ER32	3-4			
ER32SEAL4-5JET2	ER32	4-5			
ER32SEAL5-6JET2	ER32	5-6			
ER32SEAL6-7JET2	ER32	6-7			
ER32SEAL7-8JET2	ER32	7-8			
ER32SEAL8-9JET2	ER32	8-9			
ER32SEAL9-10JET2	ER32	9-10			
ER32SEAL10-11JET2	ER32	10-11			
ER32SEAL11-12JET2	ER32	11-12			
ER32SEAL12-13JET2	ER32	12-13			
ER32SEAL13-14JET2	ER32	13-14			
ER32SEAL14-15JET2	ER32	14-15			
ER32SEAL15-16JET2	ER32	15-16			
ER32SEAL16-17JET2	ER32	16-17			
ER32SEAL17-18JET2	ER32	17-18			
ER32SEAL18-19JET2	ER32	18-19			
ER32SEAL19-20JET2	ER32	19-20			
ER40SEAL3-4JET2	ER40	3-4			
ER40SEAL4-5JET2	ER40	4-5			
ER40SEAL5-6JET2	ER40	5-6			



TUNGHOLD

SET ER-SPR

Sets of DIN 6499 ER spring collets with hard touch coating



Metric	Collet size	Qty	Range
SETER11SPR7	ER11	7	0.5-7
SETER16SPR10	ER16	10	0.5-10
SETER20SPR12	ER20	12	1-13
SETER25SPR15	ER25	15	1-16
SETER32SPR18	ER32	18	2-20
SETER40SPR23	ER40	23	3-26
SETER50SPR12	ER50	12	10-34

TUNGHOLD

SET ER-SPR-AA

Sets of DIN 6499 ER 'AA' ultra precise spring collets with hard touch coating



Metric	Collet size	Qty	Range
SETER11SPR7AA	ER11	7	0.5-7
SETER16SPR10AA	ER16	10	0.5-10
SETER20SPR12AA	ER20	12	1-13
SETER25SPR15AA	ER25	15	1-16
SETER32SPR18AA	ER32	18	2-20
SETER40SPR23AA	ER40	23	3-26

TUNGHOLD

SET ER-SEAL

Sets of DIN 6499 ER coolant collets with hard touch coating, sealed for 100 bar

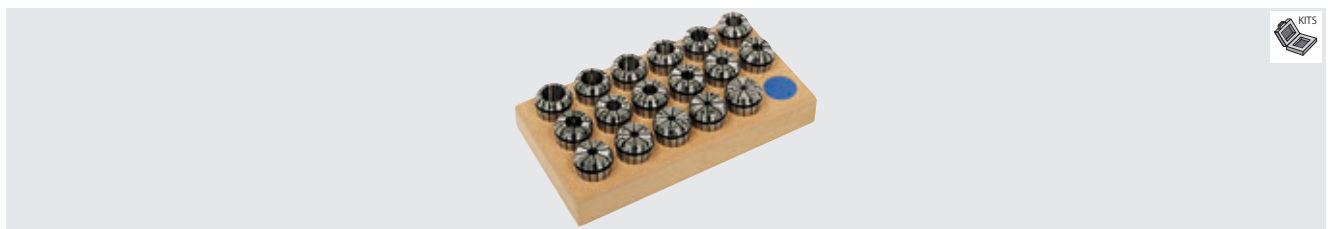

Metric	Collet size	Qty	Range
SETER16SEAL7	ER16	7	3-10
SETER20SEAL10	ER20	10	3-13
SETER25SEAL13	ER25	13	3-16
SETER32SEAL17	ER32	17	3-20
SETER40SEAL23	ER40	23	3-26

TUNGHOLD

SET ER-SEAL-JET2

Sets of ER collet, sealed for 1450 PSI collets with hard touch coating, sealed for 100 bar

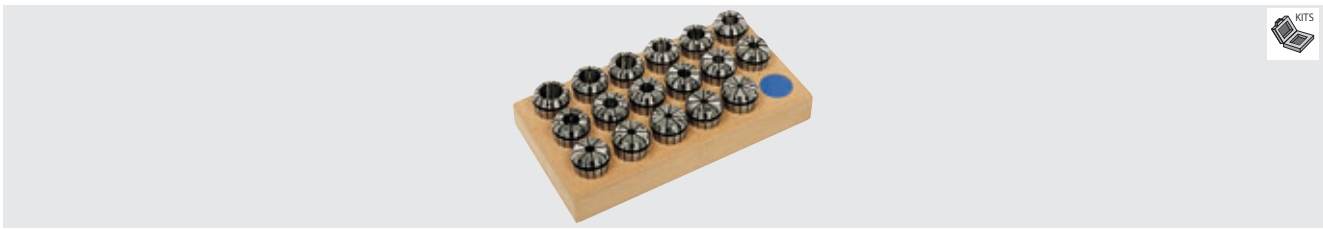

Metric	Collet size	Qty	Range
SETER16SEAL7JET2	ER16	7	3-13
SETER25SEAL13JET2	ER25	13	3-20
SETER32SEAL17JET2	ER32	17	3-26
SETER40SEAL23JET2	ER40	23	3-26

TUNGHOLD

SET ER SPR-EM⁽¹⁾

Sets of ER spring collets DIN 6499 with hard touch coating



Metric	Collet size	Qty	Range
SETER16SPR8EM	ER16	8	3,4,5,6,7,8,9,10
SETER20SPR5EM	ER20	5	4,6,8,10,12
SETER25SPR6EM	ER25	6	4,6,8,10,12,16
SETER32SPR6EM	ER32	6	6,8,10,12,16,20
SETER40SPR7EM	ER40	7	6,8,10,12,16,20,25

(1) Contains popular endmill sizes only.

TUNGHOLD

SET-ER SEAL-EM⁽¹⁾

A Set of ER collet, JET collets, sealed for up to 100 bar.the hard touch coating, sealed for 100 bar

Metric	Collet size	Qty	Range
SETER16SEAL5EM	ER16	5	4,5,6,8,10
SETER20SEAL5EM	ER20	5	4,6,8,10,12
SETER25SEAL6EM	ER25	6	4,6,8,10,12,16
SETER32SEAL6EM	ER32	6	6,8,10,12,16,20
SETER40SEAL7EM	ER40	7	6,8,10,12,16,20,25

(1) Contains popular endmill sizes only.



Tooling System

TUNGHOLD



TUNGSHOLD

SET ER-SEAL-EM JET2⁽¹⁾

A set of ER collet, JET2 collets, sealed for up to 100 bar

Metric	Collet size	Qty	Range
SETER25SEAL6EMJET2	ER25	6	4,6,8,10,12,16
SETER32SEAL6EMJET2	ER32	6	6,8,10,12,16,20
SETER40SEAL7EMJET2	ER40	7	6,8,10,12,16,20,25

(1) Contains popular endmill sizes only.

TUNGSHOLD

KIT R-8-ER

The Kit contains ER collet chuck with a bridgeport shank and a set of collets in various bore sizes



Metric	Collet size	Qty	Range
KITR-810ER16	ER16	10	0.5-10
KITR-818ER32	ER32	18	2-20

• Each kit contains one collet chuck, a full set of ER collets and a Wrench.

TUNGSHOLD

KIT DIN2080-ER

The Kit contains 1 DIN 2080 taper shank with ER collet chuck and a set of ER spring collets



Metric	Collet size	Qty	Range
KITDIN20803018ER32	ER32	18	2-20
KITDIN20804018ER32	ER32	18	2-20
KITDIN20804023ER40	ER40	23	3-26
KITDIN20805023ER40	ER40	23	3-26

• Each kit contains one collet chuck, a full set of ER collets and a Wrench.

TUNGHOLD

KIT MT-ER

The Kits contain ER collet chuck with a morse taper shank and a set of collets in various bore sizes



Metric	Collet size	Qty	Range
KITMT318ER32	ER32	18	2-20
KITMT423ER40	ER40	23	3-26

• Each kit contains one collet chuck, a full set of ER collets and a Wrench.

TUNGHOLD

KIT ST-ER-Mini

The Kits contain ER Mini collet chuck with a cylindrical shank and a set of collets in various bore sizes



Metric	Collet size	Qty	Range
KITST12X807ER11M	ER11	7	0.5-7
KITST12X8010ER16M	ER16	10	0.5-10
KITST16X507ER11MF	ER11	7	0.5-7
KITST16X1007ER11M	ER11	7	0.5-7
KITST16X1507ER11M	ER11	7	0.5-7
KITST20X10010ER16M	ER16	10	0.5-10
KITST20X15010ER16M	ER16	10	0.5-10
KITST20X10012ER20M	ER20	12	1-12
KITST20X15012ER20M	ER20	12	1-12

• Each kit contains one collet chuck, a full set of ER collets and a Wrench. • F indicates a flat on the shank.



TUNGHOLD

KIT ST-ER

Contains 1 ER collet chuck with a cylindrical shank and a set of collets in various bore sizes



Metric	Collet size	Qty	Range
KITST16X507ER11F	ER11	7	0.5-7
KITST20X1007ER11	ER11	7	0.5-7
KITST20X1507ER11	ER11	7	0.5-7
KITST20X5010ER16F	ER16	10	0.5-10
KITST20X10010ER16	ER16	10	0.5-10
KITST20X15010ER16	ER16	10	0.5-10
KITST20X5012ER20F	ER20	12	1-12
KITST25X10012ER20	ER20	12	1-12

• Each kit contains one collet chuck, a full set of ER collets and a Wrench. • F indicates a flat on the shank.

TUNGMAX

SC-SPR

SC straight collets for TungMax power chucks

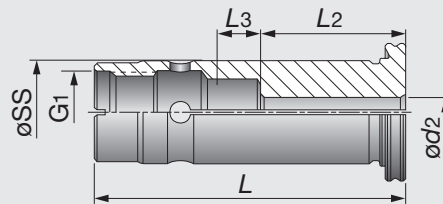

Metric	ød2	øSS	L	L2	L3	G1
SC20SPR6	6	20	60	28	7	M16
SC20SPR8	8	20	60	28	7	M16
SC20SPR10	10	20	60	35	13	M16
SC20SPR12	12	20	60	40	8	M16
SC20SPR14	14	20	60	40	8	M16
SC20SPR15	15	20	60	40	8	M16
SC20SPR16	16	20	60	39	9	M16
SC32SPR6	6	32	72	28	17	M24X1.5
SC32SPR8	8	32	72	28	17	M24X1.5
SC32SPR10	10	32	72	35	13	M24X1.5
SC32SPR12	12	32	72	40	5	M24X1.5
SC32SPR14	14	32	72	40	5	M24X1.5
SC32SPR15	15	32	72	40	19.5	M24X1.5
SC32SPR16	16	32	72	44	17.5	M24X1.5
SC32SPR18	18	32	72	44	17.5	M24X1.5
SC32SPR19	19	32	72	44	17.5	M24X1.5
SC32SPR20	20	32	72	46	15.5	M24X1.5
SC32SPR24	24	32	72	45	10.5	M24X1.5
SC32SPR25	25	32	72	51	10.5	M24X1.5

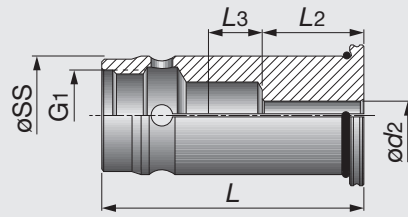

Metric	$\phi d2$	ϕSS	L	L2	L3	G1
SC20SEAL6	6	20	60	28	7	M16
SC20SEAL8	8	20	60	28	7	M16
SC20SEAL10	10	20	60	35	13	M16
SC20SEAL12	12	20	60	40	8	M16
SC20SEAL14	14	20	60	40	8	M16
SC20SEAL15	15	20	60	40	8	M16
SC20SEAL16	16	20	60	39	9	M16
SC32SEAL6	6	32	72	28	17	M24X1.5
SC32SEAL8	8	32	72	28	17	M24X1.5
SC32SEAL10	10	32	72	35	13	M24X1.5
SC32SEAL12	12	32	72	40	5	M24X1.5
SC32SEAL14	14	32	72	40	5	M24X1.5
SC32SEAL15	15	32	72	40	5	M24X1.5
SC32SEAL16	16	32	72	44	17.5	M24X1.5
SC32SEAL18	18	32	72	44	17.5	M24X1.5
SC32SEAL19	19	32	72	44	17.5	M24X1.5
SC32SEAL20	20	32	72	46	15.5	M24X1.5
SC32SEAL24	24	32	72	46	15.5	M24X1.5
SC32SEAL25	25	32	72	51	10.5	M24X1.5

TUNGMAX

PRESET SC-CAP

Preset screw housing for SC-SPR TungMax collets

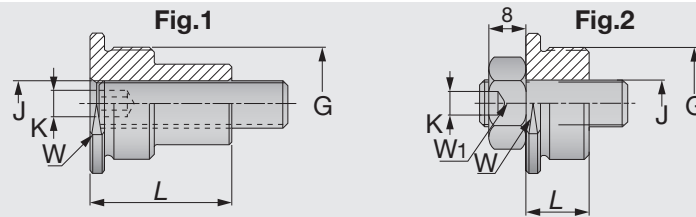

Metric	L	W	J	G	Fig	Range	Key	CSI
PRESETSCCAP8x1.25L	28	16	M8X25	M16	1	6-8	4	SC20
PRESETSCCAP8x1.25	15	16	M8X25	M16	2	10-16	4	SC20
PRESETSCCAP10x1.5L	30	27	M10X30	M24X1.5	1	6-14	5	SC32
PRESETSCCAP10x1.5	13.5	27	M10X30	M24X1.5	2	16-25	5	SC32



TUNGHYDRO

KIT CAT-HYDRO

Hydraulic chuck kits with MAS-CAT Form A/B Shanks



Inch	CAT size	ød2	Qty	Range
KITCAT40HYDRO20X73	40	20	5	8,10,12,14,16
KITCAT40HYDRO32X110	40	32	7	6,8,10,12,16,20,25

- Each kit contains one HYDROFIT chuck, a set of SC...HYDRO sealed reducers and a clamping wrench.

(Unit: mm)

TUNGHYDRO

KIT DIN69871-HYDRO

Contains a hydraulic chuck with a DIN69781 tapered shank and a set of collets in various bore sizes



Metric	SK size	ød2	Qty	Range
KITDIN6987140HYDRO20X65	40	20	5	8,10,12,14,16
KITDIN6987140HYDRO32X117	40	32	7	6,8,10,12,16,20,25

- Each kit contains one HYDROFIT chuck, a set of SC...HYDRO sealed reducers and a clamping wrench.

TUNGHYDRO

KIT HSK A-HYDRO

Contains a hydraulic chuck with HSK tapered shank and a set of collets in various bore sizes

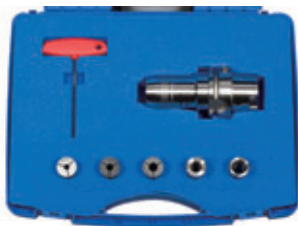

Metric	HSK size	ød2	Qty	Range
KITHSKA63HYDRO20X100	63	20	5	8,10,12,14,16
KITHSKA63HYDRO32X125	63	32	7	6,8,10,12,16,20,25

- Each kit contains one HYDROFIT chuck, a set of SC...HYDRO sealed reducers and a clamping wrench.

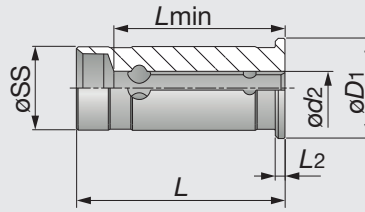

Inch	øSS	ød2	Lmin	L	øD1	L2
SC 3/4 S HYDRO 1/8	0.750	0.125	1.180	1.965	0.945	0.080
SC 3/4 S HYDRO 1/4	0.750	0.250	1.180	1.965	0.945	0.080
SC 3/4 S HYDRO 5/16	0.750	0.313	1.180	1.965	0.945	0.080
SC 3/4 S HYDRO 3/8	0.750	0.375	1.180	1.965	0.945	0.080
SC 3/4 S HYDRO 1/2	0.750	0.500	1.450	1.965	0.945	0.080
SC 3/4 S HYDRO 5/8	0.750	0.625	1.450	1.965	0.945	0.080
SC 1 1/4 S HYDRO 1/4	1.250	0.250	0.980	2.598	1.400	0.160
SC 1 1/4 S HYDRO 5/16	1.250	0.313	0.980	2.598	1.400	0.160
SC 1 1/4 S HYDRO 3/8	1.250	0.375	0.980	2.598	1.400	0.160
SC 1 1/4 S HYDRO 1/2	1.250	0.500	1.380	2.598	1.400	0.160
SC 1 1/4 S HYDRO 5/8	1.250	0.625	1.380	2.598	1.400	0.160
SC 1 1/4 S HYDRO 3/4	1.250	0.750	1.970	2.598	1.400	0.160
SC 1 1/4 S HYDRO 1"	1.250	1.000	2.600	2.598	1.400	0.160

Metric	øSS	ød2	Lmin	L	øD1	L2
SC12SHYDRO3	12	3	19	46.5	16	2
SC12SHYDRO4	12	4	24	46.5	16	2
SC12SHYDRO5	12	5	28	46.5	16	2
SC12SHYDRO6	12	6	33	46.5	16	2
SC12SHYDRO8	12	8	39	46.5	16	2
SC20SHYDRO3	20	3	20	53	24	2
SC20SHYDRO4	20	4	25	53	24	2
SC20SHYDRO5	20	5	27	53	24	2
SC20SHYDRO6	20	6	34	53	24	2
SC20SHYDRO8	20	8	39	53	24	2
SC20SHYDRO10	20	10	40	53	24	2
SC20SHYDRO12	20	12	41	53	24	2
SC20SHYDRO14	20	14	44	53	24	2
SC20SHYDRO16	20	16	44	53	24	2
SC25SHYDRO6	25	6	37	60	30	4
SC25SHYDRO8	25	8	37	60	30	4
SC25SHYDRO10	25	10	40	60	30	4
SC25SHYDRO12	25	12	44	60	30	4
SC25SHYDRO14	25	14	46	60	30	4
SC25SHYDRO16	25	16	48	60	30	4
SC25SHYDRO18	25	18	50	60	30	4
SC25SHYDRO20	25	20	50	60	30	4
SC32SHYDRO6	32	6	33	66	40	4
SC32SHYDRO8	32	8	38	66	40	4
SC32SHYDRO10	32	10	39	66	40	4
SC32SHYDRO12	32	12	42	66	40	4
SC32SHYDRO14	32	14	44	66	40	4
SC32SHYDRO16	32	16	44	66	40	4
SC32SHYDRO18	32	18	44	66	40	4
SC32SHYDRO20	32	20	49	66	40	4
SC32SHYDRO25	32	25	66	66	40	4



TUNGHYDRO

PRESET SCREW HYDRO

Tool stopper preset screws for the HYDRO collet chucks

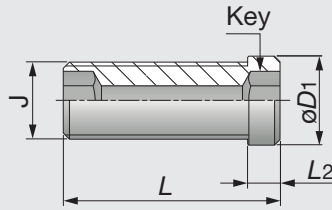

Metric	$\phi D1$	J	L	L2	Key
PRESETSCREWHYDROM5	5	M5	14	1	2.5
PRESETSCREWHYDROM6	6	M6	14	1.5	3
PRESETSCREWHYDROM8	8	M8X1	14	2	4
PRESETSCREWHYDROM10	10	M10X1	17	2	5
PRESETSCREWHYDROM16	14	M16X1	20	2	8

TUNGHYDRO

TEST BAR HYDRO

Torque test bars for hydraulic chucks

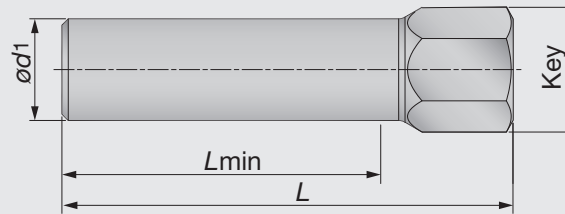

Metric	$\phi d1$	L	Key	Lmin ⁽¹⁾	Torque*
TESTBARHYDRO6	6	53	10	27	15
TESTBARHYDRO8	8	53	10	27	25
TESTBARHYDRO10	10	56	10	32	50
TESTBARHYDRO12	12	62	10	37	110
TESTBARHYDRO14	14	62	10	37	120
TESTBARHYDRO16	16	71	17	37	180
TESTBARHYDRO18	18	71	17	42	230
TESTBARHYDRO20	20	71	17	42	250
TESTBARHYDRO25	25	79	17	48	310
TESTBARHYDRO32	32	87	17	52	450

*Torque: Recommended torque (Nm) for clamping. (1) Minimum holding length.



Metric	Collet size	Qty	Range
SETSC20SPR6	20	6	6,8,10,12,14,16
SETSC32SPR9	32	9	6,8,10,12,14,16,18,20,25



Metric	Collet size	Qty	Range
SETSC20SEAL6	20	6	6,8,10,12,14,16
SETSC32SEAL9	32	9	6,8,10,12,14,16,18,20,25

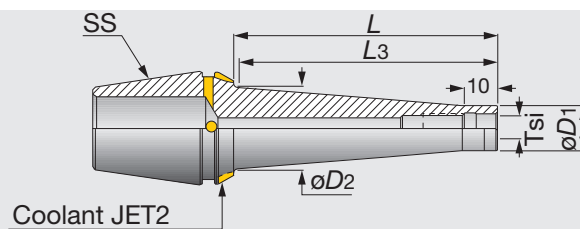

Metric	Tsi	SS	øD1	øD2	L	L3
ER32ODPM6X25	M6	ER32	9.8	14	25	22
ER32ODPM6X50	M6	ER32	9.8	20	50	48
ER32ODPM6X75	M6	ER32	9.8	23	75	74
ER32ODPM8X25	M8	ER32	13.1	15	25	22
ER32ODPM8X50	M8	ER32	13.1	23	50	49
ER32ODPM8X75	M8	ER32	13.1	23	75	74
ER32ODPM10X25	M10	ER32	18	20	25	23
ER32ODPM10X50	M10	ER32	18	24	50	49
ER32ODPM12X25	M12	ER32	21	24	25	24
ER32ODPM12X50	M12	ER32	21	24	50	49

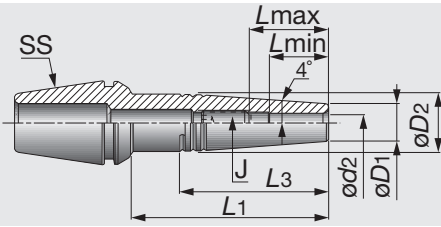

Inch	SS	ød2	øD1	øD2	L1	L3	Lmin	Lmax	J	Key
ER20 SRK 1/8X1.500	ER20	0.125	0.394	0.53	1.5	0.97	0.39	0.63	M6	0.118
ER20 SRK 1/8X2.500	ER20	0.125	0.394	0.53	2.5	0.97	0.39	0.63	M6	0.118
ER25 SRK 1/8X1.500	ER25	0.125	0.394	0.55	1.5	1.11	0.39	0.63	M6	0.118
ER25 SRK 1/8X2.500	ER25	0.125	0.394	0.63	2.5	1.71	0.39	0.63	M6	0.118
ER32 SRK 1/8X1.500	ER32	0.125	0.394	0.55	1.5	1.1	0.39	0.63	M6	0.118
ER32 SRK 1/8X2.500	ER32	0.125	0.394	0.68	2.5	2.0	0.39	0.63	M6	0.118
ER32 SRK 1/8X3.500	ER32	0.125	0.394	0.82	3.5	3.0	0.39	0.63	M6	0.118
ER20 SRK 3/16X2.500	ER20	0.187	0.394	0.53	2.5	0.97	0.59	0.83	M6	0.118
ER20 SRK 3/16X1.500	ER20	0.187	0.394	0.53	1.5	0.97	0.59	0.83	M6	0.118
ER25 SRK 3/16X1.500	ER25	0.187	0.394	0.55	1.5	1.11	0.59	0.83	M6	0.118
ER25 SRK 3/16X2.500	ER25	0.187	0.394	0.63	2.5	1.71	0.59	0.83	M6	0.118
ER32 SRK 3/16X1.500	ER32	0.187	0.394	0.55	1.5	1.11	0.59	0.83	M6	0.118
ER32 SRK 3/16X2.500	ER32	0.187	0.394	0.66	2.5	1.9	0.59	0.83	M6	0.118
ER32 SRK 3/16X3.500	ER32	0.187	0.394	0.80	3.5	2.9	0.59	0.83	M6	0.118
ER20 SRK 1/4X1.500	ER20	0.25	0.433	0.59	1.5	1.14	0.71	0.95	M8	0.157
ER20 SRK 1/4X2.500	ER20	0.25	0.433	0.62	2.5	1.31	0.71	0.95	M8	0.157
ER25 SRK 1/4X1.500	ER25	0.25	0.433	0.59	1.5	1.14	0.71	0.95	M8	0.157
ER25 SRK 1/4X2.500	ER25	0.25	0.433	0.70	2.5	1.9	0.71	0.95	M8	0.157
ER32 SRK 1/4X1.500	ER32	0.25	0.433	0.59	1.5	1.14	0.71	0.95	M8	0.157
ER32 SRK 1/4X2.500	ER32	0.25	0.433	0.7	2.5	1.91	0.71	0.97	M8	0.157
ER32 SRK 1/4X3.500	ER32	0.25	0.433	0.84	3.5	2.9	0.71	1.02	M8	0.157
ER32 SRK 5/16X1.500	ER32	0.313	0.551	0.76	1.5	1.44	0.98	1.22	M10	0.197
ER32 SRK 5/16X2.500	ER32	0.313	0.551	0.82	2.5	1.91	0.98	1.22	M10	0.197
ER32 SRK 5/16X3.500	ER32	0.313	0.551	0.93	3.5	2.71	0.98	1.22	M10	0.197
ER25 SRK 5/16X1.500	ER25	0.313	0.551	0.71	1.5	1.08	0.98	1.22	M10	0.197
ER25 SRK 5/16X2.500	ER25	0.313	0.551	0.79	2.5	1.71	0.98	1.22	M10	0.197
ER32 SRK 3/8X1.500	ER32	0.375	0.629	0.84	1.5	1.46	1.18	1.38	M12	0.236
ER32 SRK 3/8X2.500	ER32	0.375	0.629	0.90	2.5	1.9	1.18	1.42	M12	0.236
ER32 SRK 3/8X3.500	ER32	0.375	0.629	0.93	3.5	2.12	1.18	1.42	M12	0.236
ER32 SRK 7/16X1.500	ER32	0.437	0.787	0.94	1.5	1.11	1.22	1.42	M14	0.236
ER32 SRK 7/16X2.500	ER32	0.437	0.787	0.94	2.5	1.11	1.22	1.46	M14	0.236
ER32 SRK 7/16X3.500	ER32	0.437	0.787	0.94	3.5	1.11	1.22	1.46	M14	0.236
ER32 SRK 1/2X1.500	ER32	0.500	0.787	0.94	1.5	1.1	1.26	1.46	M14	0.236
ER32 SRK 1/2X2.500	ER32	0.500	0.787	0.94	2.5	1.1	1.26	1.5	M14	0.236
ER32 SRK 1/2X3.500	ER32	0.500	0.787	0.94	3.5	1.41	1.26	1.5	M14	0.236

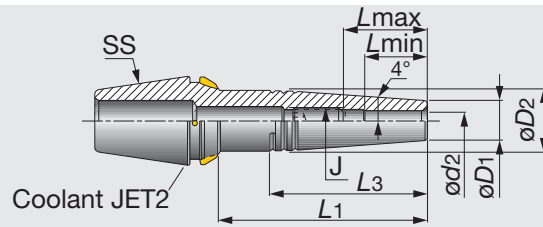

Metric	SS	ød2	øD1	øD2	L1	L3	Lmin	Lmax	J	Key
ER20SRK3X35JET2	ER20	3	10	13.5	35	24.5	10	16	M6	3
ER20SRK5X35JET2	ER20	5	10	13.5	35	24.5	15	21	M6	3
ER20SRK6X35JET2	ER20	6	11	14.7	35	25.5	18	24	M8	4
ER20SRK6X60JET2	ER20	6	11	15.2	60	29.5	18	24	M8	4
ER25SRK3X35JET2	ER25	3	10	13.5	35	24.5	10	16	M6	3
ER25SRK3X60JET2	ER25	3	10	16.3	60	44.5	10	16	M6	3
ER25SRK4X35JET2	ER25	4	10	13.5	35	24.5	12	18	M6	3
ER25SRK4X60JET2	ER25	4	10	16.3	60	44.5	12	18	M6	3
ER25SRK5X35JET2	ER25	5	10	13.5	35	24.5	15	21	M6	3
ER25SRK5X60JET2	ER25	5	10	16.3	60	44.5	15	21	M6	3
ER25SRK6X35JET2	ER25	6	11	14.7	35	26	18	24	M8	4
ER25SRK6X60JET2	ER25	6	11	17.3	60	44.5	18	24	M8	4
ER25SRK8X35JET2	ER25	8	14	17.8	35	26.5	25	30	M10	5
ER25SRK8X60JET2	ER25	8	14	19.7	60	39.5	25	31	M10	5
ER32SRK3X35JET2	ER32	3	10	13.2	35	22.5	10	16	M6	3
ER32SRK3X60JET2	ER32	3	10	16.3	60	44.5	10	16	M6	3
ER32SRK3X85JET2	ER32	3	10	19.8	85	70	10	16	M6	3
ER32SRK4X35JET2	ER32	4	10	13.4	35	23.5	12	18	M6	3
ER32SRK4X60JET2	ER32	4	10	16.3	60	44.5	12	18	M6	3
ER32SRK4X85JET2	ER32	4	10	19.8	85	70	12	18	M6	3
ER32SRK5X35JET2	ER32	5	10	13.5	35	24.5	15	21	M6	3
ER32SRK5X60JET2	ER32	5	10	16.3	60	44.5	15	21	M6	3
ER32SRK5X85JET2	ER32	5	10	19.8	85	70	15	21	M6	3
ER32SRK6X35JET2	ER32	6	11	14.7	35	25.5	18	24	M8	4
ER32SRK6X60JET2	ER32	6	11	17.3	60	45	18	24	M8	4
ER32SRK6X85JET2	ER32	6	11	20.8	85	69.5	18	26	M8	4
ER32SRK8X35JET2	ER32	8	14	18.8	35	33	25	31	M10	5
ER32SRK8X60JET2	ER32	8	14	20.4	60	45	25	31	M10	5
ER32SRK8X85JET2	ER32	8	14	23.2	85	65	25	31	M10	5
ER32SRK10X35JET2	ER32	10	16	20.8	35	34	30	35	M12	6
ER32SRK10X60JET2	ER32	10	16	22.4	60	44.5	30	36	M12	6
ER32SRK10X85JET2	ER32	10	16	23	85	49.5	30	36	M12	6
ER32SRK12X35JET2	ER32	12	20	24	35	28	32	-	-	-
ER32SRK12X60JET2	ER32	12	20	24	60	28	32	38	M14	6
ER32SRK12X85JET2	ER32	12	20	24	85	28	32	38	M14	6

TUNGSHRINK

IND SHRINKIN UNIT

SHRINKIN Induction heating unit for shrink tool chucking

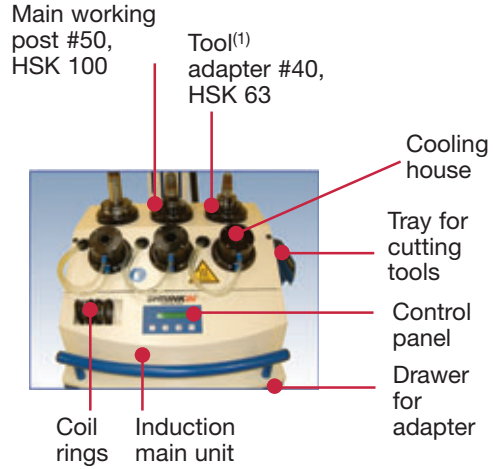

Inch
IND SHRINK IN UNIT USA

Machine
3-380-500V 50/60HZ

TUNGSHRINK

IND SHRINK START UNIT

SHRINKIN Induction heating unit for shrink tool chucking



Inch
IND SHRINK START UNIT USA

Machine
3-380-500V 50/60HZ

TUNGSHRINK

SHRINKIN UNIT V2

SHRINKIN Thermal shrink heating unit for shrink tool chucking

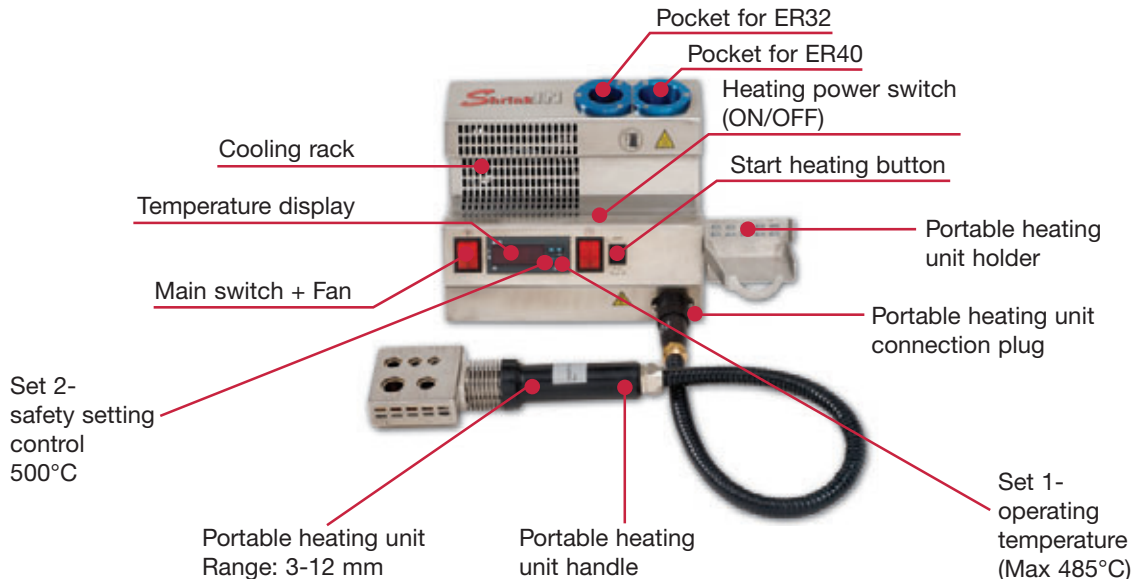

Inch
SHRINKIN UNIT V2 USA

Machine
220V 50/60HZ

TUNGSHRINK

SET ER-SRK

A set of ER collets with thermal shrink chucks and various bore sizes



Inch	Collet size	Qty	Range
SETER32SRKS6USA	32	6	0.187, 0.25, 0.312, 0.375, 0.437, 0.5
SETER32SRKM6USA	32	6	0.187, 0.25, 0.312, 0.375, 0.437, 0.5
SETER32SRKL6USA	32	6	0.187, 0.25, 0.312, 0.375, 0.437, 0.5

KIT SHRINKIN-V2 USA

The KIT includes a thermal shrink heating unit and 6 ER32 SRK thermal collets



Inch	Unit	Set of collet	Qty	Range
KITSHRINKINMV2USA	SHRINKIN UNIT V2	SET ER32 SRK M 6USA	6	4,5,6,8,10,12
KITSHRINKINSV2USA	SHRINKIN UNIT V2	SET ER32 SRK S 6USA	6	4,5,6,8,10,12



Tooling System

TUNGHOLD



TUNGSHOLD

PS OTT-BT

BT Pull Stud with OTT System Retention Knob

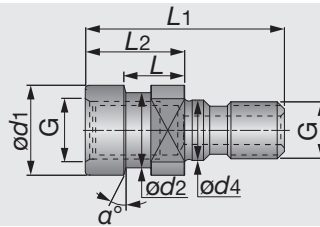

Metric	BT size	G	ød1	ød2	ød4	L	L1	L2	α°
PSOTTBT40M16	40	M16	25	21.1	17	16.6	56	28	15
PSOTTBT50M24	50	M24	39.3	32	25	13.4	65	25	15

TUNGSHOLD

NUT ER-TOP

DIN 6499 Nut for ER collet

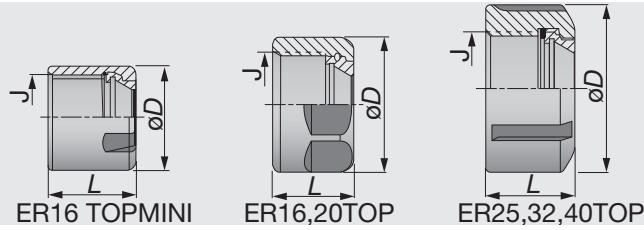

Metric	øD	L	J	Torque*
NUTER16TOP	28	17	M22X1.5	68.7
NUTER20TOP	34	19	M25X1.5	117.7
NUTER25TOP	42	20	M32X1.5	196.1
NUTER32TOP	50	22	M40X1.5	215.7
NUTER40TOP	63	25	M50X1.5	245.1

*Torque: Recommended torque (Nm) for clamping

TUNG HOLD

NUT ER-UM/MINI

Clamping Nuts for DIN 6499 ER Collet Chucks



Tooling System

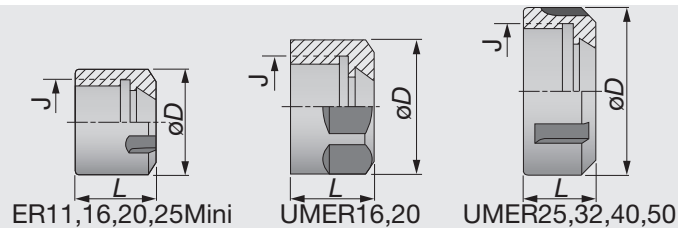

Metric	øD	L	J	Torque*
NUTER11GHS ⁽¹⁾	16	11.5	M13X0.75	-
NUTER11MINI	16	10.8	M13X0.75	29.4
NUTER11UM	19	11.3	M14X0.75	49
NUTER16MINI	22	18	M19X1.0	39.2
NUTER16UM	28	17	M22X1.5	68.7
NUTER20MINI	28	19	M24X1.0	78.5
NUTER20UM	34	19	M25X1.5	117.7
NUTER25MINI	35	20	M30X1.0	98
NUTER25UM	42	20	M32X1.5	196.1
NUTER32UM	50	22	M40X1.5	215.7
NUTER40UM	63	25	M50X1.5	245.1
NUTER50UM	78	35	M64X2.0	343.2

*Torque: Recommended torque (Nm) for clamping (1) To be used only for SpinJet spindles

TUNGBALANCE

NUT ER-BALANCE

BALANCIN Balanceable ER TOP DIN 6499 Nuts

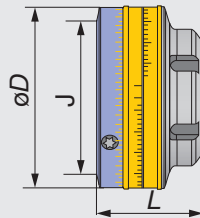

Metric	øD	L	J	Torque*
NUTER16TOPBIN	36	44	M22X1.5	68.7
NUTER25TOPBIN	37.5	58	M32X1.5	196.1
NUTER32TOPBIN	38	66	M40X1.5	215.7

*Torque: Recommended torque (Nm) for clamping

TUNGSHORT

NUT ER-SHORT

Nuts for TungShort ER Collet Chucks

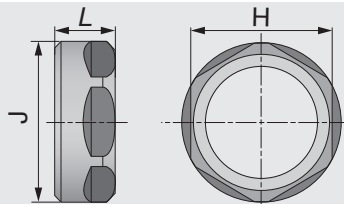

Metric	H	L	J	Torque*
NUTER20SHORT	22	10.7	M25X1.5	117.7
NUTER32SHORT	36	15	M40X1.5	215.7
NUTER40SHORT	46	16	M50X1.5	245.1

*Torque: Recommended torque (Nm) for clamping

TUNG HOLD



TUNG HOLD

WRENCH ER

Wrench for ER DIN 6499 Clamping Nut

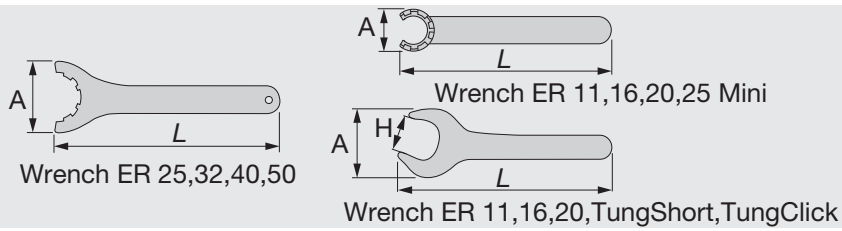

Metric	A	H	L
WRENCHER11SMS ⁽¹⁾	16	-	95
WRENCHER11MINI	16.8	-	95
WRENCHER11	32	17	95
WRENCHER16MINI	22.5	-	117
WRENCHER16	42.5	25	143
WRENCHER20MINI	28	-	128
WRENCHER20	53.5	30	172
WRENCHER25MINI	29	-	120
WRENCHER25	70	-	207
WRENCHER32	78	-	255
WRENCHER40	95	-	285
WRENCHER50	110	-	350
WRENCHER20SHORTRING22	48	22	260
WRENCHER32SHORT	75	36	303
WRENCHER40SHORT	94	46	378
WRENCHER32CLICKIN27	57	27	239
WRENCHER32CLICKIN32	67	32	273

(1) To be used only for SpinJet spindles

TUNG MAX

WRENCH

Wrench for TungMax collets

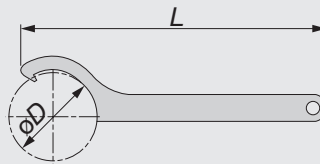

Metric	øD	L
WRENCHMAXIN20HOOK	26	205
WRENCHMAXIN32HOOK	68	240

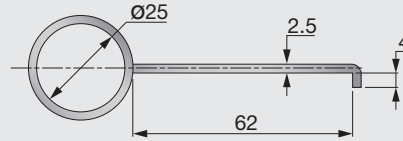

Metric

EXTRACTOR SC COLLETS

Collet

SC straight collets

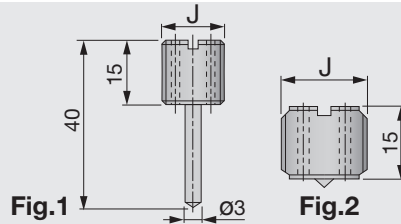

Fig.1

Fig.2

Metric	J	Fig
PRESETER-JET8X1	M8X1.0	2
PRESETER-JET8X1.25	M8X1.25	2
PRESETER-JET10X1.5	M10X1.5	2
PRESETER-JET12X1	M12X1.0	2
PRESETER-JET12X1.75L	M12X1.75	1
PRESETER-JET12X1.75	M12X1.75	2
PRESETER-JET14X1	M14X1.0	2
PRESETER-JET16X2	M16X2	2
PRESETER-JET16X2L	M16X2	1
PRESETER-JET18X1	M18X1.0	2
PRESETER-JET18X1.5	M18X1.5	2
PRESETER-JET18X1.5L	M18X1.5	1
PRESETER-JET22X1.5	M22X1.5	2
PRESETER-JET22X1.5L	M22X1.5	1
PRESETER-JET28X1.5	M28X1.5	2



TUNGMAX

Preset Screw

Preset Screw for TungMax chuck

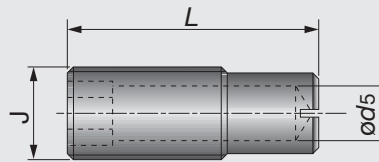

Metric	J	L	ød5	Key
PRESETMAXIN16X30	M16	30	8	8
PRESETMAXIN16X44	M16	44	8	8
PRESETMAXIN20X55	M20	55	12	12

TUNGHOLD

SCREW-SEM

Lock Screw for Shell Mill Holder

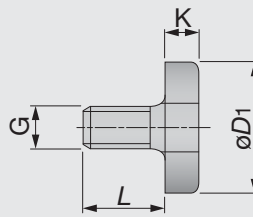

Metric	G	øD1	K	L
M8CLAMPSCREWSEM16	M8	20	6	16
M10CLAMPSCREWSEM22	M10	28	7	18
M12CLAMPSCREWSEM27	M12	35	8	22
M16CLAMPSCREWSEM32	M16	42	9	26
M20CLAMPSCREWSEM40	M20	52	10	30
M24CLAMPSCREWSEM50	M24	63	12	36

STANDARD CENTER BOLT

Inch	G	øD1	K	L	Torque
SCREW 1/4-28 SEM 1/2	1/4-28 UNF-2A	0.65	0.315	0.709	6
SCREW 3/8-24 SEM 3/4	3/8-24 UNF-2A	0.886	0.394	0.709	25
SCREW 1/2-20 SEM 1	1/2-20 UNF-2A	1.181	0.472	0.874	50
SCREW 5/8-18 SEM 1-1/4	5/8-18 UNF-2A	1.496	0.512	1.000	75
SCREW 3/4-16 SEM 1-1/2	3/4-16 UNF-2A	1.87	0.512	1.161	100
SCREW 1-14 SEM 2	1-14 UNS-2A	2.48	0.512	1.25	110

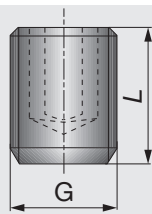

Metric	G	L	For dia
SRM6X10DIN1835B	M6	10	6
SRM8X10DIN1835-B	M8	10	8
SRM10X12DIN1835-B	M10	12	10
SRM12X16DIN1835-B	M12	16	12,14
SRM14X16DIN1835-B	M14	16	14,16
SRM16X16DIN1835-B	M16	16	20
SRM18X2X20DIN1835-B	M18X2	20	25,32
SRM20X2X20DIN1835-B	M20X2	20	40
SRM24X2X25DIN1835-B	M24X2	25	50
SRM16X10.3EMSHORT	M16	10.3	20
SRM18X2X10EMSHORT	M18X2	10	2

TUNGHOLD

PRESET SCREW

Preset Screw for EME/SRKIN Holder with coolant hole

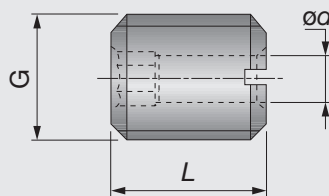

Metric	G	L	ød	For Shanks	Key
PRESETSCREWM6X20B	M6X1	20	2.5	EME/SRKIN	3
PRESETSCREWM8X20B	M8X1.25	20	3.5	EME/SRKIN	4
PRESETSCREWM10X18B	M10X1.5	18	4.5	EME/SRKIN	5
PRESETSCREWM12X18B	M12X1.75	18	5.5	EME/SRKIN	6
PRESETSCREWM16X20B	M16X2	20	7.5	EME/SRKIN	6
PRESETSCREWM16X25B	M16X2	25	7.5	SRKIN	6



TUNGHOLD

WRENCH SEMC

Wrench DIN 6368 for Face and COMBI Shell Endmill Holders

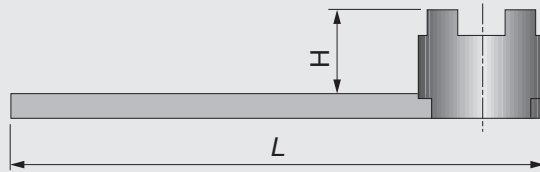

Metric	Clamping bore dia.	G	H	L
WRENCHM8SEMC16	16	M8	20	180
WRENCHM10SEMC22	22	M10	25	200
WRENCHM12SEMC27	25.4,27	M12	32	225
WRENCHM16SEMC32	31.75,32	M16	36	250
WRENCHM20SEMC40	38.1,40	M20	40	280
WRENCHM24SEMC50	50,50.8	M24	50	315

TUNGHOLD

DRIVING RING SEMC

Driving Ring DIN 6366/1 for COMBI Shell and Mill Holder

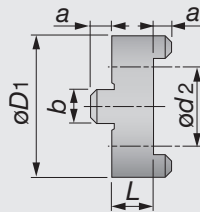

Metric	ød2	øD1	L	a	b
16D.RINGSEMC	16	32	10	8	5
22D.RINGSEMC	22	40	12	10	6
27D.RINGSEMC	27	48	12	12	6.3
32D.RINGSEMC	32	58	14	14	7
40D.RINGSEMC	40	70	14	16	8
50D.RINGSEMC	50	90	16	18	9

• Use's with "WRENCH SEMC"

TUNGHOLD

COOLING TUBE-HSK

Cooling Tube for HSK

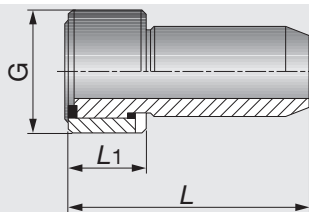

Metric	HSK size	L	L1	G
COOLINGTUBEHSKA40	40	29.1	7.5	M12X1
COOLINGTUBEHSKA50	50	32.7	9.5	M16X1
COOLINGTUBEHSKA63	63	36	11.5	M18X1
COOLINGTUBEHSKA80	80	36.6	13.5	M20X1.5
COOLINGTUBEHSKA100	100	43.6	15.5	M24X1.5

TUNGHOLD

WRENCH

Wrench for HSK cooling tube



Tooling System

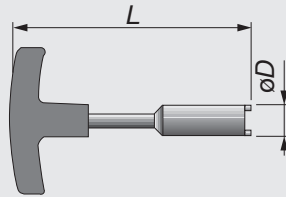

Metric	HSK size	øD	L
WRENCHCOOLTUBEHSK40	40	11	120
WRENCHCOOLTUBEHSK50	50	15	120
WRENCHCOOLTUBEHSK63	63	17	122
WRENCHCOOLTUBEHSK80	80	18.5	186
WRENCHCOOLTUBEHSK100	100	22	141

TUNGHOLD

TOOL CLAMP

Tool clamp fixture for ISO, DIN 69871, BT MAS-403 and CAT tool shanks

TUNGHOLD

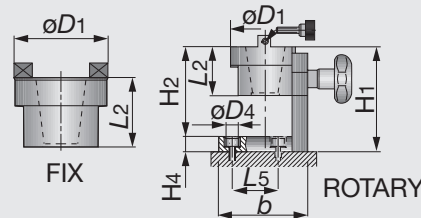

Metric	CSI	øD1	L2	H1	H2	H4	b	L5	øD4
TOOLCLAMP30ROTARY	ROTARY	70	56	128	109	19	104	40	12.5
TOOLCLAMP40ROTARY	ROTARY	82	56	128	109	19	104	40	12.5
TOOLCLAMP50ROTARY	ROTARY	103	71	170	151	19	144	85	12.5
TOOLCLAMP30FIX	FIX	82	58	-	-	-	-	-	-
TOOLCLAMP40FIX	FIX	82	58	-	-	-	-	-	-
TOOLCLAMP50FIX	FIX	103	71	-	-	-	-	-	-

TUNGHOLD

MULTI CLAMP (HSK)

Multi-clamp rotary fixture for HSK shanks

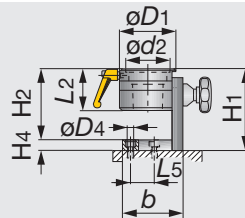

Metric	CSI	ød2	øD1	L2	H1	H2	H4	b	L5	øD4
MULTICLAMP32E/F	HSK A/C50	32	113.2	70	133	114	19	144	40	12.5
MULTICLAMP40E/F	HSK A/C63	40	113.2	70	133	114	19	144	40	12.5
MULTICLAMP50E/F	HSK A/C100	50	113.2	70	133	114	19	144	40	12.5
MULTICLAMP63E/F	HSK E/F32	63	113.2	70	133	114	19	144	40	12.5
MULTICLAMP50A/C	HSK E/F40	50	82	72	142	123	19	104	40	12.5
MULTICLAMP63A/C	HSK E/F50	63	95	72	142	123	19	104	40	12.5
MULTICLAMP100A/C	HSK E/F63	100	130	90	178	159	19	144	85	12.5

Complete Tightening & Rigid Clamping

Features

● LED illuminates at correct torque!

- When reaching the required clamping force, the LED will be activated.
- Enables the operator to set the insert correctly.
- Provides stable and correct clamping forces in any position.

● Available in various torque sizes!

- 5 Torx sizes are available.
- Hardened steel enhances the life of bit.

■ How to exchange a bit.

Unlock the used bit

- Pull the sleeve to loosen the bit



Lock the new bit

- After placing the bit in the correct position, push the sleeve to lock the bit.

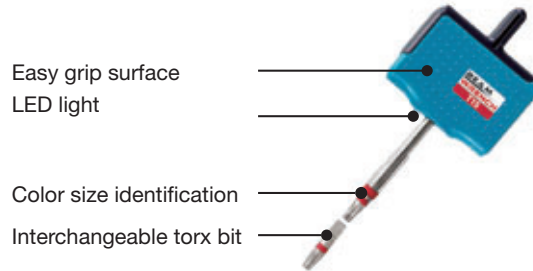



■ Attention when tightening:

- Hold the grip in a position, so the LED can be seen on the left side of bit shank. (See the picture below) Tighten the screw clockwise.



BEAMWRENCH set

	Shape	Designation	Torx Size	Torque (N·m)	Color
	Single flag	BW-SF6	T 6	0.6	White
		BW-SF7	T 7	0.9	Black
		BW-SF8	T 8	1.2	Green
		BW-SF9	T 9	1.4	Blue

	Shape	Designation	Torx Size	Torque (N·m)	Color
	Double flag	BW-DF8	T 8	1.2	Green
		BW-DF9	T 9	1.4	Blue
		BW-DF15	T 15	3.0	Red

BEAMWRENCH torx bits set

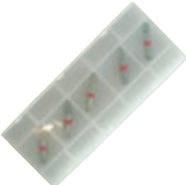
	Bit Designation	Torx Size	Torque (N·m)	Color
	BW-TX6SET5	T 6	0.6	White
	BW-TX7SET5	T 7	0.9	Black
	BW-TX8SET5	T 8	1.2	Green
	BW-TX9SET5	T 9	1.4	Blue
	BW-TX15SET5	T 15	3.0	Red

Purchase the Torx bit set with same color of your BeamWrench. Torx bits set: Packing Quantity = 5 pcs.

MEMO

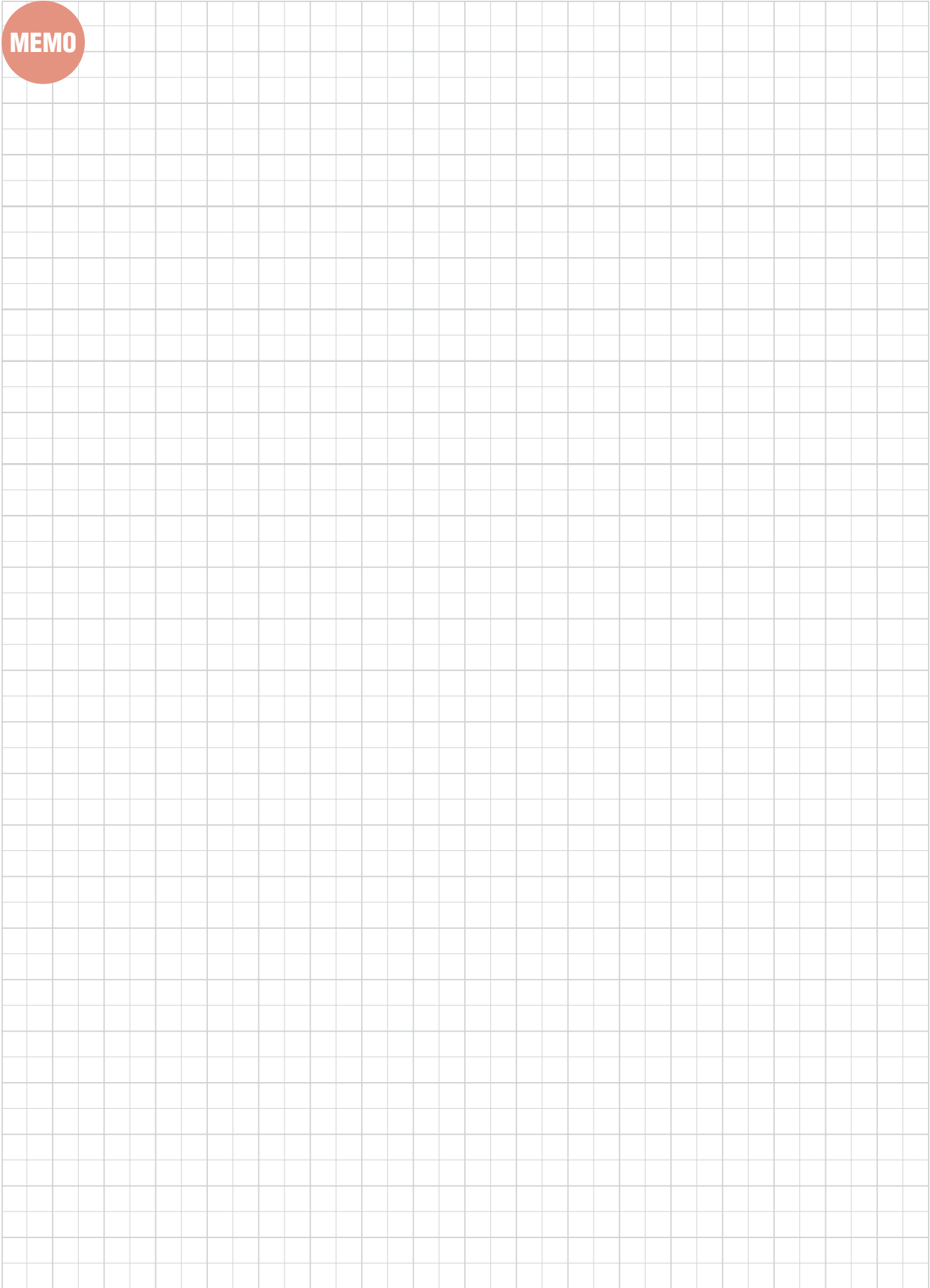

Tooling System

BEAMWRENCH

A person wearing a red high-visibility work jacket with reflective silver stripes and the brand name 'Tungaloy' on the chest is seated at a dark table. They are looking down at several sheets of technical drawings or blueprints spread out on the table. Their hands are positioned near a small, cylindrical metal component. To the right of the component is a rectangular metal tool or fixture. The scene is brightly lit, highlighting the red of the jacket and the metallic surfaces.

User's Guide

Parts for Tools G002

Technical Reference G029

Alphanumeric Index G084

User's Guide- Parts for Tools

Screws

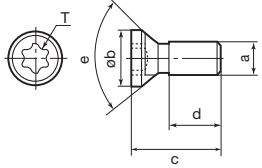
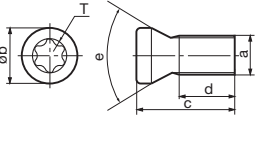
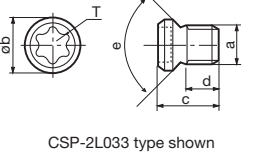
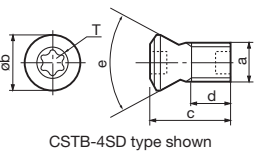
Shape	Designation	Dimension (in)					T / f	Torque (lbf.ft)		
		a	ob	c	d	e				
	CSTA-NO2	#2-56UNC	0.157	0.236	0.157	82°	T8	0.96		
	CSTA-NO2S			0.197	0.118					
	CSTA-NO2L			0.315	0.236					
	CSTA-NO3	#3-48UNC	0.169	0.276	0.157		T9	1.70		
	CSTA-NO5	#5-40UNC	0.197	0.315	0.197					
	CSTA-1.6	M1.6x0.35	0.098	0.123	0.033		T6	0.44		
	CSTA-4	M4x0.7	0.276	0.394	0.303					
	CSTA-5	M5x0.8	0.283	0.591	0.433		T15	2.58		
	CSTA-5S			0.472	0.315					
	CSTA-5SS			0.374	0.217					
	CSTA-5ST25	M5x0.8	0.280	0.472	0.315		T25	3.69		
	CSPA-5IP15			0.591	0.433				15IP	2.58
	CSPA-5SIP15			0.472	0.315					
	CSPA-5IP20	M5x0.8	0.280	0.591	0.433		20IP	3.69		
CSPA-5SIP20	0.472			0.315						
 <p>CSP-2L033 type shown</p>  <p>CSTB-4SD type shown</p>  <p>CSTC-4L type shown</p>	CSP-2L033	M2x0.157	0.102	0.130	0.073	88°	6IP	0.52		
	CSTB-2	M2x0.157	0.106	0.130	0.055	T6	0.52			
	CSTB-2L			0.205	0.130					
	CSTB-2L040			0.157	0.083					
	CSTB-2.2	M2.2x0.45	0.138	0.240	0.138	T7	0.74			
	CSTB-2.2L038			0.150	0.087					
	CSTB-2.2S			0.181	0.079					
	CSTB-2.2R	M2.2x0.45	0.122	0.240	0.146	T8	0.96			
	CSTB-2.5			0.236	0.134					
	CSTB-2.5L080			0.315	0.213					
	CSTB-2.5B	M2.5x0.45	0.138	0.217	0.102	T9	1.70			
	CSTB-2.5S			0.189	0.087					
	CSTB-3			0.315	0.177					
	CSTB-3L042	M3x0.5	0.161	0.165	0.028	T8	0.96			
	CSTB-3L050			0.197	0.079					
	CSTB-3L081			0.161	0.098					
	CSTB-3S	M3x0.5	0.217	0.492	0.157	T9	1.70			
	CSTB-3.5ST			0.205	0.122					
	CSTB-3.5H			0.217	0.169					
	CSTB-3.5	M3.5x0.6	0.256	0.394	0.217	T15	2.58			
	CSTB-3.5T			0.335	0.157					
	CSTB-3.5TS			0.185	0.193					
	CSTB-3.5D	M3.5x0.6	0.189	0.453	0.276	T20	3.69			
	CSTB-3.5L110			0.189	0.256					
	CSTB-3.5L115			0.189	0.256					
	CSTB-3.5L115-S	M3.5x0.6	0.217	0.433	0.295	T9	1.70			
	CSTB-3.5L			0.492	0.331					
	CSTB-4			0.449	0.291					
	CSTB-4L060	M4x0.7	0.217	0.236	0.079	T15	2.58			
	CSTB-4L085			0.334	0.137					
	CSTB-4L090			0.224	0.217					
	CSTB-4L115-S	M4x0.7	0.217	0.453	0.256	T15	2.58			
	CSTB-4S			0.217	0.315					
	CSTB-4ST			0.252	0.579			0.157		
	CSTB-4SD	M4x0.7	0.217	0.315	0.157	T8	0.96			
	CSTB-4M	M4x0.7	0.217	0.374	0.217					
	CSTB-4F	M4x0.5	0.276	0.579	0.343	T15	2.58			
	CSTB-4TS	M4x0.7	0.256	0.354	0.177					
	CSTB-5	M5x0.8	0.276	0.472	0.295	T20	3.69			
	CSTB-5S			0.374	0.197					
	CSTB-5L105			0.413	0.240					
	CSTB-5L120	M5x0.8	0.283	0.472	0.256	T20	3.69			
	CSTB-5L159			0.626	0.441					
	CSTB-5L163-S			0.272	0.445					
	CSTC-4L055DR	M4x0.5	0.213	0.217	0.079	44°	T8/T10	0.96/1.84		
	CSTC-4L055DL	M4x0.5	0.213	0.217	0.079					
	CSTC-4L100DR	M4x0.7	0.213	0.394	0.234					
	CSTC-4L100DL	M4x0.7	0.213	0.394	0.234					
CSPB-2L043	M2x0.157	0.106	0.169	0.096	60°	6IP	0.52			
CSPB-2H			0.102	0.134				0.063		

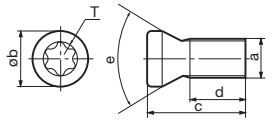
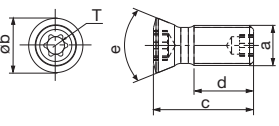

User's Guide- Parts for Tools

Screws

Shape	Designation	Dimension (in)					Torque (lb.ft)	
		a	øb	c	d	e		
  SCREW TORX M4 L=9.5MM type shown	CSPB-2.2	M2.2x0.45	0.118	0.236	0.154	60°	7IP	0.74
	CSPB-2.2SH			0.157	0.079			0.81
	CSPB-2.5	M2.5x0.45	0.138	0.236	0.138		8IP	0.96
	CSPB-2.5S			0.165	0.067			
	CSPB-2.5SH	M3.5x0.6	0.205	0.205	0.130		7IP	0.81
	CSPB-3.5			0.354	0.220			
	CSPB-3.5S	M4x0.7	0.217	0.256	0.122		15IP	2.58
	CSPB-4			0.457	0.291			
	CSPB-4S	M5x0.8	0.276	0.323	0.157		20IP	3.69
	CSPB-5			0.472	0.295			
	VX040024A	M4	0.215	0.354	0.236	60°	T15	3.32
	VX040028A	M4	0.205	0.382	0.185	44°	T15	3.32
	SR14-500/L5.1	M4	0.217	0.201	0.091	60°	T15	2.58
	SR14-500-L7.0	M4	0.217	0.276	0.165		T15	2.58
	SR14-562	M3.5	0.189	0.344	0.219		T10	2.58
	SR14-562/S	M3.5	0.189	0.256	0.130		T10	2.58
	SR14-591	M5x0.8	0.260	0.531	0.299		T20	3.69
	SR34-508	M2.2x0.45	0.124	0.181	0.105		T7	0.66
	SR34-514	M2.5x0.45	0.130	0.205	0.126		T7	0.66
	SR76-943	M6	0.378	0.787	0.394		90°	T20
SR76-961	M5	0.260	0.531	0.286	61°		T15	2.58
SR76-963	M5	0.339	0.787	0.378	91°		T15	2.58
SR114-018-L3.40	M2.5	0.142	0.132	0.079	56°	T6	0.52	
SM40-143-H0	M4X0.7	0.220	0.563	0.331	61°	T15	2.58	
TS25F080A	M2.25X0.35	0.146	0.272	0.083	60°	T8	0.96	
TS30F100A	M3X0.35	0.181	0.327	0.087		T10	1.84	
TS40085I/HG	M4	0.224	0.335	0.177		T15	2.58	
TS40093I/HG	M4	0.224	0.366	0.169		T15	2.58	
TS40B100I	M4	0.236	0.394	0.236	R3.0	T15	2.58	
TS40F120A	M4X0.5	0.236	0.417	0.118	60°	T15	2.58	
TS45120I	M4.5	0.272	0.472	0.295	R3.5	T20	3.69	
TS50115I	M5	0.276	0.447	0.252	60°	T20	3.69	
TS50F160A	M5X0.5	0.276	0.547	0.138		T20	3.69	
TS60F200A	M6X0.75	0.323	0.657	0.177		T20	5.16	
TS70F250A	M7X0.75	0.394	0.827	0.220		T25	5.16	
TS80F300A	M8X1.0	0.472	0.984	0.287		T30	7.38	
(Steel)	CSPD-1.8S	M1.8x0.35	0.094	0.130	0.055	55°	6IP	0.52
(Steel)	CSTD-3T	M3x0.5	0.169	0.276	0.177		T10	1.84
(Steel)	CSPD-3						0.165	10IP
(Steel)	CSTB-4.5L110P	M4.5X0.75	0.206	0.461	0.276	56°	T15	2.58
(Steel)	SRM5X0.8IP20X+ACROLYTE	M5X0.8	0.362	0.591	0.386	70°	20IP	5.53
(Steel)	CSTC-2	M2x0.4	0.122	0.201	-	-	T6	0.52
(Steel)	CSTR-4L100	M4x0.7	0.224	0.394	0.217	-	T15	2.58
(Steel)	SR16-212-01397	M5x0.8	0.252	0.492	0.268	43°	T20/T10	1.84
(Steel)	SR16-212-01397L							
(Steel)	CST-3.5	M3.5X0.6	0.236	0.189	-	90°	T9	1.70
(Steel)	CST-3.5S			0.138	-			
(Steel)	CST-5	M5x0.8	0.394	0.709	0.512		T25	3.69
(Steel)	CST-5S			0.472	0.276			
(Steel)	CSTF-2L055-S	M2x0.4	0.106	0.217	0.150		T6	0.52

User's Guide- Parts for Tools

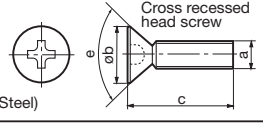
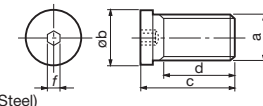
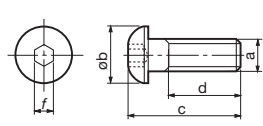
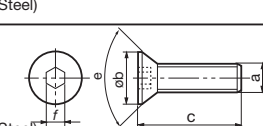
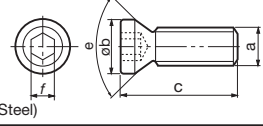
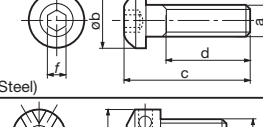
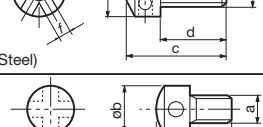
Screws

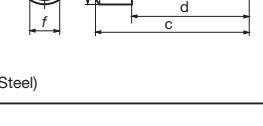
Shape	Designation	Dimension (in)						Torque (lbf-ft)	
		a	øb	c	d	T / f	e		
 <p>Cross recessed head screw</p> <p>(Steel)</p>	SM2.5x0.45x8	M2.5x0.45	0.197	0.315		0.102	90°	-	
	SM2.5x0.5x8	M2.5x0.5	0.197	0.315		0.102	90°	-	
	SM3x0.5x6	M3x0.5	0.236	0.315		0.138	90°	-	
	SM3x0.5x8							-	
	SM3x0.5x10							-	
 <p>(Steel)</p>	MSP-5	M5x0.8	0.240	0.311	0.193	0.079		1.11	
	MSP-6.3	M6.3x1	0.303	0.500	0.390	0.098		2.21	
 <p>(Steel)</p>	BHM3-8	M3x0.5	0.217	0.394	0.315	0.079		1.11	
	BHM4-8	M4x0.7	0.276	0.417	0.394	0.098		1.62	
	BHM4-10								
	BHM5-14	M5x0.8	0.354	0.693	0.551	0.118		2.21	
	BHM6-20-A	M6x1.0	0.413	0.945	0.787	0.157		3.69	
	BHM8-25U	M8	0.551	0.045	0.984	0.198		6.27	
	BHM8-30U								
CSHM-3-8	M3	0.236	0.315		0.079	90°	1.11		
 <p>(Steel)</p>	CSHB-4-A	M4	0.217	0.433		T15	60°	1.48	
	CSHB-6	M6	0.335	0.748	-	0.157	60°	3.69	
	CSHB-6-A	M6	0.335	0.748				3.69	
 <p>(Steel)</p>	RT-1	M6	0.394	0.886	0.551	0.157		3.69	
	RT-2	M8	0.512	1.220	0.787	0.197		6.27	
 <p>(Steel)</p>	ASM6	M6	0.394	0.709	0.472	0.118		-	
	AJM5F	M5x0.5	0.354	0.512	0.315	0.079		-	
	AJM5	M5x0.8	0.354	0.512	0.315	0.079		-	
 <p>(Steel)</p>	ASM34S	M3	0.189	0.315	0.197	0.079		-	
	ASM34L			0.433	0.315			-	
	ASM54	M5x0.8	0.354	0.551	0.354	0.118		-	
 <p>(Steel)</p>	CHHM3.5-10	M3.5x0.6	0.236	0.531	0.394	0.118		2.21	
	CHHM4-10	M4x0.7	0.276	0.551		0.157		3.69	
	CHHM5-14	M5x0.8	0.335	0.748	0.551				
	CHHM5-18			0.906	0.709				
	CHHM6-15	M6	0.394	-	0.787	0.197		6.27	
	CHHM6-20			1.220	0.984				
 <p>Hex. socket head screw (JISB1176)</p> <p>(Steel)</p>	CM3X0.5X6	M3x0.5	0.217	0.354	0.236	0.098		1.62	
	CM3X0.5X10			0.512	0.394				
	CM4X0.7X10			0.551					
	CM4X0.7X12	M4x0.7	0.276	0.630	0.472	0.118		2.21	
	CM4X0.7X14				0.709				0.551
	CM4X0.7X15				0.748				0.591
	CM4X0.7X20				0.945				0.787
	CM4X0.7X20-M0-A		0.236	0.945	0.787	0.157		3.69	
	CM5X0.8X8	M5x0.8	0.335	0.512	0.315				
	CM5X0.8X10-A			0.591	0.394				
	CM5X0.8X12			0.669	0.472				
	CM5X0.8X12-A			0.669	0.472				
	CM5X0.8X14			0.709	0.551				
	CM5X0.8X16			0.827	0.630				
	CM5X0.8X16-A			0.827	0.630				
	CM5X0.8X18			0.906	0.709				
	CM5X0.8X20-A			0.984	0.787				
CM5X0.8X25-A	1.180			0.984					
CM5X15	M5		0.787	0.591					

User's Guide- Parts for Tools

Screws

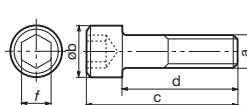
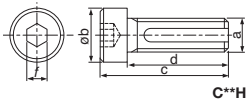
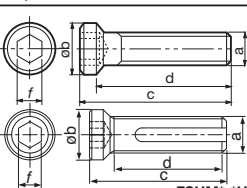
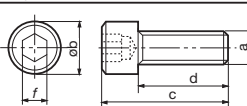
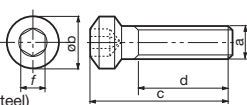
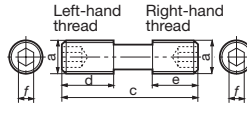
Shape	Designation	Dimension (in)							Torque (lbf-ft)	
		a	øb	c	d	f	e	T / f		
 <p>Hex. socket head screw (JISB1176)</p>  <p>C**H</p>	CM6X1X16-A	M6x1.0	0.394	0.866	0.630	0.197			6.27	
	CM6X1X20-A			1.020	0.787					
	CM6X1X25-A			1.220	0.984					
	CM6X1.0X40-A			1.810	1.580					
	CM6X10	M6		0.630	0.394					
	CM6X15			0.827	0.591					
	CM6X16			0.866	0.630					
	CM6X20			1.020	0.787					
	CM6X25	1.220	0.984							
	CM6X30-S	M6x1.0	0.394	1.410	1.100					
	CM8X1.25X20-A	M8x1.25	0.512	1.100	0.787	0.236				18.44
	CM8X1.25X25-A			1.300	0.984					
	CM8X30H			1.420	1.180					
	CM10X30	M10x1.5	0.630	1.180	0.787	0.315				29.50
	CM10X30H		0.630	1.500	1.180	0.236			29.50	
	CM12X30H	M12x1.75	0.709	1.580	1.180	0.315			51.63	
	CM16X40H	M16x2	0.945	2.130	1.580	0.394			73.75	
	CM16x75	M16	0.945	2.953	2.008	0.551			73.75	
	CM16x120	M16	0.945	4.727	3.780	0.551			73.75	
	CM16x140	M16	0.945	5.512	4.567	0.551			73.75	
	CM20x80	M20	1.181	3.150	1.969	0.669			110.63	
	CM20x120	M20	1.181	4.727	3.543	0.669			110.63	
	CM20x150	M20	1.181	5.906	4.724	0.669			110.63	
	CAP-CM12x1.75x50	M12	0.709	1.969	1.496	0.394			51.63	
	CAP-CM16X2.0X55	M16	0.945	2.165	1.535	0.551			29.50	
	CAP-CM20X2.5X50	M20	1.181	1.969	1.181	0.669			73.75	
	C0.375X1.125H	3/8-24UNF	0.562	1.500	1.125	0.219			25.81	
	C0.500X1.375H	1/2-20UNF	0.750	1.876	1.375	0.313			51.63	
SD06-A3	M10x1.5	0.630	2.756	2.362	0.315			29.50		
SRM6X16DIN912-12.9	M6x1	0.630	2.756	2.362	0.197					
SD08-98	M12x1.75	0.709	3.031	2.559	0.394			51.63		
LHM12x1.75x30-C	M12	0.709	1.453	1.181	0.315			51.63		
FCS3	M3x0.5	0.217	0.630	0.472	0.098					
FCS6	M6x1	0.394	1.024	0.787	0.197					
(Steel)										
 <p>FSHM*-*H</p>	FSHM8-30	M8x1.25	0.433	1.180	1.060	0.197			18.44	
	FSHM8-30H								18.44	
	FSHM10-40	M10	0.551	1.580	1.440	0.236			29.50	
	FSHM10-40H								29.50	
(Steel)										
 <p>SHCM4-*</p>	SHCM4-10	M4x0.7	0.236	0.551	0.394	0.118			2.21	
	SHCM4-12			0.630	0.472					
	SHCM4-16			0.787	0.630					
(Steel)										
 <p>CTS-M6</p>	CTS-M6	M6x1	0.394	0.984	0.646	0.157			3.69	
(Steel)										
 <p>Left-hand thread Right-hand thread</p>	MCS520-2.5	M5x0.8		0.787	0.276		0.236	0.098	2.21	
	MCS620-3	M6x1					0.276	0.118	4.43	
	MCS625-3				0.315					
	MCS825-4	M8x1			0.984	0.492	0.256	0.157	5.90	
	MCS828-4			1.104	0.472	0.413				
	NDS-8A			1.18	0.453	0.453				
	NDS-8S	M8x1.25		0.787	0.315	0.315				
	RSRGR5M40	M4		0.354	0.144	0.164	T8			
	SR PS 118-0273	M10		1.575	0.650	0.591	0.197	29.50		
	SR 5/16-32UNEF_3/8-24UNF	5/16-32UNEF - 2A		1.260	0.394	0.453	0.156			
(Steel)										

User's Guide- Parts for Tools

Screws

Shape	Designation	Dimension (in)							Torque (lbf-ft)	
		a	b	øb	c	d	e	T / f		
<p>Left-hand thread Right-hand thread</p> <p>(Steel)</p>	DS-6T	M6			0.591	0.236	0.236		2.58	
	DS-6P	M6x1			0.827	0.276	0.118	15IP	4.43	
	FDS-8ST	M8x1			0.787	0.315	0.315	T27	7.38	
	FDS-8ST-18				0.709		0.236			
<p>Left-hand thread Right-hand thread</p> <p>(Steel)</p>	DS-6	M6x1			0.591	0.236	0.236	0.118	4.43	
	DS-8	M8x1.25			0.630	0.276	0.276	0.157	5.90	
	DS-8S				0.512	0.217	0.217			
	DS-10	M10x1.5			1.020	0.394	0.472	0.197	5.90	
	FDS-6Z	M6x0.75			0.807		0.217	0.118	4.43	
	FDS-8	M8x1			1.020	0.315	0.394	0.157	5.90	
	FDS-8S				0.787		0.315			
FDS-8SS				0.728	0.256					
<p>(Steel)</p>	SS100	1/4-20UNC		0.367	0.983	0.750				
	S-412	10-32UNF		0.306	0.927	0.750				
<p>(Steel)</p>	SHM8x1.25x35-C	M8		0.512	1.693	0.906	0.315	0.236	18.44	
	SHM10x1.5x30-C	M10		0.630	1.575	0.669	0.394	0.315	29.50	
	SHM16x2x35-C	M16		0.945	2.008	0.709	0.630	0.551	73.75	
	SHM20x2.5x40-C	M20		1.181	2.283	0.787	0.709	0.669	110.63	
<p>Hex. socket screw (Flat end)(JISB1177)</p> <p>(Steel)</p>	SSHM2.5-3	M2.5			0.118			0.059	0.74	
	SSHM3-3	M3			0.118					
	SSHM3-4				0.236					
	SSHM3-6				0.157					
	SSHM4-4	M4			0.157			0.079	1.11	
	SSHM4-5				0.197					
	SSHM4-6				0.236					
	SSHM4-8				0.315					
	SSHM4-10				0.394					
	SSHM4-14				0.551					
	SSHM5-6	M5			0.236			0.098	1.48	
	SSHM5-10				0.394					
	SSHM5-16				0.630					
	SSHM6-12	M6			0.472			0.118	2.21	
	SSHM6-16				0.630					
	SSHM6-18				0.709					
	SSHM6-20				0.787					
	SSHM8-8	M8			0.315			0.157	3.69	
	SSHM8-10				0.394					
SSHM8-12				0.472						
SSHM8-14				0.551						
SSHM8-16				0.630						
SSHM8-18				0.709						
<p>Hex. socket screw (Cylindrical end) (JISB1177)</p> <p>(Steel)</p>	M5x7	M5			0.276		-	0.098	1.48	
	M5x8				0.138	0.315	0.098			-
	M5x10				0.394					-
	M6x30	M6		0.157	1.180	0.118	-	0.118	2.21	
<p>(Steel)</p>	JDS-3525	M3.5x0.35	M2.5x0.45		0.295	0.118	0.098	0.079	0.74	
	JDS-5040	M5x0.5	M4x0.7		0.394	0.157	0.157	0.098	0.74	
<p>LCS2 has a hex. socket in threaded end only.</p> <p>(Steel)</p>	LCS2	M5		0.197	0.551			0.079	1.11	
	LCS3	M6			0.236	0.669	0.256		0.098	1.48
	LCS3B				0.591					
	LCS4	M8				0.827	0.378	0.118	2.21	
	LCS4K				0.315	0.689				0.256
	LCS4CA					0.984	0.335			
	LCS5				0.807					
	LCS5CA									
	LCS6	M10		0.386	1.070	0.390		0.157	3.69	
LCS8	M12		0.465	0.142	0.504		0.197	5.90		
LCS8C	M10		0.396	1.190	0.524		0.157	3.69		

User's Guide- Parts for Tools

Screws

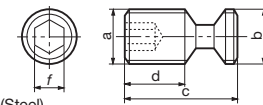
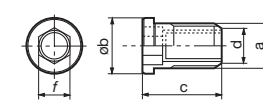
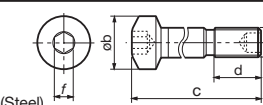
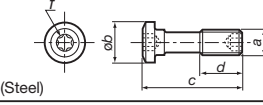
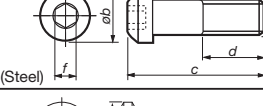
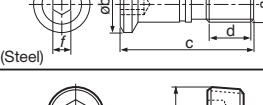
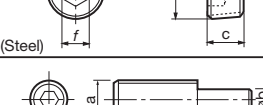
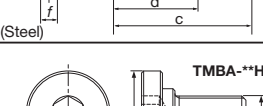
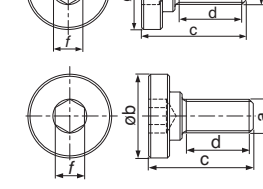
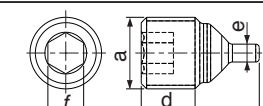
Shape	Designation	Dimension (in)							Torque (lb-ft)
		a	b	øb	c	d	e	T / f	
 (Steel)	LCS22	M5	M5		0.394	0.185		0.079	1.11
	LCS22A	M6	M6		0.421				
	LCS23A	M5	M5		0.516	0.201		0.098	1.48
	LCS33	M5	M5		0.472	0.244		0.079	1.11
	LCS43	M6	M6		0.531	0.287		0.098	1.48
 (Steel)	DTS5-3.5	M5		0.248	0.341	M3.5		0.138	2.95
	DTS5-3.5SS		0.268						
	DTS5-3.5S		0.276						
	DTS6-4	M6		0.303	0.402	M4		0.157	3.69
	DTS6-4.5			0.295	0.394	M4.5		0.177	3.69
 (Steel)	DLCS33	M5		0.354	1.240	0.394		0.118	2.21
	DLCS43	M6		0.472	1.340	0.374		0.157	3.69
	DLCS54	M8x1		0.551	1.610	0.433			5.16
	DLCS64	M10x1		0.630	1.970	0.591		0.197	5.90
 (Steel)	ACS-5W	M5		0.315	0.787	0.335		T15	2.95
	ACS-6W	M6		0.394	1.024	0.476		T20	4.72
 (Steel)	ACS3	M5x0.8		0.295	1.010	12-15 (mm)		0.118	2.95
	ACS4	M6x1		0.354	1.090	14-17 (mm)		0.157	5.16
 (Steel)	WCS3	M6		0.374	0.886	0.315		3	2.21
 (Steel)	PT1/4GN			0.519	0.394	-		0.236	7.01
	1/8-28			0.383	0.276	-		0.197	5.90
 (Steel)	LS-8	M8		0.236	0.236	0.787		0.157	3.69
 (Steel)	TMBA-M10	M10x1.5		1.063	1.181	0.827		0.315	29.50
	TMBA-M12	M12x1.75		1.299	1.417	1.024		0.394	51.63
	TMBA-M12H	M12x1.75			1.358				
	TMBA-M16	M16x2		1.575	1.969	1.575		0.551	73.75
	TMBA-M16H	M16x2							
	TMBA-M20	M20x2.5		1.969	2.205	1.654		0.669	110.63
	TMBA-M20H	M20x2.5							
	TMBA-M24	M24x3		2.559	2.717	2.165		0.748	110.63
	TMBA-M24H	M24x3							
	TMBA-0.500H	1/2-20UNF		1.299	1.335	1.000		0.313	51.63
	TMBA-0.750H	3/4-16UNF		1.969	2.294	1.861		0.500	110.63
TMBA-0.750S.375H	3/4-16UNF		1.875	1.700	1.310		0.375	75.00	
 (Steel)	SR-10400611	M4X0.5			0.260	0.118	0.039	0.079	

User's Guide- Parts for Tools

Shims

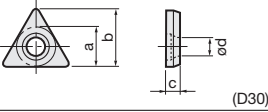
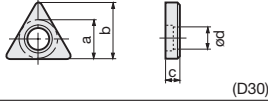
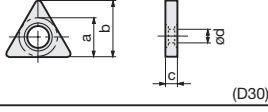
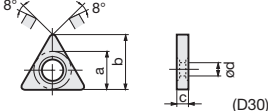
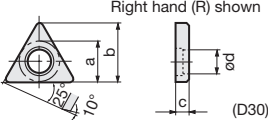
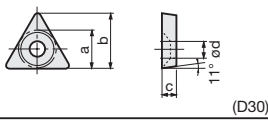
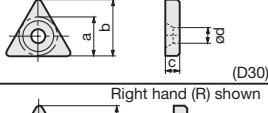
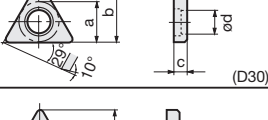
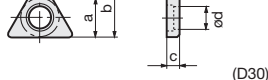
Shape	Designation	Dimension (in)			
		a	b	c	ød
 (D30)	AST322	0.366	0.520	0.126	0.173
	AST422	0.429	0.709	0.126	0.173
 (D30)	MST-322	0.358	0.508	0.128	0.228
	MST-432	0.492	0.705	0.189	0.287
	MST-533	0.614	0.874		0.382
	MST-644	0.740	1.050	0.252	0.445
 (D30)	LST317	0.366	0.520	0.106	0.197
	LST42	0.492	0.709	0.126	0.264
	LST53	0.618	0.878	0.189	0.303
	LST42K	0.429	0.614	0.126	0.264
 (D30)	LST317CA	0.366	0.520	0.106	0.197
	LST42CA	0.492	0.709	0.126	0.264
 (D30)	ELST42	0.453	0.650	0.126	0.256
	ELST317				
	ELST317BR				
	ELST317BL				
 (D30)	PAT-32	0.323	0.461	0.126	0.138
	PAT-53*	0.528	0.780	0.189	0.197
 (D30)	NAT-32	0.374	0.528	0.126	0.138
	NAT-42E	0.488			
 (D30)	LST317BR	0.366	0.520	0.106	0.197
	LST317BL				
 (D30)	SST32	0.335	0.469	0.126	0.213

Note: * marked shims are made of steel.

User's Guide- Parts for Tools

Shims

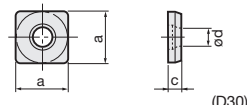
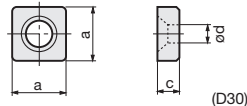
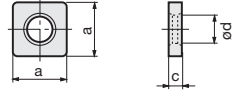
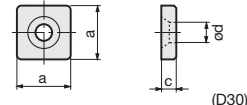
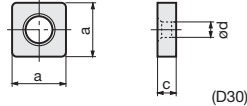
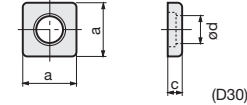
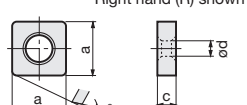
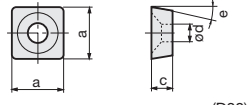
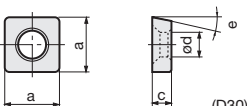
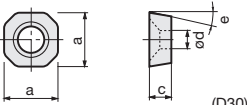
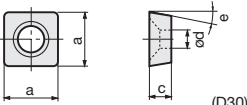
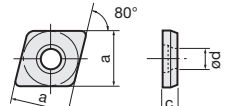
Shape	Designation	Dimension (in)				
		a	c	ød	e	
	ASS422	0.492	0.126	0.173		
	CS44-A	0.492	0.185			
	ASS533	0.618	0.189	0.217		
	ASS634	0.744				
	ELSS32	0.335	0.126	0.193		
	LSS33	0.366	0.169	0.197		
	ELSS42	0.461	0.126	0.256		
	LSS42	0.492	0.126	0.264		
	ELSS53	0.579	0.189	0.315		
	LSS53	0.618		0.303		
	ELSS63	0.705				
	LSS63	0.744		0.382		
	ELSS84	0.953	0.252	0.508		
	LSS84	0.992	0.252	0.516		
	NAS-42	0.500	0.126	0.138		
	NAS-04	1.240	0.252	0.358		
	MSS-432	0.492	0.126	0.138		
	MSS-442		0.252	0.358		
	SSS32	0.335	0.126	0.213		
	LSS42BR	0.492	0.126	0.264		
	LSS42BL					
	PAS-32	0.323	0.126	0.118	11°	
	PAS-42	0.449		0.138	11°	
	PAS-63*	0.669	0.189	0.197	10°	
	LSS42CA	0.492	0.126	0.264	8°	
	LSS53CA	0.618	0.189	0.303	10°	
	FSSA1102	0.457	0.079	0.217	13°	
	FSSP1102	0.433	0.079	0.217	17°	
	ASC322	0.366	0.126	0.173		
	ASC422	0.492	0.126	0.173		
	ASC533	0.618	0.189	0.217		
	ASC634	0.744				
	CC44-A	0.492	0.185			

Note: * marked shims are made of steel.

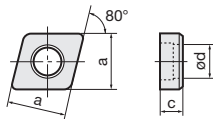
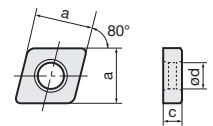
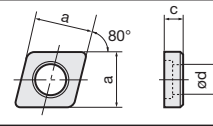
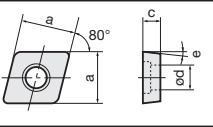
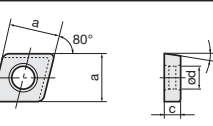
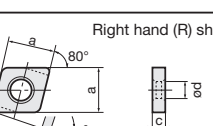
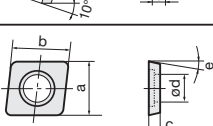
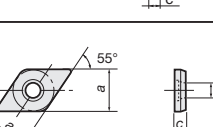
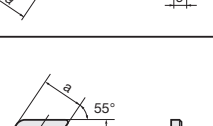
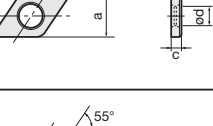
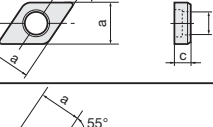
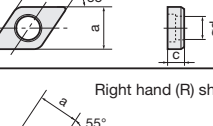

User's Guide- Parts for Tools

Shims

Shape	Designation	Dimension (in)				
		a	b	c	ød	e
 (D30)	MSC-432	0.492		0.189	0.287	
	MSC-442			0.252		
	MSC-533	0.614		0.189	0.382	
	MSC-543			0.252		
	MSC-634	0.740			0.445	
 (D30)	ELSC32	0.335	0.126	0.244		
	LSC42	0.492		0.256		
	ELSC42	0.461	0.189			0.303
	LSC53	0.618		0.319		
	ELSC53	0.579	0.382			
	ELSC63	0.705		0.106		
	LSC63	0.744	0.197			
	LSC317	0.366				
 (D30)	SSC32	0.335		0.126	0.213	
	SSC4T3	0.449		0.157	0.260	
 (D30)	SSC4T3-P	0.449		0.157	0.260	5°
	SSC54-P	0.528				5°
 (D30)	LSC42CA	0.492		0.126	0.264	8°
	LSC53CA	0.618		0.189	0.303	10°
 (D30)	LSC42BR	0.492		0.126	0.264	
	LSC42BL					
 (D30)	ZSA1102	0.413	0.433	0.079	0.216	11°
	ZSA1502	0.614	0.488		0.236	11°
 (D30)	ASD322	0.366		0.126	0.173	
	ASD423	0.492		0.126	0.173	
	ASD432	0.492		0.189	0.173	
	CD44-A	0.492		0.185		
 (D30)	ELSD32	0.335		0.126	0.193	
	ELSD42	0.461			0.256	
	LSD42	0.492		0.189	0.264	
	LSD42A					
	LSD43					
LSD43A						
 (D30)	MSD-322	0.366		0.126	0.228	
	MSD-432	0.492		0.189	0.287	
	MSD-442			0.252		
 (D30)	SSD32	0.335		0.126	0.213	
 (D30)	ELSD317BR	0.335		0.106	0.193	
	ELSD317BL					
	LSD42BR	0.492		0.126	0.264	
	LSD42BL					

User's Guide- Parts for Tools

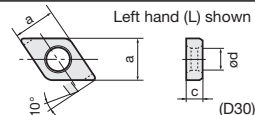
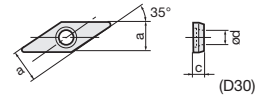
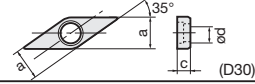
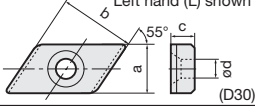
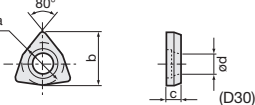
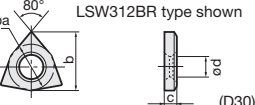
Shims

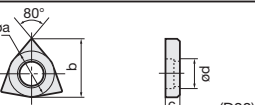
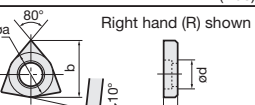
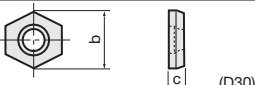
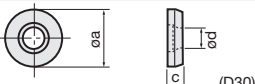
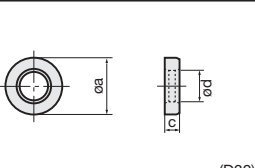
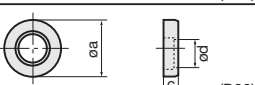
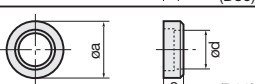
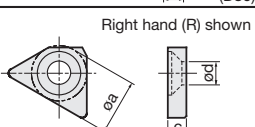
Shape	Designation	Dimension (in)				
		a	øa	b	c	ød
	LSZ42BR	0.492			0.126	0.264
	LSZ42BL					
	ASV222	0.274			0.125	0.130
	ASV322	0.366			0.126	0.173
	CV34-A	0.366			0.185	
	LSV212	0.281			0.087	0.195
	MSV-322	0.365			0.126	0.228
	SSV32	0.331				0.213
	SSV42	0.433				0.248
	CSK54R	0.370		0.583	0.189	0.138
	CSK54L					
	ASW322		0.367	0.453	0.126	0.173
	ASW422		0.492	0.598		
	LSW312		0.367	0.453	0.106	0.197
	LSW42		0.492	0.610	0.126	0.264
	LSW312BR		0.367	0.453	0.106	0.197
	LSW312BL					
	MSW-432		0.504	0.622	0.189	0.287
	MSW-533		0.630	0.776		0.382
	MSW-633		0.756	0.933		0.445
	MSW-432BR		0.504	0.622	0.189	0.287
	MSW-432BL					
	CH44-A			0.492	0.185	
	ASR420		0.492		0.126	0.173
	LSR32		0.350		0.126	0.197
	LSR32C		0.331			
	LSR42		0.476			
	LSR42C		0.390		0.189	0.264
	LSR53C		0.551			0.197
	LSR63C		0.677			0.323
	MSR-43		0.492		0.252	0.382
	MSR-44				0.189	0.287
	SSR32		0.343		0.125	0.205
	G16EL/IR		0.374	-	0.126	0.213
	G16ER/IL				0.126	
	G16EL/IR-DT				0.157	
	G16ER/IL-DT				0.157	

User's Guide- Parts for Tools

Shims

Shape	Designation	Dimension (in)			
		øa	ℓ	Lead angle	
	AE16-4DT	0.374	0.213	4°	
	AE16-3DT		0.213	3°	
	AE16-2DT		0.213	2°	
	A16-1DT		0.213	1°	
	AE16-0DT		0.213	0°	
	AE16-99DT		0.213	-1°	
	AE16-98DT		0.213	-2°	
	AE16-4		0.157	4°	
	AE16-3		0.157	3°	
	AE16-2		0.157	2°	
	A16-1		0.169	1°	
	AE16-0		0.157	0°	
	AE16-99		0.157	-1°	
	AE16-98		0.157	-2°	
	AN16-4DT		0.374	0.213	4°
	AN16-3DT			0.213	3°
	AN16-2DT	0.213		2°	
	AN16-0DT	0.213		0°	
	AN16-99DT	0.213		-1°	
	AN16-98DT	0.213		-2°	
	AN16-4	0.157		4°	
	AN16-3	0.157		3°	
	AN16-2	0.157		2°	
	AN16-0	0.157		0°	
	AN16-99	0.157		-1°	
	AN16-98	0.157		-2°	
	GXE16-98	0.374		0.157	-2°
	GXE16-98DT			0.213	-2°
	GXE16-99			0.157	-1°
	GXE16-99DT			0.213	-1°
	GXE16-0		0.157	0°	
	GXE16-0DT		0.213	0°	
	GXE16-1		0.169	1°	
	GX16-1DT		0.213	1°	
	GXE16-2		0.157	2°	
	GXE16-2DT		0.213	2°	
	GXE16-3		0.157	3°	
	GXE16-3DT		0.213	3°	
	GXE16-4		0.157	4°	
	GXE16-4DT		0.213	4°	
	GXE22-98DT		0.500	0.260	-2°
	GXE22-99DT				-1°
	GXE22-0DT	0°			
	GX22-1DT	1°			
	GXE22-2DT	2°			
	GXE22-3DT	3°			
	GXE22-4DT	4°			
	GXN16-98	0.374			0.157
	GXN16-98DT		0.213	-2°	
	GXN16-99		0.157	-1°	
	GXN16-99DT		0.213	-1°	
	GXN16-0		0.157	0°	
	GXN16-0DT		0.213	0°	
	GXN16-1		0.169	1°	
	GXN16-2		0.157	2°	
	GXN16-2DT		0.213	2°	
	GXN16-3		0.157	3°	
	GXN16-3DT		0.213	3°	
	GXN16-4		0.157	4°	
	GXN16-4DT		0.213	4°	
	GXN22-98DT		0.500	0.260	-2°
	GXN22-99DT				-1°
	GXN22-0DT				0°
	GXN22-2DT	2°			
	GXN22-3DT	3°			
	GXN22-4DT	4°			



(D30)

User's Guide- Parts for Tools

Shims

Shape	Designation	Dimension (in)				
		a	øa	ℓ	c	Lead angle
	NXE22-98		0.500	0.157		-2°
	NXE22-99				-1°	
	NXE22-0				0°	
	NXE22-1				1°	
	NXE22-2				2°	
	NXE22-3				3°	
	NXE22-4		4°			
	NXE27-98		0.626	0.157		-2°
	NXE27-99				-1°	
	NXE27-0				0°	
	NXE27-1				1°	
	NXE27-2				2°	
	NXE27-3				3°	
	NXE27-4		4°			
	NXN22-98		0.500	0.157		-2°
	NXN22-99				-1°	
	NXN22-0				0°	
	NXN22-1				1°	
	NXN22-2				2°	
	NXN22-3				3°	
NXN22-4		4°				
NXN27-98		0.626	0.157		-2°	
NXN27-99				-1°		
NXN27-0				0°		
NXN27-1				1°		
NXN27-2				2°		
NXN27-3				3°		
NXN27-4		4°				
(D30)	TSL12R	0.472		0.185	0.177	4.5°
	TSL12L	0.472		0.185	0.177	4.5°
	TSL16R	0.626		0.252	0.197	5°
	TSL16L	0.626		0.252	0.197	5°
	TSL24R	0.937		0.370	0.279	7°
	TSL24L	0.937		0.370	0.279	7°
	TSL12RI	0.421		0.185	0.177	4.5°
	TSL12LI	0.421		0.185	0.177	4.5°
	TSL16RI	0.591		0.252	0.197	5°
(D30)	TSL16LI	0.591		0.252	0.197	5°

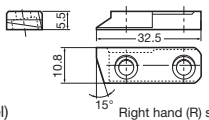
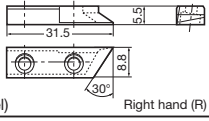
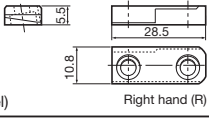
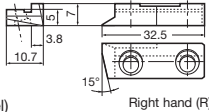
Shape	Designation
	SL-1R
	SL-1L
(Steel) Right hand (R) shown	
	SL-2R
	SL-2L
(Steel) Right hand (R) shown	
	SL-3R
	SL-3L
(Steel) Right hand (R) shown	
	SL-6R
	SL-6L
(Steel) Right hand (R) shown	

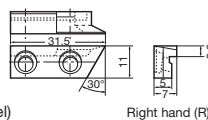
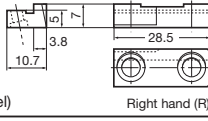
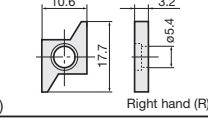
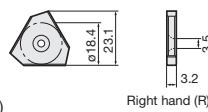
Shape	Designation
	SL-7R
	SL-7L
(Steel) Right hand (R) shown	
	SL-8R
	SL-8L
(Steel) Right hand (R) shown	
	SGSR151
	SGSL151
(D30) Right hand (R) shown	
	STN62R
	STN62L
(D30) Right hand (R) shown	

User's Guide- Parts for Tools

Clamps

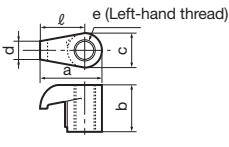
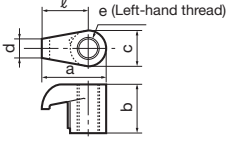
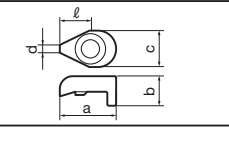
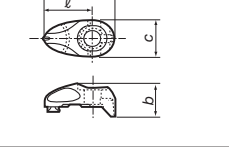
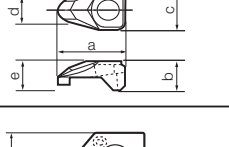
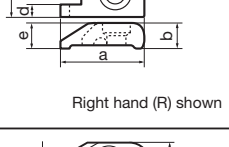
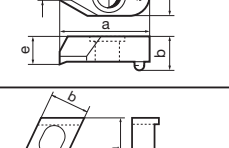
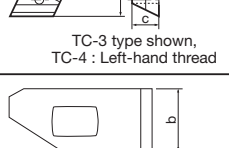
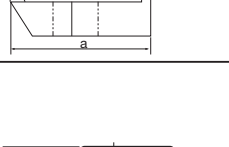
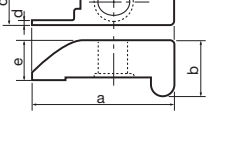
Shape	Designation	Dimension (in)					
		a	b	c	d	e	ℓ
 (Steel)	MCL-5M	0.579	0.433	0.307	0.157	M5	0.425
	MCL-6	0.732	0.453	0.374		M6	0.543
	MCL-8S	0.752	0.531	0.429	0.197	M8	0.535
	MCL-8M	0.886					0.669
	MCL-8L	1.000	0.571	0.157	0.787		
 (Steel)	MCPM-6	0.579	0.441	0.311	0.157	M5	0.425
	MCPM-9	0.752	0.661	0.429	0.197	M8×1	0.535
	MCPM-12	0.886					0.669
	MCPM-20	0.732	0.374	0.374	0.157	M6	0.543
	MCPM-21		0.480				0.657
	MCPM-22	0.846	0.520	0.787			
	MCPM-30	1.000	0.661	0.429	0.197	M8×1	0.787
 (Steel)	DCPM-33	0.630	0.366	0.413	0.094		0.335
	DCPM-43	0.835	0.453	0.531	0.118		0.520
	DCPM-54	1.020	0.600	0.551	0.138		
	DCPM-64	1.104	0.610	0.630	0.157		
 (Steel)	ACP3S	0.898	0.375	0.394			0.591
	ACP3S-E	0.854	0.375	0.394			0.547
	ACP3L-E	1.038	0.472	0.512			0.723
	ACP4S	1.012	0.472	0.512			0.697
	ACP5S	1.185	0.508	0.591			0.815
	ACP6S	1.315	0.508	0.650			0.945
 (Steel)	ACP3	0.705	0.315	0.394	0.256	0.248	
	ACP4	1.000	0.439	0.472	0.276	0.315	
 (Steel)	CTC-3R	1.142	0.346	0.630	0.087	0.315	
	CTC-3L						
	CTC-4R			0.669	0.126		
	CTC-4L						
	CTC-5R			0.709	0.165		
CTC-5L							
 (Steel)	CP81A	1.102	0.413	0.472	0.138	0.315	
	CP81B						
 (Steel)	TC-3	0.748	0.492	0.327	-	-	-
	TC-4	0.850		0.315			
 (Steel)	TF-72	0.866	0.455				
	TF-73	0.866	0.455				
	TF-184	0.866	0.455				
	TF-185	0.866	0.455				
 (Steel)	CCR2	1.366	0.587	0.421	0.047	0.413	
	CCL2						
	CCR3				0.087		
	CCL3						
	CCR4				0.110		
	CCL4						
	CCR5				0.126		
	CCL5						
	CCR6				0.154		
	CCL6						
CCR8	0.193						
CCL8							

User's Guide- Parts for Tools

Clamps

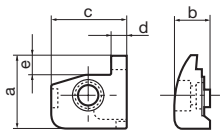
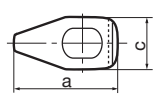
Shape	Designation	Dimension (in)							
		a	b	c	d	e			
 <p>Right hand (R) shown</p>	CFG-3SR	0.866	0.433	0.909	0.079	0.236			
	CFG-3SL								
	CFG-4SR								
	CFG-4SL								
	CFG-4DR	1.260							
	CFG-4DL								
	CFG-5SR	0.866			0.157		0.236		
	CFG-5SL								
	CFG-5DR	1.260							
	CFG-5DL					0.630			
	CFG-6SR	0.906			0.197		0.276		
	CFG-6SL								
	CFG-6DR	1.299							
	CFG-6DL					0.669			
	CFG-8SR	1.102			1.067	0.276		0.315	
	CFG-8SL								
CFG-8DR	1.496								
CFG-8DL			0.709						
(Steel)									
	CCP4-A	1.146		0.551					
	(Steel)								

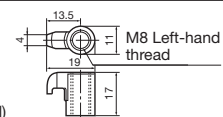
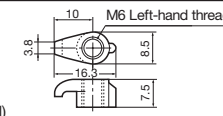
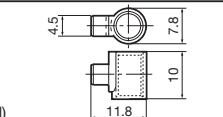
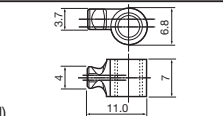
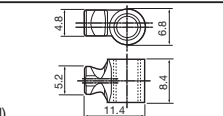
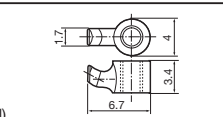
Shape	Designation
 <p>M8 Left-hand thread</p>	NF-84A
(Steel)	
 <p>M6 Left-hand thread</p>	CP536
(Steel)	
	CP91
(Steel)	
	CP900
(Steel)	
	CP910
(Steel)	
	JCP-1
(Steel)	

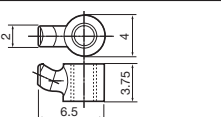
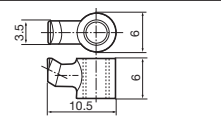
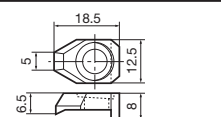
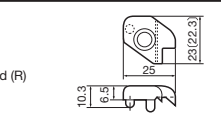
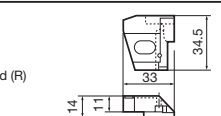
Shape	Designation
	JCP-2
(Steel)	
	JCP-3 JCP-3N
(Steel)	
	CQ-1
(Steel)	
 <p>Right hand (R) shown (Steel)</p>	CPK5R CPK5L
 <p>Right hand (R) shown (Steel)</p>	C11R-5 C11L-5

User's Guide- Parts for Tools

Clamp Sets

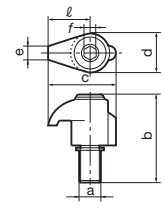
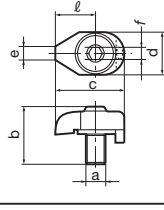
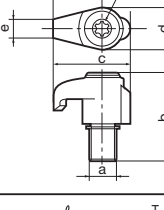
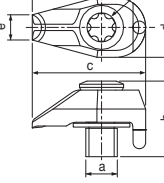
Shape	Designation	Dimension (in)						
		a	b	c	d	e	ℓ	T / f
 (Steel)	CSG-5S	M5×0.8	0.531	0.543	0.276	0.071	0.335	0.098
	CSG-5		0.610					
	CSG-6S	M6×1	0.709	0.642	0.335	0.098	0.394	0.118
	CSG-6L		0.846					
	CSG-8S	M8×1	0.827	0.807	0.433	0.138	0.492	0.157
	CSG-8		0.925					
	 (Steel)	CSW-00	M4×0.7	0.453	0.472	0.315	0.079	0.295
CSW-1		M5×0.8	0.650	0.650	0.374	0.157	0.394	
CSW-0		M4×0.7	0.453	0.543	0.335	0.098	0.315	0.157
CSW-2		M6×1	0.787	0.807	0.433	0.236	0.512	
CSW-40		M4×0.7	0.472	0.520	0.315	0.079	0.295	0.098
CSW-50		M5×0.8	0.591	0.665	0.394		0.374	0.118
 (Steel)		CSP16	M5×0.8	0.610	0.567	0.272	0.126	0.358
	CSP22	M6×1	0.787	0.713	0.350	0.165	0.453	T20
	CSP27	M8×1.25	0.925	0.961	0.469	0.154	0.614	0.157
 (Steel)	CSY-15	M4×0.7	0.457	0.453	0.276	0.118	0.236	15IP
	CSY-20	M5×0.8	0.472	0.709	0.374	0.157	0.433	20IP

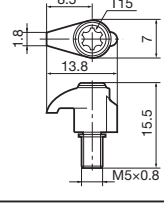
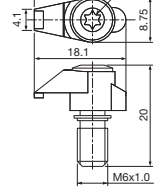
Shape	Designation
 (Steel)	CSG-5T
 (Steel)	CSX20

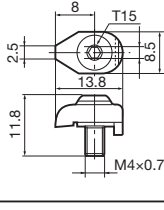
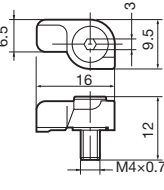
Shape	Designation
 (Steel)	CSW-0T
 (Steel)	CSL-4

User's Guide- Parts for Tools

Levers

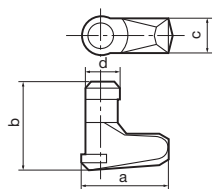
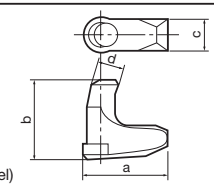
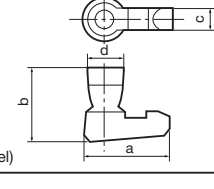
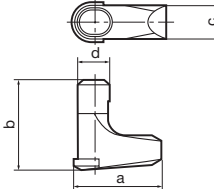
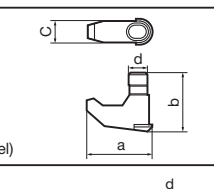
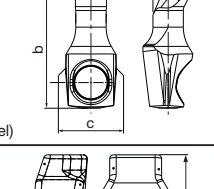
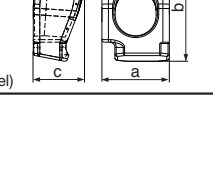
Shape	Designation	Dimension (in)			
		a	b	c	d
 (Steel)	LCL3	0.394	0.472	0.146	0.142
	LCL4	0.575	0.551	0.185	0.185
	LCL5	0.673	0.669	0.236	0.236
	LCL6	0.807	0.827	0.295	0.295
	LCL8	1.000	1.000	0.339	0.339
 (Steel)	LCL3C	0.425	0.465	0.134	0.118
	LCL4C	0.512	0.528	0.146	0.134
	LCL5C	0.732	0.697	0.185	0.177
	LCL6C	0.807	0.748	0.236	0.224
	LCL8C	0.953	0.925	0.295	0.244
 (Steel)	LCL22N	0.295	0.256	0.102	0.081
	LCL32N	0.394	0.307	0.126	0.126
	LCL33NL	0.453	0.374	0.122	0.142
	LCL33N	0.394	0.370	0.126	0.126
	LCL43N	0.528	0.394	0.185	0.185
 (Steel)	LCL23				
	LCL33	0.307	0.335	0.102	0.083
	LCL33L	0.398	0.476	0.142	0.146
	LCL43S				
	LCL43M	0.531	0.520	0.185	0.185
	LCL44	0.531	0.520	0.185	0.185
LCL54	0.634	0.575	0.185	0.185	
 (Steel)	DLCL43	0.612	0.551	0.197	0.185
	DLCL54	0.752	0.752	0.240	0.236
	DLCL64	0.846	0.827	0.295	0.295
 (Steel)	SLLV-1		0.305	0.134	0.096
	SLLV-2		0.305	0.134	0.108
 (Steel)	FCL4	0.197	0.306	0.150	
	FCL8	0.394	0.563	0.212	

User's Guide- Parts for Tools

Pins

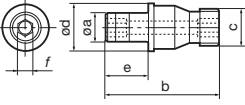
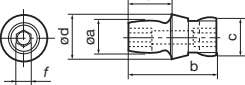
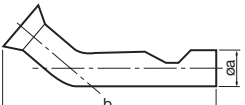

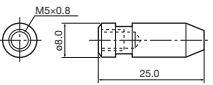
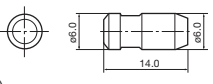
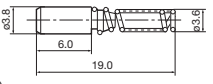
Shape	Designation	Dimension (in)					
		øa	b	øc	ød	e	f
 (Steel)	MLP32L	0.154	0.346	M5×0.8	0.220	0.138	0.079
	MLP33	0.146					
	MLP34L	0.146	0.516	M6.3×1	0.307	0.217	0.098
	MLP46	0.197	0.677				
	MLP46L		0.732				
	MLP58	0.244	0.862	M8×1	0.406	0.272	0.118
	MLP68	0.307					
	MLP68L		0.949				
 (Steel)	MLP44	0.197	0.520	M6.3×1	0.280	0.217	0.098
	MLP33L	0.146	0.409	M5×0.8	0.220	0.201	0.079
 (Steel)	SW99	0.315	1.870				

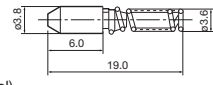
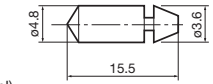
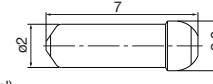
Shape	Designation
 (Steel)	SP-8
 (Steel)	SP-6
 (Steel)	BP-3

Shape	Designation
 (Steel)	BP-360
 (Steel)	BP-490
 (Steel)	SL-PI-2

User's Guide- Parts for Tools

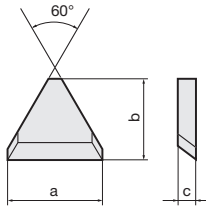
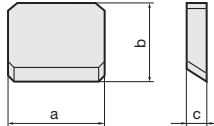
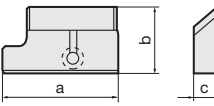
Chipbreaker Pieces

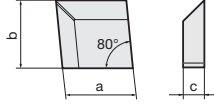
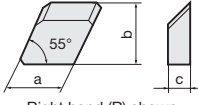
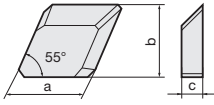
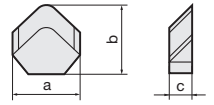
Shape	Designation	Dimension (in)			
		a	b	c	
 (TX30)	CBT-2S	0.346	0.299	0.079	
	CBT-2M	0.291	0.260		
	CBT-3S	0.524	0.476	0.098	
	CBT-3M	0.484	0.437		
	CBT-3L	0.445	0.398		
	CBT-4S	0.740	0.665		
	CBT-4M	0.701	0.626		
	CBT-4L	0.661	0.567		
	NCT-2S	0.559	0.465		
	NCT-2M	0.512	0.425		
	NCT-2L	0.469	0.386		
	 (TX30)	CBS-3S	0.374		0.327
CBS-3M		0.287			
CBS-4S		0.500	0.457	0.098	
CBS-4SN					
CBS-4M			0.417		
CBS-4L			0.358		
NCS-3S			0.441		
NCS-3M			0.402		
NCS-3L			0.343		
 Right hand (R) shown (TX30)	B11 R-5	0.945	0.512	0.197	
	B11 L-5				
 (TX30)	CBS-4SN	0.453	0.453	0.098	
	CBS-4MN	0.413	0.413		
	CBS-4LN	0.354	0.354		
	NCS-3SN	0.441	0.441		
	NCS-3MN	0.402	0.402		
	NCS-3LN	0.343	0.343		
 (TX30)	CBC-4SN	0.453	0.453	0.098	
	CBC-4MN	0.413	0.413		
	CBC-4LN	0.374	0.374		
 Right hand (R) shown (TX30)	CBD-4SR	0.500	0.453	0.098	
	CBD-4MR		0.413		
	CBD-4ML				
	CBD-4LR		0.374		
 (TX30)	CBD-4SN	0.453	0.453	0.098	
	CBD-4MN	0.413	0.413		
 (TX30)	CBR-4SN	0.500	0.469	0.098	
	CBR-4MN		0.429		

User's Guide- Parts for Tools

Springs (Springs for Shims)

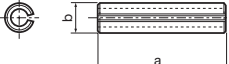
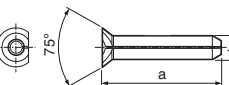
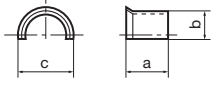
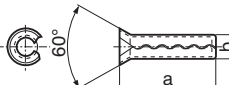
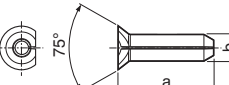
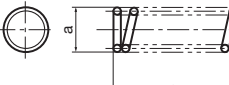
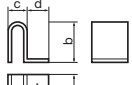
Shape	Designation	Dimension (in)					
		a	b	c	d		
 (Steel)	SP-2.5	0.472	0.106				
 (Steel)	SP-16-L14	0.535	0.112				
 (Steel)	LSP3	0.217	0.118	0.232			
	LSP3L	0.276					
	LSP4		0.157	0.299			
	LSP4S	0.236					
	LSP5	0.335	0.177	0.346			
	LSP6	0.433	0.232	0.429			
	LSP6C	0.335	0.189	0.366			
	LSP8	0.472	0.394	0.606			
 (Steel)	PSP-2.5	0.394	0.106				
	PSP-4.0	0.630	0.165				
	PSP301	0.299	0.118				
 (Steel)	PSP-16	0.384	0.112				
 (Steel)	BP-0	0.142	0.512				
	BP-5-A						
	BP-7	0.276	0.433				
	BP-8.8	0.347	0.394				
	BP-9	0.327	0.394				
	BP-10	0.358					
	SP913	0.354	0.512				
 (Steel)	BSP-1	0.307	0.295	0.189	0.236		

User's Guide- Parts for Tools

Coolant Supply Attachment

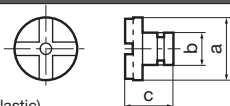
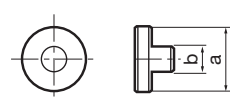
Shape	Designation	Dimension (in)				
		a	b	c	Thread	
 (Plastic)	EA-20	0.787	0.394	0.591		
	EA-25	0.984				
	EA-32	1.260	0.630			
 (Plastic)	CA-16	0.630	0.315		M6	
	CA-20	0.787	0.335		M6	
	CA-25	0.984	0.453		R1/8	
	CA-32	1.260	0.453		R1/8	
	CA-40	1.575	0.453		R1/8	

Pistons

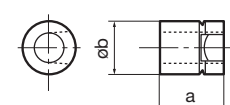
Shape	Designation	Dimension (in)			
		a	øb		
 (Steel)	DPIS33	0.496	0.354		
	DPIS43	0.465	0.394		
	DPIS44	0.528	0.394		
	DPIS54	0.630	0.512		
	DPIS64		0.591		

Nuts

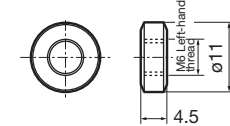
Shape	Designation
	SRW11

Coolant Pipe & Nozzle

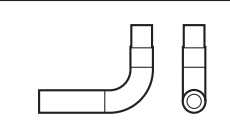
Shape	Designation
	PNZ5

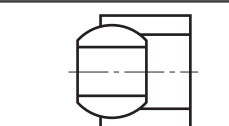
Shape	Designation
	CNZ125

Coolant unit

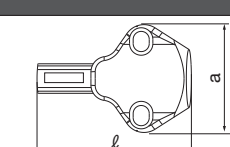
Shape	Designation	Dimension (in)	
		a	l
	CU-CW-CHP	0.819	1.169
	CU-D-CHP	0.819	1.165
	CU-V-CHP	0.819	1.181

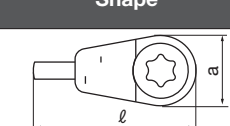
Shape	Designation	Dimension (in)	
		a	l
	S-CU-CHP	0.276	0.638

O-ring for TungTurn-Jet

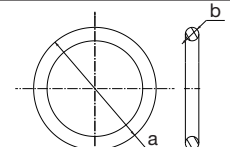
Shape	Designation	Dimension (in)			
		a	øb		
 (Rubber)	OR6.4X0.9N	0.323	0.035		
	OR14X2.5NN	0.748	0.098		

User's Guide- Parts for Tools

Coolant screw for TungTurn-Jet

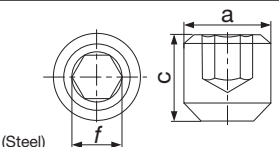
Shape	Designation	Dimension (in)			
		a	c		T / f
 (Steel)	SRM4X4 TL360	M4	0.157		0.079

Mounting screw for TungTurn-Jet

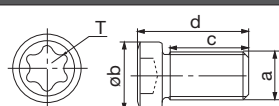
Shape	Designation	Dimension (in)				
		a	øb	c	d	T / f
 (Steel)	SRM3	M3X0.5	0.165	0.276	0.193	T8

Sizing Plates

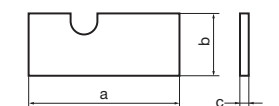
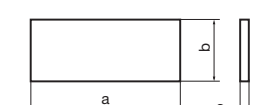
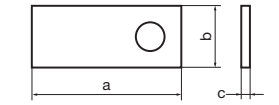
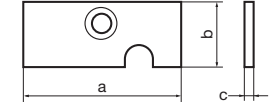
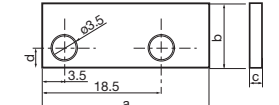
Shape	Designation	Dimension (in)					
		a	b	c	d		
 (Steel)	S0816A	2.165	0.610	0.031			
	S1016A			0.039			
	S0816B	1.969		0.031			
	S1016B			0.039			
	S0816C	1.772		0.031			
	S1016C			0.039			
	S0820A	2.402		0.768	0.031		
	S1020A				0.039		
	S0820B	2.146			0.031		
	S1020B				0.039		
SM-00	0.709	0.315	0.039				
 (Steel)	SW04	1.000	0.228		0.010		
	SW05	1.457	0.327		0.010		
		1.417	0.425		0.020		
	SW06	1.417	0.425		0.039		
					0.079		
SW08	1.575	0.433	0.031				
 (Steel)	S0810	1.575	0.433	0.039			
	S1010	1.575	0.433	0.039			
 Attached with fix screw and wrench. (Steel)	PSTR08	0.945	0.433	0.059			
	PSTL08						
	PSTR10	1.654		0.650	0.079		
	PSTL10						
	PSTR12	1.850			0.748	0.079	
PSTL12							
 (Steel)	AP0801	1.024	0.377			0.020	0.118
	AP0802			0.039			
	AP0803			0.059			
	AP0804			0.079			
	AP0805			0.098			
	AP1101	1.181		0.453	0.020	0.197	
	AP1102				0.039		
	AP1103				0.059		
	AP1104				0.079		
	AP1105				0.098		
AP1106		0.118					

SW04 is composed of three plates and SW05 to SW08 are composed of four plates.

Note on fixing screws: PSTR/L08 is attached with CSSM2-4 and other types are attached with CSHM3-8.

User's Guide- Parts for Tools

Washers

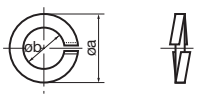
Shape	Designation	Dimension (in)					
		ϕa	ϕb				
	VA4	0.299	0.161				
	VA5	0.362	0.201				
	VA6	0.413	0.240				

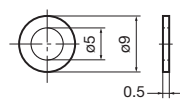
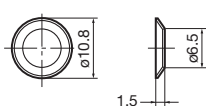

Shape	Designation
	CPW5
	CDW6

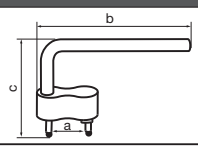
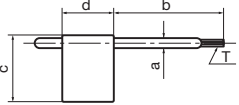
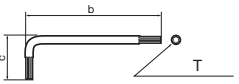
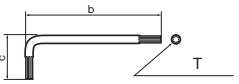
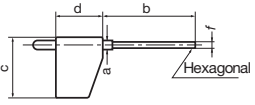
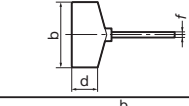
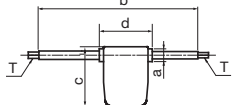
Wrenches and Drivers

Shape	Designation	Dimension (in)					
		a	b	c	d	f	T
	CRW23	0.382	3.091	2.165			
	CRW33	0.366	3.091	2.165			
	T-6F	0.067	1.358	0.591	0.591		T6
	T-7F	0.079	1.358	0.748	0.748		T7
	T-8F	0.091	1.535	0.748	0.748		T8
	T-9F	0.098	1.673	0.748	0.748		T9
	T-15F	0.130	1.772	1.063	0.866		T15
	T-20F	0.154	1.929	1.181	0.866		T20
	IP-6F	0.067	1.358	0.591	0.591		6IP
	SET T-15/5	0.138	1.772	1.102	0.827		T15
	T-20TORX	0.154	1.929	1.181	0.866		T20
	T-6L		1.890	0.630			T6
	T-8L		1.890	0.630			T8
	T-9L		1.890	0.630			T9
	T-15L		2.232	0.866			T15
	T-25TORX		2.598	0.917			T25
	KEYV-T20		2.362	0.866			T20
	KEYV-T25		2.559	0.906			T25
	KEYV-T30L		7.480	1.457			T30
	KEYV-T40L		8.189	1.693			T40
	KEYV-T50L		9.134	1.890			T50
	P-2F	0.157	1.555	0.787	0.492	0.079	
	P-2.5F	0.197	1.772	0.984	0.787	0.098	
	HW2.0/5RED	0.118	1.496	0.591	0.591	0.079	
	P-2.5T		1.654		0.591	0.098	
	T-1008/5	0.256	3.347	1.102	0.984	-	T10/T8
	T-2010/5	0.256	3.347	1.102	0.984	-	T10/T20

User's Guide- Parts for Tools

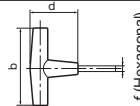
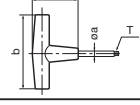
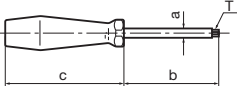
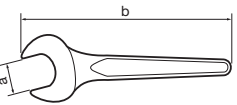
Wrenches, Drivers and Lubricant

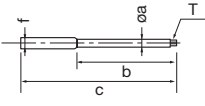
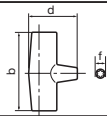
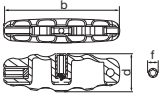
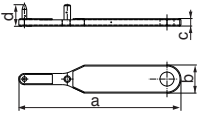
Shape	Designation	Dimension (in)					
		a	b	c	d	f	T
	1/4HEX					0.250	
	5/32HEX					0.156	
	1/8HEX					0.125	
	3/32HEX					0.094	
	P-2					0.079	
	P-2.5					0.098	
	P-3					0.118	
	P-3.5					0.138	
	P-4					0.157	
	P-4.5					0.177	
	P-5					0.197	
	P-6					0.236	
	TP-3A		2.756		1.791	0.118	
	TP-4		3.346		2.087	0.157	
	TP-5					0.197	
	T-15T						T15
	T-20T	0.197	2.559		1.772		T20
	T-27T		3.346		1.654		T27
	IP-20T	0.197	3.150		1.772		20IP
 <p>Handle shape somewhat varies depending on the type number from the above figure.</p>	T-6D	0.098		2.756			T6
	T-7D	0.079	1.772				T7
	T-8D	0.091	2.165				T8
	T-9D	0.098	2.559	3.150			T9
	T-10D			3.543			T10
	T-15D	0.130	2.756				T15
	T-20D	0.154	3.543	3.937			T20
	T-25D	0.173	3.425	3.386			T25
	IP-6DB		1.772	2.756			6IP
	IP-7D	0.102	1.772	2.756			7IP
	IP-8D	0.110	2.205	2.717			8IP
	IP-10D	0.130	2.795	3.504			10IP
	IP-15D	0.154	2.756	3.937			15IP
	IP-20D	0.181	3.543	3.937			20IP
	KS-21	0.827	7.677				
	KS-24	0.945	8.465				
	KS-27	1.063	9.252				
	KS-32	1.260	10.827				
	KS-36	1.417	12.008				
	M-1000						
	BT15S	0.154	1.969	3.543		0.236	T15
	BT15M	0.154	1.969	4.646		0.236	T15
	BT20S	0.181	1.969	3.543		0.236	T20
	BT20M	0.181	1.969	4.646		0.236	T20
	BLD IP15/S7	0.154	1.969	3.543		0.236	15IP
	BLD IP15/M7	0.181	1.969	3.543		0.236	15IP
	BLD IP20/S7	0.181	1.969	4.646		0.236	20IP
	BLD IP20/M7	0.181	1.969	4.646		0.236	20IP
	BLD T10/S7						
	H-TB		3.937		1.457	0.236	
	H-TBS		2.953		1.457	0.236	
	H-TB2W		3.740		1.236	0.236	
	ECW-456EF	3.425	0.591	0.157	0.453		
	ECW-456I	3.169	0.866	0.157	0.413		

User's Guide- Parts for Tools

Wrenches and Drivers

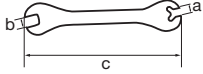
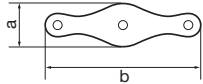
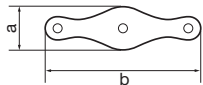
Shape	Designation	Dimension (in)					
		a	b	c	d	f	T
	KEYV-S05	0.157	0.217	3.937			
	KEYV-S06	0.213	0.315	4.921			
	KEYV-S08	0.260	0.394	5.906			
	KEYV-S10	0.303	0.512	6.890			
	KEYV-S12	0.370	0.630	9.843			
	KEYV-W20						
	KEYV-177	1.142	4.331				
	KEYV-217	1.142	4.331				
	KGDT-100	1.260	4.272				
	KGDT-110	1.260	4.272				
	KGDT-120	1.260	4.272				
	KGDT-130	1.260	4.272				
	KGDT-140	1.260	4.272				
	KGDT-150	1.260	4.272				

User's Guide- Parts for Tools

Locators

Designation	Applicable Tool
LD150R	TXD15125R ~ TXD15315R
LD440R/L	TMD44 TGD4400R/L-A TFD44
LD442R/L	EGD4400R
LD540R/L	TMD54
LE302R	ESE3050R (RS**) ~ 3063R (RS**)
LE303R/L	TSE3003R/LIA ~ 3006R/LIA
LE402AR	ESE4050RA ESE4063RA
LE403R/L	TSE4003R/LIA TSE4004R/LIA ESE4003RIA-S32
LE405R/L	TSE4005R/LIA ~ 4012R/LIA
LE413R/L	THE40
LE444R/L	TME4403R/LI ~ 4405R/LI TME4403R/LB ~ 4405R/LB EME4405R ~ 4404RI
LE446R/L	TME4406R/LI ~ 4412R/LI TME4406R/LB ~ 4412R/LB
LE540R/L	TME54
LF440R/L	THF44
LF540R/L	THF54
LF602R	ERF6050R ~ ERF6063R
LF602R/L	TRF6003R/LI ~ TRF6006R/LI TRF6008R/LI ~ TRF6012R/LI
LMS56R/L	MS08R/L ~ MS12R/L
LN423R/L	TGN42
LN645R/L	TPN64
LP403R/L	TSP4003R/LIA ~ TSP4004R/LIA TFP4004R/LIA
LP405R/L	TSP4005R/LIA ~ TSP4012R/LIA TFP4005R/LIA ~ TFP4012R/LIA
LP413R/L	TGP41 TGP42
LP514R/L	TGP51
LPP16R	TPP16
LR602R/L	ERD6050RA ~ ERD6063RA
LR603R/L	TRD6003R/L TRD6004R/L ~ TRD6008R/L
LV525R/L	VSN 1
LV530R/L	VSN 2
LV556R/L	VSN60
LW400R	EFP4063R
LW400R/L	TFD44 TFP4000 SFP4000
LW402R	EFP4050R

User's Guide- Parts for Tools

Insert locking wedges

Designation	Applicable Tool
FDS-8SST	EDPD09063R EDPD09063RB
FDS-8ST-18	EDP09080R EDPD09080RB DPD09100R~DPD09160R DPD09100RB~DPD09160RB
FW-242R/L	ø63
FW-243R/L	ø80~100
FW-245R/L	ø125 ~
FW304R/L-D	DAD15 DPD15 EDPD15 QPP15
LE302R	ESE3050R (RS**) ~ 3063R (RS**)
WF150R	TXD15125R ~ TXD15315R
WF310R/L	TGP4100BA TGP4103R/LIA
WF330N	TSE4003R/LIA TSE4004R/LIA ESE4003RIA-S32 TSP4003R/LIA ~ TSP4004R/LIA TFP4004R/LIA
WF330R/L	TSE3003R/LIA ~ 3006R/LIA
WF444R/L	TME4403R/LI ~ 4405R/LI TME4403R/LB ~ 4405R/LB EME4405R ~ 4404RI TME4406R/LI ~ 4412R/LI TME4406R/LB ~ 4412R/LB
WF500R	TSE4005R/LIA ~ 4012R/LIA TSP4005R/LIA ~ TSP4012R/LIA TFP4005R/LIA ~ TFP4012R/LIA
WF500R/L	TMD54 TGP51 THF54
WF50R/L	TME54
WF602R	ERF6050R ~ ERF6063R
WF603R/L	TRF6003R/LI ~ TRF600R/LI
WF608R/L	TRF6008R/LI ~ TRF6012R/LI
WN645R/L	TPN64
WP193TR/L	EGD4400R
WP440R/L	TMD44 TGD4400R/L-A TFD44 TGP4100IA ~ TGP4112R/LIA TGP42 THF44 THE40
WR602R/LW	ERD6050RA ~ ERD6063RA
WR603R/L	TRD6003R/L TRD6004R/L ~ TRD6008R/L
WT402R	ESE4050RA ESE4063RA
WT402R/L	EME4450RB ~ 4404RB

User's Guide- Parts for Tools

Locator adjusting wedges

Designation	Applicable Tool
FW-305	TFD44 TFP40 SFP4000 EFP4063
FW325R/L-D	DAD15 QPP15 DPD15 EDPD15

Fine adjusting screws

Designation	Applicable Tool
AJM5	DPD09 EDPD09
ASM34L	DPD24

Turning Tools

Name of tools parts

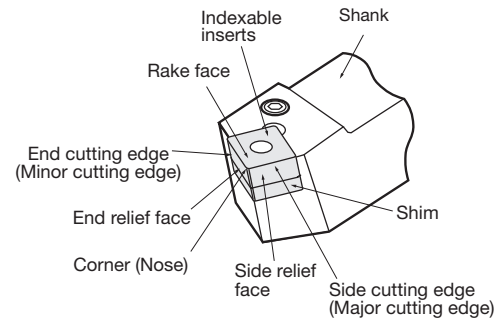
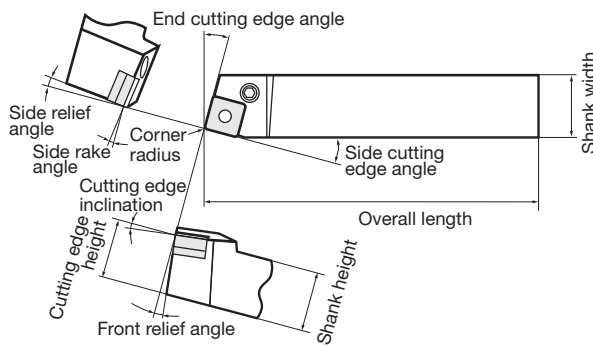

Relating angles between tool and workpiece

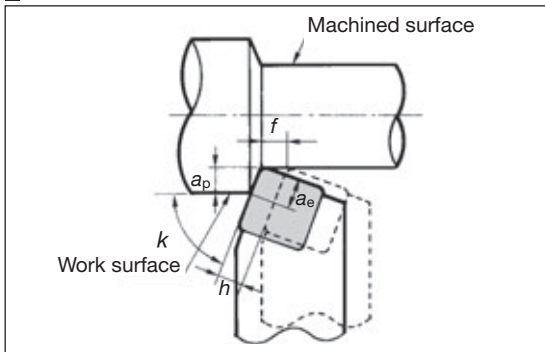

- a_p ... Depth of cut (Distance between work surface and machined surface)
- a_e ... Length of cutting edge engaging in cutting.
- κ ... Cutting edge angle (Angle to be made by cutting edge and work surface)
- f ... Feed per revolution
- h ... Thickness to be cut per revolution
- Machined surface ... Workpiece surface after machined.
- Work surface ... Workpiece surface to be cut.

Effect of side cutting edge angle

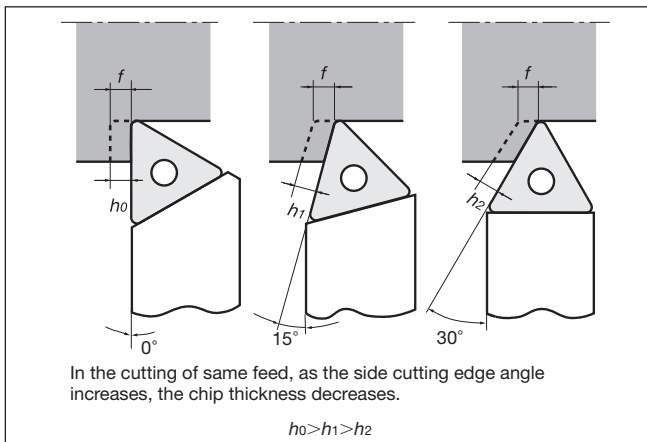

Honing

TAC indexable inserts of steel cutting grades are honed. Honing specifications are shown in the following table.

Edge condition	Shape
Sharp edge	
Round honing	
Chamfered honing	

Effects of tool geometry on cutting phenomena

Phenomena	Flank wear	Crater wear	Edge strength	Cutting force	Surface finish	Chattering	Cutting edge temperature	Chip shape and flow
Increasing Cutting edge inclination	-	Decrease	Lower	Radial force decrease	-	Less tendency	Lower	Effect on flow direction
Side rake angle	-	Decrease	Lower	Decrease	-	-	Lower	Effect on shape
Relief angle	Decrease	-	Lower	Decrease	-	Likely to occur	Lower	-
End cutting edge angle	Decrease	-	Lower	Radial force decrease	Roughen	Less tendency	Lower	-
Side cutting edge angle	Decrease	Decrease	Increase	Radial force decrease	-	Likely to occur	Increase	Decrease thickness
Nose radius	Decrease to some level		Increase	Increase	Improve	Likely to occur	Increase	Effect on flow direction
Honing width	Increase	-	Increase	Increase	-	Likely to occur	Increase	-

User's Guide- Technical Reference

Turning Tools

Relations between cutting force and cutting conditions or cutting phenomena

Condition	Grey cast iron (HB130)	Stainless steel (HB145)	Carbon steel (HB230)
Cutting speed and cutting force $f = 0.008$ ipr $a_p = 0.079$ " Side cutting edge angle 0° Corner radius $r_\epsilon = 0.016$ "			
Depth of cut and cutting force $V_c = 330$ SFM $f = 0.008$ ipr Side cutting edge angle 0° Corner radius $r_\epsilon = 0.016$ "			
Feed and cutting force $V_c = 330$ SFM $a_p = 0.079$ " Side cutting edge angle 0° Corner radius $r_\epsilon = 0.016$ "			
Corner radius and cutting force $V_c = 330$ SFM $f = 0.008$ ipr $a_p = 0.047$ " Side cutting edge angle 0°			
Side cutting edge angle and cutting force $V_c = 330$ SFM $f = 0.008$ ipr $a_p = 0.079$ " Corner radius $r_\epsilon = 0.016$ "			
Side rake angle and cutting force $V_c = 330$ SFM $f = 0.008$ ipr $a_p = 0.079$ " Side cutting edge angle 0° Corner radius $r_\epsilon = 0.008$ "			

Turning Tools

Calculation formulas for turning

●Cutting speed

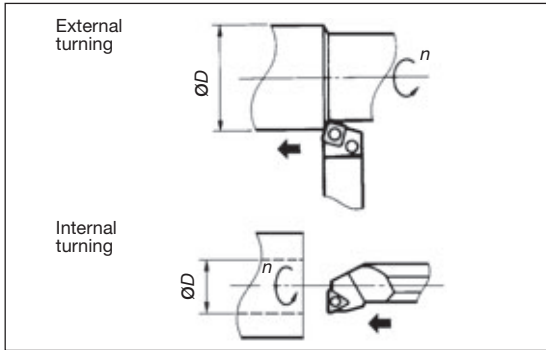

When calculating cutting speed from number of revolutions:

$$SFM = \frac{RPM \times \phi D}{3.82}$$

SFM: Surface feet per minute
RPM: Revolutions per minute
 ϕD : Diameter

When calculating required number of revolutions from cutting speed:

$$RPM = \frac{SFM \times 3.82}{\phi D}$$

SFM: Surface feet per minute
RPM: Revolutions per minute
 ϕD : Diameter

●Cutting time on external and internal turning

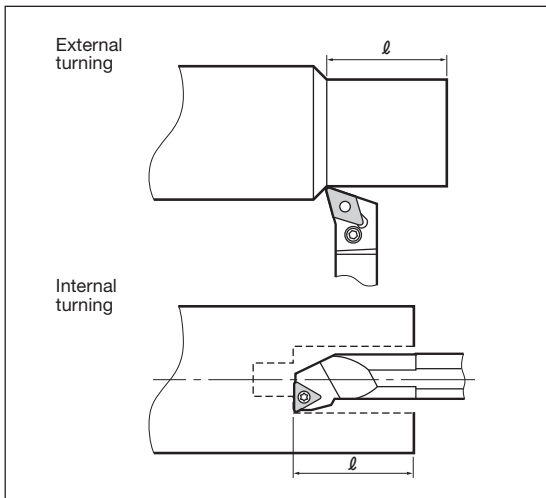

$$T = \frac{l}{f \times n}$$

(min)

T : Cutting time (min)
 l : Cutting length (in)
 f : Feed (ipr)
 n : RPM

●Cutting time on face turning

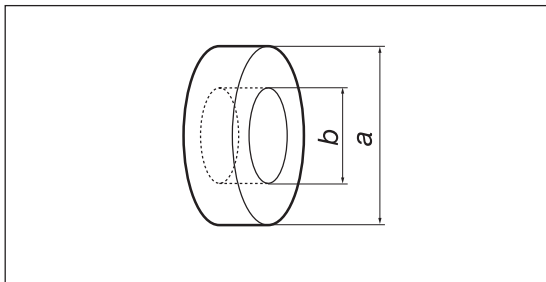

$$T = \frac{\pi \times (a^2 - b^2)}{48 \times V_c \times f}$$

(min)

V_c : Cutting speed (SFM)
 f : Feed (ipr)
T : Cutting Time (min)

●Theoretical surface roughness

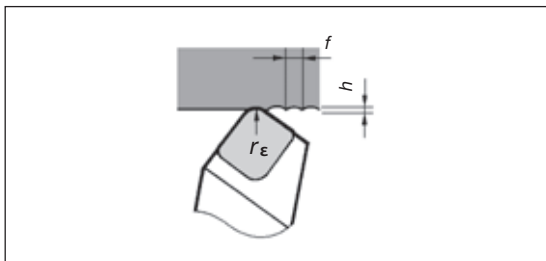

$$h = \frac{f^2}{8 r_\epsilon} \times 1000$$

(μm)

h : Surface roughness (μm)
 f : Feed (ipr)
 r_ϵ : Nose radius (in)

●Calculation of power consumption (kW)

$$P_c = \frac{F \times V_c}{33000}$$

(HP)

P_c : Power requirement (kW)
 F : Cutting force (N)
 V_c : Cutting speed (SFM)

User's Guide- Technical Reference

Turning Tools

●Cutting forces

- (1) Finding from the diagram based on experimental data.
- (2) In case determining by simplified equation:

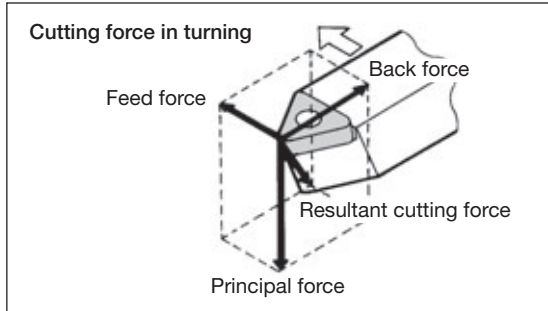

$$F = k_c \times a_p \times f \times 1000 \text{ (lb-force)}$$

F : Cutting force (lb-force)
 k_c : Specific cutting force
 KPI (Kilo pound force)
 [Refer to the Table below]
 a_p : Depth of cut (in)
 f : Feed (ipr)

Example :
 Calculating the cutting force when cutting a high carbon steel (1055) at $f = 0.007$ ipr and $a_p = 0.118$ ".
 $F = 499 \times 0.118 \times 0.0078 \times 1000 = 460$ lb-force

●Calculating power requirement

$$P_c = \frac{k_c \times a_p \times v_c \times f r}{33} \text{ (HP)}$$

P_c : Net power requirement (H)
 k_c : Specific cutting force (KPI)
 [Refer to the Table below]
 v_c : Cutting speed (SFM)
 a_p : Depth of cutting (in)
 f : Feed (ipr)

Value of specific cutting force (k_c)

Workpiece material (JIS)	Tensile strength lb/in ² (PSI)	Hardness (HB)	Value of specific cutting force on feed k_c (KPI)				
			0.0016 (ipr)	0.004 (ipr)	0.008 (ipr)	0.016 (ipr)	0.039 (ipr)
SS400, S15C	56,565	100	497	412	355	302	247
S35C, S40C	85,572	170	612	506	426	363	302
S50C, SCr430	113,855	230	711	583	497	426	348
SCM440, SNCM439	142,137	300	782	640	548	470	384
SDK	255,992 (56HRC)	56HRC	1,217	996	853	725	598
FC200	(160HB)	160	370	284	236	194	149
FCD600	(200HB)	200	483	370	306	254	194
Aluminum alloy	(89HB)	89	196	164	138	117	97
Aluminum			152	126	107	93	75
Magnesium alloy			57	57	57	57	57
Brass			157	157	157	157	157

●Bending stress and tool deflection

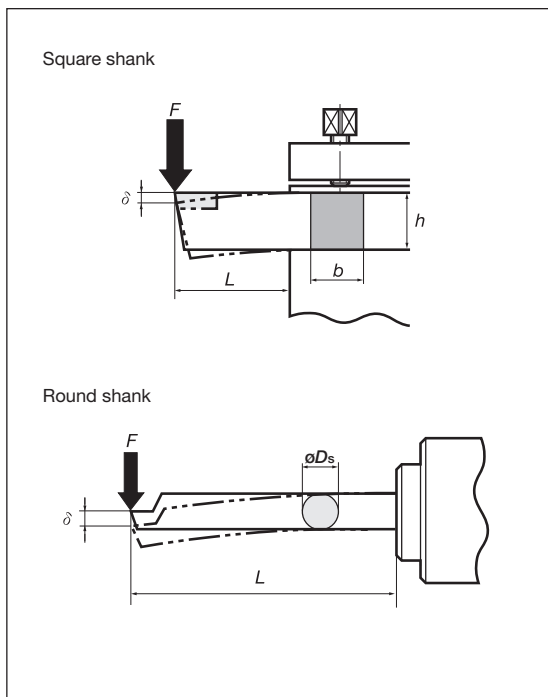

Bending stress

(1) Square shank

$$S = \frac{6 \times F \times L \times 145}{b \times h^2} \text{ (PSI)}$$

S : Bending stress in shank (PSI)
 F : Cutting force (lb)
 L : Overhang length of tool (in)
 b : Shank width (in)
 h : Shank height (in)

(2) Round shank

$$S = \frac{32 \times F \times L \times 145}{\pi \times \phi D_s^3} \text{ (PSI)}$$

ϕD_s : Shank diameter (in)
 E : Modulus of elasticity of shank material (lb/in²)

Tool deflection (in)

(1) Square shank

$$\delta = \frac{4 \times F \times L^3}{E \times b \times h^3} \text{ (in)}$$

(2) Round shank

$$\delta = \frac{64 \times F \times L^3}{3 \times \pi \times E \times \phi D_s^4} \text{ (in)}$$













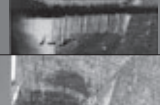



(Ref.) Values of E

Material	lb/in ² (SPI)	{kgf/mm ² }
Steel	30,457,980	30,457,980
Cemented Carbide	81,221,280 ~89,923,560	81,221,280 ~89,923,560

User's Guide- Technical Reference

Turning Tools

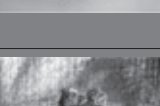
Troubleshooting in turning

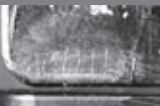
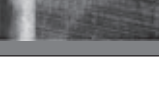
Typical tool failure		Countermeasure		
		Tool grade	Cutting conditions	Tool geometry
Flank wear		<ul style="list-style-type: none"> Change to more wear resistant grades P, M, K30 → 20 → 10 	<ul style="list-style-type: none"> Reduce cutting speed Change to appropriate feed Change to wet cutting 	<ul style="list-style-type: none"> Decrease honing width Increase relief angle Increase end cutting edge angle Increase corner radius Select free-cutting chipbreaker Increase rake angle
				
Crater wear		<ul style="list-style-type: none"> Change to more wear resistant grades P, M, K30 → 20 → 10 	<ul style="list-style-type: none"> Reduce cutting speed Reduce feed Reduce depth of cut Change to wet cutting 	<ul style="list-style-type: none"> Increase rake angle Select an appropriate chipbreaker Increase side cutting edge angle Increase corner radius
				
Notch wear		<ul style="list-style-type: none"> Change to more wear resistant grades P, M, K30 → 20 → 10 	<ul style="list-style-type: none"> Reduce cutting speed Reduce feed 	<ul style="list-style-type: none"> Increase rake angle Increase side cutting edge angle
				
Fracture		<ul style="list-style-type: none"> Change to tougher grades Change to thermal-shock resistant grades P, M, K10 → 20 → 30 	<ul style="list-style-type: none"> Reduce feed Reduce depth of cut Improve holding rigidity of work and tool Reduce overhang length of toolholder Improve looseness in machine 	<ul style="list-style-type: none"> Reduce rake angle Select a chipbreaker with high edge strength Increase honing width Increase side cutting edge angle Select larger shank size Increase corner radius
				
Chipping		<ul style="list-style-type: none"> Change to tougher grades P, M, K10 → 20 → 30 	<ul style="list-style-type: none"> Reduce cutting speed Reduce feed Reduce depth of cut Improve holding rigidity of work and tool Reduce overhang length of toolholder Improve looseness in machine 	<ul style="list-style-type: none"> Reduce rake angle Select a chipbreaker with high edge strength Increase honing width Increase side cutting edge angle Select larger shank size
				
Flaking		<ul style="list-style-type: none"> Change to tougher grades P, M, K10 → 20 → 30 	<ul style="list-style-type: none"> Reduce cutting speed Reduce feed 	<ul style="list-style-type: none"> Reduce rake angle Increase corner radius Increase honing width
				
Plastic deformation		<ul style="list-style-type: none"> Change to more wear resistant grade P, M, K30 → 20 → 10 	<ul style="list-style-type: none"> Reduce cutting speed Change to appropriate feed Reduce depth of cut Supply cutting fluid in adequate volume 	<ul style="list-style-type: none"> Increase relief angle Increase rake angle Reduce corner radius Reduce side cutting edge angle Select a free-cutting chipbreaker
				
Chip welding		<ul style="list-style-type: none"> Use a grade which has a low tendency to adhere to Workpiece material Cemented carbide → Coated carbide or cermet 	<ul style="list-style-type: none"> Increase cutting speed Increase feed Change to water-insoluble cutting fluid Change to wet cutting 	<ul style="list-style-type: none"> Increase rake angle Select a free-cutting chipbreaker Decrease honing width
				
Built-up edge		<ul style="list-style-type: none"> Use a grade which has a low tendency to adhere to Workpiece material Cemented carbide → Coated carbide or cermet 	<ul style="list-style-type: none"> Increase cutting speed Increase feed Change to water-insoluble cutting fluid Change to wet cutting 	<ul style="list-style-type: none"> Increase rake angle Select a free-cutting chipbreaker Decrease honing width
				
Thermal cracking		<ul style="list-style-type: none"> Change to tougher grades Change to thermal-shock resistant grades P, M, K10 → 20 → 30 	<ul style="list-style-type: none"> Reduce cutting speed Reduce feed Change to dry cutting Supply cutting fluid in adequate volume Reduce depth of cut Change to water-insoluble cutting fluid 	<ul style="list-style-type: none"> Increase rake angle Select a free-cutting chipbreaker Decrease honing width
				

User's Guide- Technical Reference

Turning Tools

Problem	Cause	Countermeasure	
		Tool	Cutting conditions and others
Deteriorated surface roughness	<ul style="list-style-type: none"> Increased tool wear 	<ul style="list-style-type: none"> Select a more wear resistant grade Use an insert with a larger rake angle Use an insert with a larger nose radius Use a more lightly honed insert Use an insert of closer tolerance (from M class to G class) 	<ul style="list-style-type: none"> Select a proper feed Decrease the cutting speed Select a freer-cutting chipbreaker type Use a cutting fluid
	<ul style="list-style-type: none"> Edge chipping 	<ul style="list-style-type: none"> Use a tougher grade Select a chipbreaker with strong cutting edges Use a largely honed insert Increase the side cutting edge angle Use a larger shank size 	<ul style="list-style-type: none"> Decrease the depth of cut Decrease the feed Use a more rigid machine Improve the holding rigidity of the tool and workpiece Shorten the overhang of the toolholder Improve the machine looseness
	<ul style="list-style-type: none"> Chip welding Built-up-edge 	<ul style="list-style-type: none"> Select a grade with less affinity with the Workpiece material Use an insert with a larger rake angle Select a freer-cutting chipbreaker type Use a more lightly honed insert Use an insert of closer tolerance (from M class to G class) 	<ul style="list-style-type: none"> Increase the cutting speed Increase the feed Use a water-insoluble cutting fluid Use a cutting fluid
	<ul style="list-style-type: none"> Vibration and chatter 	<ul style="list-style-type: none"> Use a tougher grade Use an insert with a larger rake angle Select a freer-cutting chipbreaker type Use an insert with a smaller nose radius Decrease the side cutting edge angle Use a more lightly honed insert Use a larger shank size 	<ul style="list-style-type: none"> Use a proper cutting speed Decrease the feed Decrease the depth of cut Improve the holding rigidity of the tool and workpiece Shorten the overhang of the toolholder Improve the machine looseness
Deteriorated dimensional accuracy	<ul style="list-style-type: none"> Improper insert accuracy 	<ul style="list-style-type: none"> Use an insert of closer tolerance (from M class to G class) 	
	<ul style="list-style-type: none"> Incomplete engagement of tool and workpiece 	<ul style="list-style-type: none"> Use an insert with a larger rake angle Select a freer-cutting chipbreaker type Use an insert with a smaller nose radius Use a more lightly honed insert 	<ul style="list-style-type: none"> Improve the holding rigidity of the tool and workpiece Shorten the overhang of the toolholder Improve the machine looseness
Burr occurrence	<ul style="list-style-type: none"> Unsuitable cutting speed 		<ul style="list-style-type: none"> Decrease the cutting speed Increase the feed Use a cutting fluid
	<ul style="list-style-type: none"> Worn tool or improper cutting edge geometry 	<ul style="list-style-type: none"> Use a harder grade Use an insert with a larger rake angle Select a freer-cutting chipbreaker type Increase the relief angle Use an insert with a smaller nose radius Decrease the side cutting edge angle Use a more lightly honed insert 	
Edge breakout	<ul style="list-style-type: none"> Improper cutting speed 		<ul style="list-style-type: none"> Decrease the feed Decrease the depth of cut
	<ul style="list-style-type: none"> Worn tool or improper cutting edge geometry 	<ul style="list-style-type: none"> Use a harder grade Use an insert with a larger rake angle Select a freer-cutting chipbreaker type Increase the side cutting edge angle Use an insert with a larger nose radius Use a more lightly honed insert Use a larger shank size 	<ul style="list-style-type: none"> Improve the holding rigidity of the tool and workpiece Shorten the overhang of the toolholder Improve the machine looseness
Fuzzy surface finish	<ul style="list-style-type: none"> Improper cutting conditions 		<ul style="list-style-type: none"> Increase the cutting speed Select a proper feed Use a water-insoluble cutting fluid Use a cutting fluid
	<ul style="list-style-type: none"> Worn tool or improper cutting edge geometry 	<ul style="list-style-type: none"> Use a harder grade. Select a grade with less affinity with the Workpiece material Use an insert with a larger rake angle Select a freer-cutting chipbreaker type Use a more lightly honed insert 	

User's Guide- Technical Reference

Chipbreakers

Chip controllability

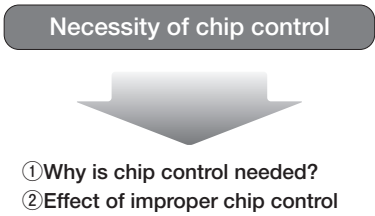

Necessity of chip control (Problems and effects)

Problems	Effects
1. Scattering of chips and coolant. 2. Wrapping around the workpiece and the tool. 3. Accumulation on the tool, jig, and machining facilities.	1. Disturbs unmanned and automated machining. 2. Disturbs high-speed and high-efficiency machining. 3. Degrades finished surface. 4. Threatens operator's safety. 5. Reduced operation rate.

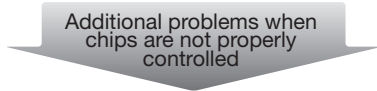

① Why is chip control needed?





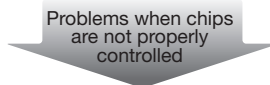

For making a product from a workpiece, removed objects produced by a tool which is set to cut to a specified depth with the relative motion of the tool and the workpiece.

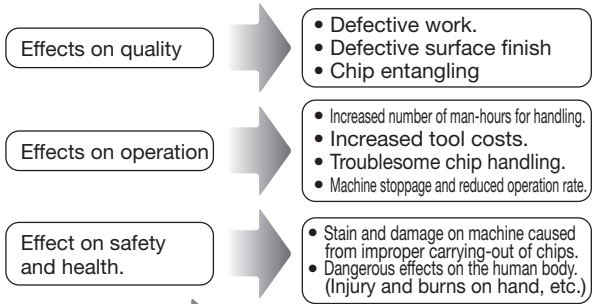

② Effect of improper chip control

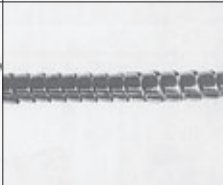

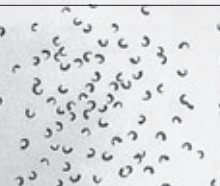
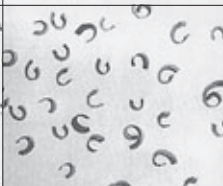
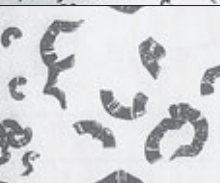
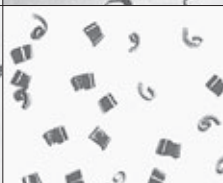
Classification	Chip shape		Description of chip shape	Acceptability	Effect	
	Depth of cut: small	Depth of cut: large				
Shape A			Chips irregularly entangled	Not acceptable	<ul style="list-style-type: none"> • Wrapping around the tool or workpiece or accumulation around the cutting point, hindering cutting • Possible damage to the machined surface 	
Shape B			Long continuous spiral chips $l > 2"$	↑ Acceptable ↓	<ul style="list-style-type: none"> • Bulky during transport in the automatic line • May be preferred when one operator handles one machine 	
Shape C			Short spiral chips $l < 2"$		<ul style="list-style-type: none"> • Smooth chip flow • Difficult to scatter • Favorable shape 	
Shape D			"C" or "9" shaped chips (Around one coiling)		<ul style="list-style-type: none"> • Favorable shape if not scattering • Not bulky and easy to transport 	
Shape E			Excessively broken chips. Thin pieces or connected in a form of wave as shown in the figure left		Not acceptable	<ul style="list-style-type: none"> • Readily scattering. If scattering is the only trouble, it may be acceptable because the chip cover, etc. may be used. • Tend to cause chatter, causing harm on the finished surface roughness or tool life.

Chipbreakers

Factors affecting chip control

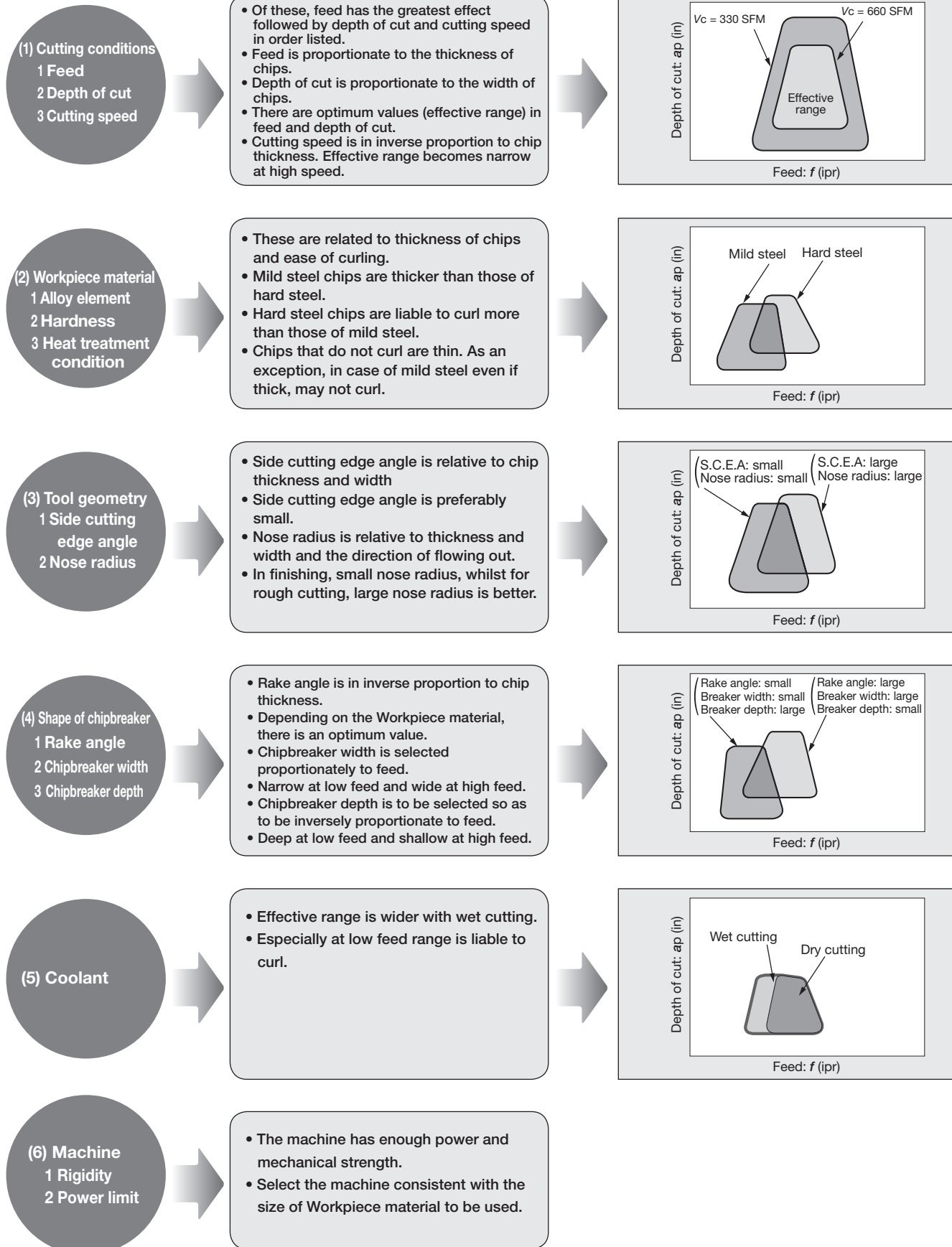

Milling tools

Nomenclature for face milling cutter

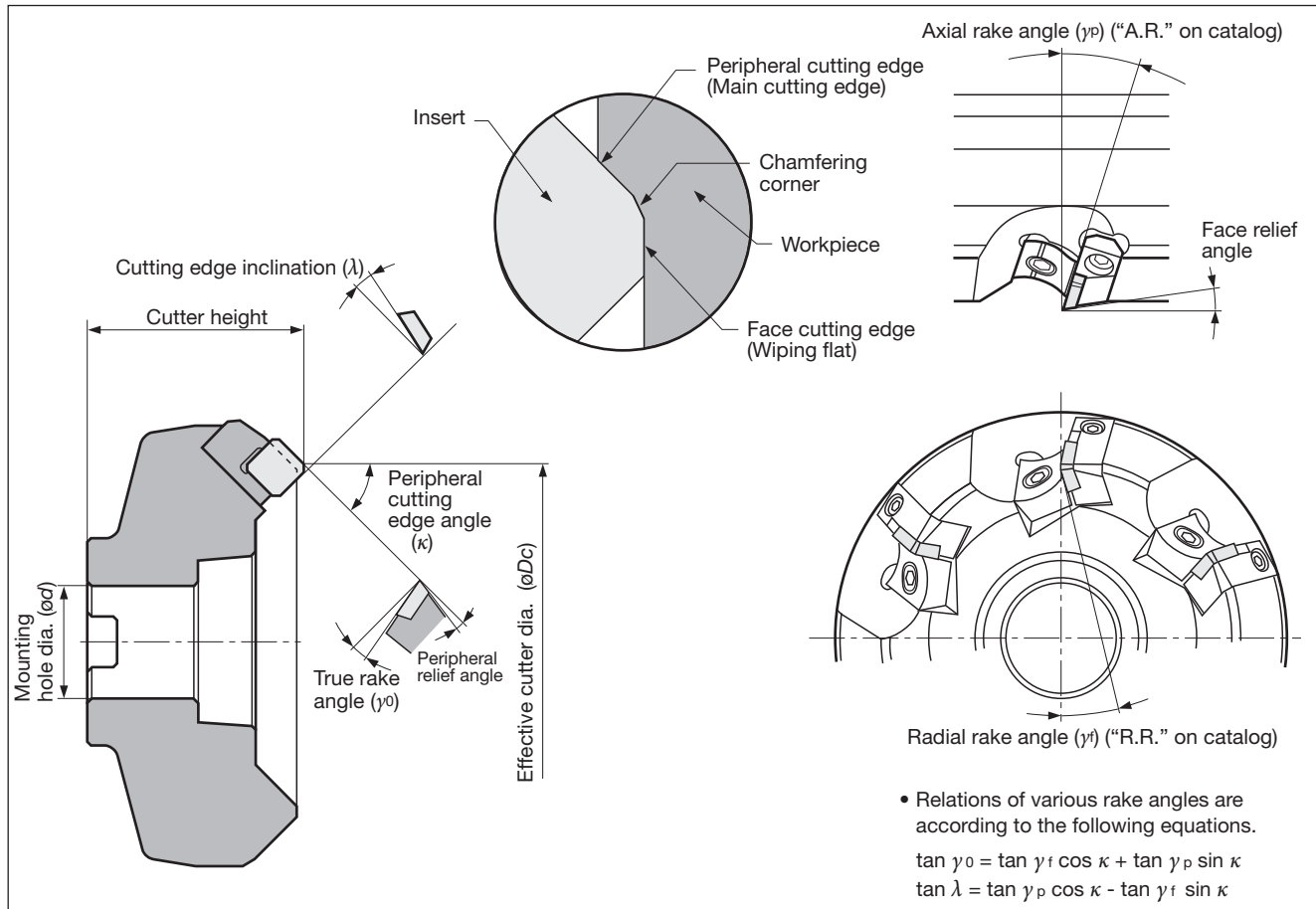

Cutter geometry and applications

Condition		Rake angle combination and applicability		
		Negative-Negative	Negative-Positive	Positive-Positive
Shapes of cutting edge	γ_p (A.R.)	-	+	+
	γ_r (R.R.)	-	-	+
	γ_0	-	+	+
Workpiece material	Carbon steels, alloy steels (< 300HB)	△	◎	◎
	Stainless steels (< 300HB)	×	◎	○
	Die steels (< 300HB)	△	◎	○
	Cast irons Ductile cast irons	◎	○	○
	Aluminum alloys	×	○	◎
	Copper and its alloys	×	○	◎
	Titanium and its alloys	×	○	○
	Hardened steels (40 ~ 55HRC)	○	○	×
Features		· Higher cutting edge strength · Many usable corners of inserts	· Excellent chip removal · Higher cutting edge strength and Freer cutting action	· Most excellent cutting action
Typical examples of mills		TGN4200 DoPent	TAW13 TME4400 TMD4400	THF4000 THE4000

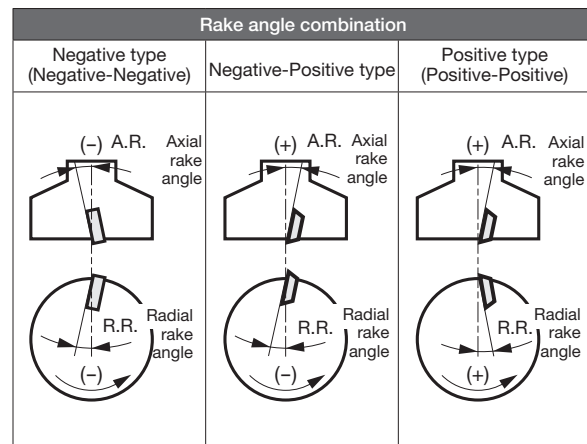

User's Guide- Technical Reference

Milling tools

Calculation formulas for milling

●Cutting speed

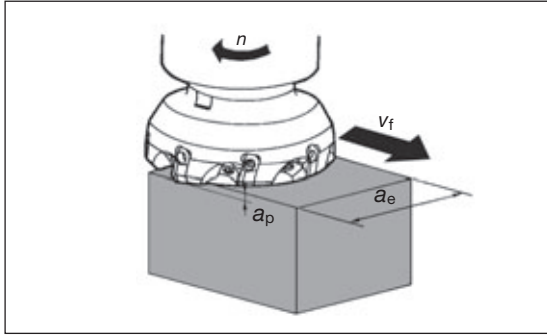

●Cutting speed (Calculated from number of revolutions)

$$SFM = \frac{RPM \times \phi D}{3.82}$$

SFM: Surface feet per minute
RPM: Revolutions per minute
 ϕD : Tool diameter

●Number of revolution (Calculated from cutting speed)

$$RPM = \frac{SFM \times 3.82}{\phi D}$$

SFM: Surface feet per minute
RPM: Revolutions per minute
 ϕD : Tool diameter

●Feed speed and feed per tooth

$$V_f = f_z \times z \times n$$

V_f : Feed speed (in/min)
 f_z : Feed per tooth (ipt)
 z : No. of teeth of the cutter
 n : Number of revolutions (min^{-1})

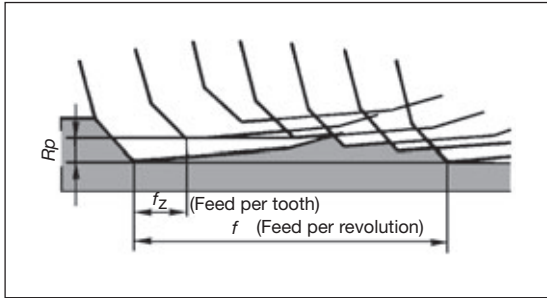

Feed speed is relative speed of cutter and Workpiece material and in the normal milling machine, it is the table speed. In milling, the feed per tooth is very important. The recommended cutting condition is expressed by V_c and f_z and using the above equation calculate n and V_f and input in the machine.

●Cutting time on face milling

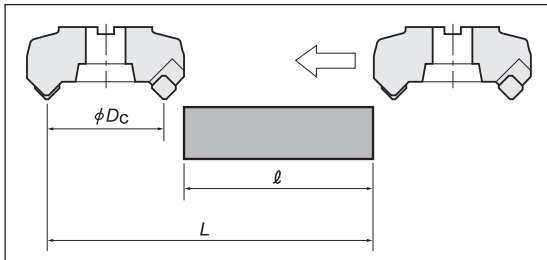

$$T = \frac{L}{V_f}$$

T : Cutting time (min)
 L : Total table feed length.
(l : Workpieces length (in) + ϕD_c : Effective cutter diameter (in))
 V_f : Feed speed (in/min)

Depth of cut and width of cut

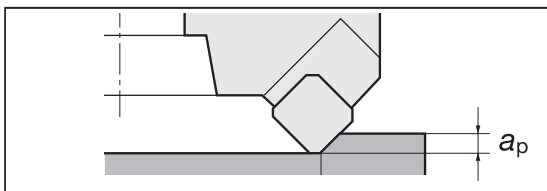

●Depth of cut

Determine by required allowance for machining and capacity of the machine. In case of mill, there are cutting limits according to shape and size of the insert. Please see spec in the catalog.

a_p : Depth of cut (in)

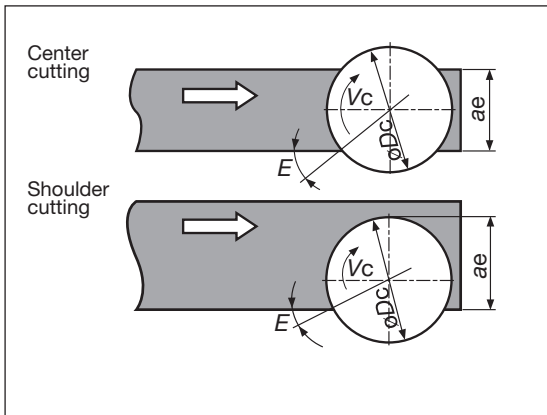

●Width of cut and engagement angle

There is an appropriate engage angle depending on the cutter diameter, cutting position, Workpiece material, etc., and ordinarily the values in the table below are used as a guide.

ϕD_c : Cutter diameter (in)
 E : Engage angle
 a_e : Width of cut (in)

Center cutting			Shoulder cutting		
Workpiece material	Appropriate E	Cutter dia. and a_e	Workpiece material	Appropriate E	Cutter dia. and a_e
Steel	~ 42°	$a_e \approx \frac{2}{3} \phi D_c$	Steel	~ 30°	$a_e \approx \frac{3}{5} \phi D_c$
Cast iron	~ 53°	$a_e \approx \frac{4}{5} \phi D_c$	Cast iron	~ 40°	$a_e \approx \frac{3}{4} \phi D_c$

Milling tools

Surface roughness in milling

(1) Theoretical surface roughness

Theoretical surface roughness is calculated by the following formulae (The calculation theory is essentially similar to a turning operation where the nose radius on a single point tool affects its surface roughness):

● Insert with nose radius r_ϵ

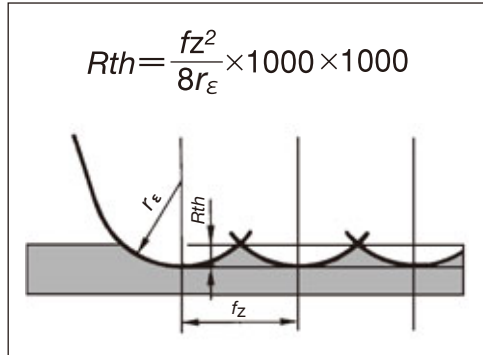

● Insert with no nose radius r_ϵ

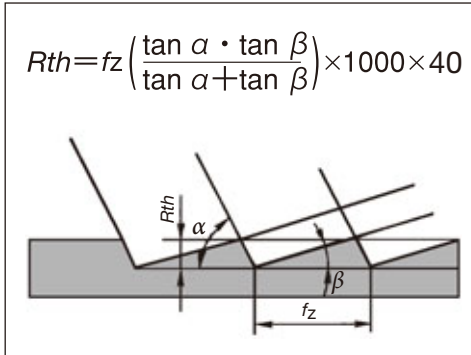

R_{th} : Theoretical roughness (μinch)

f_z : Feed per tooth (ipt)

r_ϵ : Corner radius (in)

α : Corner angle

β : Face cutting edge angle

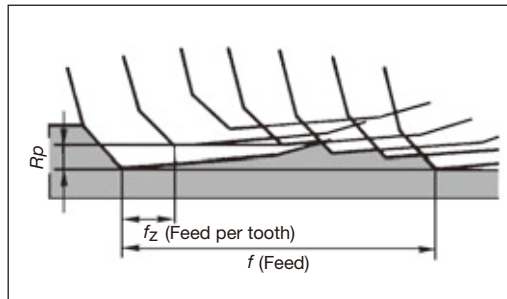

(2) Actual surface roughness

A facemill cutter in practice is composed of multiple point cutting edges and is prone to create uneven peaks, or an axial runout error (R_p) on cutting edges.

One or two cutting edges being non-coplanar to the rest invariably create the dominant mark on a face-milled surface, producing periodic patterns corresponding to the feed per revolution f (ipr) superimposing on the feed per tooth f_z (ipt).

Improving surface roughness

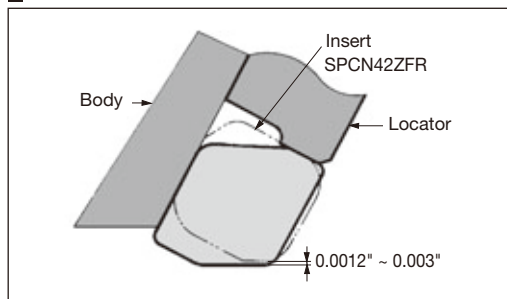

To improve surface roughness, minimize axial runout and set the feed per revolution (mm/rev) at no more than 90% of the wiper length. To further improve the machining efficiency and surface quality, use wiper inserts.

(1) In case of ordinary mill

Use wiper insert as shown in the figure at left.

(2) Use of super finish mill for finishing.

- Use of combination mills with finishing insert such as TFD4400-A and TFP4000IA ($a_p < 0.039$).
- Use of super finish mill for finishing such as NMS cutters and SFP4000 etc.

User's Guide- Technical Reference

Milling Tools

Calculating power requirement

$$P_c = \frac{k_c \times a_p \times a_e \times v_f}{330}$$

(HP)

Because practical power requirements depend on the type of mill (proportional to the true rake angle) and the motor efficiency of the machine used, the result calculated from the above formula should be considered as a rough guide.

P_c : Net power requirement (HP)

k_c : Specific cutting force (KPI)
[Refer to the Table below]

a_p : Depth of cut (in)

a_e : Width of cut (in)

v_f : Feed speed (in/min)

Values of specific cutting force (k_c)

Workpiece material (JIS)	Tensile strength lb/in ² (PSI)	Value of specific cutting force on feed per tooth k_c (KSI)				
		0.004 (ipr)	0.006 (ipr)	0.008 (ipr)	0.012 (ipr)	0.016 (ipr)
SS400	75,420	312	290	276	254	239
S55C	111,679	286	270	261	255	235
SCM435	105,878	355	341	319	287	248
SKT4	(HB352)	294	292	263	244	231
SC450	75,420	393	367	350	325	307
FC250	(HB200)	241	210	191	167	149
Al (Si)	29,008	96	84	76	67	59
Brass	72,519	158	139	127	110	99

Values of cutting force (k_c)

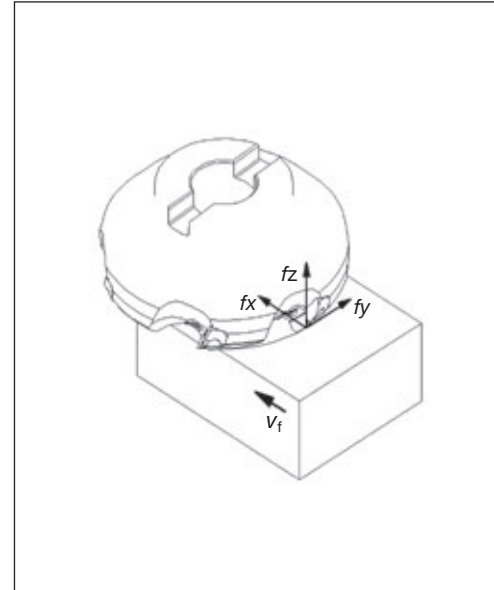
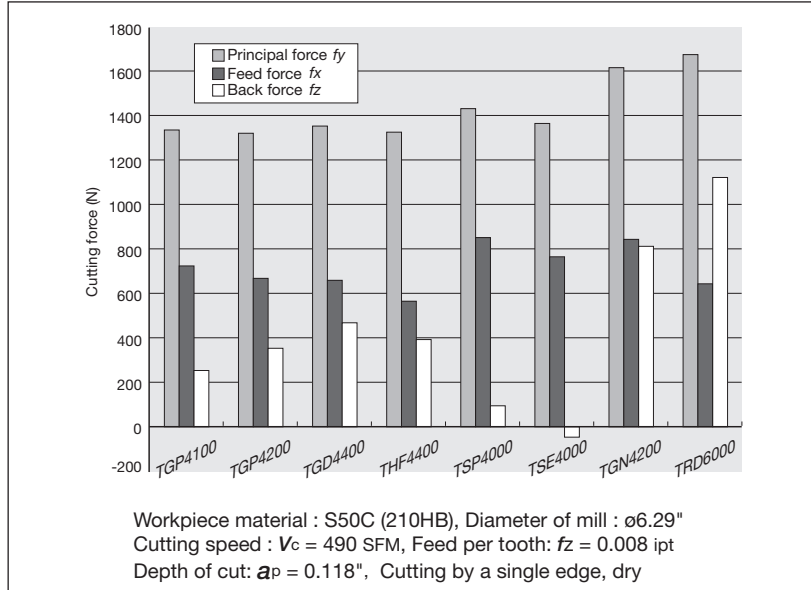

Conversion from cutting speed to number of revolutions

(unit : min⁻¹)

Cutter diameter ϕD_c (in.)	Cutting speed (v_c) SFM												
	33	98	164	328	410	492	656	984	1640	2625	3281	6562	13123
0.394	318	955	1,592	3,184	3,980	4,777	6,369	9,554	15,923	25,477	31,847	63,694	127,388
0.472	265	796	1,326	2,653	3,317	3,980	5,307	7,961	13,269	21,231	26,539	53,078	106,157
0.630	199	597	995	1,990	2,488	2,985	3,980	5,971	9,952	15,923	19,904	39,808	79,617
0.787	159	477	796	1,592	1,990	2,388	3,184	4,777	7,961	12,738	15,923	31,847	63,694
0.984	127	382	636	1,273	1,592	1,910	2,547	3,821	6,369	10,191	12,738	25,477	50,955
1.181	106	318	530	1,061	1,326	1,592	2,123	3,184	5,307	8,492	10,615	21,231	42,462
1.260	99	298	497	995	1,244	1,492	1,990	2,985	4,976	7,961	9,952	19,904	39,808
1.378	90	272	454	909	1,137	1,364	1,819	2,729	4,549	7,279	9,099	18,198	36,396
1.575	79	238	398	796	995	1,194	1,592	2,388	3,980	6,369	7,961	15,923	31,847
1.969	63	191	318	636	796	955	1,273	1,910	3,184	5,095	6,369	12,738	25,477
2.480	50	151	252	505	631	758	1,011	1,516	2,527	4,044	5,055	10,110	20,220
3.150	39	119	199	398	497	597	796	1,194	1,990	3,184	3,980	7,961	15,923
3.937	31	95	159	318	398	477	636	955	1,592	2,547	3,184	6,369	12,738
4.921	25	76	127	254	318	382	509	764	1,273	2,038	2,547	5,095	10,191
6.299	19	59	99	199	248	298	398	597	995	1,592	1,990	3,980	7,961
7.874	15	47	79	159	199	238	318	477	796	1,273	1,592	3,184	6,369
9.843	12	38	63	127	159	191	254	382	636	1,019	1,273	2,547	5,095
12.402	10	30	50	101	126	151	202	303	505	808	1,011	2,022	4,044

Note: In this table, the effects of centrifugal force on the rotating balance of the tool and the toolholder, flying risk of cutter parts, and limited value of toolholder destruction are not considered. Therefore, when using the tool at high speeds, be sure to observe the specified condition range.

User's Guide- Technical Reference

Milling Tools

Trouble shooting in face milling

Trouble	Possible causes	Countermeasures
Rapid wear of cutting edge	<ul style="list-style-type: none"> Improper insert grade selection (Insufficient wear resistance) 	<ul style="list-style-type: none"> P30 (Cemented carbide) → Cermet, coated grade (For steels) K10 (Cemented carbide) → Coated grade (For cast irons)
	<ul style="list-style-type: none"> Excessive cutting speed 	<ul style="list-style-type: none"> Select cutting speed suited for Workpiece material and insert grade
	<ul style="list-style-type: none"> Inadequate feed 	<ul style="list-style-type: none"> Use standard cutting condition in catalog as guide
Rapid chipping of cutting edge	<ul style="list-style-type: none"> Improper Insert grade selection (Insufficient toughness) 	<ul style="list-style-type: none"> Cermet → P30 (For steels), K10 → K20 (For cast irons)
	<ul style="list-style-type: none"> Cutting hard material and unfavorable surface condition 	<ul style="list-style-type: none"> Decrease cutting speed Use cutter with strong cutting edge
	<ul style="list-style-type: none"> Excessive feed 	<ul style="list-style-type: none"> Proper selection of feed conditions, using recommended cutting conditions in catalog as guide
	<ul style="list-style-type: none"> Excessive pressure applied on cutting edge 	<ul style="list-style-type: none"> Proper selection of engaging angle
	<ul style="list-style-type: none"> Machining superalloys 	<ul style="list-style-type: none"> Use a negative-positive type cutter with large corner angle
Fracturing	<ul style="list-style-type: none"> Cracking due to thermal shock 	<ul style="list-style-type: none"> Select insert grade of stronger thermal shock resistance Decrease cutting speed
	<ul style="list-style-type: none"> Continuous use of excessively worn insert 	<ul style="list-style-type: none"> Shorten replacement standard time of insert
	<ul style="list-style-type: none"> Cutting hard material 	<ul style="list-style-type: none"> Use cutter with stronger cutting edge Use cutter of larger corner angle
	<ul style="list-style-type: none"> Obstruction to chip flow Recutting of chips after chip welding 	<ul style="list-style-type: none"> Use cutter with better chip expulsion Select insert grades difficult for chips to adhere Cemented carbides → cermets, coated grades Use air blow
	<ul style="list-style-type: none"> Excessively slow cutting, too fine feed 	<ul style="list-style-type: none"> Select cutting speed and feed optimized for insert grade and Workpiece material
Excessive chip welding or build-up on cutting edge	<ul style="list-style-type: none"> Cutting soft material such as aluminum, copper, mild steel 	<ul style="list-style-type: none"> Use cutter with large rake angle
	<ul style="list-style-type: none"> Cutting stainless steel 	<ul style="list-style-type: none"> P30 → coated grades (AH130, AH3135)
	<ul style="list-style-type: none"> Use of cutter with negative rake or too small rake angle 	<ul style="list-style-type: none"> Use cutter with large rake angle
Rough finish	<ul style="list-style-type: none"> Effect of built-up edge 	<ul style="list-style-type: none"> Increase cutting speed Appropriate cutting depth (finish allowance) Change insert grade For steels : P → coated → cermet For cast irons : K → coated
	<ul style="list-style-type: none"> Effect of face cutting edge run out 	<ul style="list-style-type: none"> Proper installing of inserts Use insert of high dimensional accuracy Cleaning of insert pocket
	<ul style="list-style-type: none"> Continuous use of excessively worn insert 	<ul style="list-style-type: none"> Shorten replacement standard time of insert
	<ul style="list-style-type: none"> Remarkable feed marks 	<ul style="list-style-type: none"> Feed per revolution to be set within flatland width Use wiper insert type cutter such as T/EAW13 Use cutter exclusively for finishing
Chattering	<ul style="list-style-type: none"> Unstable clamping of workpiece 	<ul style="list-style-type: none"> Check clamping method of workpiece
	<ul style="list-style-type: none"> Cutting of welded construction of thin steel plate 	<ul style="list-style-type: none"> Use cutter of large rake angle and small corner angle
	<ul style="list-style-type: none"> Excessive cutting condition 	<ul style="list-style-type: none"> Re-examine allowable chip removal rate according to motor HP
	<ul style="list-style-type: none"> Face milling of narrow width workpiece 	<ul style="list-style-type: none"> Use cutter of small cutter diameter and with many teeth
	<ul style="list-style-type: none"> Too many simultaneous cutting teeth engagement 	<ul style="list-style-type: none"> Reduce No. of teeth or use irregular pitch cutter

Solid Carbide Endmills

Part details

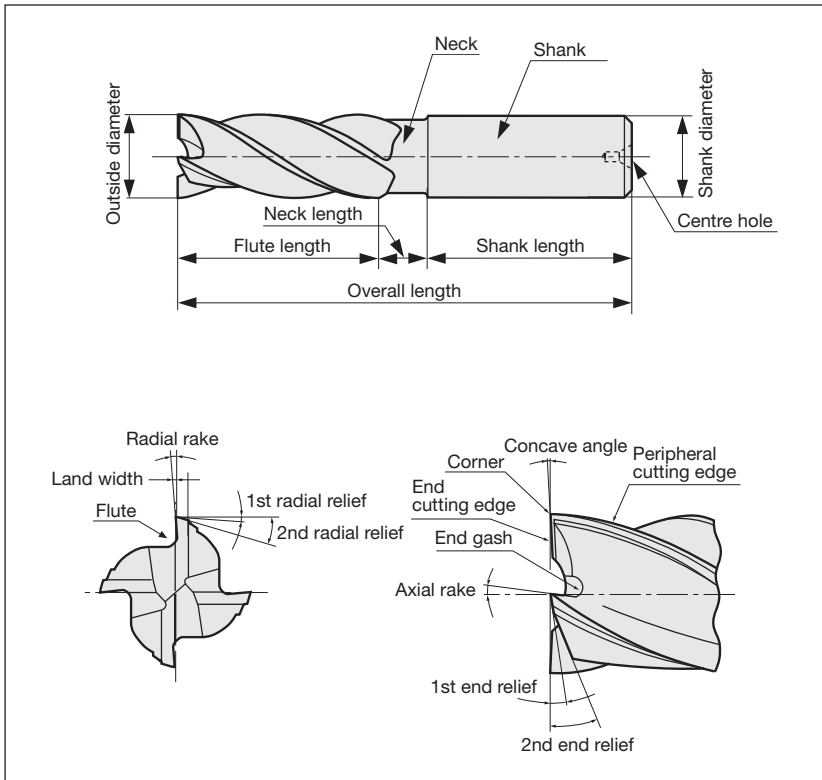

Types

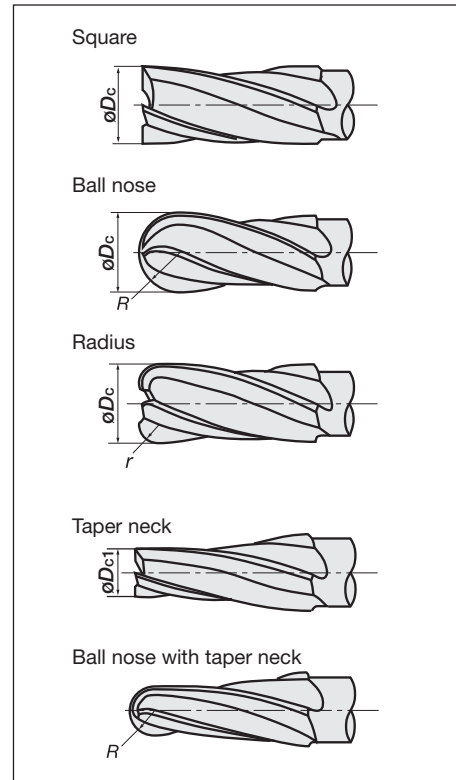

Cutting condition of Endmills

● Cutting speed

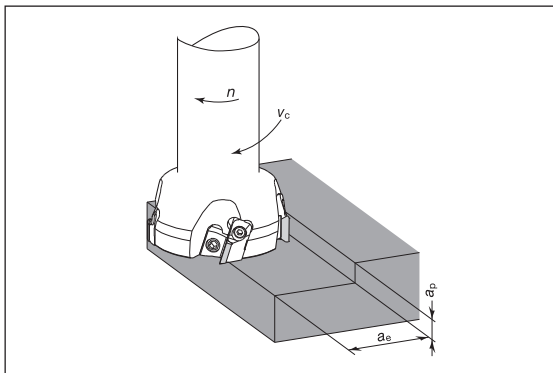

● Cutting speed (Calculated from number of revolutions)

$$SFM = \frac{RPM \times \phi D}{3.82}$$

SFM: Surface feet per minute
RPM: Revolutions per minute
 ϕD : Diameter

● Number of revolution (Calculated from cutting speed)

$$RPM = \frac{SFM \times 3.82}{\phi D}$$

SFM: Surface feet per minute
RPM: Revolutions per minute
 ϕD : Diameter

● Feed speed and feed per tooth

$$V_f = f_z \times z \times n$$

V_f : Feed speed (in/min)
 f_z : Feed per tooth (ipt)
 z : No. of teeth of the endmills
 n : Number of revolutions (min^{-1})

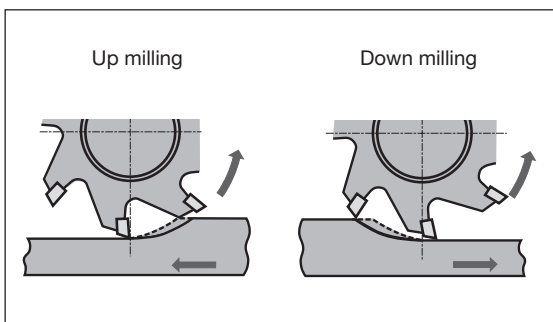

● Cutting

The necessary capacity of the machine is limited by the length of cut edge of the endmill.

● Up milling and down milling

Down milling generally produces better tool life and surface roughness.

In case of cast iron sand inclusion or welding surface, up milling is recommended.

Solid Carbide Endmills

Regrinding procedures of solid carbide endmill

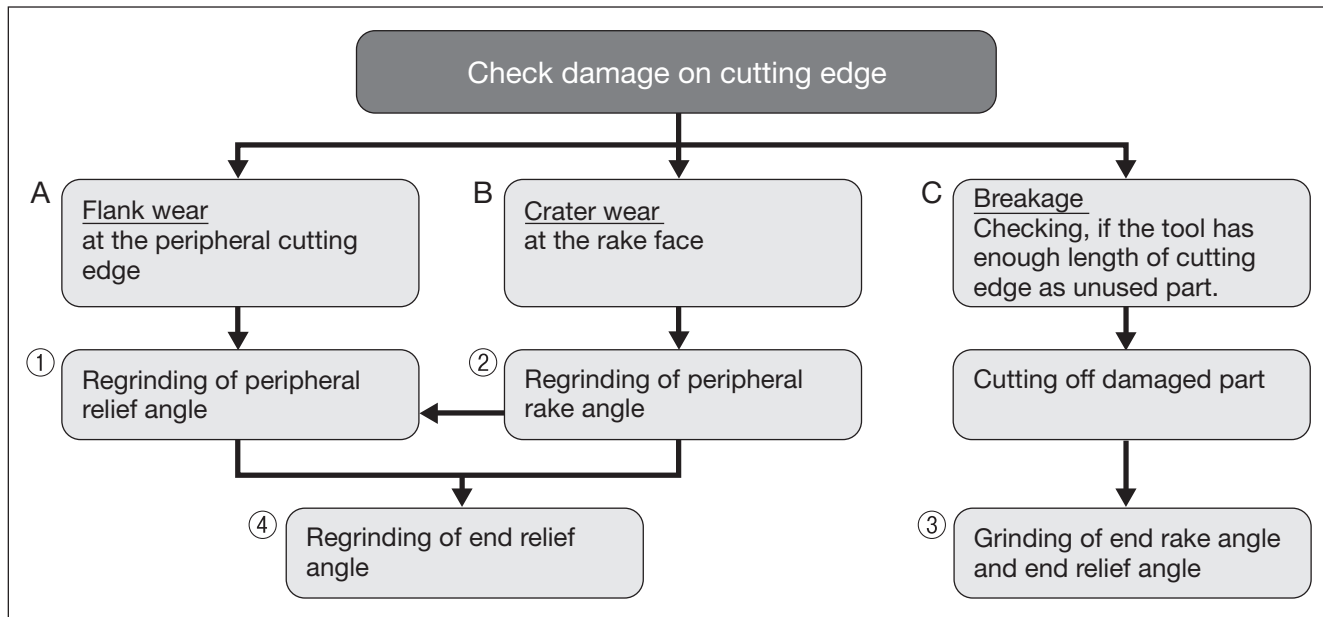

1 Regrinding of end relief angle

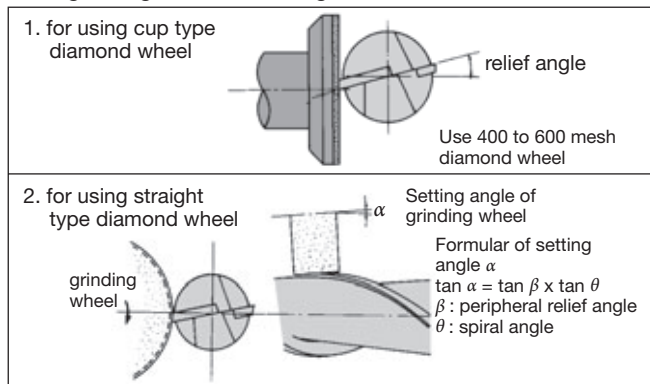

2 Regrinding of peripheral rake angle

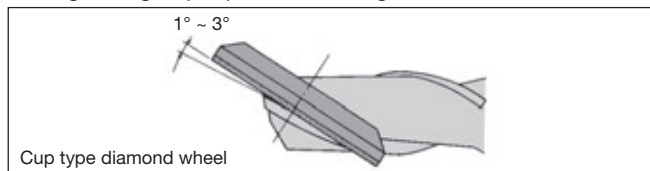

3 Regrinding of end rake angle (End gash)

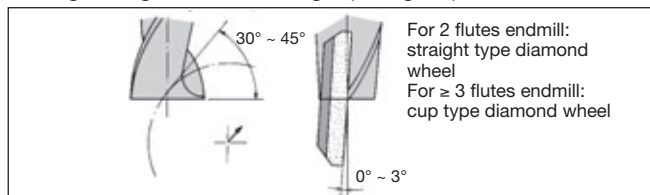

4 Regrinding of end relief angle

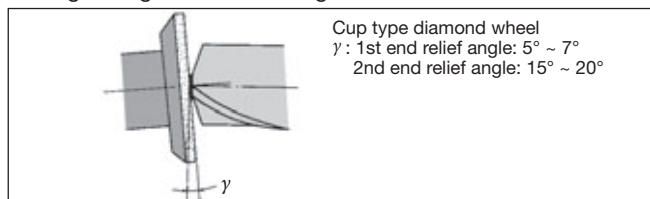

Notice of regrinding

- If, after checking the damage of the cutting edge, the damage is as case "A" or "B" of the flow chart, the tool must be reground. Too much damage of the cutting edge requires too much stock removal and thus reduces tool life.
- Please use diamond grinding wheel.
- Peripheral relief angle must be ground between 18° and 10°. Relief angle of small diameter cutters for aluminum machining must be a large degree.
- First check if "C" in flow chart can be adapted for the case of coated endmill or not. If procedure "C" can be adapted for regrinding, tool life after the grinding would be more improved than new one. The reason is remaining coated layer of cutting edge and shorter tool length will keep much higher rigidity of the tool than before regrinding.
- Please check run out of peripheral cutting edge, face cutting edge, with Vee block after regrinding. The value of the run out must be controlled within 0.0004".

Notice for regrinding of ball nose endmill

- Regrinding of relief angle only is available. The dimension of nose radius will be smaller after grinding.
- Honing of cutting edge is necessary after regrinding.

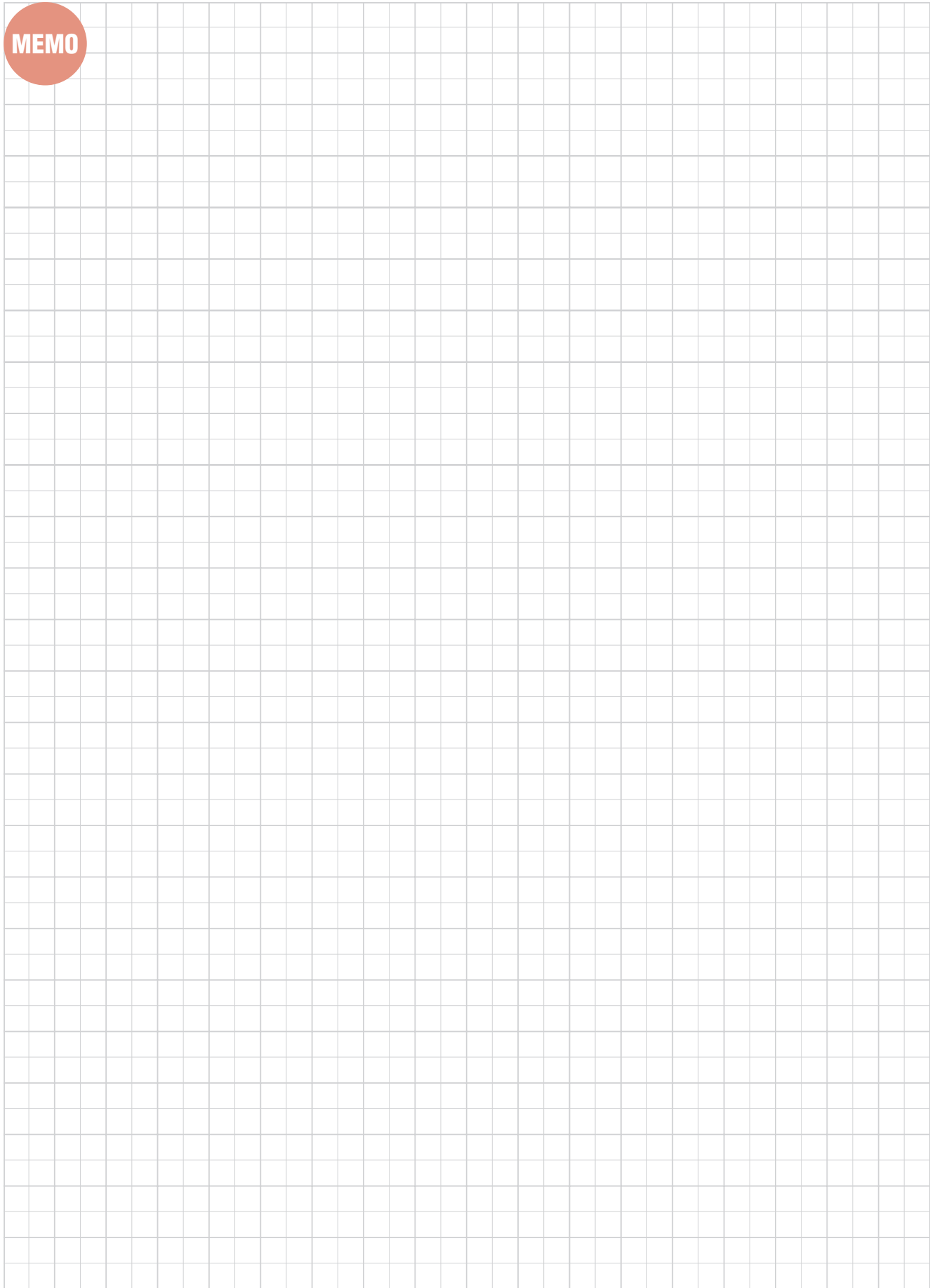

MEMO

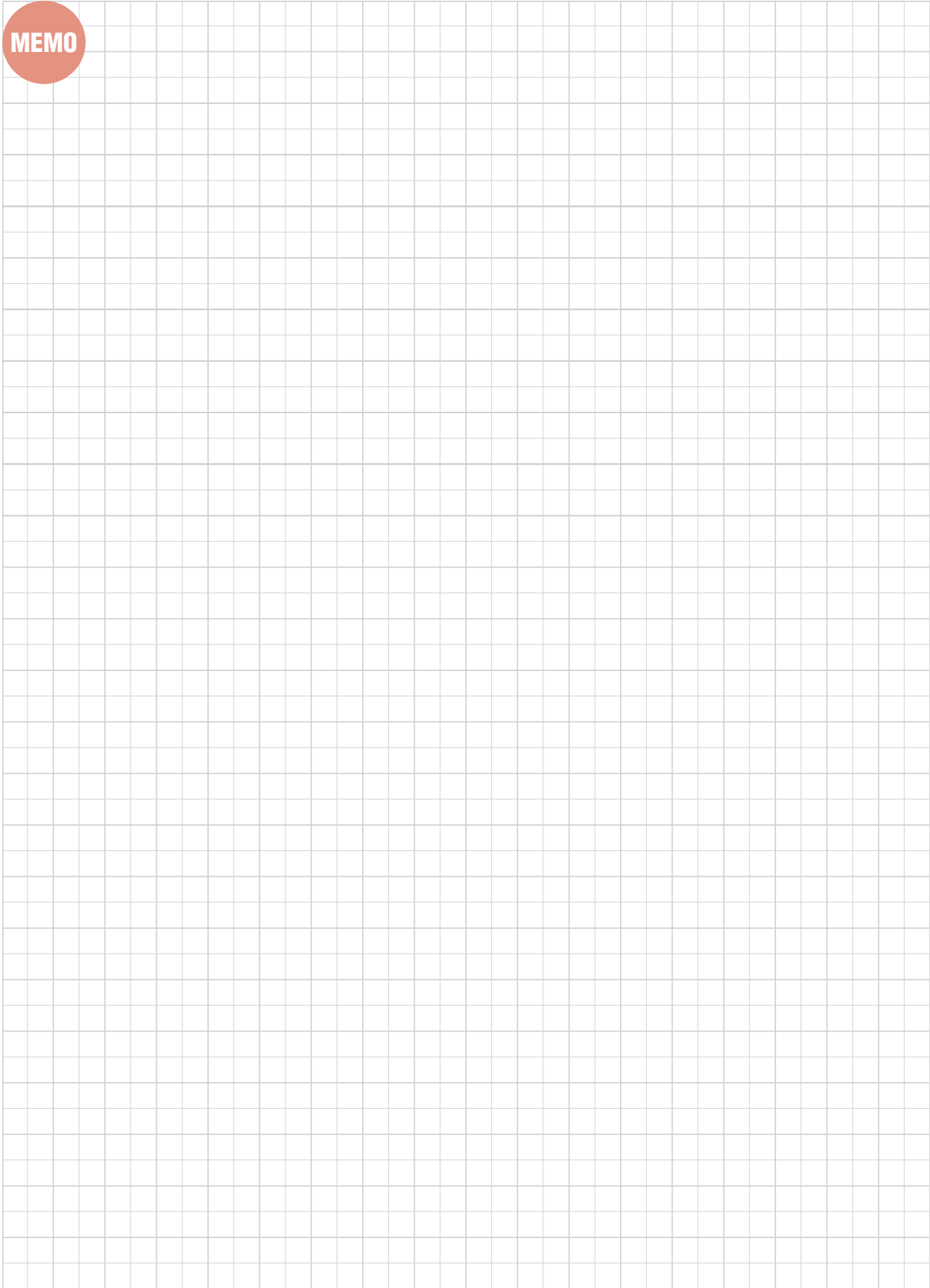

User's Guide- Technical Reference

Drilling Tools

Nomenclature for solid carbide drills

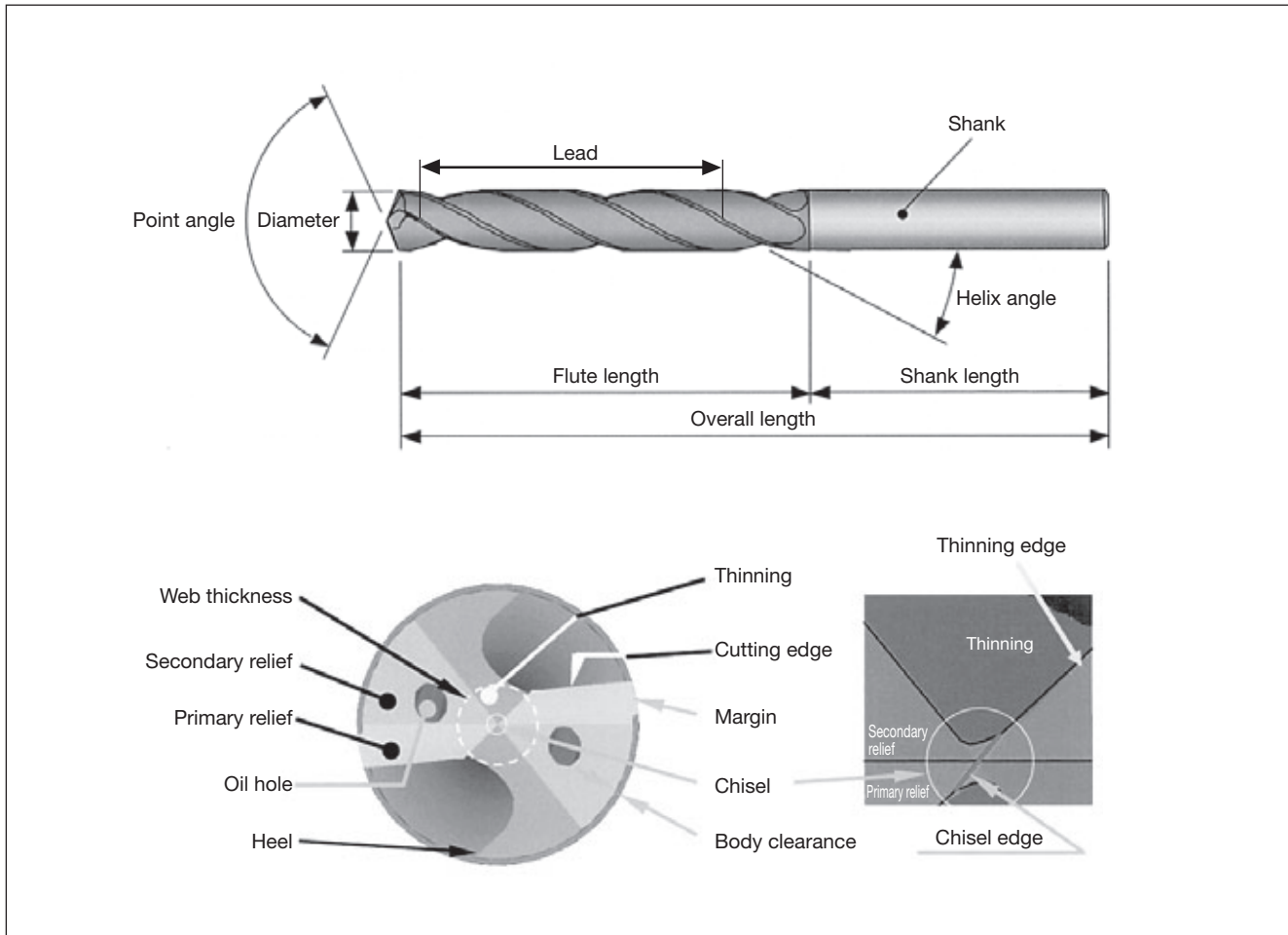

Cutting forces and power requirement

● Twist drill

Power requirement

$$P_C = K \phi D_c^2 n \quad (0.647 + 17.29f) \times 10^{-6}$$

(kW) 1kw = 1.34 HP

Thrust force

$$T_C = 570 K \phi D_c f^{0.85}$$

(N)

Torque

$$M_C = \frac{K \phi D_c^2 (0.630 + 16.84f)}{100}$$

(N·m)

- P_C : Power requirement (HP)
- T_C : Thrust force (N)
- M_C : Torque (N·m)
- ϕD_C : Drill diameter (mm)
- f : Feed (mm/rev)
- n : No. of revolutions (min^{-1})
- K : Material constant... Refer to the Table at right

● Material constant compensating for power requirement and thrust force

Workpiece material	Tensile strength		Brinell hardness (HB)	Material constant (K)
	MPa (N/mm ²)	Kgf/mm ²		
Cast iron	210	21	177	1.00
Cast iron	280	28	198	1.39
Cast iron	350	35	224	1.88
Aluminum	250	25	100	1.01
Low carbon steel (JIS S20C)	550	55	160	2.22
Free cutting steel (JIS SUM32)	620	62	183	1.42
Manganese steel (JIS SMn438)	630	63	197	1.45
Nickel chromium steel (JIS SNC236)	690	69	174	2.02
4115 steel Cr0.5, Mo0.11, Mn0.8	630	63	167	1.62
Chromium molybdenum steel (JIS SCM430)	770	77	229	2.10
Chromium molybdenum steel (JIS SCM440)	940	94	269	2.41
Nickel chromium molybdenum steel (JIS SNM420)	750	75	212	2.12
Nickel chromium molybdenum steel (JIS SNM625)	1,400	140	390	3.44
Chromium vanadium steel				
Cr0.6, Mn0.6, V0.12	580	58	174	2.08
Cr0.8, Mn0.8, V0.1	800	80	255	2.22

User's Guide- Technical Reference

Drilling Tools

Cutting edge failure of solid carbide drills

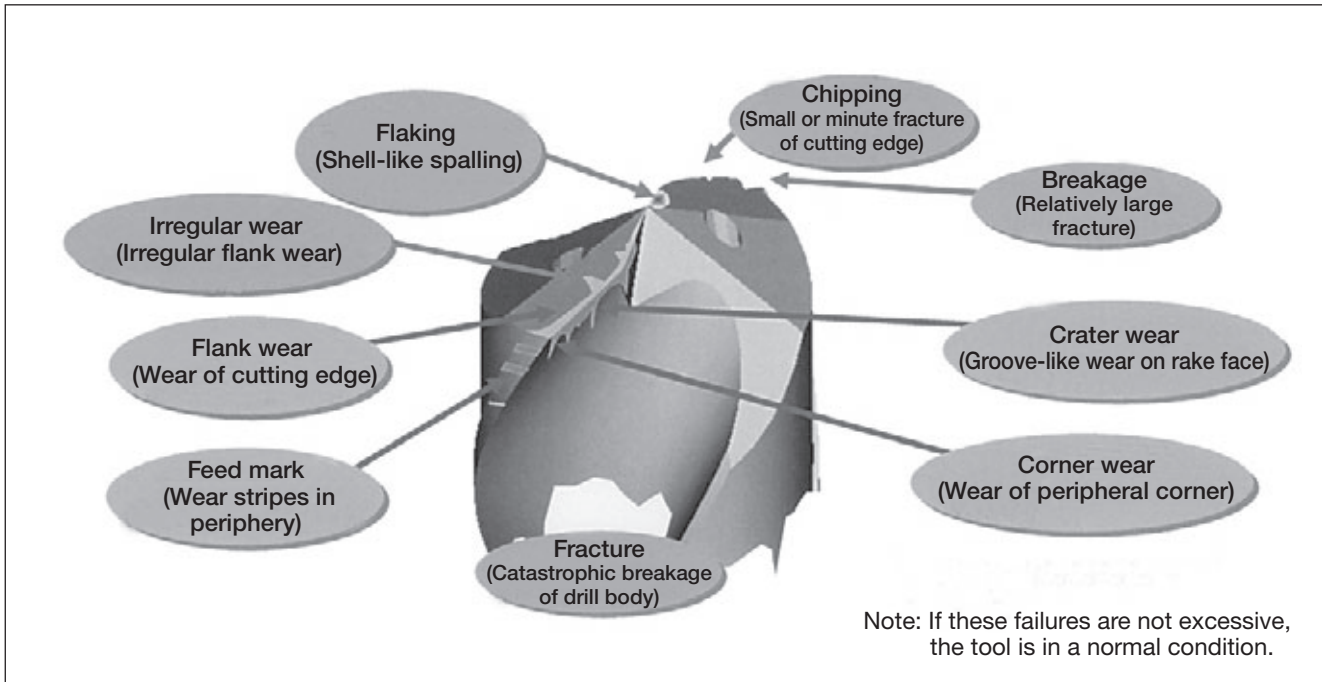

Change of chip shapes in drilling

● Change of chip shapes relating to cutting conditions

Photographs below show the change of chip shapes relating to change of the feed and the cutting speed. These chip shapes are all well controlled in a proper condition range.

When the speed and feed are low, the chip shows whitish color and the tail of the chip tends to lengthen gradually. In contrast, as the speed or the feed increases, the chip tends to increase in brightness and becomes a compact shape with a short tail. These changes in the shape depend on the cutting temperature. As the temperature increases, chips tend to be broken.

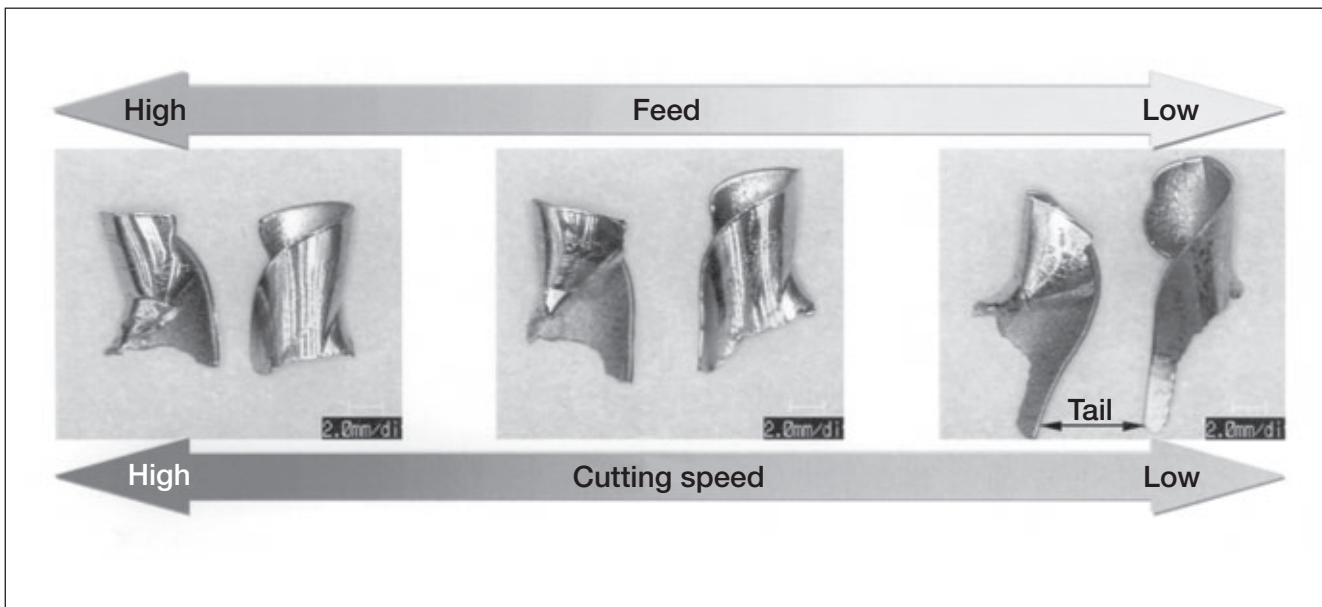

User's Guide- Technical Reference

Drilling Tools

Troubleshooting for solid carbide drills

Problem		Cause	Countermeasure	
Abnormal wear	Relief surface	Inappropriate cutting speed	<ul style="list-style-type: none"> •Increase the cutting speed by 10 % within standard conditions if abnormal wear is around center. •Lower the cutting speed by 10 % within standard conditions if abnormal wear is on the periphery. 	
		Inappropriate cutting fluid	<ul style="list-style-type: none"> •Check the filter. •Use the cutting fluid superior in lubricity. (Increase the dilution rate) 	
	Margin	Inappropriate cutting speed	<ul style="list-style-type: none"> •Lower the cutting speed by 10 %. 	
		Regrinding timing, insufficient reground amount	<ul style="list-style-type: none"> •Shorten the regrinding timing. 	
		Insufficient rigidity of the machine and workpiece	<ul style="list-style-type: none"> •Change the clamp method to the one with rigidity. 	
		Insufficient drill rigidity	<ul style="list-style-type: none"> •Use smallest possible overhang. 	
		Inappropriate cutting fluid	<ul style="list-style-type: none"> •Check the filter. •Use the cutting fluid superior in lubricity. (increase the dilution rate) 	
Intermittent cutting when entering	<ul style="list-style-type: none"> •Avoid interruption at entry and exit. •Lower the feed by about 50 % during entering into and leaving from the workpiece. 			
Chipping and fracture	Chisel section (center of drill cutting edge)	Insufficient rigidity of the drill	<ul style="list-style-type: none"> •Reduce the drill overhang as much as possible. •Increase the feed at entry when the low speed feed is selected in standard cutting condition range. •Use a bushing or a center drill. 	
		Insufficient rigidity of the machine and workpiece	<ul style="list-style-type: none"> •Change the clamp method to the one with rigidity. 	
		Inappropriate entry into the workpiece	<ul style="list-style-type: none"> •Avoid interruption at entry into the workpiece. •Lower the feed by 10 % at entry. 	
		High workpiece hardness	<ul style="list-style-type: none"> •Lower the feed by 10 %. 	
	Peripheral cutting edge	Inappropriate honing	<ul style="list-style-type: none"> •Check if honing has been made to the center of cutting edge. 	
		Insufficient drill rigidity	<ul style="list-style-type: none"> •Lower the cutting speed by 10 %. •Increase the feed at entry when the low speed feed is selected in standard cutting condition range. 	
			Inappropriate drill mounting accuracy	<ul style="list-style-type: none"> •Check the run out accuracy after drill installation. (0.0012" or less)
			Insufficient machinery and workpiece rigidity	<ul style="list-style-type: none"> •Change the clamp method to the one with rigidity. •Lower the feed during entering into and leaving from the workpiece.
	Margin	Inappropriate honing	<ul style="list-style-type: none"> •Check if honing has been made to the cutting edge periphery. 	
		Insufficient machine and workpiece rigidity	<ul style="list-style-type: none"> •Change the clamp method to the one with rigidity. 	
		Insufficient drill rigidity	<ul style="list-style-type: none"> •Use smallest possible overhang. •Use a bushing or center drill. 	
		Regrinding timing and insufficient amount of reground stock	<ul style="list-style-type: none"> •Shorten the regrinding timing. 	
	Intermittent cutting when entering or exiting the cut	<ul style="list-style-type: none"> •Avoid interruption at entry and exit. •Lower the feed by about 50 % during entering into and leaving from the workpiece. 		
		<ul style="list-style-type: none"> •Check the failure mode condition before breakage and find out the wear and chip countermeasures. 		
<ul style="list-style-type: none"> •Lower the feed by about 50 % during entering into and leaving from the workpiece. 				
Breakage	Tendency to cause chipping or develop abnormal wear	<ul style="list-style-type: none"> •Check the failure mode condition before breakage and find out the wear and chip countermeasures. 		
	Chip packing in the drill flutes	<ul style="list-style-type: none"> •Review the cutting conditions. •For internal coolant supply, raise the supply pressure of cutting fluid. •Use peck feed for deep holes. 		
	Insufficient machine output	<ul style="list-style-type: none"> •Review the cutting conditions. •Use the machine with high power. 		
Insufficient hole accuracy	Insufficient rigidity of the machinery and workpiece	<ul style="list-style-type: none"> •Change to the clamp method with rigidity 		
	Inappropriate drill installation accuracy	<ul style="list-style-type: none"> •Check the run out accuracy of drill mounting. (0.0012" or less) 		
	Chip packing in the flutes.	<ul style="list-style-type: none"> •Review the cutting conditions. •Raise the cutting oil supply pressure. •Use peck-feed for deep holes. 		
	Inappropriate edge sharpening accuracy	<ul style="list-style-type: none"> •Check the edge shape accuracy. 		
Prolonged chips	Inappropriate cutting conditions	<ul style="list-style-type: none"> •Increase the feed by 10 % within standard conditions. 		
	Inappropriate honing	<ul style="list-style-type: none"> •Provide the appropriate honing. 		
	Cutting edge with chipping or breakage	<ul style="list-style-type: none"> •Lower the cutting speed by 10 %. 		

Drilling Tools

Nomenclature for Indexable drill

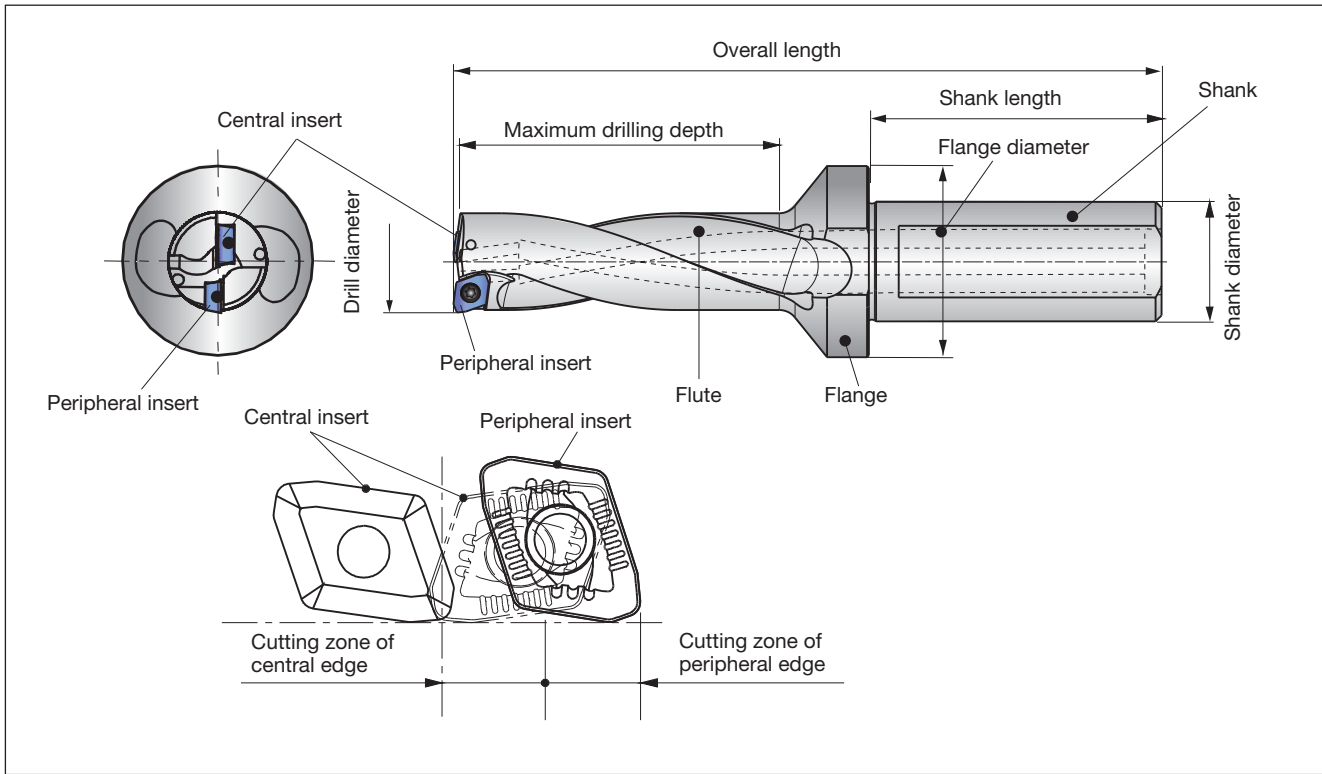

Calculation formulas for Indexable drill

●Cutting speed

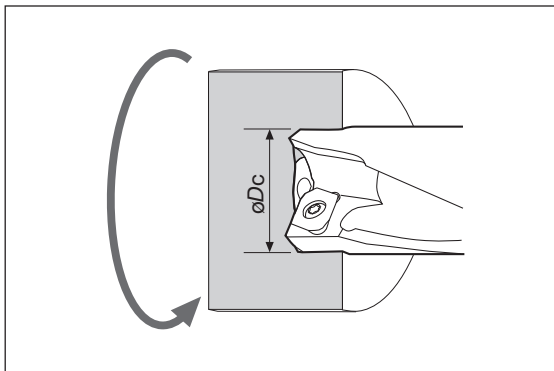
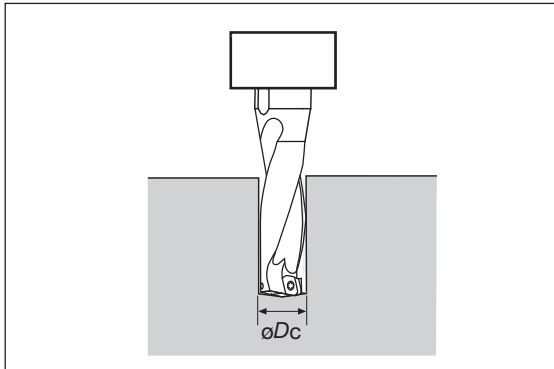

●When calculating cutting speed from number of revolutions: (Drilling formulas)

$$SFM = \frac{RPM \times \phi D}{3.82}$$

SFM: Surface feet per minute
RPM: Revolutions per minute
 ϕD : Diameter

●When calculating required number of revolutions from cutting speed: (Drilling formulas)

$$RPM = \frac{SFM \times 3.82}{\phi D}$$

SFM: Surface feet per minute
RPM: Revolutions per minute
 ϕD : Diameter

●When calculating cutting speed from number of revolutions: (Where the workpiece rotates.)

$$v_c = \frac{\pi \times \phi D_c \times n}{1000}$$

v_c : Cutting speed (SFM)
 ϕD_c : Drilling diameter (in)
 n : Number of revolution (min^{-1})
 $\pi \approx 3.14$

●When calculating required number of revolutions from cutting speed: (Where the workpiece rotates.)

$$n = \frac{1000 \times v_c}{\pi \times \phi D_c} \quad (\text{min}^{-1})$$

●Calculation of feed speed

$$v_f = f \times n$$

v_f : Feed speed (in/min)
 f : Feed (ipr)
 n : Number of revolution (min^{-1})

User's Guide- Technical Reference

Drilling Tools

Chip shapes

● Chip shape produced with central insert

- A conical coil shape whose apex point coincides with the rotating center of the drill is the basic shape. The chips are broken into small sections with increases in feed. However, excessively high feed causes the chip to increase in thickness and develops vibration which disturbs stable machining.
- In TDX drills, ○ marked chips shown below are the most preferable shapes. This type of chip is broken into adequate lengths by centrifugal forces when used in tool-rotating condition. On the other hand, when used in work-rotating condition such as on a lathe, a continuously long chip is often produced without entangling.

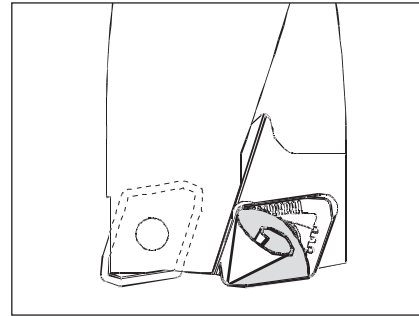

● Relation between chip shapes and feeds (In the case of central insert)

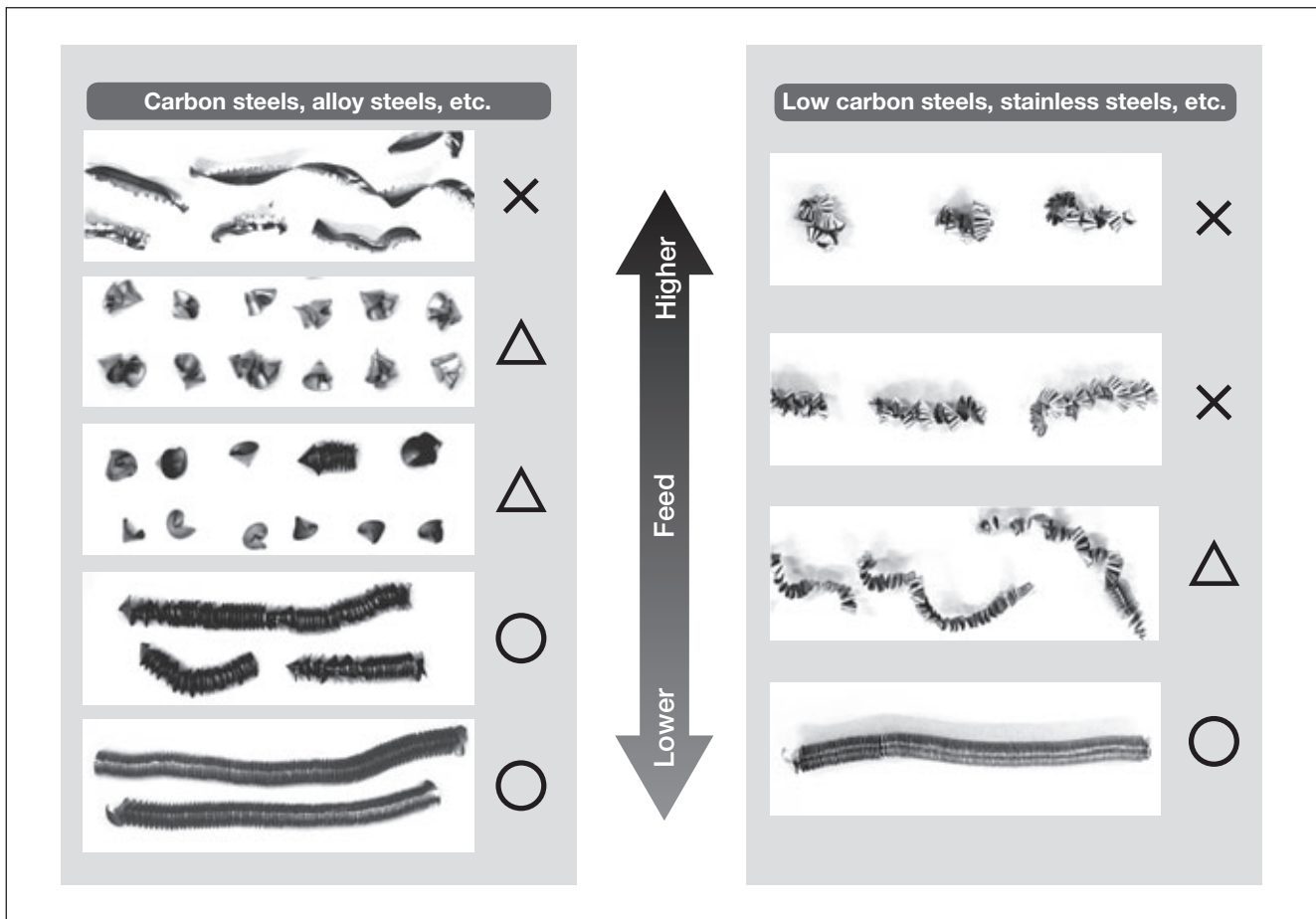

● Example of chip shape in work-rotating applications (In the case of central insert)

($\phi 1.024''$, 1045, $V_c = 330$ SFM, $f = 0.004$ ipr)

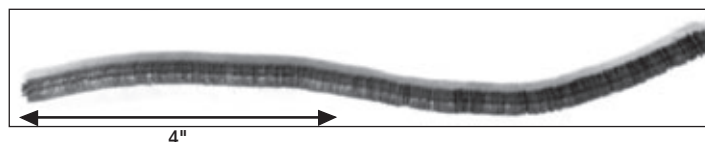

User's Guide- Technical Reference

Drilling Tools

● Chip shape produced with peripheral insert

- Chip problems such as entangling are mainly caused by chips produced with the peripheral insert. These problems are dependent on the types of Workpiece material and the cutting conditions.
- As shown below, when the feed is extremely low, the chips jump over the chipbreaker groove and the continuously long chips may wrap around the drill body.
- When the feed is too high, the chips increase in thickness and can not be curled.
- Therefore, it is important to select proper cutting conditions to suit the machining so that well controlled chips will be formed.

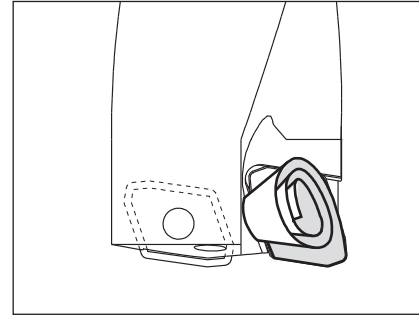

Medium to high carbon steels, alloy steels, etc.

As shown below, several turns of coil are an ideal shape. As the feed increases, the curl radius and the number of turns tend to decrease.

● Typical chip shapes of general steels



● Variation of chip shapes relating to feeds

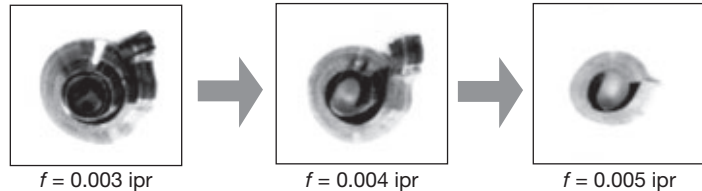

Stainless steels, low-carbon steels, low-alloy steels, etc.

- When machining long-chip materials such as stainless steels and mild steels, the wrong selection of cutting conditions results in chip entangling and tool breakage at worst. Therefore, cutting conditions should be carefully selected.
- “C” shaped, continuous coils of several to ten turns having adequately divided lengths are the ideal shape.

● Ideal chip shapes

	Stainless steel (JIS SUS 304) ($\phi 0.866"$, $V_c = 330$ SFM, $f = 0.004$ ipr)	Mild steel (JIS SS400) ($\phi 0.866"$, $V_c = 530$ SFM, $f = 0.003$ ipr)
DS chipbreaker		
DJ chipbreaker		

For machining stainless steels or low carbon steels, DS chipbreaker is recommended. When using a TDX drill in tool-rotating condition, DS chipbreaker produces compact chips and allows more stable machining than DJ chipbreaker. When using it in work-rotating condition, DS chipbreaker provides outstanding affect on chip control.

User's Guide- Technical Reference

Drilling Tools

● Chip shapes which tend to entangle and remedies against them

① Apple-peel-like chips

These chips are often produced in machining mild steels or low-carbon steels at low-speeds and low-feeds.

Remedies

Increase the cutting speed in stages by 20% within the range of standard cutting conditions. If there is no effect, increase the feed by about 10 % as the cutting speed is raised by 20%.



Apple-peel-like chips (Without curling)

② Short-lead chips

These chips are often produced in machining stainless steels at low-feeds and tend to entangle to the tool in spite of short length.

Remedies

Increase the feed by about 10 %. If there is no effect, increase the cutting speed in stages by 10% within the range of standard cutting conditions.

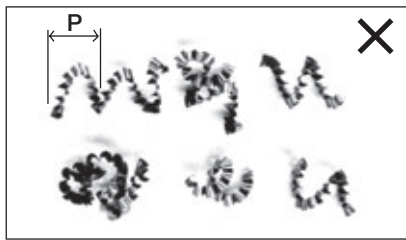

Continuously curled "C" shape chips with short lead (P).

③ Very long chips

Often produced in machining mild steels or low-carbon steels under improper cutting conditions.

Remedies

Increase the cutting speed in stages by 20% within the range of standard cutting conditions. If there is no effect, decrease the feed by about 10 % as the cutting speed is raised by 20%.

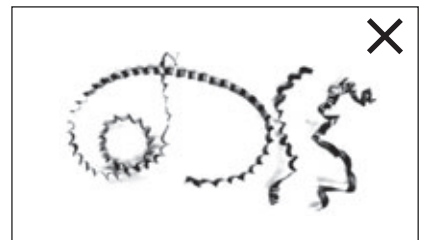

Continuously coiled long chips

Cutting forces

The charts below show a guideline for cutting forces. Use TDX drills on a machine with ample power and sufficient rigidity.

● Guidelines for cutting forces

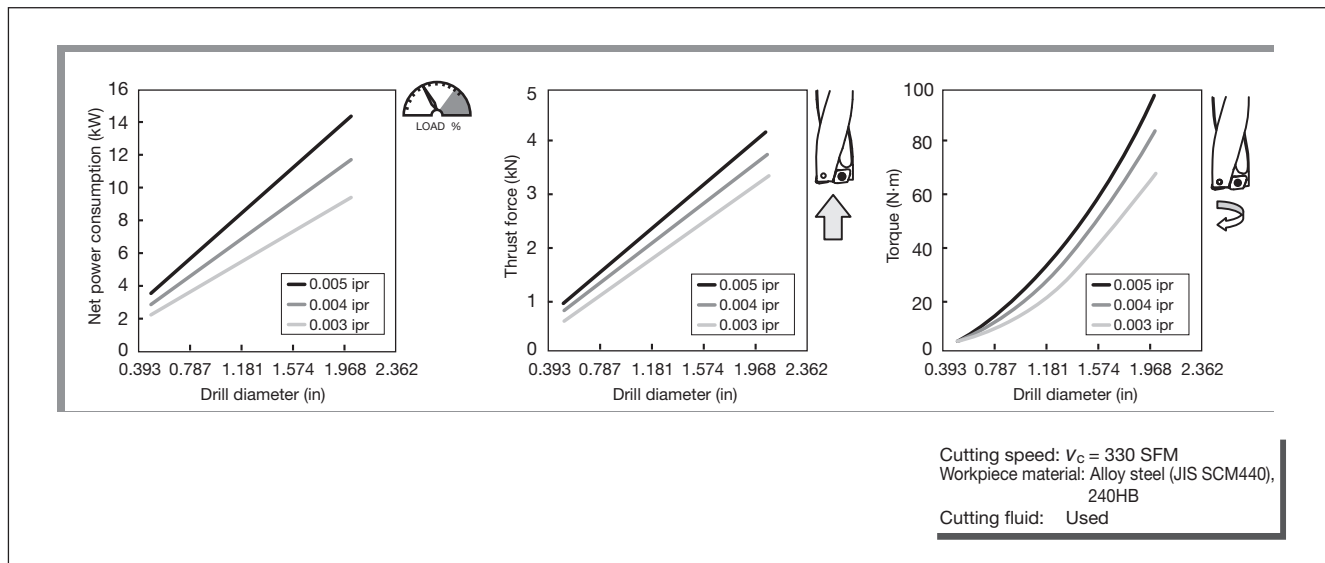

User's Guide- Technical Reference

Drilling Tools

Troubleshooting for indexable drills

Problem		Cause	Countermeasure	
Abnormal wear	Central cutting edge	Relief surface	Inappropriate cutting conditions	<ul style="list-style-type: none"> ● Increase the cutting speed by 10 % within standard conditions. ● Lower the feed by 10 %.
	Peripheral cutting edge	Relief surface	Inappropriate cutting conditions	<ul style="list-style-type: none"> ● Increase the cutting speed by 10 % within standard conditions. ● When the feed is extremely low or high, set up it within standard conditions.
		Common	Relief surface	Varieties and supply of cutting fluid
	Vibration in drilling			<ul style="list-style-type: none"> ● Change to the machine with higher torque. ● Change to the clamp method with rigidity. ● Change the drill setting method.
	Unsuitable for selection of grade		● Change the grade to high wear resistant.	
	Looseness of screws		● Tighten the screw.	
	Crater	Cutting heat is too high	Excessive chip welding	<ul style="list-style-type: none"> ● Change to internal cutting fluid supply from external one. ● Increase the supply rate of the cutting fluid. (Higher than 10 liter/min.) ● Lower the feed by 20 % within standard conditions. ● Lower the cutting speed by 20 % within standard conditions.
				<ul style="list-style-type: none"> ● Lower the feed by 20 % within standard conditions. ● Lower the cutting speed by 20 % within standard conditions.
		Chipbreaker	Chip packing	<ul style="list-style-type: none"> ● Increase the cutting speed by 20% and lower the feed by 20% within standard conditions. ● Raise the fluid pressure (for higher than 1.5 MPa).
	Chipping and fracture	Central cutting edge	The rotation center of drill	Misalignment for workpiece rotation
Large offset				● Check the manual and use the tool in the allowable offset range.
No flatness of machined surface				<ul style="list-style-type: none"> ● Flatten the entry surface in pre-machining. ● Set the feed for lower than 0.002 ipr in rough surface area.
High feed				● Lower the feed by 20 ~ 50 % within standard conditions.
Peripheral cutting edge		Peripheral corner area	Using inserts in excess of tool-life	● Exchange the corner or the insert before the nose wear reaches 0.012".
			No flatness of machined surface	<ul style="list-style-type: none"> ● Flatten the entry surface in pre-machining. ● Set the feed for lower than 0.002 ipr at rough surface area.
			The existence of interrupted area	● Set the feed for lower than 0.002 ipr in interrupted area.
			Using a chipped corner	● Confirm the corner when exchanging inserts.
Common		The unused corner area and cutting edge	High hardness of workpiece	<ul style="list-style-type: none"> ● Increase the cutting speed by 20 % and lower the feed by 20 % within standard conditions. ● Raise the fluid pressure (for higher than 1.5 MPa).
			Chip packing	● Lower the feed by 20 % within standard conditions.
			Machinery impact	● Change to continuous feed in case of pick feeding.
		Contact boundary	Using inserts in excess of tool-life	● Exchange the corner or the insert before the nose wear reaches 0.012".
			Vibration in drilling	<ul style="list-style-type: none"> ● Change to the machine with higher rigidity. ● Change to the clamp method with rigidity. ● Change the drill setting method.
		Flaking	High hardness of workpiece	● Set the feed for lower than 0.002 ipr.
			Thermal impact	<ul style="list-style-type: none"> ● Change to internal cutting fluid supply from external one. ● Lower the feed by 20 % within standard conditions.
		Common	Unsuitable for selection of grade	● Change the grade to toughness.
			Looseness of screws	● Tighten the screw.

User's Guide- Technical Reference

Drilling Tools

Problem		Cause	Countermeasure	
Scratch marks on the tool	The tool periphery	Misalignment of workpiece rotation	● Set the misalignment to 0 ~ 0.008".	
		Offset machining in excess of allowable range	● Use the tool in the allowable offset range.	
		Offset direction reduced diameter of workpiece	● Set offset direction extended diameter of workpiece	
		No flatness of the entry surface	● Flatten the entry surface in pre-machining. ● Set the feed for lower than 0.002 ipr in rough surface area.	
		Chipping of peripheral cutting edge	● Exchange the insert.	
		Bend of workpiece	● Change to the clamp method with rigidity.	
		Chip packing	● Increase the cutting speed by 20 % and lower the feed by 20 % within standard conditions. ● Raise the fluid pressure (for higher than 1.5 MPa).	
Inappropriate hole accuracy	Hole diameter	Misalignment for workpiece rotation	● Set the misalignment to 0 ~ 0.008".	
		Inappropriate offset contents	● Adjust offset contents.	
		No flatness of the entry surface	● Flatten the entry surface in pre-machining. ● Set the feed for lower than 0.002 ipr at rough surface area.	
	Roughness	Bend of workpiece	● Change to the clamp method with rigidity.	
		Varieties and supply of cutting fluid	● The concentration of cutting fluid must be higher than 5 %. ● Use the cutting fluid superior in lubricity. ● Change to internal cutting fluid supply from external one.	
	Common	Inappropriate cutting conditions	● Increase the cutting speed by 20 % within standard conditions. ● Lower the feed by 20 % within standard conditions.	
		Failures of inserts	● Exchange the insert.	
		Chip packing	● Increase the cutting speed by 20 % and lower the feed by 20 % within standard conditions. ● Raise the fluid pressure (for higher than 1.5 MPa).	
	Chip control	Prolonged and twisted of chips	Looseness of screws	● Tighten the screw.
Inappropriate cutting conditions			● Work within standard conditions. ● Increase the cutting speed by 10 % within standard conditions. ● Increase the feed by 10 % within standard conditions.	
Failures of inserts			● Exchange inserts.	
Machining by external fluid supply			● Change to internal cutting fluid supply from external one. ● Work by step feed. ● Use dwell function for 0.1 sec approximately.	
Chip packing		Chips around the central cutting edge	● There is a tendency to shorten the chips when shifting to higher speed and feed.	
		Fluid supply	● Change to internal cutting fluid supply from external one. ● Raise the fluid pressure (for higher than 1.5 MPa).	
Common		Inappropriate cutting conditions	● Increase the cutting speed by 20 % and lower the feed by 20 % within standard conditions. ● Raise the fluid pressure (for higher than 1.5 MPa).	
		Large failure of drill holders	● Exchange the drill holder.	
Others		Chatter	Looseness of screws	● Tighten the screw.
			Inappropriate cutting conditions	● Lower the cutting speed by 20 % within standard conditions. ● Increase the feed by 10 % within standard conditions.
	Large wear of inserts		● Exchange the insert.	
	Vibration in drilling		● Change to the machine with higher torque rigidity. ● Change to the clamp method with rigidity. ● Change the drill setting method.	
	Machine stop	Looseness of screws	● Tighten the screw.	
		Insufficient machine power and torque	● Use the range of number of revolutions suited machine spec. Lower the feed by 20 ~ 50%.	
	Large burr	Burned inserts	● Exchange inserts before the failure becomes larger. ● Check the oil-hole plug screw is tightly screwed in place. ● Check that the fluid flows powerfully from the drill. ● Lower the cutting speed and the feed by 20 % within standard conditions.	
		Failures of inserts	● Exchange the insert.	
		Inappropriate cutting conditions	● Lower the feed by 20 ~ 50% just before leaving from the workpiece.	

User's Guide- Technical Reference

Drilling Tools

Nomenclature for gun drill

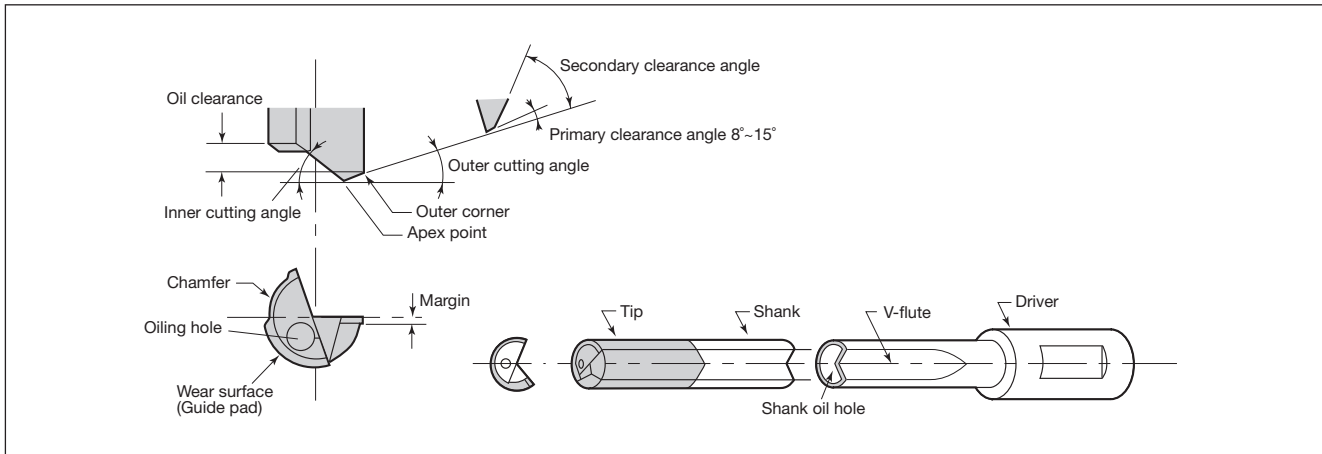

Troubleshooting in gun drilling

Problem		Cause	Countermeasure	
Breaking of drill	At entry into workpiece	Machine	Clamping the workpiece is unstable.	Clamp the workpiece firmly.
			The guide bush is apart from the workpiece surface at the entry.	Contact the guide bush closely with the workpiece.
			The machine's rapid feed is used.	Use cutting feed.
			Whipping effect occurs.	Place a whip guide at the appropriate position.
			The shape of the guide bush is not suitable.	Use the guide bush in the shape suitable for the workpiece.
	Drill	The drill is not set properly.	Set the drill with an appropriate torque, hydraulic pressure, etc.	
		Regrinding is in poor quality.	Make sure no damage is left on the drill and that the cutting edge geometry is not changed.	
	Cutting condition	The feed (f) is too high.	Use low feed.	
	Workpiece	The workpiece surface is slanted.	Use low feed.	
	During drilling	Machine	Clamping the workpiece is unstable.	Clamp the workpiece firmly.
			The shape of the guide bush is not suitable.	Modify the shape of the guide bush. See "Chip packing" for the details.
			The feed speed (V_f) varies.	Use mechanical feed.
			The number of revolutions varies (decreases).	Increase the machine power or adjust the cutting conditions.
		Drill	Abnormal damage occurs.	See "Short tool life" for the details.
Cutting condition		The feed (f) is not suitable.	Use an appropriate feed.	
Workpiece		Interrupted or cross drilling is required.	Change the tool to a standard gundrill.	
Others	Chip packing occurs.	See "Chip packing" for the details.		
At exit from workpiece	Drill	The tip is too long.	Make the tip length short.	
		The selection of the guide pads is not suitable.	Use 2 guide pads instead of 3.	
		The clearance of the coolant hole is too large.	Reduce the clearance of the coolant hole.	
	Cutting condition	The feed (f) is too high.	Use low feed.	
Workpiece	The workpiece surface is slanted.	Use low feed.		
During retracting	Machine	Clamping the workpiece is unstable.	Clamp the workpiece firmly.	
	Cutting condition	Burnishing torque (cutting power) is increased due to reduced hole diameter.	Reduce cutting speed (V_c).	

User's Guide- Technical Reference

Drilling Tools

Troubleshooting in gun drilling

Problem		Cause	Countermeasure	
Hole accuracy	Rough surface finish	Machine	Clamping the workpiece is unstable.	Clamp the workpiece firmly.
			The type of coolant is not appropriate.	Use water-insoluble coolant.
			Foreign material is in the coolant.	Thoroughly filtrate the coolant (Use a filter with the filtration accuracy in 10 μ m or less).
			The run-out of the spindle is too large.	Minimize the run-out of the spindle.
			The clearance between the guide bush and the drill is not appropriate.	Replace the guide bush (The clearance should be between +0.003 mm and +0.008 mm).
			The feed speed (V_f) varies.	Use mechanical feed.
			The number of revolutions varies (decreases).	Increase the machine power or adjust the cutting conditions.
		Drill	Abnormal damage occurs.	See "Short tool life" for the details.
			Regrinding is in poor quality.	Make sure no damage is left on the drill and that the cutting edge geometry is not changed.
		Cutting condition	The feed (f) is too high.	Reduce the feed.
	Others	Chip packing occurs.	See "Chip packing" for the details.	
	Unacceptable circularity, cylindricity, and oversize	Machine	The clearance between the guide bush and the drill is not appropriate.	Replace the guide bush (The clearance should be between +0.003 mm and +0.008 mm).
			The guide bush is apart from the workpiece surface at the entry.	Contact the guide bush closely with the workpiece.
			The type of coolant is not appropriate.	Use water-insoluble coolant.
			The concentricity of the guide bush and the spindle is too large.	Decrease the concentricity of the guide bush and the spindle.
		Drill	Abnormal damage occurs.	See "Short tool life" for the details.
			Regrinding is in poor quality.	Make sure no damage is left on the drill and that the cutting edge geometry is not changed.
		Cutting condition	The feed (f) is not suitable.	Use an appropriate feed.
		Workpiece	Interrupted or cross drilling is required.	Change the tool to a standard gundrill.
		Others	Chip packing occurs.	See "Chip packing" for the details.
		Bending of hole	Machine	Clamping the workpiece is unstable.
	The guide bush is apart from the workpiece surface at the entry.			Contact the guide bush closely with the workpiece.
	The concentricity of the guide bush and the spindle is too large.			Decrease the concentricity of the guide bush and the spindle.
	The clearance between the guide bush and the drill is not appropriate.			Replace the guide bush (The clearance should be between +0.003 mm and +0.008 mm).
	Drill		The selection of the guide pads is not suitable.	Use 2 guide pads instead of 3.
			Regrinding is in poor quality.	Make sure no damage is left on the drill and that the cutting edge geometry is not changed.
	Cutting condition		The feed (f) is too high.	Reduce the feed.
	Workpiece		The workpiece has blow holes or unevenness.	Use the workpiece without defect.
The workpiece surface is slanted at the entry.			Use low feed.	
Interrupted or cross drilling is required.			Change the tool to a standard gundrill.	

User's Guide- Technical Reference

Drilling Tools

Troubleshooting in gun drilling

Problem		Cause	Countermeasure	
Short tool life	Abnormal wear	Machine	The type of coolant is not appropriate.	Use water-insoluble coolant.
			Foreign material is in the coolant.	Thoroughly filtrate the coolant (Use a filter with the filtration accuracy in 10µm or less).
			The clearance between the guide bush and the drill is not appropriate.	Replace the guide bush (The clearance should be between +0.003 mm and +0.008 mm).
			Whipping effect occurs.	Place a whip guide at the appropriate position.
			The concentricity of the guide bush and the spindle is too large.	Decrease the concentricity of the guide bush and the spindle.
			The coolant temperature is too high.	Increase the capacity of the tank.
		Drill	The selection of the guide pads is not suitable.	Use 2 guide pads instead of 3.
			Regrinding is in poor quality.	Make sure no damage is left on the drill and that the cutting edge geometry is not changed.
			The drill's overall length is excessive.	Reduce the drill's overall length.
			Excessive wear occurs and the chip shape changes.	Regrind the gundrill (ease the tool life criteria).
		Cutting condition	The cutting speed (Vc) is too high.	Reduce the cutting speed.
			The feed (f) is too high.	Reduce the feed.
			The coolant pressure is not high enough.	Increase the coolant pressure.
		Workpiece	The material quality varies.	Reduce the cutting speed (Vc).
		Chip control	Chip packing	Machine
The number of revolutions varies (decreases).	Increase the machine power or adjust the cutting conditions.			
The chip box is too small for smooth chip evacuation.	Enlarge the chip box.			
Cutting condition	The feed (f) is not suitable.			Use an appropriate feed.
	The coolant pressure is not high enough.			Increase the coolant pressure.
Workpiece	Interrupted or cross drilling is required.			Change the tool to a standard gundrill.
	The operation is for stacked plates.			Change the cutting edge shape so that the cores become small.
	The material quality varies.			Increase the feed.
Chip entanglement	Drill			The cutting edge is fractured or chipped.
			Wear on the outer corner is excessive.	Regrind the gundrill (ease the tool life criteria).
	Cutting condition		The feed (f) is too low.	Increase the feed.
	Workpiece		Drilling a center hole is required.	Make the center hole as small as the drill diameter and increase the coolant pressure.

User's Guide- Technical Reference

Drilling Tools

Nomenclature for gun reamer

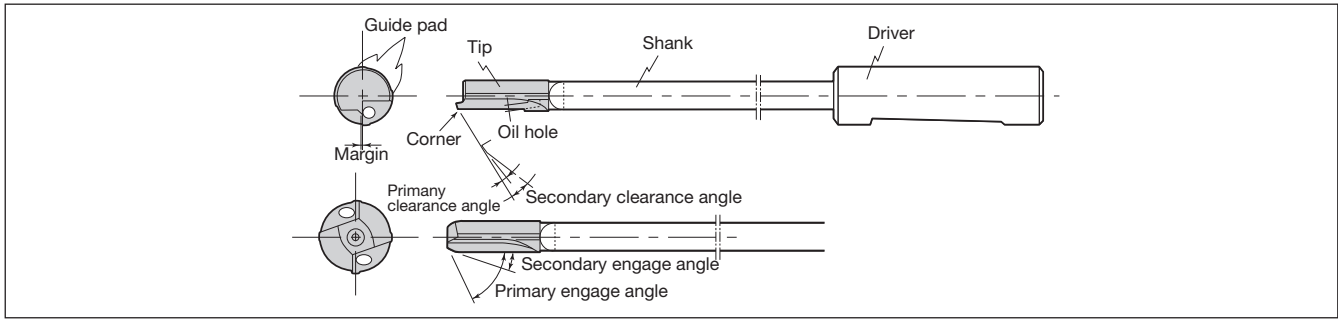

Troubleshooting in gun reaming

Trouble		Possible cause	Countermeasure		
Breaking of reamer	Increased burnishing torque due to excessively small stock allowance	● Chamfer angle small	● Enlarge chamfer angle and increase stock allowance		
		● Excessive wear in peripheral cutting edge.	● Reduce cutting speed to prevent peripheral wear of edge ● Increase lubricity of cutting fluid		
	Sticking	● Faulty filtering of cutting fluid ● Incorrect selection of cutting fluid ● Insufficient cutting fluid pressure	● Improve filtering accuracy ● Change to fluid with higher lubricity ● Increase fluid pressure		
Mechanical trouble			● Repair electrical system ● Improve clamping method of workpiece		
Faulty machining accuracy	Unacceptable surface roughness	Excessive feed rate per tooth	● Reduce fluid pressure ● Increase number of teeth		
		Improper tool specifications	● Excessive chamfer angle ● Excessive back taper ● Peripheral run out excessive	● Reduce chamfer angle ● Reduce back taper ● Improve run out accuracy	
	Too large and inconsistent over size	Faulty regrinding	● Cutting edge run out is large ● Residual damage of preceding process	● Improve run out accuracy ● Remove residual damage completely	
		Improper cutting fluid	● Excessive fluid pressure ● Improper selection of cutting fluid	● Reduce fluid pressure ● Increase activity and lubricity of the fluid	
	Faulty machine accuracy			● Correct spindle run out and bushing clearance and alignment	
	Faulty clamping of workpiece		● Clamping position wrong ● Clamping force inadequate	● Improper clamping position ● Increase clamping force	
	Defective out-of-roundness	Faulty machine accuracy		● Excessive bushing clearance ● Faulty spindle run out and alignment	● Correct bushing clearance ● Correct spindle run out and alignment
		Improper tool specifications		● Outer run out of reamer large ● Insufficient reamer rigidity	● Correct peripheral run out ● Increase reamer rigidity
		Faulty clamping position of workpiece			● Change clamping position
		Unevenness in wall thickness of workpiece			● Reduce reamer guide width (margin width)
Insufficient oversize allowance	Chamfer angle small		● Increase chamfer angle		
	Excessive wear in peripheral cutting edge	● Too high cutting speed ● Faulty lubricity of cutting fluid	● Decrease cutting speed ● Increase lubricating capacity		
		Faulty regrinding (residual damage)		● Increase regrinding stock amount	

User's Guide- Technical Reference

International Tolerance (IT Grade)

International Tolerance (IT Grade)

IT grades shows a tolerance allowable for difference of the diameters of a hole and a shaft. As the number added after IT increases, the tolerance becomes rough. Depending on the basic size, the tolerance value in each grade varies.

In the catalog, IT grades are shown as a guide of dimensional dispersion in the diameters of holes machined with the drill. For information, H8 tolerance for a $\varnothing 8.0$ hole is 0 to + 0.022 mm, the width of the value is the same as that of IT 8.

In the Table shown below, tolerance areas attainable with typical drilling tools are distinguished by using different colors. Solid drills are generally used for machining holes of IT 9 to 12. For machining a hole of better than IT 8, finishing process such as reaming is required. For a hole better than IT 5, high-precision finishing is required. Above description is based on machining of general steel. In practice, the IT grade attained with the tool varies widely depending on the hardness and the composition of the work material.

● IT (International Tolerance) Grades

Basic size (mm)		International tolerance grade																				
		IT1	IT2	IT3	IT4	IT5	IT6	IT7	IT8	IT9	IT10	IT11	IT12	IT13	IT14	IT15	IT16	IT17	IT18			
>	≤						(μm)						(mm)									
-	3	0.8	1.2	2	3	4	6	10	14	25	40	60	0.1	0.14	0.25	0.4	0.6	1	1.4			
3	6	1	1.5	2.5	4	5	8	12	18	30	48	75	0.12	0.18	0.3	0.48	0.75	1.2	1.8			
6	10	1	1.5	2.5	4	6	9	15	22	36	58	90	0.15	0.22	0.36	0.58	0.9	1.5	2.2			
10	18	1.2	2	3	5	8	11	18	27	43	70	110	0.18	0.27	0.43	0.7	1.1	1.8	2.7			
18	30	1.5	2.5	4	6	9	13	21	33	52	84	130	0.21	0.33	0.52	0.84	1.3	2.1	3.3			
30	50	1.5	2.5	4	7	11	16	25	39	62	100	160	0.25	0.39	0.62	1	1.6	2.5	3.9			
50	80	2	3	5	8	13	19	30	46	74	120	190	0.3	0.46	0.74	1.2	1.9	3	4.6			
80	120	2.5	4	6	10	15	22	35	54	87	140	220	0.35	0.54	0.87	1.4	2.2	3.5	5.4			
120	180	3.5	5	8	12	18	25	40	63	100	160	250	0.4	0.63	1	1.6	2.5	4	6.3			
180	250	4.5	7	10	14	20	29	46	72	115	185	290	0.46	0.72	1.15	1.85	2.9	4.6	7.2			
250	315	6	8	12	16	23	32	52	81	130	210	320	0.52	0.81	1.3	2.1	3.2	5.2	8.1			
315	400	7	9	13	18	25	36	57	89	140	230	360	0.57	0.89	1.4	2.3	3.6	5.7	8.9			
400	500	8	10	15	20	27	40	63	97	155	250	400	0.63	0.97	1.55	2.5	4	6.3	9.7			
500	630	9	11	16	22	32	44	70	110	175	280	440	0.7	1.1	1.75	2.8	4.4	7	11			
630	800	10	13	18	25	36	50	80	125	200	320	500	0.8	1.25	2	3.2	5	8	12.5			
800	1000	11	15	21	28	40	56	90	140	230	360	560	0.9	1.4	2.3	3.6	5.6	9	14			
1000	1250	13	18	24	33	47	66	105	165	260	420	660	1.05	1.65	2.6	4.2	6.6	10.5	16.5			
1250	1600	15	21	29	39	55	73	125	195	310	500	780	1.25	1.95	3.1	5	7.8	12.5	19.5			
1600	2000	18	25	35	46	65	92	150	230	370	600	920	1.5	2.3	3.7	6	9.2	15	23			
2000	2500	22	30	41	55	78	110	175	280	440	700	1100	1.75	2.8	4.4	7	11	17.5	28			
2500	3150	26	36	50	68	96	135	210	330	540	860	1350	2.1	3.3	5.4	8.6	13.5	21	33			

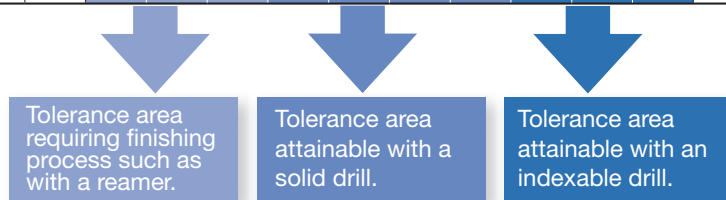

User's Guide- Technical Reference

Deviations of Shafts to be Used in Commonly Used Fits

Deviations of Shafts to be Used in Commonly Used Fits (JIS B0401 extrac)

Basic size step (mm)		Tolerance zone class of shaft (μm)															
>	≤	e9	f6	f7	f8	g5	g6	h5	h6	h7	h8	h9	js5	js6	js7	k5	k6
-	3	-14 -39	-6 -12	-6 -16	-6 -20	-2 -6	-2 -8	0 -4	0 -6	0 -10	0 -14	0 -25	±2	±3	±5	+4 0	+6 0
3	6	-20 -50	-10 -18	-10 -22	-10 -28	-4 -9	-4 -12	0 -5	0 -8	0 -12	0 -18	0 -30	±2.5	±4	±6	+6 +1	+9 +1
6	10	-25 -61	-13 -22	-13 -28	-13 -35	-5 -11	-5 -14	0 -6	0 -9	0 -15	0 -22	0 -36	±3	±4.5	±7	+7 +1	+10 +1
10	14	-32 -75	-16 -27	-16 -34	-16 -43	-6 -14	-6 -17	0 -8	0 -11	0 -18	0 -27	0 -43	±4	±5.5	±9	+9 +1	+12 +1
14	18																
18	24	-40 -92	-20 -33	-20 -41	-20 -53	-7 -16	-7 -20	0 -9	0 -13	0 -21	0 -33	0 -52	±4.5	±6.5	±10	+11 +2	+15 +2
24	30																
30	40	-50 -112	-25 -41	-25 -50	-25 -64	-9 -20	-9 -25	0 -11	0 -16	0 -25	0 -39	0 -62	±5.5	±8	±12	+13 +2	+18 +2
40	50																
50	65	-60 -134	-30 -49	-30 -60	-30 -76	-10 -23	-10 -29	0 -13	0 -19	0 -30	0 -46	0 -74	±6.5	±9.5	±15	+15 +2	+21 +2
65	80																
80	100	-72 -159	-36 -58	-36 -71	-36 -90	-12 -27	-12 -34	0 -15	0 -22	0 -35	0 -54	0 -87	±7.5	±11	±17	+18 +3	+25 +3
100	120																

In every step given in the table, the value on the upper side shows the upper deviation and the value on the lower side, the lower deviation.

Deviations of Holes to be Used in Commonly Used Fits. (JIS B0401 extrac)

Basic size step (mm)		Tolerance zone class of hole (μm)																
>	≤	E7	E8	E9	F6	F7	F8	G6	G7	H6	H7	H8	H9	H10	JS6	JS7	K6	K7
-	3	+24 +14	+28 +14	+39 +14	+12 +6	+16 +6	+20 +6	+8 +2	+12 +2	+6 0	+10 0	+14 0	+25 0	+40 0	±3	±5	0 -6	0 -10
3	6	+32 +20	+38 +20	+50 +20	+18 +10	+22 +10	+28 +10	+12 +4	+16 +4	+8 0	+12 0	+18 0	+30 0	+48 0	±4	±6	+2 -6	+3 -9
6	10	+40 +25	+47 +25	+61 +25	+22 +13	+28 +13	+35 +13	+14 +5	+20 +5	+9 0	+15 0	+22 0	+36 0	+58 0	±4.5	±7	+2 -7	+5 -10
10	14	+50 +32	+59 +32	+75 +32	+27 +16	+34 +16	+43 +16	+17 +6	+24 +6	+11 0	+18 0	+27 0	+43 0	+70 0	±5.5	±9	+2 -9	+6 -12
14	18																	
18	24	+61 +40	+73 +40	+92 +40	+33 +20	+41 +20	+53 +20	+20 +7	+28 +7	+13 0	+21 0	+33 0	+52 0	+84 0	±6.5	±10	+2 -11	+6 -15
24	30																	
30	40	+75 +50	+89 +50	+112 +50	+41 +25	+50 +25	+64 +25	+25 +9	+34 +9	+16 0	+25 0	+39 0	+62 0	+100 0	±8	±12	+3 -13	+7 -18
40	50																	
50	65	+90 +60	+106 +60	+134 +60	+49 +30	+60 +30	+76 +30	+29 +10	+40 +10	+19 0	+30 0	+46 0	+74 0	+120 0	±9.5	±15	+4 -15	+9 -21
65	80																	
80	100	+107 +72	+126 +72	+159 +72	+58 +36	+71 +36	+90 +36	+34 +12	+47 +12	+22 0	+35 0	+54 0	+87 0	+140 0	±11	±17	+4 -18	+10 -25
100	120																	

In every step given in the table, the value on the upper side shows the upper deviation and the value on the lower side, the lower deviation.

User's Guide- Technical Reference

Symbols of Metals

● Carbon steel and alloy steel for structural use

Type	Japan	International	Other countries				
	JIS		ISO	U.S.A. AISI SAE	Great Britain BS BS/EN	Germany DIN DIN/EN	France NF NF/EN
Carbon steel	S10C	C10	1010	C10 C10E C10R	C10E C10R	C10E C10R	-
	S15C	C15E4 C15M2	1015	C15 C15E C15R	C15E C15R	C15E C15R	-
	S20C	-	1020	C22, C22E C22R	C22 C22E C22R	C22 C22E C22R	-
	S25C	C25 C25E4 C25M2	1025	C25 C25E C25R	C25 C25E C25R	C25 C25E C25R	-
	S30C	C30 C30E4 C30M2	1030	C30 C30E C30R	C30 C30E C30R	C30 C30E C30R	30Г
	S35C	C35 C35E4 C35M2	1035	C35 C35E C35R	C35 C35E C35R	C35 C35E C35R	35Г
	S40C	C40 C40E4 C40M2	1039 1040	C40 C40E C40R	C40 C40E C40R	C40 C40E C40R	40Г
	S43C	-	1042 1043	080A42	-	-	40Г
	S45C	C45 C45E4 C45M2	1045 1046	C45 C45E C45R	C45 C45E C45R	C45 C45E C45R	45Г
	S48C	-	-	-	-	-	45Г
	S50C	C50 C50E4 C50M2	1049	C50 C50E C50R	C50 C50E C50R	C50 C50E C50R	50Г
	S53C	-	1050 1053	-	-	-	50Г
	S55C	C55 C55E4 C55M2	1055	C55 C55E C55R	C55 C55E C55R	C55 C55E C55R	-
	S58C	C60 C60E4 C60M2	1059 1060	C60 C60E C60R	C60 C60E C60R	C60 C60E C60R	60Г

Type	Japan	International	Other countries				
	JIS		ISO	U.S.A. AISI SAE	Great Britain BS BS/EN	Germany DIN DIN/EN	France NF NF/EN
Nickel chromium steel	SNC236	-	-	-	-	-	40XH
	SNC415(H)	-	-	-	-	-	-
	SNC631(H)	-	-	-	-	-	30XH3A
	SNC815(H)	15NiCr13	-	15NiCr13	15NiCr13	15NiCr13	-
	SNC836	-	-	-	-	-	-
Alloy steel Nickel chromium molybdenum steel	SNCM220	20NiCrMo2 20NiCrMoS2	8615 8617(H) 8620(H) 8622(H)	20NiCrMo2-2 20NiCrMoS2-2	20NiCrMo2-2 20NiCrMoS2-2	20NiCrMo2-2 20NiCrMoS2-2	-
	SNCM240	41CrNiMo2 41CrNiMoS2	8637 8640	-	-	-	-
	SNCM415	-	-	-	-	-	-
	SNCM420(H)	-	4320(H)	-	-	-	20XH2M(20XHM)
	SNCM431	-	-	-	-	-	-
	SNCM439	-	4340	-	-	-	-
	SNCM447	-	-	-	-	-	-
	SNCM616	-	-	-	-	-	-
	SNCM625	-	-	-	-	-	-
	SNCM630	-	-	-	-	-	-
SNCM815	-	-	-	-	-	-	

Note: The above chart is based on published data and not authorized by each manufacturer.

User's Guide- Technical Reference

Symbols of Metals

● Alloy steel

Type	Japan	International ISO	Other countries				
	JIS		U.S.A. AISI SAE	Great Britain BS BS/EN	Germany DIN DIN/EN	France NF NF/EN	Russia ГОСТ
Chromium steel	SCr415(H)	–	–	17Cr3 17CrS3	17Cr3 17CrS3	17Cr3 17CrS3	15X 15XA
	SCr420(H)	20Cr4(H) 20CrS4	5120(H)	–	–	–	20X
	SCr430(H)	34Cr4 34CrS4	5130(H) 5132(H)	34Cr4 34CrS4	34Cr4 34CrS4	34Cr4 34CrS4	30X
	SCr435(H)	34Cr4 34CrS4 37Cr4 37CrS4	5132	37Cr4 37CrS4	37Cr4 37CrS4	37Cr4 37CrS4	35X
	SCr440(H)	37Cr4 37CrS4 41Cr4 41CrS4	5140(H)	530M40 41Cr4 41CrS4	41Cr4 41CrS4	41Cr4 41CrS4	40X
	SCr445(H)	–	–	–	–	–	45X
Chromium molybdenum steel	SCM415(H)	–	–	–	–	–	–
	SCM418(H)	18CrMo4 18CrMoS4	–	18CrMo4 18CrMoS4	18CrMo4 18CrMoS4	18CrMo4 18CrMoS4	20XM
	SCM420(H)	–	–	708M20(708H20)	–	–	20XM
	SCM430	–	4130	–	–	–	30XM 30XMA
	SCM432	–	–	–	–	–	–
	SCM435(H)	34CrMo4 34CrMoS4	4137(H)	34CrMo4 34CrMoS4	34CrMo4 34CrMoS4	34CrMo4 34CrMoS4	35XM
	SCM440(H)	42CrMo4 42CrMoS4	4140(H) 4142(H)	42CrMo4 42CrMoS4	42CrMo4 42CrMoS4	42CrMo4 42CrMoS4	–
SCM445(H)	–	4145(H) 4147(H)	–	–	–	–	
Manganese steel and manganese chromium steel	SMn420(H)	22Mn6(H)	1522(H)	–	–	–	–
	SMn433(H)	–	1534	–	–	–	30Г2 35Г2
	SMn438(H)	36Mn6(H)	1541(H)	–	–	–	35Г2 40Г2
	SMn443(H)	42Mn6(H)	1541(H)	–	–	–	40Г2 45Г2
	SMnC420(H) SMnC443(H)	– –	– –	– –	– –	– –	– –
Aluminum chromium molybdenum steel	SACM645	41CrAlMo74	–	–	–	–	–

● Stainless steel

Type	Japan	International ISO	Other countries						
	JIS		U.S.A. UNS	AISI SAE	Great Britain BS BS/EN	Germany DIN DIN/EN	France NF NF/EN	Russia ГОСТ	
Austenitic	SUS201	X12CrMnNiN17-7-5	S20100	201	–	–	–	Z12CMN17-07Az	–
	SUS202	X12CrMnNiN18-9-5	S20200	202	284S16	–	–	–	12X17I9AH4
	SUS301	X10CrNi18-8	S30100	301	301S21	–	X12CrNi17-7	Z11CN17-08	07X16H6
	SUS301L	X2CrNiN18-7	–	–	–	–	X2CrNiN18-7	–	–
	SUS301J1	–	–	–	–	–	X12CrNi17-7	–	–
	SUS302	–	S30200	302	302S25	–	–	Z12CN18-09	12X18H9
	SUS302B	X12CrNiSi18-9-3	S30215	302B	–	–	–	–	–
	SUS303	X10CrNiS18-9	S30300	303	303S21	–	X10CrNiS18-9	Z8CNF18-09	–
	SUS303Se	–	S30323	303Se	303S41	–	–	–	12X18H10E
	SUS303Cu	–	–	–	–	–	–	–	–
	SUS304	X5CrNi18-9	S30400	304	304S31	–	X5CrNi18-10	Z7CN18-09	08X18H10
	SUS304L	X2CrNi18-9	S30403	304L	304S11	–	X2CrNi19-11	Z3CN19-11	03X18H11
	SUS304N1	X5CrNiN18-8	S30451	304N	–	–	–	Z6CN19-09Az	–
	SUS304N2	–	S30452	–	–	–	–	–	–
	SUS304LN	X2CrNiN18-9	S30453	304LN	–	–	X2CrNiN18-10	Z3CN18-10Az	–
	SUS304J1	–	–	–	–	–	–	–	–
	SUS304J2	–	–	–	–	–	–	–	–
	SUS304J3	–	–	S30431	S30431	–	–	–	–
SUS305	X6CrNi18-12	S30500	305	305S19	–	X5CrNi18-12	Z8CN18-12	06X18H11	

Note: The above chart is based on published data and not authorized by each manufacturer.

User's Guide- Technical Reference

Symbols of Metals

- Stainless steel

Type	Japan	International	Other countries						
	JIS		ISO	U.S.A.		Great Britain	Germany	France	Russia
		UNS		AISI SAE	BS BS/EN	DIN DIN/EN	NF NF/EN	ГОСТ	
Stainless steel	Austenitic	SUS305J1							
		SUS309S		S30908	309S			Z10CN24-13	
		SUS310S	X6CrNi25-21	S31008	310S	310S31		Z8CN25-20	10X23H18
		SUS315J1							
		SUS315J2							
		SUS316	X5CrNiMo17-12-2 X3CrNiMo17-12-3	S31600	316	316S31	X5CrNiMo17-12-2 X5CrNiMo17-13-3	Z7CND17-12-02 Z6CND18-12-03	
		SUS316F							
		SUS316L	X2CrNiMo17-12-2 X2CrNiMo17-12-3 X2CrNiMo18-14-3	S31603	316L	316S11	X2CrNiMo17-13-2 X2CrNiMo17-14-3	Z3CND17-12-02 Z3CND17-12-03	03X17H14M3
		SUS316N		S31651	316N				
		SUS316LN	X2CrNiMoN17-11-2 X2CrNiMoN17-12-3	S31653	316LN		X2CrNiMoN17-12-2 X2CrNiMoN17-13-3	Z3CND17-11Az Z3CND17-12Az	
		SUS316Ti	X6CrNiMoTi17-12-2	S31635			X6CrNiMoTi17-12-2	Z6CNDT17-12	08X17H13M2T
		SUS316J1							
		SUS316J1L							
		SUS317		S31700	317	317S16			
		SUS317L	X2CrNiMo19-14-4	S31703	317L	317S12	X2CrNiMo18-16-4	Z3CND19-15-04	
		SUS317LN	X2CrNiMoN18-12-4	S31753				Z3CND19-14Az	
		SUS317J1							
		SUS317J2							
		SUS317J3L							
		SUS836L		N08367					
		SUS890L	X1CrNiMoCu25-20-5	N08904	N08904	904S14		Z2NCU25-20	
		SUS321	X6CrNiTi18-10	S32100	321	321S31	X6CrNiTi18-10	Z6CNT18-10	08X18H10T
		SUS347	X6CrNiNb18-10	S34700	347	347S31	X6CrNiNb18-10	Z6CNCNb18-10	08X18H12B
		SUS384	X3NiCr18-16	S38400	384			Z6CN18-16	
		SUSXM7	X3CrNiCu18-9-4	S30430	304Cu	394S17		Z2CNU18-10	
	SUSXM15J1		S38100				Z15CNS20-12		
	Austenitic Ferritic	SUS329J1		S32900	329				
		SUS329J3L	X2CrNiMoN22-5-3	S31803	31803		Z3CNDU22-05Az	08X21H6M2T	
		SUS329J4L	X2CrNiMoCuN25-6-3	S32250	32250		Z3CNDU25-07Az		
	Ferritic	SUS405	X6CrAl13	S40500	405	405S17	X6CrAl13	Z8CA12	
		SUS410L					Z3C14		
		SUS429		S42900	429				
		SUS430	X6Cr17	S43000	430	430S17	X6Cr17	Z8C17	12X17
		SUS430F	X7CrS17	S43020	430F		X7CrS18	Z8CF17	
		SUS430LX	X3CrTi17	S43035			X6CrTi17	Z4CT17	
			X3CrNb17						
		SUS430J1L	X2CrTi17				X6CrNb17	Z4CNb17	
		SUS434	X6CrMo17-1	S43400	434	434S17	X6CrMo17-1	Z8CD17-01	
		SUS436L	X1CrMoTi16-1	S43600	436				
		SUS436J1L							
		SUS444	X2CrMoTi18-2	S44400	444			Z3CDT18-02	
		SUS445J1							
		SUS445J2							
		SUS447J1		S44700					
	SUSXM27		S44627				Z1CD26-01		
Martensitic	SUS403		S40300	403					
	SUS410	X12Cr13	S41000	410	410S21	X10Cr13	Z13C13		
	SUS410S	X6Cr13	S41008	410S	403S17	X6Cr13	Z8C12	08X13	
	SUS410F2								
	SUS410J1		S41025						
	SUS416	X12CrS13	S41600	416	416S21		Z11CF13		
	SUS420J1	X20Cr13	S42000	420	420S29	X20Cr13	Z20C13	20X13	
	SUS420J2	X30Cr13	S42000	420	420S37	X30Cr13	Z33C13	30X13	
	SUS420F	X29CrS13	S42020	420F			Z30CF13		
	SUS420F2								
	SUS429J1								
	SUS431	X19CrNi16-2	S43100	431	431S29	X20CrNi17-2	Z15CN16-02	20X17H2	
	SUS440A	X70CrMo15	S44002	440A			Z70C15		
	SUS440B		S44003	440B					
	SUS440C	X105CrMo17	S44004	440C			Z100CD17	95X18	
SUS440F		S44020	S44020						
Precipitation hardening type	SUS630	X5CrNiCuNb16-4	S17400	S17400			Z6CNU17-04		
	SUS631	X7CrNiAl17-7	S17700	S17700		X7CrNiAl17-7	Z9CNA17-07	09X17H7I0	
	SUS631J1								

Note: The above chart is based on published data and not authorized by each manufacturer.

User's Guide- Technical Reference

Symbols of Metals

● Heat resistant steel

Type	Japan	International	Other countries					
	JIS		ISO	U.S.A.		Great Britain	Germany	France
		UNS		AISI SAE	BS BS/EN	DIN DIN/EN	NF NF/EN	ГОСТ
Austenitic	SUH31				331S42		Z35CNWS14-14	45X14H14B2M
	SUH35		S63008		349S52		Z52CMN21-09Az	
	SUH36				349S54	X53CrMnNi21-9	Z55CMN21-09Az	55X20Г9 AH4
	SUH37		S63017		381S34			
	SUH38							
	SUH309		S30900	309	309S24		Z15CN24-13	
	SUH310		S31000	310	310S24	CrNi2520	Z15CN25-20	20X25H20C2
	SUH330		N08330	N08330			Z12NCS35-16	
	SUH660		S66286				Z6NCTV25-20	
	SUH661		R30155					
Ferritic	SUH21					CrAl1205		
	SUH409	X6CrTi12	S40900	409	409S19	X6CrTi12	Z6CT12	
	SUH409L	X2CrTi12					Z3CT12	
	SUH446		S44600	446			Z12C25	15X28
Martensitic	SUH1		S65007		401S45	X45CrSi9-3	Z45CS9	
	SUH3						Z40CSD10	40X10C2M
	SUH4				443S65		Z80CSN20-02	
	SUH11							40X9C2
	SUH600							20X12BHMБФP
	SUH616		S42200					

● Tool steel

Type	Japan	International	U.S.A.	Type	Japan	International	U.S.A.
	JIS		AISI ASTM		JIS		AISI ASTM
Carbon tool steel	SK140	-	-	Alloy tool steel	SKS5	-	-
	SK120	C120U	W1-11 1/2		SKS51	-	L6
	SK105	C105U	W1-10		SKS7	-	-
	SK95	-	W1-9		SKS81	-	-
	SK90	C90U	-		SKS8	-	-
	SK85	-	W1-8		SKS4	-	-
	SK80	C80U	-		SKS41	-	-
	SK75	-	-		SKS43	105V	W2-9 1/2
	SK70	C70U	-		SKS44	-	W2-8 1/2
	SK65	-	-		SKS3	-	-
	SK60	-	-		SKS31	-	-
	High speed steel	SKH2	HS18-0-1		T1	SKS93	-
SKH3		-	T4	SKS94	-	-	
SKH4		-	T5	SKS95	-	-	
SKH10		-	T15	SKD1	X210Cr12	D3	
SKH40		HS6-5-3-8	-	SKD2	X210CrW12	-	
SKH50		HS1-8-1	-	SKD10	X153CrMoV12	-	
SKH51		HS6-5-2	M2	SKD11	-	D2	
SKH52		HS6-6-2	M3-1	SKD12	X100CrMoV5	A2	
SKH53		HS6-5-3	M3-2	SKD4	-	-	
SKH54		HS6-5-4	M4	SKD5	X30WCrV9-3	H21	
SKH55		HS6-5-2-5	-	SKD6	-	H11	
SKH56		-	M36	SKD61	X40CrMoV5-1	H13	
SKH57	HS10-4-3-10	-	SKD62	X35CrWMoV5	H12		
SKH58	HS2-9-2	M7	SKD7	32CrMoV12-28	H10		
SKH59	HS2-9-1-8	M42	SKD8	38CrCoWV18-17-17	H19		
Alloy tool steel	SKS11	-	F2	SKT3	-	-	
	SKS2	-	-	SKT4	55NiCrMoV7	-	
	SKS21	-	-	SKT6	45NiCrMo16	-	

● Special use steel

Type	Japan	International	U.S.A.	Type	Japan	International	U.S.A.
	JIS		AISI ASTM		JIS		AISI ASTM
Free cutting carbon steels	SUM11	-	1110	Free cutting carbon steels	SUM32	-	-
	SUM12	-	1109		SUM41	-	1137
	SUM21	9S20	1212		SUM42	-	1141
	SUM22	11SMn28	1213		SUM43	44SMn28	1144
	SUM22L	11SMnPb28	-	High carbon chromium	SUJ1	-	-
	SUM23	-	1215		SUJ2	B1	52100
	SUM23L	-	-		SUJ3	B2	ASTM A 485 Grade 1
	SUM24L	11SMnPb28	12L14		SUJ4	-	-
	SUM25	12SMn35	-		SUJ5	-	-
	SUM31	-	1117				
SUM31L	-	-					

Note: The above chart is based on published data and not authorized by each manufacturer.

User's Guide- Technical Reference

Symbols of Metals

● Casting or forging steel

Type	Japan	International	Other countries					
	JIS	ISO	U.S.A. AISI ASTM	Great Britain BS BS/EN	Germany DIN DIN/EN	France NF NF/EN	Russia ГОСТ	
Casting steel	Carbon steel casting	SC	200-400, 230-450, 270-480	U-	A1, A2	GS-	GE230, GE280, GE320	-
	Steel casting for welded structure	SCW	200-400W, 230-450W, 270-480W, 340-550W	WCA, WCB, WCC	A4	-	GE230, GE280	-
	Heat resisting steel casting	SCH	GX40CrSi24, GX40CrNiSi22-10, GX40NiCrSi38-19	Grade HC, HD, HF	309C30, 310C45, 330C12	-	GX40NiCrNb45-35, GX50NiCrCoW35-25-15-5	-
	Steel casting for high temperature and high pressure service	SCPH	-	Grade WC1, WC6, WC9	A1, A2, B1, B2, B3, B4, B5, B7	G20Mo5, G17CrMo5-5, G17CrMo5-10	G17CrMo9-10, GX15CrMo5, GP240GH, GP280GH	-
	Steel casting for low temperature and high pressure service	SCPL	-	Grade LCB, LC1, LC2, LC3	AL1, BL2	-	FB-M, FC1-M, FC2-M, FC3-M	-
Casting iron	Grey iron casting	FC	100,150,200,250, 300,350	No.20,25,30,35, 40,45,50	EN-GJL-	EN-GJL-	EN-GJL-	-
	Spheroidal graphite iron casting	FCD	700-2, 600-3, 500-7, 450-10, 400-15, 400-18, 350-22	60-40-18, 65-45-12, 8-55-06, 100-70-03, 120-90-02	EN-GJS-	EN-GJS-	EN-GJS-	B4
	Austempered spheroidal graphite iron casting	FCAD	-	-	EN-GJS-	EN-GJS-	EN-GJS-	-
	Austenitic iron casting	FCA-FCDA-	L-, S-	Type 1, 2, Type D-2, D-3A Class 1, 2	F1, F2, S2W, S5S	GGL-, GGG-	L-, S-	-
Forging steel	Carbon steel forging for general use	SF	-	Class A, B, C, D, E, F	C22, C25, C30, C35, C40, C45, C50, C55, C60	P285, P355	P245, P280, P305	-
	Chromium molybdenum steel forgings for general use	SFCM	-	Class E, F, G, I Grade 3A, 4 Class G, J, K, L, M	-	-	-	-
	Nickel Chromium molybdenum steel forgings for general use	SFNCM	-	Class G, H, I, J Class 3A, 4, 5, 6 Class K, L, M	-	-	-	-

● Non-ferrous alloy

Type	Japan	International	Other countries			
	JIS	ISO	U.S.A. ASTM SAE	Great Britain BS BS/EN	Germany DIN DIN/EN	
Copper alloy, Nickel alloy	Copper alloy casting	CAC101	-	-	-	
		CAC102	-	-	-	
		CAC103	-	-	-	
	Brass casting	CAC201	-	-	-	-
		CAC202	-	C85400	-	-
		CAC203	-	C85700	-	-
	High strength brass casting	CAC301	-	C86500	-	-
		CAC302	-	C86400	-	-
		CAC303	-	C86200	-	-
		CAC304	-	C86300	-	-
	Bronze casting	CAC401	-	C84400	-	-
		CAC402	-	C90300	-	-
		CAC403	-	C90500	-	-
		CAC406	-	C83600	-	-
	Phosphor bronze casting	CAC407	-	C92200	-	-
		CAC502A	-	-	-	-
		CAC502B	-	C90700	-	-
		CAC503A	-	C90800	-	-
	Aluminum bronze casting	CAC503B	-	-	-	-
		CAC701	-	C95200	-	-
		CAC702	-	C95400	-	-
		CAC703	-	C95410	-	-
	Silicon bronze castings	CAC704	-	C95800	-	-
		CAC801	-	C95700	-	-
		CAC802	-	-	-	-
	CAC803	-	C87500	-	-	
	CAC804	-	C87400	-	-	
					CuSn10-C(CC480K) CuSn12-C(CC483K)	
					CuAl10Fe2-C(CC331G) CuAl10Ni3Fe2-C(CC332G) CuAl10Fe5Ni5-C(CC333G)	
					CuZn15As-C(CC760S) CuZn33Pb2-C(CC750S) CuZn39Pb1-C(CC754S) CuZn35Mn2Al1Fe-C(CC765S) CuZn34Mn3Al2Fe1-C(CC764S) CuZn25Al5Mn4Fe3-C(CC762S) CuZn25Al5Mn4Fe3-C(CC762S) CuSn3Zn8Pb5-C(CC490K) CuSn5Zn5Pb5-C(CC490K)	
					CuZn16Si4-C(CC761S)	

Note: The above chart is based on published data and not authorized by each manufacturer.

User's Guide- Technical Reference

Symbols of Metals

● Non-ferrous alloy

Type	Japan	International	Other countries				
	JIS	ISO	U.S.A. ASTM SAE	Great Britain BS BS/EN	Germany DIN DIN/EN	France NF NF/EN	
Aluminum alloy	Aluminum alloy ingots for casting	AC1B	Al-Cu4MgTi	204.0		EN AC-2100	
		AC2A	-	-		-	
		AC2B	-	319.0			
		AC3A	-	-			EN AC-44100
		AC4A	-	-			-
		AC4B	Al-Si8Cu3	333.0			EN AC-46200
		AC4C	Al-Si7Mg(Fe)	356.0			EN AC-42000
		AC4CH	Al-Si7Mg0.3	A356.0			EN AC-42100
		AC4D	-	355.0			EN AC-45300
		AC5A	Al-Cu4Ni2Mg2	242.0			-
		AC7A	-	514.0			-
		AC8A	Al-Si12CuNiMg	-			EN AC-48000
		AC8B	-	-			-
		AC8C	-	332.0			-
	AC9A	-	-			-	
	AC9B	-	-			-	
	Aluminum alloy die casting	ADC1	-	A413.0			-
		ADC3	-	A360.0			-
		ADC5	-	518.0			-
		ADC6	-	-			-
ADC10		-	-			-	
ADC10Z		-	A380.0			-	
ADC12		-	-			-	
ADC12Z		-	383.0			-	
Magnesium alloy	Magnesium alloy casting	MC5	-	AM100A		-	
		MC6	-	ZK51A		-	
		MC7	-	ZK61A		-	
		MC8	MgRE3Zn2Zr	EZ33A		EN MC65120	
		MC9	MgAg3RE2Zr	QE22A		EN MC65210	
		MC10	MgZn4RE1Zr	ZE41A		EN MC35110	
	Magnesium alloy die casting	MD1A	-	AZ91A		G-AZ91Y4	
		MDC1B	-	AZ91B		-	
		MDC1D	MgAl9Zn1(A)	AZ91D		EN MC21120	
		MDC2B	MgAl6Mn	AM60B		EN MC21320	
Type	Japan	International	Other countries				
	JIS	ISO	U.S.A. ASTM AA	Great Britain BS BS/EN	Germany DIN DIN/EN	France NF NF/EN	
Aluminum alloy	Aluminum alloy extruded shapes	A5052S	-	5052		EN AW-5052	
		A5454S	-	5454		EN AW-5454	
		A5083S	AlMg4.5Mn0.7	5083		EN AW-5083	
		A5086S	-	5086		EN AW-5086	
		A6061S	AlMg1SiCu	6061		EN AW-6061	
		A6063S	AlMg0.7Si	6063		EN AW-6063	
		A7003S	-	-			EN AW-7003
		A7N01S	-	-			-
		A7075S	AlZn5.5MgCu	7075			EN AW-7075

Note: The above chart is based on published data and not authorized by each manufacturer.

User's Guide- Technical Reference

Approximate Conversion Table of Hardness

● Approximate conversion value for Brinell hardness. *1

(The source: JIS HB Ferrous Materials and Metallurgy I -2005)

HB		HV	Rockwell *3				HS	Approx. tensile strength (MPa) *2	HB		HV	Rockwell *3				HS	Approx. tensile strength (MPa) *2
Brinell, 10mm ball, Load 3000kg		Vickers	HRA	HRB	HRC	HRD	Shore		Brinell, 10mm ball, Load 3000kg		Vickers	HRA	HRB	HRC	HRD	Shore	
Standard ball	Tungsten carbide ball		A Scale, Load 60kg, Brale Diamond	B Scale, Load 100kg, Diameter 1/16 in. Steel ball	C Scale, Load 150kg, Brale diamond	D Scale, Load 100kg, Brale Diamond			Standard ball	Tungsten carbide ball		A Scale, Load 60kg, Brale Diamond	B Scale, Load 100kg, Diameter 1/16 in. Steel ball	C Scale, Load 150kg, brale diamond	D Scale, Load 100kg, Brale Diamond		
-	-	940	85.6	-	68.0	76.9	97	-	429	429	455	73.4	-	45.7	59.7	61	1510
-	-	920	85.3	-	67.5	76.5	96	-	415	415	440	72.8	-	44.5	58.8	59	1460
-	-	900	85.0	-	67.0	76.1	95	-	401	401	425	72.0	-	43.1	57.8	58	1390
-	(767)	880	84.7	-	66.4	75.7	93	-	388	388	410	71.4	-	41.8	56.8	56	1330
-	(757)	860	84.4	-	65.9	75.3	92	-	375	375	396	70.6	-	40.4	55.7	54	1270
-	(745)	840	84.1	-	65.3	74.8	91	-	363	363	383	70.0	-	39.1	54.6	52	1220
-	(733)	820	83.8	-	64.7	74.3	90	-	352	352	372	69.3	(110.0)	37.9	53.8	51	1180
-	(722)	800	83.4	-	64.0	73.8	88	-	341	341	360	68.7	(109.0)	36.6	52.8	50	1130
-	(712)	-	-	-	-	-	-	-	331	331	350	68.1	(108.5)	35.5	51.9	48	1095
-	(710)	780	83.0	-	63.3	73.3	87	-	321	321	339	67.5	(108.0)	34.3	51.0	47	1060
-	(698)	760	82.6	-	62.5	72.6	86	-	-	-	-	-	-	-	-	-	-
-	(684)	740	82.2	-	61.8	72.1	-	-	311	311	328	66.9	(107.5)	33.1	50.0	46	1025
-	(682)	737	82.2	-	61.7	72.0	84	-	302	302	319	66.3	(107.0)	32.1	49.3	45	1005
-	(670)	720	81.8	-	61.0	71.5	83	-	293	293	309	65.7	(106.0)	30.9	48.3	43	970
-	(656)	700	81.3	-	60.1	70.8	-	-	285	285	301	65.3	(105.5)	29.9	47.6	-	950
-	(653)	697	81.2	-	60.0	70.7	81	-	277	277	292	64.6	(104.5)	28.8	46.7	41	925
-	(647)	690	81.1	-	59.7	70.5	-	-	269	269	284	64.1	(104.0)	27.6	45.9	40	895
-	(638)	680	80.8	-	59.2	70.1	80	-	262	262	276	63.6	(103.0)	26.6	45.0	39	875
-	630	670	80.6	-	58.8	69.8	-	-	255	255	269	63.0	(102.0)	25.4	44.2	38	850
-	627	667	80.5	-	58.7	69.7	79	-	248	248	261	62.5	(101.0)	24.2	43.2	37	825
-	-	677	80.7	-	59.1	70.0	-	-	241	241	253	61.8	100.0	22.8	42.0	36	800
-	601	640	79.8	-	57.3	68.7	77	-	235	235	247	61.4	99.0	21.7	41.4	35	785
-	-	640	79.8	-	57.3	68.7	-	-	229	229	241	60.8	98.2	20.5	40.5	34	765
-	-	640	79.8	-	57.3	68.7	-	-	223	223	234	-	97.3	(18.8)	-	-	-
-	578	615	79.1	-	56.0	67.7	75	-	217	217	228	-	96.4	(17.5)	-	33	725
-	-	607	78.8	-	55.6	67.4	-	-	212	212	222	-	95.5	(16.0)	-	-	705
-	555	591	78.4	-	54.7	66.7	73	2055	207	207	218	-	94.6	(15.2)	-	32	690
-	-	579	78.0	-	54.0	66.1	-	2015	201	201	212	-	93.8	(13.8)	-	31	675
-	534	569	77.8	-	53.5	65.8	71	1985	197	197	207	-	92.8	(12.7)	-	30	655
-	-	553	77.1	-	52.5	65.0	-	1915	192	192	202	-	91.9	(11.5)	-	29	640
-	514	547	76.9	-	52.1	64.7	70	1890	187	187	196	-	90.7	(10.0)	-	-	620
(495)	-	539	76.7	-	51.6	64.3	-	1855	183	183	192	-	90.0	(9.0)	-	28	615
-	-	530	76.4	-	51.1	63.9	-	1825	179	179	188	-	89.0	(8.0)	-	27	600
-	495	528	76.3	-	51.0	63.8	68	1820	174	174	182	-	87.8	(6.4)	-	-	585
(477)	-	516	75.9	-	50.3	63.2	-	1780	170	170	178	-	86.8	(5.4)	-	26	570
-	-	508	75.6	-	49.6	62.7	-	1740	167	167	175	-	86.0	(4.4)	-	-	560
-	477	508	75.6	-	49.6	62.7	66	1740	163	163	171	-	85.0	(3.3)	-	25	545
(461)	-	495	75.1	-	48.8	61.9	-	1680	156	156	163	-	82.9	(0.9)	-	-	525
-	-	491	74.9	-	48.5	61.7	-	1670	149	149	156	-	80.8	-	-	23	505
-	461	491	74.9	-	48.5	61.7	65	1670	143	143	150	-	78.7	-	-	22	490
444	-	474	74.3	-	47.2	61.0	-	1595	137	137	143	-	76.4	-	-	21	460
-	-	472	74.2	-	47.1	60.8	-	1585	131	131	137	-	74.0	-	-	-	450
-	444	472	74.2	-	47.1	60.8	63	1585	126	126	132	-	72.0	-	-	20	435
-	-	472	74.2	-	47.1	60.8	-	1585	121	121	127	-	69.8	-	-	19	415
-	-	472	74.2	-	47.1	60.8	-	1585	116	116	122	-	67.6	-	-	18	400
-	-	472	74.2	-	47.1	60.8	-	1585	111	111	117	-	65.7	-	-	15	385

Note :

*1: This table is based on AMS Metals Handbook, the 8th Edition, Volume 1, and includes some information added to "Approx. tensile strength (MPa)," such as the values calculated in metric; and Brinell hardness that exceeds recommended values.

*2: 1 MPa = 1 N/mm²

*3: Figures in () are not commonly used. It's just reference.

User's Guide- Technical Reference

Surface Roughness

(According to JIS B 0601, 2001 and its explanation.)

Type	Symbol	How to determine	Example (Fig.)
Arithmetic mean roughness	Ra	<p>Ra means the value obtained by the following formula and expressed in micrometer (μm) when sampling only the reference length from the roughness curve in the direction of mean line, taking X-axis in the direction of mean line and Y-axis in the direction of longitudinal magnification of this sampled part and the roughness curve is expressed by y- f (x):</p> $Ra = \frac{1}{\ell} \int_0^{\ell} f(x) dx$ <p>where, ℓ : reference length</p>	
Maximum height	Rz	<p>Rz shall be that only the reference length is sampled from the roughness curve in the direction of mean line, the distance between the top of profile peak line and the bottom of profile valley line on this sampled portion is measured in the longitudinal magnification direction of roughness curve and the obtained value is expressed in micrometer (μm).</p> $Rz = Rp + Rv$	
Ten point mean roughness	RzJIS	<p>RzJIS shall be that only the reference length is sampled from the roughness curve in the direction of its mean line, the sum of the average value of absolute values of the heights of five highest profile peaks (Zp) and the depths of five deepest profile valleys (Zv) measured in the vertical magnification direction from the mean line of this sampled portion and this sum is expressed in micrometer (μm)</p> $RzJIS = \frac{ Zp1 + Zp2 + Zp3 + Zp4 + Zp5 + Zv1 + Zv2 + Zv3 + Zv4 + Zv5 }{5}$	<p>where, Zp1, Zp2, Zp3, Zp4, Zp5 : altitudes of the heights of five highest profile peaks of the sampled portion corresponding to the reference length ℓ</p> <p>where, Zv1, Zv2, Zv3, Zv4, Zv5 : altitudes of the depths of five deepest profile valleys of the sampled portion corresponding to the reference length ℓ</p>

User's Guide- Technical Reference

Grade Comparison Chart

●CVD Coated Grades for Turning

ISO		Tungaloy	Mitsubishi Carbide	Sumitomo Electric	Sandvik	Kyocera	Mitsubishi Hitachi Tool	Dijet	NTK	Seco Tools	Kennametal	Iscar	TaeguTec	Widia	Walter	Ceratizit
Classification	Symbol															
P	P01	T9105	UE6105	AC810P	GC4205 GC4305	CA5505 CA510	HG8010	JC110V		TP0500 TP0501	KC9105 KCP05	IC8150 IC9150 IC9015	TT8115	TN10P TN20K	WPP01 WPP05 WPP05S	
	P10	T9105 T9115	UE6105 UE6110	AC810P AC820P	GC4205 GC4215 GC4305 GC4315	CA5515 CA515	HG8010 GM8020	JC110V JC215V	CP7 CP5	TP0500 TP1500 TP0501 TP1501	KC9110 KC9105 KCP10	IC8150 IC9150 IC8080 IC9080 IC9015	TT8115	TN10P TN20K WP15CT	WPP05 WPP10 WAK20 WPP05S WPP10S	CTC3110 CTCK120
	P20	T9115 T9125	UE6110 UE6020 MC6025	AC820P AC830P AC8025P	GC4215 GC4315 GC4225 GC4325	CA5515 CA515 CA5525 CA525	HG8025 GM8020 GM25	JC110V JC215V	CP7 CP5	TP1500 TP2500 TP1501 TP2501	KC9215 KC9225 KC9325 KCP25	IC8150 IC9150 IC9015 IC8250 IC9250	TT8125 TT5100	TN10P TN15M WP25CT	WPP20 WPP20S	CTCP115 CTCP125 CTC1425
	P30	T9125 T9135 T6130	MC6025 UE6035	AC8025P AC830P	GC4225 GC4235 GC4325	CA5525 CA5535 CA530	HG8025 GM8035 GM25	JC215V JC325V		TP2500 TP3500 TP2501	KC9140 KC9225 KCP30	IC8080 IC656 IC9350	TT8125 TT5100 TT8135	TN30P TN30M WP35CT	WPP30 WAK30 WPP30S	CTCP125 CTC1425 CTC1135 CTC1435 CTC2135
	P40	T9135 T6130	UE6035 UH6400	AC830P AC630M	GC4235	CA5535 CA530	GM8035 GX30	JC325V		TP3500	KC9140 KC9240 KCP40	IC9350 IC635	TT8135 TT7100	TN30P TN30M	WPP30 WAK30 WPP30S	CTC1135 CTC1435 CTC2135
M	M10	T9115	MC7015	AC610M	GC2015	CA6515		JC110V			KCM15	IC9250 IC520M	TT9215	TN15M WM15CT		CTCP115
	M20	T6120 T9125	MC7015 US7020 MC7025	AC6030M	GC2015 GC2025	CA6525	HG8025 GM25	JC110V		TM2000	KCM15 KCM25	IC9025 IC9350 IC4050	TT9215 TT9225	TN15M WM25CT		CTC1425 CTCP125 CTC1135
	M30	T6130	MC7025 US735	AC6030M AC630M	GC2025 GC235		GM8035 GM25 GX30	JC215V		TM2000 TM4000	KCM25 KCM35	IC9350 IC4050 IC635	TT9225 TT9235	TN30M WM35CT		CTC1435 CTC2135
	M40		US735		GC235		GX30			TM4000	KCM35 KCP40	IC635	TT9235			
K	K01	T5105	MC5005 UC5105	AC405K	GC3205	CA4505	HX3505	JC050W JC105V	CP1	TK1001 TK1000	KCK05	IC8080		WK05CT	WAK10 WPP01	
	K10	T515 T5105 T5115	MC5015 UC5115	AC415K	GC3210	CA4515	HX3515 GM10 HG8010	JC105V JC110V	CP1	TK1001 TK1000	KCK05 KCK15	IC9150 IC5100 IC4100	TT7005	WK05CT	WAK10 WPP10 WKK10S	CTC3110 CTC1425
	K20	T515 T5115 T5125	MC5015 UC5115	AC420K	GC3215	CA4515	HX3515 GM8020	JC110V JC215V	CP1	TK2000 TK2001	KCK15 KCK20	IC9150 IC5100 IC4100 IC9080	TT7310	WK20CT	WAK20 WPP20 WKK20S	CTC1435 CTCK120 CTCP115
	K30	T5125 T9115					HG8025	JC215V			KCP25	IC520M IC4050			WAK30 WKP30S	CTCP125

Note: The above table is selected from a publication. We have not obtained approval from each company.

User's Guide- Technical Reference

Grade Comparison Chart

●PVD Coated Grade for Turning

ISO		Tungaloy	Mitsubishi Carbide	Sumitomo Electric	Sandvik	Kyocera	Mitsubishi Hitachi Tool	Dijet	NTK	Seco Tools	Kennametal	Iscar	TaeguTec	Widia	Walter	Ceratizit		
Classification	Symbol																	
P	P01					PR1005										WXN10		
	P10	AH710	VP10RT		GC1525	PR930	IP2000	JC5003	VM1 DT4 DM4	TS2000 CP200	KC5010 KC5510 KCU10	IC507 IC807 IC907		WS10PT	WSM10 WSM21			
						PR1005		JC5030										
							PR1115											
							PR1215											
						PR1425												
P	P20	AH120 AH725 AH730 SH725 SH730 J740	VP10RT VP15TF VP20MF VP20RT UP20M	AC520U	GC1525 GC1125	PR930	IP2000 IP3000	JC5030	VM1 DT4 DM4	TS2500 CP200	KC5025 KC5525 KCU25	IC507 IC807 IC907	TT9030	WS10PT WS25PT	WSM20 WSM21			
						PR1025		JC5040										
							PR1115											
							PR1215											
							PR1425											
						PR1225												
P30	AH120 AH725 SH725 AH730 SH730 GH730 GH330 J740	VP15TF VP20MF VP20RT UP20M	AC530U	GC1125	PR1025 PR1225	IP3000	JC5040	DT4 DM4 QM3	CP500	KC5025 KC5525 KCU25	IC328 IC928 IC3028	TT9030 TT8020	WS25PT	WSM30	CTP1235 CTP1625 CTP2235			
P40	AH120 AH725 AH645		AC530U						CP500		IC328 IC3028	TT8020				CTP1235 CTP2235		
M	M01											IC520				WXM10		
	M10	AH630	VP10RT		GC1105 GC1115 GC1525	PR1025 PR1215	IP100S IP050S	JC5003 JC8015	TM4 ZM3	TS2000 TS2500 CP200	KC5010 KC5510 KCU10	IC520 IC507 IC807 IC907		WS10PT	WSM10 WSM10S			
	M20	AH630 AH120 AH725 SH725 SH730 AH8015	VP10RT VP15TF VP20MF VP20RT UP20M	AC520U	GC1115 GC1125 GC1525	PR930 PR1025 PR1125 PR1215 PR1425 PR1225	IP100S IP050S	JC5015 JC5030 JC8015	TM4 ZM3 DT4 DM4	TS2500 CP200 CP500	KC5025 KC5525 KCU25	IC520 IC507 IC807 IC907 IC308 IC3028	TT9030 TT8010	WS10PT WS25PT	WSM20 WSM21 WSM20S	CTP1235 CTP2120		
M30	AH645 AH120 AH725 SH725 SH730 J740	VP15TF VP20MF VP20RT UP20M MP7035	AC530U AC6040M	GC1125 GC2035	PR1125	IP100S	JC5015 JC5030 JC5040	TM4 ZM3 DT4 DM4	CP500	KC5025 KC5525 KCU25	IC3028 IC308 IC908 IC928	TT8020	WS25PT	WSM30 WSM30S	CTP1235 CTP2120 CTP2235 CTP1625			
M40	AH645	MP7035	AC530U AC6040M	GC2035							IC228 IC328							
K	K01	AH110										IC910						
	K10	GH110 AH110	VP10RT	AC510U		PR905 PR1215		JC5003 JC5015		TS2000 CP200	KC5010 KC5510 KCU10	IC910 IC308 IC508	TT9030	WS10PT		CTP6215		
	K20	AH120	VP10RT VP20RT VP15TF			PR905 PR1215		JC5015		TS2500 CP200 CP250	KC5025 KC5525 KCU25	IC910 IC308 IC508 IC928 IC1008	TT9030	WS10PT WS25PT		CTP6215		
K30	AH120 GH130	VP20RT VP15TF							CP500		IC928 IC1008	TT9030	WS25PT		CTP1625			
S	S01	AH8005	VP05RT MP9005					JC8003								WSM10		
	S10	AH8005 AH8015	VP10RT MP9015	AC510U AC520U	GC1105	PR1305 PR1310		JC8015 JC5015	DT4 DM4	TS2000 TS2500 CP200 CP500	KC5010 KC5510 KCU10	IC507 IC807 IC808 IC907 IC908	TT8010	WS10PT	WSM10 WSM10S	CTP2235		
	S20	AH8015	VP15TF MP9015 VP20RT	AC520U	GC1115 GC1125	PR1310		JC8015 JC5015	DT4 DM4	TS2000 TS2500 CP200 CP500	KC5025 KC5525 KCU25	IC507 IC807 IC808 IC907 IC908	TT8020	WS10PT WS25PT	WSM20 WSM21 WSM20S	CTP2235		
S30	AH630 AH7025	VP15TF VP20RT	AC520U	GC1125	PR1325						IC830 IC928		WS25PT	WSM30 WSM30S				

Note: The above table is selected from a publication. We have not obtained approval from each company.

User's Guide- Technical Reference

Grade Comparison Chart

●Cermet for Turning

ISO		Tungaloy	Mitsubishi Carbide	Sumitomo Electric	Sandvik	Kyocera	Mitsubishi Hitachi Tool	Dijet	NTK	Seco Tools	Kennametal	Iscar	TaeguTec	Widia	Walter	Ceratizit	
Classification	Symbol																
P	P01	NS520	AP25N VP25N	T110A T1000A		TN30 PV30 TN6010 PV7010		LN10	Q15 C7Z		KT1120		PV3010 CT3000				
	P10	GT9530 J9530	AP25N VP25N NX2525	T1500Z T2000Z T1200A T1500A	CT5015	TN60 TN6010 PV7010 TN610 PV710	CZ25	CX50 PX75	C7Z Z15	TP1020 C15M	KT315	IC30N IC530N	PV3010 CT3000	TTI15	WCE10	TCC410 TCM10 TCM407	
	P20	GT9530 NS9530 J9530	AP25N VP25N VP45N NX2525 NX3025	T1200A T1500A T1500Z T2000Z	CT5015 GC1525	TN90 TN6020 PV7020 PV7025 TN620 PV720	CZ25 CH550	CX75 PX75 PX90	C7Z T15	TP1020 TP1030 C15M	KT5020	IC30N IC530N	PV3010 CT3000	TTI15	WCE10	TCC410 TCM10	
	P30	NS9530	VP45N NX4545	T3000Z	GC1525			PX90	N40 C7X								
M	M10	NS520	AP25N VP25N NX2525	T1000A T2000Z	CT5015	TN60 TN6020 PV7020 PV7025		LN10 CX50	C7Z C7X	TP1020 TP1030	KT315 KT5020		PV3010 CT3000	TTI15		TCC410 TCM10 TCM407	
	M20	GT9530 NS9530 J9530	NX2525 AP25N VP25N	T1500A T2000Z	GC1525	TN90 TN6020 PV7020 PV7025	CZ25 CH550	CX75	C7Z C7X	C15M	KT5020	IC30N IC530N	PV3010 CT3000				
	M30	NS9530	NX4545	T3000Z													
K	K01	NS520	AP25N VP25N	T1000A		TN30 PV30 PV7005		LN10					PV3010 CT3000			TCC410	
	K10	GT9530 NS9530 J9530	AP25N VP25N NX2525	T1500A T2000Z	CT5015	TN60 TN6010 PV7005 PV7010	CZ25 CH550	LN10 CX75				KT315 KT5020	IC30N IC530N	CT3000	TTI15		TCC410 TCM10 TCM407
	K20	NS9530	AP25N VP25N NX2525	T3000Z				CX75				KT5020					TCM407

Note: The above table is selected from a publication. We have not obtained approval from each company.

User's Guide- Technical Reference

Grade Comparison Chart

●Cemented Carbide for Turning

ISO		Tungaloy	Mitsubishi Carbide	Sumitomo Electric	Sandvik	Kyocera	Mitsubishi Hitachi Tool	Dijet	NTK	Seco Tools	Kennametal	Iscar	Ingersoll	TaeguTec	Widia	Walter	Ceratizit
Classification	Symbol																
P	P01																
	P10	TH10		ST10P			WS10	SRT			P10	IC70		P10	TN15U		
	P20	KS20	UTi20T	ST20E	SMA H10F		EX35	SRT SR20	KM1	S10M	K125M TTM	IC70	P40	P20	TN15U		
	P30	KS15F UX30	UTi20T	A30 A30N	SM30 H10F	PW30	EX40	DX30 SR30	KM3	S25M	GK K600 TTR	IC28 IC54	P40	P30			S40T
	P40	TX40		ST40E			EX45	SR30		S60M	G13	IC28 IC54		P40			S40T
M	M01																
	M10	TH10		U10E EH510	H10A		WA10B	UMN	KM1	890	K313	IC20		M10	TN15U WU10HT		
	M20	KS20	UTi20T	U2 EH520	H13A		EX35	DX25 UMS		HX 883	K68 KMF K125M TTM	IC20	IN30M	M20	TN15U WU10HT		CTW7120 H210T
	M30	UX30	UTi20T	A30 A30N	H10F SM30		EX45	UMS			GK K600 TTR	IC28	IN30M				
	M40	TU40						UM40			G13	IC28	IN30M	M40			S40T
K	K01	KS05F	HTi05T	H2 H1			WH01 WH05	KG03			K605			UF1	TN15U WU10HT		
	K10	TH10	HTi10	H1 EH10 EH510	H10	KW10	WH10	KG10 KT9 CR1	KM1	890	K313 K110M THM THM-U	IC20 IC09T	IN05S	K10	TN15U WU10HT		H210T H216T H10T
	K20	KS15F KS20	UTi20T	G10E EH20 EH520	H13A H10F	KW10 GW15	WH20	KT9 CR1 KG20 FB15		890 HX 883	K715 KMF K600	IC20 IC09T	IN05S IN10K IN15K IN30M	K20	TN15U WU10HT		CTW7120 H210T H216T H10T
	K30		UTi20T	G10E	H13A H10F	GW25		KG30			883 THR	IC28	IN10K IN15K IN30M	K30			
	K40										G13		IN30M				
N	N01	KS05F		H1	H10	KW10					K605	IC20					
	N10	TH10	HTi10	H1	H10 H10F	GW15	WH10	KT9 CR1	KM1	890 HX KX H15	K313 K110M THM THM-U	IC20 IC28	IN05S IN10K	K10	TN15U WU10HT	WK1 WK10	H210T H216T H10T
	N20	KS15F			H10F H13A		WH20	KT9 CR1	KM1	890 HX KX 883	K715 KMF K600	IC20 IC28	IN10K IN15K	K20	TN15U WU10HT	WK1 WK10	CTW7120 H210T H216T H10T
	N30									883 H25	G13 THR		IN15K IN30M			WK40 WMG40	
	S01		RT9005									IC20					
S	S10	KS05F TH10	RT9005 RT9010	EH510	H10 H10A	KW10	WH10	KG10	KM1	890 883	K10 K313 THM	IC20	IN05S IN10K	K10	TN15U WU10HT	WK1	H210T H216T H10T
	S20	KS15F KS20	RT9010 TF15	EH520	H10F H13A	GW25	WH20	KG20	KM1	890 883 H25	K715 KMF	IC20 IC28	IN10K IN15K	K20	TN15U WU10HT	WK1 WMG40	CTW7120 H210T H216T H10T
	S30		TF15							883	G13 K600 THR		IN15K IN30M			WMG40	
	H01							KG03				IC20					
H	H10	TH10			H13A			FZ05				IC20	IN10K	K10			
	H20							FZ15		890 HX 883			IN15K				

Note: The above table is selected from a publication. We have not obtained approval from each company.

User's Guide- Technical Reference

Grade Comparison Chart

●PCBN and PCD for Turning

ISO		Tungaloy	Mitsubishi Carbide	Sumitomo Electric	Sandvik	Kyocera	Dijet	NTK	Seco Tools	Kennametal	Iscar	Ingersoll	TaeguTec	Widia	Walter	Ceratizit
Classification	Symbol															
K	K01	BX930 BX910 BX870	MB710 MB730 MB5015	BN500 BNC500	CB7525 CB7050 CB50	KBN60M		B52		KB9610 KD120 KB1630	IB10K		KB90	WBH10C	WCB80	TA100 CTL3215
	K10	BX470 BX480 BX950	MB710 MB730	BN7000 BN7500 BN500 BNC500	CB7050 CB7925 CB50	KBN60M	JBN795	B23 B30 B52	CBN200 CBN300 CBN400C CBN010	KB9640 KD120 KB1630	IB05S IB10S		KB90A	WBK40U	WCB80 WCB50	TA120 TA201 CTL3215
	K20	BXC90 BX90S	MB730 MBS140	BNS800	CB7050	KBN900		B23 B30 B52	CBN300 CBN500 CBN600 CBN010	KB1340 KB1345	IB90 IB25KD			WBK45U	WCB80	CTL3215
	K30	BXC90 BX90S	MBS140	BNS800		KBN900		B16	CBN500 CBN600	KB1340 KB1345						
S	S01	M714B	MB730	BN350			JBN795	JP2	CBN170				KB90			
	S10	BX470 BX480 BX950	MB4020	BN7500	CB7050	KBN65B KBN65M		B23 B30	CBN200	KB1630	IB05S IB10S		KB90A	WBK45U	WCB80	TA201
H	H01	BXM10 BX310	BC8110 MBC010 MB810	BNC100 BNC160 BNC2010 BNX10 BN1000	CB20	KBN510 KBN10C KBN05M KBN10M		B52 B5K	CBN10 CBN100 CBN160C CBN050C	KB1610 KB5610	IB05H IB10HC		KB50	WBH10C	WCB30	
	H10	BXM10 BX330 BX530	BC8110 MBC020 MB8025	BNC160 BNC200 BNC2020 BN250 BN1000	CB7015 CB7025 CB20 CB50	KBN525 KBN05M KBN10M KBN25M	JBN245	B36 B52 B6K	CBN150 CBN200 CBN300 CBN060K CBN050C CBN160C CBN300P CBN400C	KB9610 KB1610 KB5610	IB50 IB55 IB10H IB10HC IB20H IB25HA		KB50 TB650	WBH10C WBH10P WBH10U	WCB30 WCB50	CTL3215 TA100
	H20	BXM20 BXA20 BX360	MBC020 BC8120 MB8025 MB825	BNC200 BNC2020 BN250 BNX20 BNX25 BN2000	CB7025 CB20 CB7035	KBN525 KBN05M KBN10M KBN25M	JBN300 JBN330	B22 B36 B40 B6K	CBN150 CBN200 CBN300 CBN060K CBN160C CBN300P CBN400C	KB5625 KB1625	IB20H IB20HC IB25HA IB25HC		TB650	WBH25P	WCB50 WCB80	CTL3215 TA120
	H30	BXC50 BX380	MB835	BNC300 BN350 BNX25	CB7525	KBN35M KBN900	JBN300 JBN330	B22 B40	CBN500	KB1630 KB9640	IB25HC			WBH40C		TA201
N	N01	DX160 DX180	MD205	DA90	CD10	KPD001	JDA30 JDA735			KD1400 KD1405 KD100	ID5				WCD10	CTD4125
	N10	DX140	MD205 MD220	DA150	CD10	KPD001 KPD010 KPD230	JDA715	PD1	PCD05 PCD10	KD100 KD1400 KD1425	ID5	IN90D	KP500	WBN25U	WCD10	CTD4125 CTD4110
	N20	DX120	MD220 MD230	DA2200 DA1000	CD10	KPD001 KPD010 KPD230	JDA715	PD1	PCD05 PCD20	KD1425		IN90D	KP300	WBN25U	WCD10	CTD4205
	N30	DX110	MD230	DA2200 DA1000			JDA10		OVD20 PCD30 PCD30M				KP100			

Note: The above table is selected from a publication. We have not obtained approval from each company.

User's Guide- Technical Reference

Grade Comparison Chart

●Ceramics for Turning

ISO		Tungaloy	Mitsubishi Carbide	Sumitomo Electric	Sandvik	Kyocera	Mitsubishi Hitachi Tool	Dijet	NTK	Seco Tools	Kennametal	Iscar	Ingersoll	TaeguTec	Widia	Walter	Ceratizit
Classification	Symbol																
K	K01	LX11 LX21		NB90S NB90M	CC6190 CC650	KA30 A65 KT66 PT600M			HC1 HW2 SE1 HC2		KY1310 KY1615			AW20 AB30 AS10	CW2015		CTN3105 CTS3105
	K10	CX710 FX105			CC6190 CC650	A65 KT66 A66N PT600M			HC1 HW2 SE1 WA1 WA5		KY1310 KY1320 KY1615 KY3400		IN70N	AB30 AS10	CW2015 CW5025	WSN10	CTN3105 CTM3110 CTI3105 CTN3110 CTS3105
	K20	FX105 CX710			CC6190	KS6000			SP9 SX1 SX8 SX9		KY1320 KY3400 KY3500 KY4300		IN70N	AS10	CW5025	WSN10	CTM3110 CTN3110
H	H01	LX11		NB100C	CC6050 CC650	A65 KT66 A66N PT600M			ZC4 ZC7		KY4300			AW20	CW2015		CTS3105

Note: The above table is selected from a publication. We have not obtained approval from each company.

User's Guide- Technical Reference

Grade Comparison Chart

●CVD Coated Grade for Milling

ISO		Tungaloy	Mitsubishi Carbide	Sumitomo Electric	Sandvik	Kyocera	Mitsubishi Hitachi Tool	Dijet	NTK	Seco Tools	Kennametal	Iscar	Ingersoll	TaeguTec	Widia	Walter	Ceratizit
Classification	Symbol																
P	P01											IC9015 IC5400 IC8080 IC9080			TN2510		
	P10		FH7020	ACP100	GC4220 GC4230			JC730U		MP1500	KCPM20	IC9015 IC5400 IC8080 IC9080 IC4100 IC5100			TN2510 TN7525	WKP25	GM226+
	P20	T3225	FH7020 F7030	ACP100	GC4220 GC4230		GX2140 GX2160	JC730U		MP1500 MP2500 T25M	KCPM20 KCPK30 KCPM30 KC927M	IC8080 IC9080 IC4100 IC5100 IC9250 IC520M	IN6530	TT7800	TN7525 TN7535	WKP25 WKP35 WKP35S	GM226+
	P30	T3130 T3225	F7030	ACP100	GC4230 GC4240 GC2040		GX2140 GX2160			MP1500 MP2500 T350M T25M	KCPK30 KCPM30 KC927M	IC9250 IC520M IC4050 IC635	IN6530	TT7800	TN7525 TN7535	WKP25 WKP35 WKP35S	GM226+ GM246 GM43+
	P40				GC4230 GC4240 GC2040		GX2160			MM4500 T350M	KCPK30 KCPM30	IC4050 IC635	IN6530	TT7800	TN7535	WKP35 WKP35S	GM246 GM43+
M	M10			ACM200	GC2015			JC730U			KCPM20	IC9250 IC520M IC9350			TN7525		
	M20	T3225	F7030	ACM200	GC4230	CA6535		JC730U		MP2500 T350M T25M	KCPM20 KCPM30 KC927M	IC9250 IC520M IC9350 IC4050 IC635	IN6530	TT7800	TN7525 TN7535		CTC5235 GM226+
	M30	T3225 T3130	F7030	ACM200	GC2040 GC4230 GC4240 S40T	CA6535	GX2160	JC730U		MP2500 T350M T25M	KCPM30 KC927M	IC9350 IC4050 IC635	IN6530	TT7800	TN7525 TN7535		CTC5235 CTC5240 GM226+ GM246 GM43+
	M40				GC2040 GC4240 S40T	CA6535	GX2160			MM4500 T350M		IC635	IN6530		TN7535		CTC5235 CTC5240 GM246 GM43+
K	K01		MC5020	ACK200		CA420M		JC605W			KC907M	IC8080 IC4100 IC5100 IC9150			TN2510 TN5505	WKP15	CTC3215
	K10	T1215 T1115	MC5020	ACK200	GC3220	CA420M	GX2120	JC605W JC608X JC610		MK1500	KC907M KC914M KC917M KC924M KCK15	IC8080 IC4100 IC5100 IC9150 IC9080 IC520M		TT6800	TN2510 TN5505 TN5515 TN5520	WKP15 WKP25	CTC3215 SR216 SR226+
	K20	T1215	MC5020	ACK200	GC3220 GC3330 GC3040 GC4220 GC4230	CA420M	GX2120 GX2140	JC605W JC608X JC610		MK1500 MP1500	KC917M KC924M KCK15 KCPM20 KCPK30 KC927M	IC5100 IC9150 IC9080 IC520M IC4050	IN6515 IN6530	TT6800	TN5515 TN5520	WKP15 WKP25 WKP35 WKP35S	SR216 SR226+
	K30		MC5020		GC3330 GC3040 GC4220 GC4230 GC4240		GX2140	JC610		MK1500 MP1500	KCPM20 KCPK30 KC927M	IC520M IC4050	IN6515 IN6530			WKP25 WKP35 WKP35S	

Note: The above table is selected from a publication. We have not obtained approval from each company.

User's Guide- Technical Reference

Grade Comparison Chart

●PVD Coated Grade for Milling

ISO Classification	ISO Symbol	Tungaloy	Mitsubishi Carbide	Sumitomo Electric	Sandvik	Kyocera	Mitsubishi Hitachi Tool	Dijet	NTK	Seco Tools	Kennametal	Iscar	Ingersoll	TaeguTec	Widia	Walter	Ceratizit	
P	P01	AH710 AH110			GC1010		ATH80D JP4105	JC8003			KC505M KC510M KC515M	IC903		TT2510 TT5505	TN2505 TN6505			
	P10	AH120 AH725 AH8015	MP6120 VP15TF	ACP200	GC1010 GC1025	PR830 PR1225 PR1230 PR1525	ATH80D PN08M ATH10E PN15M JP4105 JP4115 JP4120	JC8015 JC5015 JC5118	DM4		KC505M KC510M KC515M KC610M KC715M	IC903 IC907 IC950 IC908 IC910 IC380 IC900	IN2505	TT2510 TT5505 TT5515 TT7080	TN2505 TN2525 TN6425 TN6505	WHH15 WXM15		
	P20	AH120 AH725 AH3135 AH9030	MP6120 VP15TF MP6130 UP20M VP20RT	ACP200 ACP300	GC1025 GC1030 GC2030	PR830 PR1225 PR1230 PR1525	JP4120 JS4045 CY250	JC8015 JC5015 JC5118 JC5040			MP3000 F25M	KC522M KC525M KC527M KC530M KC610M KC620M KC635M KC715M KC720M KC730M	IC907 IC950 IC908 IC910 IC380 IC900 IC830 IC928 IC1008	IN2040 IN2505 IN4005 IN4030	TT2510 TT5505 TT5525 TT7080 TT9030 TT9080	TN2525 TN6425 TN6525	WHH15 WXM15	CTP1235 CTP1625
	P30	AH120 AH725 AH3135 AH130 AH6030	MP6120 VP15TF MP6130 UP20M VP20RT VP30RT	ACP200 ACP300	GC1025 GC1030 GC2030	PR830 PR1225 PR1230 PR1525	JS4045 CY250 JM4160	JC5118 JC5040 JC8050 JC7560			MP3000 F25M F30M F40M	KC525M KC527M KC530M KC537M KC610M KC620M KC720M KC725M KC730M KC735M	IC907 IC950 IC908 IC910 IC380 IC900 IC830 IC928 IC1008	IN2040 IN2505 IN2530 IN4005 IN4030	TT5525 TT7080 TT8020 TT8080 TT9030 TT9080	TN6430 TN6525 TN6540	WSP45 WSP46	CTP1235 CTP1625 CTP2235
	P40	AH140	VP30RT	ACP300	GC1030 GC2030		JM4160	JC5118 JC5040 JC8050 JC7560			MP3000 F40M T60M	KC537M KC720M KC725M KC735M	IC830 IC928 IC1008	IN2040 IN2530 IN4005 IN4030	TT8020	TN6540	WSP45 WSP46	CTP1235 CTP2235
M	M01			ACM100 ACK300	GC1010		PCS08M		DM4			IC907 IC903						
	M10	AH725	VP15TF	ACM100 ACK300 ACP300	GC1010 GC1025 GC1030 GC2030	PR830 PR1225 PR1230 PR1535	PCS08M CY150		DM4		KC515M KC610M KC635M KC720M	IC907 IC903	IN2505	TT5525 TT9030 TT9080	TN6425 TN6525	WXM15		
	M20	AH725 AH3135 AH130 AH6030	VP15TF MP7130 MP7030 UP20M VP20RT	ACM300 ACP300	GC1025 GC1030 GC1040 GC2030	PR830 PR1225 PR1230 PR1535	CY150 CY250	JC8015 JC5015 JC5118	DM4	MP3000 MS2050 F30M F40M	KC522M KC525M KC530M KC610M KC635M KC720M KC730M	IC380 IC900 IC908 IC928 IC1008	IN2005 IN2505 IN2530 IN4005	TT8020 TT8080	TN6425 TN6525	WXM15 WSM35 WSM36	CTP1235 CTP1625	
	M30	AH3135 AH130	VP15TF MP7130 MP7030 UP20M VP20RT MP7140 VP30RT	ACM300	GC1040 GC2030	PR830 PR1225 PR1525 PR1535	CY250 JM4160	JC8015 JC5015 JC5118 JC8050 JC7560		MP3000 MS2050 F30M F40M	KC522M KC525M KC530M KC537M KC725M KC730M KC735M	IC380 IC900 IC908 IC928 IC1008 IC328 IC330	IN2005 IN2505 IN2530 IN4005 IN4030	TT8020 TT8080	TN6540	WSM35 WSM36 WSP45 WSP46	CTP1235 CTP2235	
	M40	AH140	MP7140 VP30RT	ACM300	GC1040	PR1225 PR1525 PR1535	JM4160	JC5015 JC5118 JC8050 JC7560		MS2050 F40M	KC725M	IC1008 IC328 IC330	IN2005 IN2530 IN4005 IN4030	TT8020	TN6540	WSM35 WSM36 WSP45 WSP46	CTP2235	
K	K01	AH110	MP8010		GC1010	PR1510	ATH80D JP4105	JC8003				IC380 IC900		TT6080	TN2505 TN6405 TN6505		AMZ	
	K10	AH110 AH120	MP8010 VP15TF		GC1010 GC1020	PR1210 PR1510	ATH80D JP4105 JP4120 CY150	JC8015		MK2050	KC514M KC515M KC520M KC620M	IC380 IC900 IC810 IC910	IN2015 IN2505 IN4015	TT6080	TN2505 TN6405 TN6505 TN6510	WHH15 WXM15 WKK25	AMZ CTP3220 CTP6215	
	K20	AH120 AH9030	MP8010 VP15TF VP20RT	ACK300	GC1020	PR1210 PR1510	JP4120 CY150 CY250	JC8015 JC5015		MK2050	KC514M KC520M KC522M KC524M KC527M KC610M KC620M KC635M	IC810 IC910 IN2015 IN2505 IN4015 IN4030	IC950 IC350 IC830 IC928	TN2525 TN6510 TN6520 TN6525	WHH15 WXM15 WKK25	CTP3220 CTP1625		
	K30	AH120	VP15TF VP20RT	ACK300		PR1510	CY250	JC8015 JC5015		MK2050	KC522M KC524M KC527M KC537M KC610M KC620M KC635M	IC830 IC928 IC1008 IC808 IC908	IN2015 IN2505 IN4015 IN4030	TN6430 TN6525 TN6540	WKK25			

User's Guide- Technical Reference

●PVD Coated Grade for Milling

ISO		Tungaloy	Mitsubishi Carbide	Sumitomo Electric	Sandvik	Kyocera	Mitsubishi Hitachi Tool	Dijet	NTK	Seco Tools	Kennametal	Iscar	Ingersoll	TaeguTec	Widia	Walter	Ceratizit
Classification	Symbol																
N	N01										KC410M KC510M KC5410			TT6080	TN6501		AMZ
	N10	DS1100		DL1000	GC1025 GC1030		SD5010 HD7010				KC410M KC510M KC5410 KC620M			TT6080 TT8020	TN6501 TN6502	WXN15	AMZ
	N20	DS1200	LC15TF	DL1000	GC1025 GC1030		SD5010 HD7010			F15M	KC422M KC620M			TT8020		WXN15	
S	S01	AH110 AH710		ACM100 ACK300	GC1010	PR905 PR1210 PR1535		JC8003 JC8015			KC510M	IC808 IC907 IC908			TN6405		AMZ
	S10	AH120 AH725 AH130	MP9120 VP15TF MP9130 MP9030	ACM100 ACK300	S30T GC1010 GC1030 GC2030	PR905 PR1210 PR1535	PTH13S JS1025	JC8003 JC8015 JC5015 JC5118		MS2050	KC510M KC610M	IC808 IC907 IC908 IC903	IN2505 IN2530	TT9030 TT9080 TT8080	TN6405 TN6425		AMZ CTP1625
	S20	AH725 AH130 AH6030	MP9120 VP15TF MP9130 MP9030	ACM300	S30T GC1030 GC1040 GC2030 GC2040	PR905 PR1210 PR1535	PTH13S JS1025	JC8015 JC5015 JC5118 JC8050 JC7560		MS2050 F40M	KC522M KC525M KC610M	IC300 IC900 IC830 IC928	IN2505 IN2530	TT8080 TT8020	TN6425	WSM35 WSM36	CTP1235 CTP1625
	S30	AH130	MP9130 MP9030	ACM300	S30T GC1040 GC2040	PR1535		JC5118 JC8050 JC7560		MS2050 F40M	KC522M KC525M KC725M	IC830 IC928	IN2530	TT8020	TN6540	WSM35 WSM36 WSP45 WSP46	CTP1235 CTP2235
H	H01	AH110	MP8010		GC1010			DH102 JC6102 JC8003 JC8008			KC510M	IC903		TT2510 TT5505	TN2505		
	H10	AH110 AH120 AH8015	MP8010 VP15TF		GC1010 GC1025 GC1030		PTH08M JP4105	JC6102 JC8003 JC8008 JC8015 JC5118		MH1000 F15M	KC505M KC510M KC635M	IC903 IC808 IC907 IC908		TT5515 TT6080	TN2505 TN2525	WHH15	CTP6215
	H20	AH120 AH725 AH9030	VP15TF		GC1025 GC1030		JP4105	JC8015 JC5118		F15M	KC635M	IC808 IC907 IC908 IC380 IC900		TT5515 TT6080	TN2525	WHH15	CTP6215
	H30									MP3000 F30M		IC380 IC900 IC1008					

Note: The above table is selected from a publication. We have not obtained approval from each company.

User's Guide- Technical Reference

Grade Comparison Chart

●Cermet for Milling

ISO		Tungaloy	Mitsubishi Carbide	Sumitomo Electric	Sandvik	Kyocera	Mitsubishi Hitachi Tool	Dijet	NTK	Seco Tools	Kennametal	Iscar	Ingersoll	TaeguTec	Widia	Walter	Ceratizit
Classification	Symbol																
P	P01			T250A	CT530	TN60 TN100M	MZ1000						IN0560	CT3000			TCC410
	P10	NS740	NX2525	T250A	CT530	TN60 TN100M TC60M	MZ1000 MZ2000 CH550	NIT CX75 CX90		MP1020	KTPK20	IC30N	IN0560 IN60C	CT3000 CT7000	TTI25		TCC410 TCM10
	P20	NS740	NX2525 NX4545	T250A T4500A		TN60 TN100M TC60M	MZ2000 MZ3000 CH500 CH7030	NIT CX75 CX90 SC30		MP1020	KTPK20	IC30N	IN60C	CT3000 CT7000	TTI25		TCM10
	P30		NX4545	T4500A			MZ3000 CH7035		C7X			IC30N	IN0545	CT7000			
M	M10	NS740	NX2525	T250A	CT530	TN60 TN100M TC60M	MZ1000 CH550	NIT CX75			KTPK20	IC30N	IN0560	CT3000 CT7000	TTI25		TCC410
	M20	NS740	NX2525 NX4545	T250A T4500A		TN60 TN100M TC60M	MZ2000 MZ3000 CH500 CH7030	NIT CX75 SC30	C7X	MP1020	KTPK20	IC30N		CT7000	TTI25		TCC410 TCM10
	M30		NX4545	T4500A			MZ3000 CH7035	SC30									
K	K01						MZ1000 CH550	NIT									TCC410
	K10	NS740	NX2525				MZ2000 MZ3000 CH500 CH7030	NIT CX75			KTPK20			CT7000			TCC410 TCM10
	K20						MZ2000 MZ3000 CH500 CH7030 CH7035	CX75			KTPK20						

Note: The above table is selected from a publication. We have not obtained approval from each company.

User's Guide- Technical Reference

Grade Comparison Chart

●Cemented Carbide for Milling

ISO		Tungaloy	Mitsubishi Carbide	Sumitomo Electric	Sandvik	Kyocera	Mitsubishi Hitachi Tool	Dijet	NTK	Seco Tools	Kennametal	Iscar	Ingersoll	TaeguTec	Widia	Walter	Ceratizit
Classification	Symbol																
P	P01																
	P10																S26T
	P20		UTi20T	A30N			EX35				K125M	IC50M		P30	TTM		S26T
	P30	UX30	UTi20T	A30N	SM30		EX40				K125M	IC50M IC28		P30	TTM TTR		S26T
	P40				SM30							IC28			TTR		
M	M01																
	M10											IC20 IC07 IC08					S26T
	M20		UTi20T		SM30							IC07 IC08			TTM		S26T
	M30		UTi20T	A30N	SM30							IC28			TTM TTR		S26T
	M40			A30N								IC28			TTR		
K	K01					KW10					K115M K313			K10	THM-F		
	K10	TH10	HTi10	G10E	H13A	KW10 GW25	WH10				K115M K313 K110M	IC20		K10	THM-F THM		CTW4615 H216T
	K20		HTi10 UTi20T	G10E	H13A	KW10 GW25				HX	KMF	IC20	IN10K		THM THR		CTW4615 H216T
	K30		UTi20T								KMF		IN10K		THR		
	K40												IN10K				
N	N01	KS05F	HTi10		H10	KW10					K115M				THM-U	WK10	
	N10	TH10	HTi10		H10 H13A H10F	KW10 GW25	WH10			H15	K115M K313 K110M	IC20 IC08		K10 UF10	THM-U THM-F THR-S	WK10	CTW4615 H216T
	N20	KS15F	HTi10 TF15	H1	H13A H10F	KW10 GW25				HX H15 H25	KMF K313 K110M	IC20 IC08 IC28		K10 UF10	THM-F THR-S THM	WMG40	CTW4615 H216T
	N30		TF15	H1						H25	KMF	IC28				WMG40	
	S01					KW10					K313	IC20					
S	S10			EH520	H13A	KW10 GW25		FZ15			K313 K110M	IC20 IC07 IC08			THM-F		
	S20	KS20		EH520	H10F H13A	KW10 GW25		FZ15		HX H25	KMF	IC20 IC07 IC08 IC28			THM		
	S30				H10F							IC07 IC08					
	H01				H1P			FZ05									
H	H10				H1P			FZ05 FZ15				IC20			THM-F		
	H20							FZ15									

Note: The above table is selected from a publication. We have not obtained approval from each company.

User's Guide- Technical Reference

Chipbreaker Comparison Chart

●Negative insert type

ISO Classification	Cutting Mode	Tungaloy	Mitsubishi Carbide	Sumitomo Electric	Kyocera	Sandvik	Mitsubishi Hitachi Tool	Kennametal	Dijet	Iscar	TaeguTec	Widia	Walter	Ceratizit	
P	Precision finishing	01 TF	PK FH	FA	DP	QF	FE	FS, LF	PF	SF, PP, TF	FA				
	Finishing and light cutting	TS, TSF ZF 11, NS AS TQ NM CB C	SA FY C SH MP	SU FL SE, SX	PQ, VF CJ PQ GP, PP HQ GS CQ	PF, QF LC MF R/L-K	BE, BH AB, CT CE	FF, FN	UA, FT UR, UT	F3P NF, SF	FG VF, EA FC MC ML, MP	4 AP	NF3 NS6	CF, TF	
		Finishing and light cutting (With Wiper)	AFW, FW ASW, SW	SW	LUW SEW GUW	WP WQ	WL, WF WMX WM, WR	FW MW RW	WF WG	WS WT	FW MW	NF NM	TFQ TMQ		
		Medium cutting	TM, AM DM, ZM All-round	MA MH, MP	GU GE, UX	HS, PT, GT CS, PS	PM, QM XM, XRM	AH AE, AY, B	P MN	PG, UB GN GNP	M3P, M3M PP, TF, GN	PC, MT MC, MG-	48	NMT, NM4	TMF, TMM M50
		Medium to heavy cutting	TH THS	RP, GH HZ, HL	MU, ME HG	PH All-round	HM, PR MR	RE	RN, RP MR	GG, UD	NR MR	RT	49	NM5, NM6 NM9	TM TRM
		Heavy cutting	TU TRS TUS	HM, HX HU, HW HV	HG, HP HF	PX	PR, MR HR, QR	TE, UE HX, HE H	RM RH	UC	R3P NM	HT, HD RX, RH HY, HZ	NR6 NRF NRR	TRR, TR R28, R58 R88	
M	Finishing and light cutting	SF, SA SS	GM, MS SH, LM	EX, EG SU, EF	GU MQ	MF, XF LC, R/L-K	MP BH, AB	FP	SF	TF, VL	EA, SF, SU FG	NF4 NMS	CF, F30, M34 F32, TF		
	Medium cutting	SM S	MM, MA ES	GU HM	TK MU	MM, QM XM, XRM	PV, SE DE	MP, P	SZ	M3M, PP	EM, ET	NM4	TMF, M42 M30, M52		
	Heavy cutting	TH, SH TU	GH, RM, HZ	EM, MU	MS	MR HM, PR	AH, AE	UP, RP	SG	MR, MH	SR	NR4 NRT, NRS	TRM, TMR, TRR R80		
K	Finishing	CF	LK, MA	UZ	C	KF, XF	Y, AH	FN		GN	FG		CF		
	Medium cutting	CM All-round	MK GK	GZ	ZS All-round	KM, QM XM, XRM	V, AE VA	RP, UN	PG		MT MG		NM5 M50		
	Heavy cutting	CH Without chipbreaker	RK Without chipbreaker	Without chipbreaker	Without chipbreaker	Without chipbreaker	Without chipbreaker	Without chipbreaker	Without chipbreaker	GG, UD Without chipbreaker	RT	Without chipbreaker	TMR, TR R28 R58, R88		
N	Cutting of non-ferrous metals	P		AX	AH, A3	MF QM	Without chipbreaker	MS, MP MG		PP	ML		F32		
S	Finishing	HRF	FJ, LS	EF EX	MQ	SF 01		FS, LS MS			SF		NFT NF4		
	Medium cutting	HRM HMM SA	MS RS, GJ	EG MU	TK, MS, MU	MM, QM SMR		UP, P, NGP RP		PP	SU	SM	NMS M34, M52 NM4, NRS, NR4		

Note: Above charts are based on published data and not authorized by each manufacturer.

User's Guide- Technical Reference

Chipbreaker Comparison Chart

●Positive insert type

ISO Classification	Cutting Mode	Tungaloy	Mitsubishi Carbide	Sumitomo Electric	Kyocera	Sandvik	Mitsubishi Hitachi Tool	Kennametal	Dijet	Iscar	TaeguTec	Widia	Walter	Ceratizit	
P	Precision finishing	01	FV , SMG	FC , FW	CF CK		No sign MP	UF		SF		2	PF2	F32	
	Finishing and light cutting	PSF , PF , SS PS , PSS , TS	FP , FV , SV LP	FP , FZ , LU FK , SS , SC SU , SK , SF US	GQ , GK GP , HQ XP , XQ	R/L-K PF , XF UF , PM	JQ	11 , GM LF	FT	PF SM , 14 , 17 19 , XL	FA FG	41	PF5 PF4 PS5	SF SMF	
		TSW W08-20	SW , MW R/L, R/L-FD R/L-FS R/L-MV R/L-F, R/L-L	LUW , SDW W , SD FX , FY	WF, WK, WM					R/L RF , LF	GF		PF , PM	SMQ , 25Q	
	Medium cutting	PM 23 24 All-round RS	MP MV No sign	SU , MU UJ SC (except for G-class inserts) RP	All-round VF , MF	PM , XM UM, PR, XR UR	JE	GM, MP, MR		DT, HQ	MT		PM5	SM	
		High-feed, small depth of cut cutting	61	No sign			No mark	WE			No sign 14	No sign	No sign		
M	Finishing	PSF , SS	FM , FV , SV	FC		R/L-K UF , MF	MP	GM , LF			FG	41			
	Finishing to Medium cutting	PSS PS	LM SV		MQ	MM , XM UM	JQ	MF					PF4	SF , SMF	
	Medium cutting	PM	MM , MV	MU		MR , XR UR	JE						PM5	F23 , F43 SM	
K	Cutting of cast irons	CM Flat-top	MK Flat-top	Flat-top	Flat-top	KF, XF KM, XM UM, KR, XR AL	JQ , JE	Flat-top	Flat-top	19	MT Flat-top		PS5 , PM5 Flat-top	SF 25P 27 , 29	
N	Cutting of non-ferrous metals	AL PP	AZ	AG AX , AY	AH , A3			GT-HP		AS	FL	AL1, AL2 , AL3	PF2 PM2	23P 25P 27 , 29	
		Ground	R/L-F R/L												
S	Finishing	PSF	FJ	FC	MQ	MF, UF, R/L-K								SF	
	Finishing to Medium cutting	PSS PS		FX , FY		MM , XM								F23	
	Medium cutting	All-round		SI		UM, MR, UR, XR					FG		PF2 , PF4	SM , 25P , 29	
P M N S	Turning on small lathes	01 W08, W15, W20 J10	R/L-SR R/L-SN R/L-SS FS , F	W , SD FX , FY	R/L-F, R/L-FSF ER/L-U FR/L-U R/L-U FR/L-U, R/L-USF MF, R/L-FSF	F , M	No sign		MF , MM ALU , MM1 ASF FT , ACB		GF , GW		PM5		
		JRP, JSP, JPP TS , JTS TSW SS , JSS	SW , MW	LUW , SDW											
		JS		LU, FP, FK, SU FB , LB FC , SI , SC	GK E-GK										
		SMG													

Note: Above charts are based on published data and not authorized by each manufacturer.

User's Guide- Technical Reference

Unified symbols for cutting conditions and tool dimensions

Standardized symbols for cutting conditions and tool specifications are used in order to avoid confusion caused by each manufacturer's using its own symbols.

(Quantity symbols of cutting conditions) Symbol / Unit

Turning	Cutting speed		Feed		Depth of cut		Cutting edge width		Min. bore diameter	
	V_c	sfm	f	ipr	a_p	in	W	in	ϕD_m	in
	Power consumption		Specific cutting force		Theoretical surface roughness		Corner radius		Number of revolutions	
	P_c	kW	k_c	psi	h	μm	r_ϵ	in	n	rpm
Milling	Cutting speed		Feed speed		Feed per tooth		Feed		Number of teeth	
	V_c	sfm	V_f	ipm	f_z	ipt	f	ipr	z	
	Axial depth of cut		Radial depth of cut		Pick feed		Power consumption		Specific cutting force	
	a_p	in	a_e	in	P_f	in	P_c	kW	k_c	psi
	Chip removal rate		Number of revolutions							
	Q	in ³ /min	n	rpm						
Drilling	Cutting speed		Feed speed		Feed		Tool diameter		Power consumption	
	V_c	sfm	V_f	ipm	f	ipr	ϕD_c	in	P_c	kW
	Torque		Thrust force		Specific cutting force		Drilling depth		Number of revolutions	
	M_c	lbf-ft	T_c	N	K_c	psi	H	in	n	rpm

Dimensional symbols of turning tools

● External turning tools

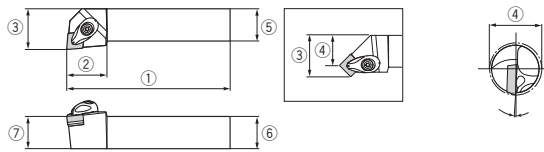

①	②	③	④	⑤	⑥	⑦
Overall length	Head length	Distance to cutting edge	Distance to cutting edge	Shank width	Shank height	Cutting edge height
L_1	L_2	f	f_1	b	h	h_1

● Internal turning tools

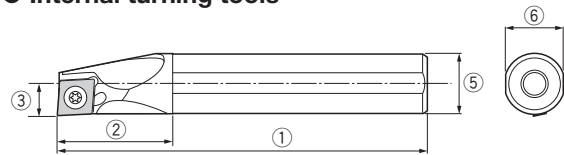

①	②	③	④	⑤	⑥
Overall length	Head length	Distance to cutting edge	Minimum bore diameter	Shank diameter	Shank height
L_1	L_2	f	ϕD_m	ϕD_s	h

● External and face grooving tools

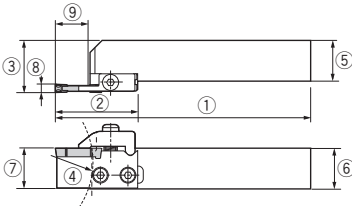

①	②	③	④	⑤
Overall length	Head length	Distance to cutting edge	Maximum grooving diameter	Shank width
L_1	L_2	f	ϕD_m	b
⑥	⑦	⑧	⑨	
Shank height	Cutting edge height	Cutting edge width	Maximum grooving depth	
h	h_1	w	ar	

● Internal grooving tools

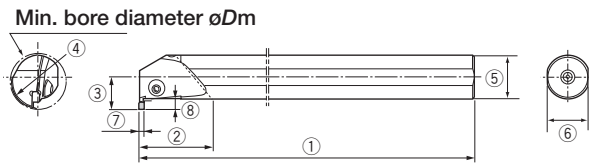

①	②	③	④
Overall length	Head length	Distance to cutting edge	Maximum grooving diameter
L_1	L_2	f	ϕD_m
⑤	⑥	⑦	⑧
Shank diameter	Shank height	Cutting edge width	Maximum grooving depth
ϕD_s	h	w	ar

● External threading tools

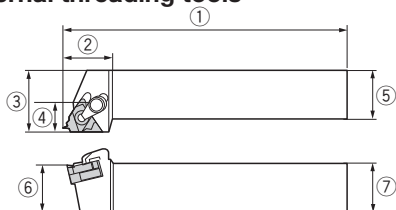

①	②	③	④	⑤	⑥	⑦
Overall length	Head length	Distance to cutting edge	Shoulder width	Shank width	Shank height	Cutting edge height
L_1	L_2	f	-	b	h	h_1

● Internal threading tools

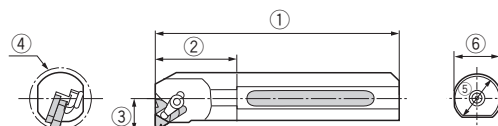

①	②	③	④	⑤	⑥
Overall length	Head length	Distance to cutting edge	Maximum grooving diameter	Shank diameter	Shank height
L_1	L_2	f	ϕD_m	ϕD_s	h

User's Guide- Technical Reference

Dimensional symbols of milling tools

● Bore type milling tools

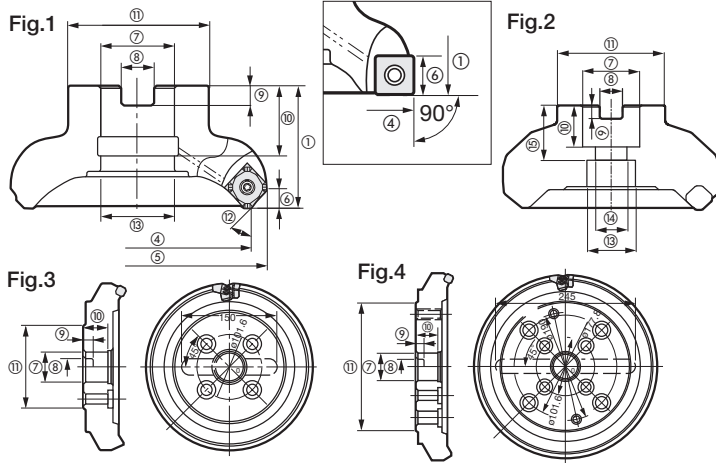

● Shank type milling tools

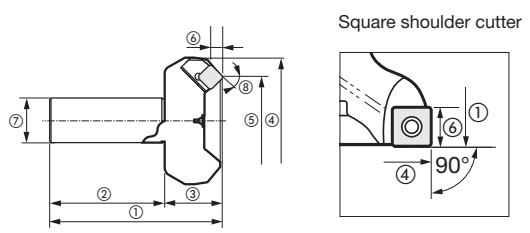

①	②	③	④
Overall length	Shank length	Cutter height	Cutter diameter
L	l_s	L_f	ϕD_c
⑤	⑥	⑦	⑧
Maximum outer diameter	Maximum depth of cut	Shank diameter	Corner angle
ϕD_1	ap	ϕD_s	κ

①	④	⑤	⑥	⑦	⑧	⑨	⑩	⑪	⑫	⑬	⑭	⑮
Cutter height	Cutter diameter	Maximum outer diameter	Maximum depth of cut	Hole diameter	Keyway width	Keyway depth	Mounting hole depth	Mounting flat diameter	Corner angle	Mounting bolt counter bore dia.	Mounting bolt hole diameter	Mounting bolt hole depth
L_f	ϕD_c	ϕD_1	ap	d	a	b	l	ϕD_b	κ	ϕd_1	ϕd_2	l_1

Dimensional symbols of endmills

● Square endmills

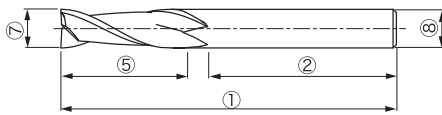

● Taper-neck ball endmills

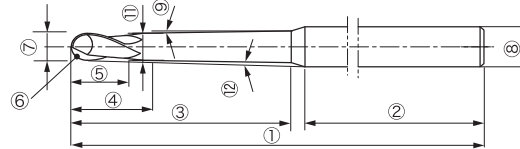

● Radius endmills

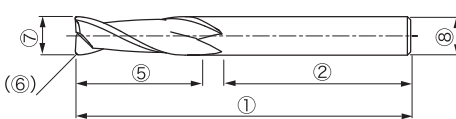

● Taper square endmills

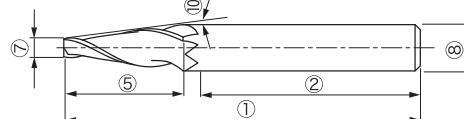

①	②	③	④	⑤	⑥ Ball end	⑦ Radius end	⑧	⑨	⑩	⑪	⑫	⑬	
Overall length	Shank length	Neck length	Length of parallel portion	Cutting edge length	Ball radius	Corner radius	Tool diameter	Shank diameter	Half angle of neck taper	Half angle of cutting edge taper	Neck diameter	Interference angle	Helix angle
L	l_s	l_2	l_1	l	R	r	ϕD_c	ϕD_s	θ_n	θ_c	ϕD_1	$\theta \kappa$	λ

Dimensional symbols of side cutters

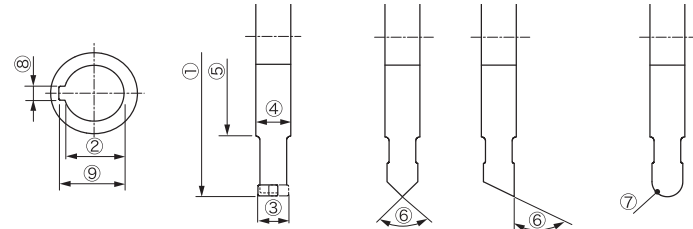

①	②	③	④	⑤
Cutter diameter	Bore diameter	Cutting edge width	Boss thickness	Boss diameter
ϕD_c	ϕd	l	T	ϕD_b
⑥	⑦	⑧	⑨	⑩
Cutting edge angle	Corner radius	Keyway width	Keyway depth	Number of teeth
α	R	a	b	z

Dimensional symbols of drills

● Solid straight drills

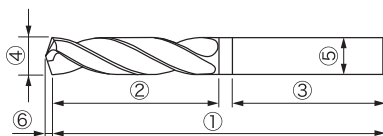

①	②	③	④	⑤	⑥
Overall length	Flute length	Shank length	Drill diameter	Shank diameter	Point length
L	l	l_s	ϕD_c	ϕD_s	L_p

● Solid step drills

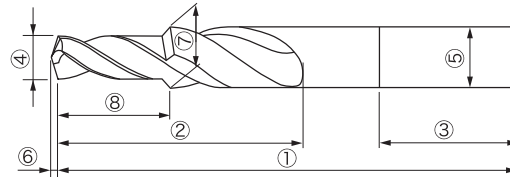

①	②	③	④	⑤	⑥	⑦	⑧
Overall length	Flute length	Shank length	First step drill diameter	Shank diameter	Point length	Second step drill diameter	Step length
L	l	l_s	ϕD_c	ϕD_s	L_p	ϕD_{c2}	l_1

Alphanumeric --- Index



User's Guide - Alphanumeric Index

Designation	Page
1/8-28	G007
1/4HEX	C025, G024
1/8HEX	G024
10ER/L*B	B158, B384
10ER/L300	B158, B384
11IR**ISO-B	B421
11IR**ISO-M	B421
11IR**PT	B425
11IR**UN	B422
11IR**W	B424
11IR/L**ISO	B420
11IR/LA60	B418
11IRA55	B419
11IRA60-B	B418
11IRA60-M	B418
15GR/L...	C033
16D.RINGSEMC	F124
16ER**55	B419
16ER**55-B	B419
16ER**60-B	B418
16ER**60-M	B418
16ER**ACME	B428
16ER**ISO-B	B421
16ER**ISO-M	B421
16ER**NPT	B426
16ER**NPT-B	B426
16ER**NPTF	B427
16ER**NPT-M	B426
16ER**PT	B425
16ER**PT-B	B425
16ER**PT-M	B425
16ER**RAPI	B429
16ER**RD-B	B430
16ER**RD-CB	B429
16ER**TR	B428
16ER**UN	B422
16ER**UN-B	B423
16ER**UNJ	B430
16ER**UN-M	B423
16ER**W-B	B424
16ER**W-M	B424
16ER/L*60	B418
16ER/L**ISO	B420
16ER/L**W	B424
16ER8TPI29(STACME)	B428
16IR**55	B419
16IR**55-B	B419
16IR**60-B	B418
16IR**60-M	B418
16IR**ACME	B428
16IR**ISO-B	B421
16IR**ISO-M	B421
16IR**NPT	B426
16IR**NPT-B	B426
16IR**NPTF	B427
16IR**NPT-M	B426
16IR**PT	B425
16IR**PT-B	B425
16IR**PT-M	B425

Designation	Page
16IR**RAPI	B429
16IR**RD-B	B430
16IR**RD-CB	B429
16IR**TR	B428
16IR**UN	B422
16IR**UN-B	B423
16IR**UN-M	B423
16IR**W	B424
16IR**W-B	B424
16IR**W-M	B424
16IR/L*60	B418
16IR/L**ISO	B420
16IR6RD-B	B430
16IR8TPI29(STACME)	B428
1QP-CCGW...	B173
1QP-EPGW...	B173
22D.RINGSEMC	F124
22ER**ISO	B421
22ER**ISO-B	B421
22ER**TR	B428
22ER**ACME	B428
22ER**TPI29(STACME) AH725	B428
22ER*UN	B422
22ER*W	B424
22ER/LN60	B418
22ER5BAPI	B429
22ERN55	B419
22ERN60-B	B418
22IR**ISO	B421
22IR**TR	B428
22IR**ACME	B428
22IR**TPI29(STACME) AH725	B428
22IR*UN	B422
22IR*W	B424
22IR/LN60	B418
22IR5BAPI	B429
22IRN55	B419
22IRN60-B	B418
27D.RINGSEMC	F124
27ER60ISO	B421
27ER60TR	B428
27ERZ60	B418
27IR60ISO	B421
27IRZ60	B418
2QP-CCGW...	B170
2QP-CCMW...	B172
2QP-CNGA...	B165
2QP-CNGA**F	B165
2QP-CNGA**H	B165
2QP-CNGA**L	B165
2QP-CNGA**W	B165
2QP-CNGA**WL	B165
2QP-CNGM**HF	B168
2QP-CNGM**HM	B168
2QP-CNMA**W	B165
2QP-DCGW...	B170
2QP-DCGW**F	B170

Designation	Page
2QP-DCMW...	B172
2QP-DNGA...	B165
2QP-DNGA**H	B165
2QP-DNGA**L	B165
2QP-DNGA**WJ	B165
2QP-DNGM**HF	B168
2QP-DNGM**HM	B168
2QP-GNGA...	B165
2QP-SNGA...	B166
2QP-SNGA**H	B166
2QP-SNGA**L	B166
2QP-SNGN...	B166, D261
2QP-SPGN...	B170, D261
2QP-SPGW...	B170, D261
2QP-SPMN...	B172
2QP-VBGW...	B171
2QP-VBMW...	B172
2QP-VCGW...	B171
2QP-VCMW...	B172
2QP-VNGA...	B167
2QP-VNGA**H	B167
2QP-VNGA**L	B167
2QP-VNGM**HF	B168
2QP-VNGM**HM	B168
3/32HEX	G024
30S**R/L	C106 - C109
32D.RINGSEMC	F124
3QP-TNGA...	B166
3QP-TNGA**F	B166
3QP-TNGA**H	B166
3QP-TNGA**L	B166
3QP-TNGA**WG	B166
3QP-TNGM**HF	B168
3QP-TNGM**HM	B168
3QP-TPGN...	B170, D261
3QP-TPGW...	B170, D261
3QP-TPGW**F	B170
3QP-TPMN...	B172
3QP-TPMW...	B172
3QP-TPU...	B172
3QP-WNGA...	B167
3QP-WNGA**WL	B167
40D**R/L	C106 - C109
40D.RINGSEMC	F124
40S**R/L	C106 - C109
4QP-CNGA...	B165
4QP-CNMA**W	B165
4QP-DNGA...	B166
4QP-SNGA...	B166
4QP-VNGA...	B167
5/32HEX	G024
50D**R/L	C106 - C109
50D.RINGSEMC	F124
50S**R/L	C106 - C109
6GR/L...	C033
6IR**ISO	B420
6IR18NPT	B426
6IR19PT	B425
6IR19W	B424

User's Guide - Alphanumeric Index

Designation	Page
CGWSRL...	C095, C110
CGWSR/L**-*GR/L	C100
CGWSR/L**-*CGDR/L...	C116
CGWSR/L**-*FLR/L*GP	C118
CGWSR/L**-*FLR/L5TP	C119
CGWSR/L**-*W**GR/L	C094
CGWSR/L**-*W**GR/L-L	C094
CGWSR/L**-*W**L	C093
CGWSR/L**-*W...	C093
CGWTR/L...	C096, C111
CGWTR/L**-*GL/R	C101
CGWTR/L0040-FLL/R3NP	C119
CGXR/L...	C034
CH44-A	G011
CHFVR/L...	C065, C075
CHHM*...	G004
CHP-CONNECTOR/5/16-G1/8	B230, B378, C136
CHP-COPPER-SEAL...	B230, B378, C054, C136
CHP-HOSE-**-2**B...	B230, B378, C054, C136
CHP-NIPPLE-G1/8-7/16UNF	B230, C054, C136
CHSNR16M45-RD	B273
CHSR/L...	C064, C075
CKJNR/L...	B256
CLVOR...	B470
CM**x**x...	G004, G005
CM*X**X**-*A	G004, G005
CNGA...	B061
CNGA**-*DIA	B178
CNGA**-*QBN	B169
CNGA**-*R-3E	B470
CNGA-5B75-3E	B470
CNGD...	B062
CNGG**-*01	B052
CNGG**R/L-C	B052
CNGG**R/L-P	B058
CNGN...	B062
CNGP...	B057
CNGR/L...	C032
CNMA...	B061
CNMA**W	B061
CNMG...	B056
CNMG**-*11	B053
CNMG**-*AFW	B052
CNMG**-*AM	B055
CNMG**-*AS	B054
CNMG**-*ASW	B054
CNMG**-*CB	B054
CNMG**-*CF	B053
CNMG**-*CH	B060
CNMG**-*CM	B058
CNMG**-*DM	B056
CNMG**-*FW	B052
CNMG**-*HMM	B058
CNMG**-*HRF	B053
CNMG**-*HRM	B058
CNMG**-*NM	B055
CNMG**-*NS	B055

Designation	Page
CNMG**R/L-S	B059
CNMG**-*SA	B059
CNMG**-*SF	B053
CNMG**-*SH	B060
CNMG**-*SM	B058
CNMG**-*SS	B055
CNMG**-*SW	B054
CNMG**-*TF	B052
CNMG**-*TH	B059
CNMG**-*THS	B059
CNMG**-*TM	B055
CNMG**TN17	B053
CNMG**TN27	B057
CNMG**TN28	B057
CNMG**TN33	B057
CNMG**TN37	B057
CNMG**TN38	B057
CNMG**-*TQ	B056
CNMG**-*TS	B054
CNMG**-*TSF	B052
CNMG**-*ZF	B053
CNMG**-*ZM	B056
CNMG**E-FW	B052
CNMG**E-SM	B058
CNMG**E-SS	B055
CNMG**E-SW	B054
CNMG**E-TM	B055
CNMG**E-TSF	B052
CNMG**E-ZF	B053
CNMG**E-ZM	B056
CNMM**-*DIA	B178
CNMM**-*TRS	B060
CNMM**-*TU	B060
CNMM**-*TUS	B060
CNMN...	B062
CNR/L...	B436
CNZ125	F014, G021
COOLINGTUBEHSK...	F124
CP...	G015
CP81A	G014
CP81B	G014
CPGA**-*DIA	B180
CPGA**-*QBN	B174
CPGT**FR/L-W15	B114
CPGT**R/L-W20	B114
CPK5R/L	G015
CPMT...	B115
CPMT**-*24	B114
CPMT**-*CM	B115
CPMT**-*EN	D217
CPMT**-*PF	B113
CPMT**-*PM	B115
CPMT**-*PS	B113
CPMT**-*PSF	B113
CPMT**-*PSS	B113
CPMW...	B115
CPMW**-*EN	D217
CPW5	G023
CQ-1	G015

Designation	Page
CR-**NPT-4E	B470
CR-**NPT-4I	B471
CR-**R-3E	B470
CR-**R-3I	B471
CR-5B75-3E #*	B472
CR-5B75-3I	B471
CR-5B75-4E	B470
CR-8R-3E #*	B472
CRW...	G023
CS44-A	G009
CSBNR/L...	B256
CSBPR/L...	B258
CSDNN...	B257
CSDPN...	B259
CSG-**	G016
CSG-*S	G016
CSG-5T	G016
CSG-6L	G016
CSHB-...	G004
CSHB-*A	G004
CSHM-3-8	G004
CSK54R/L	G011
CSKNR/L...	B257
CSL-4	G016
CSP...	G016
CSP-2L033	G002
CSPA-..	G002
CSPB-...	G002, G003
CSPD-...	G003
CSSNR/L...	B257
CSSNR/L16M45-RD	B273
CSSPR...	B259
CST-...	G003
CSTA-...	G002
CSTB-...	G002
CSTB-4.5L110P	G003
CSTC-**DR/L	G002
CSTC-2	G003
CSTD-3T	G003
CSTF-2L055-S	G003
CSTR-4L100	G003
CSW-...	G016
CSW-0T	G016
CSX20	D026, G016
CSY-...	D026, D027, G016
CT-100	C068, C104, C127
CT-105	C068, C104, C127
CT-110	C068, C104, C127, C128, C133
CT-86	C068, C104, C127
CTBF...	C068
CTBN**-*32	C122
CTBR/L...	C123
CTBS**-*32	C122
CTBU**-*-*-*CHP	C133
CTBU...	C068, C104, C127
CTBU16-32-U-CHP	C128
CTC-*R/L	G014
CTCPR/L2525M3	B260

User's Guide - Alphanumeric Index

Designation	Page
CTD...	C120
CTEFR/L...	C063
CTER/L...	C060, C061
CTER/L**-15A	C078
CTFNR/L...	B258
CTFPR/L...	B259
CTFR/L...	C072
CTFVR/L...	C073
CTGNR/L...	B256
CTGPR/L...	B258
CTH...	C121
CTIFR/L...	C077
CTIR/L...	C070
CTN...	C124
CTR/L...	C124
CTS-M6	G005
CTSR/L...	C123
CTWR/L...	C120
CU-CW-CHP	B203, B218, B220, B222 - B225, G021
CU-D-CHP	B205, B219, B223, B226, G021
CU-V-CHP	G021
CV34-A	G011
CVVNN16M35-RD	B272
CX710	A005
D	
D**-D**R	D211
DCET**MFRN-JSP	B121
DCET**MFR/L-JPP	B120
DCET**MFR/L-JRP	B121
DCGT...	B119
DCGT**-01	B116
DCGT**-AL	B119
DCGT**F-01	B116
DCGT**FN-JS	B120
DCGT**FR/L-J10	B121
DCGT**N-JS	B120
DCGT**R/L	B119
DCGT**R/L-W10	B118
DCGT**R/L-W15	B118
DCGT**R-J10	B121
DCGW...	B119
DCGW**-DIA	B179
DCLNR/L...	B233
DCMT**-23	B117
DCMT**-24	B117
DCMT**-CM	B118
DCMT**-DIA	B179
DCMT**-PF	B116
DCMT**-PM	B118
DCMT**-PS	B117
DCMT**-PSF	B116
DCMT**-PSS	B117
DCMW...	B119
DCMW**TN	D164, D217
DCPM-...	G014

Designation	Page
DDJNR/L...	B234
DDQNR/L...	B237
DGE...	C086
DGG...	C087
DGIM2-020	C089
DGIS2-020	C089
DGM...	C083
DGS...	C084
DLCL...	G017
DLCS...	G007
DMP...	E006 - E016, E018 - E020
DMX**M	E058, E059
DMX**S	E056, E057
DMXU**VM	E055
DMXU**VS	E054
DNGA...	B070
DNGA**-DIA	B178
DNGA**-QBN	B169
DNGD...	B071
DNGG**-01	B063
DNGG**FR/LP	B069
DNGG**R/L	B068
DNGN...	B071
DNMA...	B070
DNMG...	B067
DNMG**-27	B067
DNMG**-28	B068
DNMG**-33	B068
DNMG**-37	B068
DNMG**-38	B068
DNMG**-AM	B066
DNMG**-AS	B065
DNMG**-CB	B065
DNMG**-CF	B064
DNMG**-CH	B070
DNMG**-CM	B069
DNMG**-DM	B067
DNMG**-FW	B063
DNMG**-HMM	B069
DNMG**-HRF	B064
DNMG**-HRM	B069
DNMG**L/R-S	B069
DNMG**-NM	B066
DNMG**-NS	B065
DNMG**-SA	B069
DNMG**-SF	B064
DNMG**-SH	B070
DNMG**-SM	B068
DNMG**-SS	B066
DNMG**-SW	B065
DNMG**-TF	B063
DNMG**-TH	B070
DNMG**-THS	B070
DNMG**-TM	B066
DNMG**TN11	B064
DNMG**TN17	B064
DNMG**TN28	B068
DNMG**-TQ	B067

Designation	Page
DNMG**-TS	B065
DNMG**-TSF	B063
DNMG**-ZF	B063
DNMG**-ZM	B067
DNMG**E-FW	B063
DNMG**E-SM	B068
DNMG**E-SS	B066
DNMG**E-SW	B065
DNMG**E-TM	B066
DNMG**E-TSF	B063
DNMG**E-ZF	B063
DNMG**E-ZM	B067
DNMM**-DIA	B178
DNMX...	B071
DPCW11T3ZFR	D217
DPD09...	D117
DPIS...	G021
DRGNR/L...	B237
DS-...	G006
DS1100	A004
DS1200	A004
DSBNR/L...	B235
DSDNN...	B235
DSKNR/L...	B236
DSM...	E050 - E052
DSM-CP...	E053
DSSNR/L...	B235
DSW**-*-DE3	E030, E031
DSW**-*-DE5	E032, E033
DSW**-*-DI5	E034, E035
DSW**-*-DI8	E036
DSX**F03	E044, E045
DSX**F05	E046, E047
DSX**F08	E048, E049
DSXU**F03	E042
DSXU**F05	E042
DSXU**F08	E043
DTA...	C090
DTE...	C086, C087
DTF...	C088
DTFNR/L...	B236
DTGNR/L...	B234
DTI...	C088
DTIU...	C090
DTR...	C089, C090
DTS*-...	G007
DTX...	C087
DWLNR/L...	B233
DX110	A007
DX120	A007
DX140	A007
DX160	A007
DX180	A007
DXGU**MFR/LE-JRP	B122, B199, B291
DXGU**MFR/L-JSS	B122, B199, B291
DXGU**MFR/L-JTS	B122, B199, B291
DXGU**MR/L-JSS	B123, B200, B292
DXGU**MR/L-JTS	B122, B199, B291
DXGU**R/L-SS	B123, B200, B292

User's Guide - Alphanumeric Index

Designation	Page
DXGU**R/L-TS	B123, B200, B292
E	
E**-SCLCR/L...	B301
E**-SCLCR/L**-D...	B299
E**-SCLPR/L**-D...	B303, B304
E**-SDQCR/L**-D...	B316
E**-SDUCR/L**-D...	B313
E**-SDXXR/L**-D...	B288
E**-SDZCR/L**-D...	B319
E**-SEXPR/L**-D...	B302
E**-SEZPR/L**-D...	B321
E**-STFCR/L**-D...	B308
E**-STFPR/L**-D...	B309
E**-STUPR/L**-D...	B310, B311
E**-SVQBR/L**-D...	B317
E**-SVQCR/L**-D...	B318
E**-SVUBR/L**-D...	B314
E**-SVUCR/L**-D...	B315
E**-SWLXR/L**-D...	B288
E**-SWUBR/L**-D...	B312
E**-SYQBR/L**-D...	B329
E**-SYUBR/L**-D...	B329
EA-...	G021
EAW13...	D110
EBD...	D166
EBFU...	D142
EBP...	D164
ECC31...	D206
ECP44...	D208
ECW-456EF	C126 - C131, G024
ECW-456I	C129, C132, G024
EDKW53ZTR	D217
EDPD09...	D117
EEN09...	D107
EFE12**RU	D114
EFPR/L...	C132
EGM4-030	C135
EGP...	C127
EGP**-CHP	C128
ELD05...	D069
ELS11...	D059
ELSC...	G010
ELSD...	G010
ELSD317BR/L	G010
ELSS...	G009
ELST...	G008
ELST**BR/L	G008
EM10	A007
ENEQ**TN-T	D218
EPA06...	D038
EPA10...	D040
EPA15...	D042
EPAV06...	D050
EPD05...	D069
EPGT**-JS	B125
EPGT**F-JS	B125
EPGT**FL-J08	B125

Designation	Page
EPGT**FR/L-W08	B124
EPGT**L-J08	B125
EPGT**R/L-W08	B124
EPGW**-DIA	B180
EPH...	D085
EPM11...	D079
EPO07...	D054
EPO18...	D066
EPQ11...	D077
EPS11...	D058
EPS17...	D089
EPTC16...	D047
EPTN12...	D034
EPV16...	D081
EPW13...	D073
ER-...	F099
ER**CF*-...	F097
ER**ODP...	F113
ER**SEAL**JET2	F103
ER**SEAL**...	F102
ER**SPR**...	F100
ER**SPR**AA	F041, F101
ER**SRK...	F041, F114
ER**SRK**JET2	F115
ERC**R...	D156
ERD**R...	D160
ERP**R...	D150
ESDNR/L...	B254
ESSNR/L...	B255
ETANR...	B253
ETENN...	B254
ETER/L...	C126
ETFR/L...	C130
ETFR**-CHP	C131
ETGNR/L...	B253
ETIR/L...	C129
ETX...	C135
ETXNR/L...	B255
EVH**R...	D200
EVX...	D203
EWD**RU	D162
EXCF*-...	F097
EXH06...	D004
EXH07...	D004
EXH09...	D004
EXLN04...	D016
EXN03...	D008
EXN06...	D013
EXP05...	D027
EXP06...	D027
EXP09...	D027
EXTRACTOR SC COLLETS	F030, F121
EZ...	E086
EZ104	F006, F008, F010 - F012
EZ83	F007

Designation	Page
F	
F	A007
FCL...	G017
FCS...	G005
FDC-U**L	E062
FDC**L	E064
FDC**S	E063
FDCU**S	E062
FDS...	E060
FDS-...	G006
FDS-8SSST	G027
FDS-8ST	G006
FDS-8ST-18	G006, G027
FLASR/L...	C021
FLER/L...	C022
FLER/LT-**D	C023
FLEX**R/L	C119
FLG**R/L	C027
FLG**R/L-CB	C026
FLG-3M**R/L-CB	C026
FLGD**R/L	C029
FLGD**R/L-CB	C029
FLGP**R/L	C027
FLGT**R/L	C030
FLR**R/L	C028
FLR**R/L-CB	C028
FLRD**R/L	C029
FLRP**R/L	C028
FLRT**R/L	C030
FLSR/L...	C021
FLSR/LT-**D	C022
FLT-3R/L...	C030
FPGN...	C139
FPGR...	C138
FSHM**...	G005
FSSA1102	D109, D110, G009
FSSP1102	D072, D073, G009
FW**R/L	G027
FW304R/L-D	G027
FW-304R-T	D117
FW-305	G028
FW325R/L-D	G028
FX105	A005
G	
G16EL/IR...	G011
G16ER/IL...	G011
G1F	A007
G2	A007
GBR/L32...	C041
GBR/L43**R	C042
GBR/L43...	C041
GDGT**PDFR-AJ	D218
GDMT**PDPR-MJ	D218
GE...	C114
GE**-AL	C114
GE**R/L	C114
GE20	B404

User's Guide - Alphanumeric Index

Designation	Page
GE20-AL	B404
GF...	C114
GFIMT**ER...	F093
GFIST**ER...	F093
GH110	A004
GH130	A004
GH330	A004
GH730	A004
GIR...	C035
GLR/L...	C043
GN...	C114
GOR/L...	C043
GP06...	E109
GR...	C114
GT...	C114
GT720	A005
GT9530	A005
GTGN-16...	C045
GTI CAT** ER...	F085
GTIER**ST...	F022
GX-**R/LE	C036
GX-**R/LF	C038
GX-**R/LI	C036
GX-**REU	C036
GX-**RIU	C036
GX16-1DT	G012
GX22-1DT	G012
GXE16-...	G012
GXE16-**DT	G012
GXE22-**DT	B442, G012
GXE22-*DT	B442
GXN16-...	G012
GXN16-**DT	G012
GXN22-**DT	B442, G012
GXN22-*DT	B442
GYRODIN69880**ER...	F092
GYROST**ER...	F092
H	
H410-1	B466
HBFM...	D143
HEHN532FN	D218
HFWX04**M...	D148
HNGD...	B105
HPA06**M...	D039
HPA10**M...	D040
HPAV06...	D050
HPKN532FN	D219
HPO07**M	D055
HPO11...	D060
HRP**R**M...	D151
HS**-FLER3W	C024
HS**-LNFR-53	B464
HS**-LNFR-54API	B466
HS**-MTHOR...	B468
HSK A 100 FM 2-1/2X2.875	F064
HSK**A-C*...	F032
HSKA**CF4-S	F066

Designation	Page
HSKA**EM...	F053
HSKA**ER...	F046
HSKA**ER**BIN	F048
HSKA**ER**M	F045
HSKA**ER**SHORT	F048
HSKA**ER32CLICK-IN	F066
HSKA**HYDRO**150 - 200	F051
HSKA**HYDRO**80 - 125	F050
HSKA**MAXIN...	F049
HSKA**MAXIN**BIN	F049
HSKA**MN...	F068
HSKA**MT...	F065
HSKA**ODP...	F067
HSKA**SEM...	F062
HSKA**SEMC...	F064
HSKA**SRK...	F062
HSKA**SRKIN...	F054
HSKE**ER...	F044
HSKE**ER**BIN	F047
HSKE**ODP...	F067
HSKE**SEM...	F061
HSKE**SRK...	F058
HSKFM**ER...	F047
HSKFM**SEM...	F063
HSKFM**SRKIN...	F056
HSRNR/L...	B260
H-TB	G024
H-TB2W	G024
H-TBS	G024
HW2.0/5RED	G023
HWD07**R**M...	D162
HXLN04...	D017
HXN03...	D009
I	
IND SHRINK IN UNIT USA	F116
IND SHRINK START UNIT USA	F116
INDER11TOOLADAPTER	F123
IP-**D	G024
IP-20T	G024
IP-6DB	G024
IP-6F	G023
J	
J10ER/L**B	B157, B383
J10ER/L**BF	B157, B383
J740	A004
J9530	A005
JBBR...	B388
JBBS...	B391
JBBS**-L100C	B392
JBCR...	B387
JBFR/L...	B390
JBGR/L...	B389
JBIR...	B388
JBPR...	B387
JBRR...	B391

Designation	Page
JBSR07200200-D060	B390
JBTR/L...	B386
JBUR...	B387
JCCN200F...	B402, C016
JCCR/L200F...	B402, C016
JCCWSR/L...	B402, C016
JCGN200F...	B403, C017
JCGSSR/L...	B404, C102
JCGWSR/L...	B403, C017
JCP-...	G015
JCP-3N	G015
JCTER/L...	C062
JDS-...	G006
JM10	A004
JPDJ2XR/L...	B192
JPVJ2XR/L...	B194
JPWL2XR/L...	B190
JS**K-SDUCL...	B369
JS**K-TBL3	B381
JS**K-TGL3	B399, C018
JS**K-TTL3	B406, B460
JS**-SDUXL07	B196
JS**-STCL18	B458
JS**-STCR/L18	C056
JS**-SVUXL09	B197
JS**X-STCR/L27	C049
JS08H-SEXPR...	B305
JSCACL...	B364
JSCGCR/L...	B365
JSCL2CR/L...	B362
JSCLCR**-F15	B363
JSCLCR/L...	B363
JSDFCR/L...	B369
JSDJ2CR/L...	B365
JSDJ2CR/L**CHP	B228, B367
JSDJ2XR/L...	B192
JSDJ2XR/L**CHP	B193, B227
JSDJCR**-F15	B366
JSDJCR/L...	B367
JSDJXR**-F...	B193
JSDN3CR/L...	B368
JSDNCN...	B368
JSEGR/L...	B383
JSTACR/L...	B370
JSTBR/L...	B381
JSTGR/L...	B399, C018
JSTTR/L...	B406, B460
JSVABR/L...	B372
JSVGR/L...	B397, C014
JSVJ2BR/L...	B371
JSVJ2BR/L**CHP	B229, B372
JSVJ2XR/L**CHP	B195, B228
JSVJ2XR/L...	B194
JSVJBR**-F15	B373
JSVJBR/L...	B371
JSVJXR**-F...	B195
JSVL2PR/L...	B375
JSVNBN...	B374
JSVP2PR/L...	B375

User's Guide - Alphanumeric Index

Designation	Page
SATZ-M8X1-M3	C066, C076, F006, F007, F014
SC...	F019
SC**HYDRO...	F111
SC**SEAL...	F028, F109
SC**SPR...	F029, F108
SCA**...	F031
SCLCR/L...	B261
SCMT**23	B129, D166, D227
SCMT**24	B129
SCMT**CM	B129
SCMT**PM	B129
SCMT**PS	B129
S-CU-CHP	B191, B193, B195, B227, B228, B229, B347, B367, B372, G021
SD06-A3	G005
SD08-98	G005
SD2	B468
SD3	B468
SDCN1504ZDSR	D227
SDCN42HTR	D228
SDCN42Z...	D122, D228
SDCN42ZFN-DIA	D122, D228
SDCN53HTR	D229
SDCN53ZTN	D125, D229
SDEN1504ZDSR	D227
SDEN42EFTR24	D228
SDEN42Z...	D122, D228
SDEN53Z...	D125, D229
SDGT1204AFFN-AJ	D230
SDGT1204AFTN-MJ	D230
SDGT1204PDFR-AJ	D230
SDGT1204PDTR-MJ	D230
SDHT050204FN-AJ	D070, D229
SDJCR/L...	B261
SDKN42EF...	D228
SDKN42HTR	D228
SDKN42Z...	D122, D228
SDKN53HTR	D229
SDKN53Z...	D125, D229
SDKR1203AETN-MJ	D122, D228
SDKR42ZPN-MS	D122, D228
SDKR42ZSR-MJ	D122, D228
SDKR53ZSR-MJ	D125, D229
SDMR1203AETN-MJ	D122, D228
SDMT050204PN-MJ	D070, D229
SDMT1204AFPV-MJ	D230
SDMT1204AFPV-ML	D230
SDMT1204AFPV-MS	D230
SDMT1204AFTN-MJ	D230
SDMT1204PDPR-ML	D230
SDMT1204PDPR-MS	D230
SDMT1204PDSR-MJ	D230
SDMT1204PDTR-MJ	D230
SDMW090308TN	D231
SDMW120408TN	D231
SDNCN...	B262

Designation	Page
SDNN1504ZDSR	D227
SDQCR/L...	B267
SE*N1504AG...	D231
SE*N42ZFR	D233
SECN1203AGFN	D231
SECN422FN	D232
SECN422FN-DIA	D232
SECN422TN	D232
SECN42EFTRCR	D233
SECN42ZFR-DIA	D233
SEEN1203...	D231
SEEN1203AFTNCR-14	D232
SEEN1203AG...	D231
SEEN422FN	D232
SEEN422TN	D232
SEEN42EFTRCR	D233
SEGT12X4ZEFR-AJ	D115, D234
SEGW12X4ZEFR	D115, D234
SEGW12X4ZEFR-BD	D115, D234
SEGW12X4ZEFR-D	D115, D234
SEGW12X4ZEFR-WD	D115, D234
SEGW12X4ZEPR	D115, D234
SEKN1203AG...	D231
SEKN1504...	D231
SEKN42AFFN	D232
SEKN42AFTN	D232
SEKN42AFTN16	D232
SEKN42EFFR	D233
SEKN42EFTR	D233
SEKR1203AFPV-MS	D232
SEKR1203AFTN-MJ	D232
SEKR1203AGPN-MS	D231
SEKR1203AGSR-MJ	D231
SEKR1504AFSR-MJ	D234
SEKR1504AGSR-MJ	D231
SEKR42AFSR-MJ	D232
SEM22CF4C	F097
SEMR1203AFTN-MJ	D232
SET T-15/5	G023
SETER**SEAL...	F104
SETER**SEAL**JET2	F105
SETER**SEAL*EM	F105
SETER**SEAL*EMJET2	F106
SETER**SPR...	F104
SETER**SPR**AA	F104
SETER**SPR*EM	F105
SETER**SRK*USA	F117
SETSC**SEAL...	F113
SETSC**SPR...	F113
SF*N42ZFN	D235
SF*N53ZFN	D235
SF60	B470
SF80	B470
SF85	B470
SFCN42ZFN-DIA	D235
SFCN53ZFN-DIA	D235
SGC340	C128
SGM...	C083
SGN...	B176, C091

Designation	Page
SGS...	C085
SGSR/L151	G013
SGTR/L...	C042
SH725	A004
SH730	A004
SHCM*-...	G005
SHM**x**x**-C	G006
SHRINKIN UNIT V2 USA	F116
SI-CLHOR-40M6	B471
SIR 1250 S16	B436
SIR**16B	B436
SL**IN	E024, E025, E076 - E080
SL-*R/L	G013
SLJ...	E112
SLLV-...	G017
SL-PI-2	G018
SM**-L**C...	D147, F094
SM**-L**-CF4	F094
SM*x*x...	G004
SM-00	G022
SM40-143-H0	G003
SMP...	E026, E027
SN**56FTR	D235
SNCN43Z...	D236
SNEN12**Z...	D236
SNGA...	B080
SNGA**-DIA	B178
SNGA**-QBN	B169
SNGD...	B081
SNGG**-01	B073
SNGG**FR/LP	B077
SNGG**R/L-B	B073
SNGG**R/L-C	B073
SNGG**R/L-D	B073
SNGN...	B081
SNGN**-DIA	B178
SNGR/L...	C031
SNGU1307ANEN-MH	D099, D237
SNGU1307ANEN-MJ	D099, D237
SNGU1307ANEN-W	D099, D237
SNGU1307C14ANEN-MJ	D099, D237
SNGX...	B081
SNHU1706ANFN-W	D104, D236
SNHU1706ANPR-MJ	D104, D236
SNHU1706ANTR-ML	D104, D236
SNKF43Z...	D236
SNKN43ZTN	D236
SNMA...	B080
SNMG...	B076
SNMG**-AS	B075
SNMG**-CF	B074
SNMG**-CH	B079
SNMG**-CM	B077
SNMG**-DM	B076
SNMG**-HMM	B078
SNMG**-HRF	B074
SNMG**-HRM	B077
SNMG**-NS	B075

User's Guide - Alphanumeric Index

Designation	Page
SNMG**R/L-S	B078
SNMG**SA	B078
SNMG**SF	B074
SNMG**SH	B079
SNMG**SM	B077
SNMG**SS	B075
SNMG**TF	B073
SNMG**TH	B078
SNMG**THS	B078
SNMG**TM	B075
SNMG**TN11	B074
SNMG**TN17	B074
SNMG**TN27	B076
SNMG**TN37	B077
SNMG**TS	B075
SNMG**TSF	B073
SNMG**ZM	B076
SNMM**TRS	B079
SNMM**TU	B079
SNMM**TUS	B079
SNMN...	B081
SNMN**TN	B081
SNMN1204**TN	D237
SNMU1307ANEN-MJ	D099, D237
SNMU1706ANPR-MJ	D104, D236
SNMU1706ANTR-ML	D104, D236
SNR**06...	B434
SNR/L...	B435
SNR/L**11, 16, 22...	B435
SP*N42...	D238
SP-...	G018
SP-16-L14	G020
SP-2.5	G020
SP913	G020
SPCN42...	D238
SPCN53S...	D239
SPEN42...	D238
SPEN423...	D238
SPG...	B132
SPG**QBN	B174
SPGA...	B131
SPGM**L	B131
SPGN...	B132
SPGN**T...	C139
SPGN**-DIA	B179
SPGN**-QBN	B174
SPGN120312TN	D238
SPGN120412TN	D239
SPGR**L	B132
SPGT**L-W20	B130
SPGT**R/L-W15	B130
SPGW...	B131
SPHA431FNW	D239
SPHA435FNW	D239
SPKN42...	D238
SPKN53S...	D239
SPKR42SSR-MJ	D238
SPKR53SSR-MJ	D239
SPMA42...	D208, D240

Designation	Page
SPMM**ERD	D210, D240, E094
SPMN...	B132
SPMP...	D210, D240, E094
SPMR**23	B132
SPMR**CM	B132
SPMR1605PPPR-ML	D240
SPMR1605PPTR-MH	D240
SPMR1605PPTR-MJ	D240
SPMT**23	B130
SPMT**24	B130
SPMT**CM	B131
SPMT**PS	B130
SPMW...	B131
SPU...	B132
SQMU1206ZSR-MJ	D021, D241
SR 114-018-L3.40	G003
SR 5/16-32UNEF_3/8-24UNF	G005
SR PS 118-0273	G005
SR-10400611	G007
SR14-5...	G003
SR14-506	E099, E100, E101, E102, E106
SR14-544/S	E017
SR14-560/S	E099, E100, E101, E102, E106
SR14-571/S	E099, E100, E101, E102, E106
SR14-591	G003
SR16-212-01397	G003
SR16-212-01397L	G003
SR34-5...	G003
SR34-506	E099, E100, E101, E102, E106
SR34-508	E099, E100, E101, E102, E106
SR76-9...	G003
SRACR/L...	B264
SRDCN...	B266
SRDCN**-6F	B269
SRGCR/L...	B265
SRGCR/L**-6F	B269
SRM**DIN1835...	F123
SRM**EMSHORT	F123
SRM10X1.5S	E017
SRM10X10DIN916	E017
SRM3	B203, B205, B218 - B226, G022
SRM4X4 TL360	G022
SRM5X0.8IP20X+ACROLYTE	G003
SRM6X16DIN912-12.9	G005
SRW11	G021
SS100	G006
SS94	B464, B466, B468, C025
SSC...	G010
SSC**-P	G010
SSD32	G010
SSDCN...	B266
SSDPN...	B266

Designation	Page
SSG**R*-...	D128
SSHM*-...	G006
SSM...	D129, D241
SSR32	G011
SSS...	D129, D241
SSS32	G009
SST32	G008
SSV...	G011
ST**ER...	F088
ST**ER**M	F087
ST**ER**MF	F089
ST**ER**MFD	F089
ST**ER**S	F090
ST**SRK...	F090
STACR/L...	B263
STC-11	B463, B464, B465, B466, B467, B468
STC-4	B470
STC-8	B471
STC-9	B468
STCR/L**18	B457
STCR/L**-18	C055
STCR/L**-27	C048
STCR/L16-27-CHP	C048
STN62R/L	G013
STVOR...	B468
SVHCR/L...	B268
SVJCR/L...	B262
SVQCR/L...	B267
SVVCN...	B263
SW**-**	D130
SW...	G022
SW99	G018
SWG1304PDFR-AJ	D074, D243
SWG1304PDPR-MJ	D074, D243
SWG13T3AFFR-AJ	D111, D242
SWG13T3AFPR-MJ	D111, D242
SWMT1304PDER-ML	D074, D243
SWMT1304PDPR-MJ	D074, D243
SWMT1304PDPR-MS	D074, D243
SWMT13T3AFER-ML	D111, D242
SWMT13T3AFPR-HJ	D111, D242
SWMT13T3AFPR-MJ	D111, D242
SWMT13T3AFPR-MS	D111, D242
SWMT1506ZER-MJ	D024, D243
SWMW13T3AFTR	D111, D242
SYHBR/L...	B232
SYIBN...	B232
SYJBR/L...	B231
SYQBR/L...	B231
T	
T**-*/5	G023
T**-D	G024
T**-F	G023
T**-L	G023
T**-PCLNR...	B336
T**-PDUNR...	B338

User's Guide - Alphanumeric Index

Designation	Page
T**-PTUNR...	B339
T**-SCLGR/L...	B330
T**-SCLPR/L...	B330
T**-SDQCR/L...	B333
T**-STUPR/L...	B331
T**-SVQBR11C	B334
T**-SVQCR16C	B334
T**-SVUBR11C	B332
T**-SVUCR16C	B332
T**-T	G024
T**-TORX	G023
T**-R...	D211, D244
T-10/5	E099, E100, E101, E102, E106
T1115	A002
T1215	A002
T2QP-CNGA...	B165
T3130	A002
T313V	A002
T3225	A002
T3QP-TNGA...	B166
T5105	A002
T5115	A002
T5125	A002
T515	A002
T6120	A002
T6130	A002
T9105	A002
T9115	A002
T9125	A002
T9135	A002
TAN07...	D101
TAN07**W	D103
TASN13...	D098
TAW13...	D109
TBGN**-15-QBN	B174
TC-...	G014
TC-190	B467, B468
TC-250	B463, B464, B465, B466, B467, B468
TC-311	B470, B471
TCB-...	D209
TCGT**-01	B133
TCGT**-AL	B135
TCGT**F-01	B133
TCGT**FN-JS	B136
TCGT**FR/L-J08	B136
TCGT**FR/L-J10	B137
TCGT**L-W15	B134
TCGT**N-JS	B136
TCGT**R	B136
TCGT**R/L-J10	B137
TCGT**-SS	B135
TCGT160608PDER-MJ	D048, D244
TCM27...	C052, C053
TCMT**-23	B134
TCMT**-24	B134
TCMT**-CM	B135
TCMT**-DIA	B179

Designation	Page
TCMT**-PM	B135
TCMT**-PS	B134
TCMT**-PSF	B133
TCMT**-PSS	B133
TCMT160620PDER-NMJ	D048, D244
TCNR...	B437
TCP18R/L**F...	C056
TCP18R/L...	C057
TCS27...	C050, C051
TCS27**R/L	C051
TCT18R/L...	B459, C058
TDBU**-**-2.5	E088, E091
TDMN**FN	D244
TDMN**TN	D244
TDSCA**-...	E088
TDSU**-2	E068
TDSU**-3	E069
TDSU**F**-2	E068
TDSU**F**-3	E069
TDSU**F**-4	E070
TDXCA**-...	E091
TDXCF...	E074, E084
TDXCF**L...	E074, E084
TDXU**FS**-2	E076
TDXU**FS**-3	E077
TDXU**FS**-4	E078
TDXU**FS**-5	E079
TECN32...	D245
TECN43...	D092, D245
TEEN32...	D245
TEEN43...	D092, D245
TEKR1603PEPR-MS	D245
TEKR2204PEPR-MS	D092, D245
TEN09...	D106
TESTBARHYDRO...	F112
TF-...	G014
TF1207	B470
TF-18*	C021
TF8132-E	B470
TFE12**RU	D114
TGTSR/L...	C039
TGTTR/L...	C040
TH03	A007
TH10	A007
TID**-1.5	E006, E007
TID**-12	E014
TID**-3	E008, E009
TID**-5	E010, E011
TID**-8	E012, E013
TIDC**-3	E015
TIDC**-5	E016
TIDCF**-W32	E017
TIDCF**-WU**-**-...	E017
TISU**-3	E024
TISU**-5	E025
TJS**C...	F039
TJS**-CAT...	F040
TJS**ER32...	F038
TJS**HKA63...	F038

Designation	Page
TJS**ST...	F039
TJSTSDDISPLAY	F040
TLA10...	D041
TLA15**-**M	D042
TLA15**-**S	D043
TLANR/L**-12	B276
TLBNR/L24-24	B277
TLFNR/L...	B277
TLM11...	D080
TLS11...	D059
TMBA-0.**H	G007
TMBA-0.750S.375H	G007
TMBA-M**H	G007
TMBA-M...	G007
TMD44**RB-U	D121
TMD44**RI-U	D120
TMD54**RI-U	D124
TNGA**-DIA	B178
TNGA**-QBN	B169
TNGA...	B091
TNGG**-01	B082
TNGG**F-01	B082
TNGG**FR/L-P	B089
TNGG**FR/L-W	B083
TNGG**R/L-A	B082
TNGG**R/L-C	B082
TNGG**R/L-D	B083
TNGG**R/L-P	B089
TNGG**R/L-W	B083
TNGN...	B092
TNGU120708PER-MJ	D035, D246
TNGU120708PER-NMJ	D035, D246
TNKF64ZTR	D246
TNMA...	B091
TNMA 43 **RD EXT	B469
TNMA 43 **RD INT	B469
TNMA 54 5B** EXT-FC	B469
TNMA 54 5B** INT-FC	B469
TNMA**NT**PEXT-PT	B469
TNMA**NT**PSTUBE-PT	B469
TNMC 43 **RD EXT	B469
TNMC 43 **RD INT	B469
TNMC 54 5B** EXT-FC	B469
TNMC 54 5B** INT-FC	B469
TNMC**NT**PEXT-PT	B469
TNMC**NT**PSTUBE-PT	B469
TNMG...	B087
TNMG**-AM	B086
TNMG**-AS	B085
TNMG**-CB	B085
TNMG**-CF	B084
TNMG**-CH	B090
TNMG**-CM	B088
TNMG**-DM	B087
TNMG**-FW	B083
TNMG**-HMM	B089
TNMG**-HRF	B084
TNMG**-HRM	B089
TNMG**-NM	B086

User's Guide - Alphanumeric Index

Designation	Page
X	
X407	A005
XCET310404ER	D206, D252
XGR**S-QBN	B176
XGR/L...	C037
XGR/L**-QBN	C037
XHGR**ER-MJ	D085, D254
XHGR**FR-AJ	D086, D254
XHGR090300-45A	E016
XHGR090300-60A	E016
XHGT090300-30A	E016
XHGX090700R-45A	E074, E084
XNR/L...	C038
XPMT**-DG	E081, E092
XPMT**-DJ	E081, E092
XPMT**-DS	E081, E092
XPMT**-DW	E081, E092
XVCT16**R-AJ	D082, D252
XVGT**EC-MJ	D201, D253
XVGT**EP-MJ	D201, D253
XVGT**FC-AJ	D201, D253
XVGT**FP-AJ	D201, D253
XWXPR/L...	B275
XXGT**EC-MJ	D005, D255
XXGT**EP-MJ	D005, D255
XXGT**FC-AJ	D005, D255
XXGT**FP-AJ	D005, D255
XXMU**PR-MJ	D204, D255
Y	
YDEN0905PDFR-BD	D118, D256
YDEN0905PDFR-D	D118, D256
YDEN0905PDFR-WD	D118, D256
YDEN15...	D256
YDEN2405PDFR-BD	D257
YDEN2405PDFR-D	D257
YDEN2405PDFR-WD	D257
YH170	A004
YH180	A004
YNMG**-ZF	B104
YNMG**-ZM	B104
YPEN1505PPTR-Q	D257
YWMT**-ZF	B155
YWMT**-ZM	B155
Z	
ZDCA**TN	D257
ZDMT**-MJ	D166, D258
ZFBM**-MJ	D144, D258
ZFBU**-MJ	D144, D259
ZFRM**-MJ	D145, D258
ZFRU**-MJ	D145, D259
ZNCA**FN...	D260
ZNMM**EN	D260
ZPCW**-QBN	D260
ZPET**-MJ	D164, D260
ZSA**02	G010

MEMO

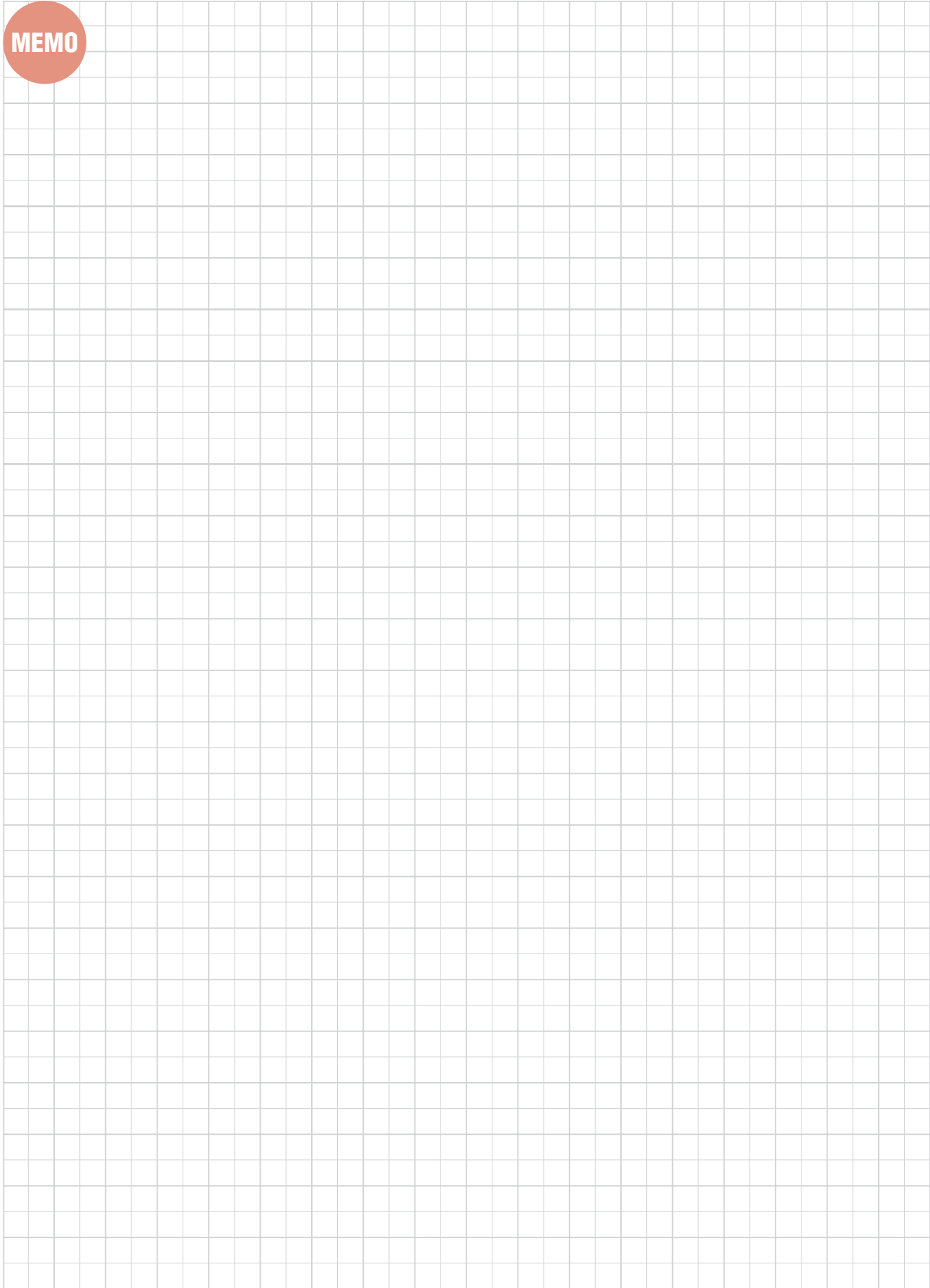

MEMO

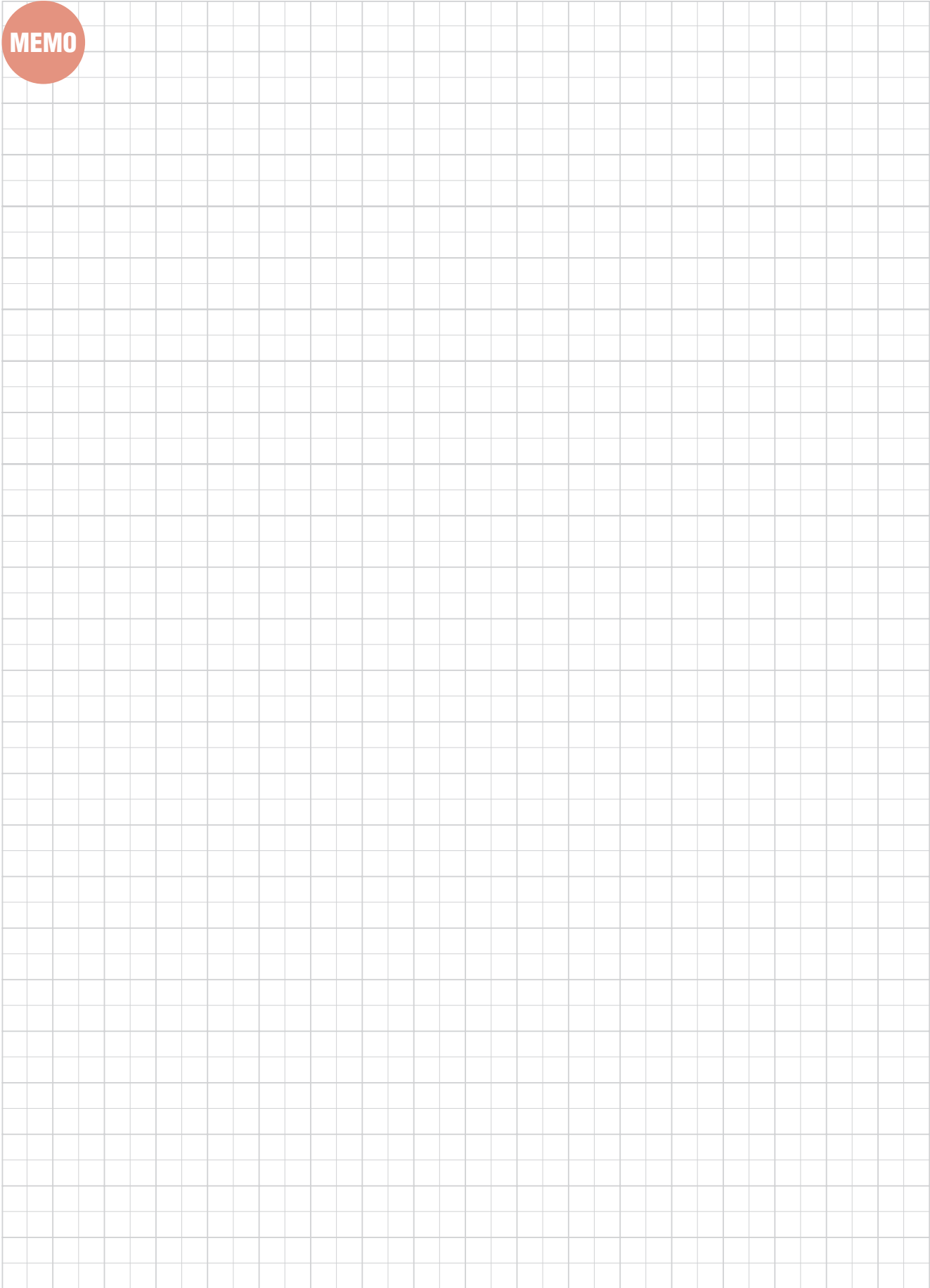

MEMO

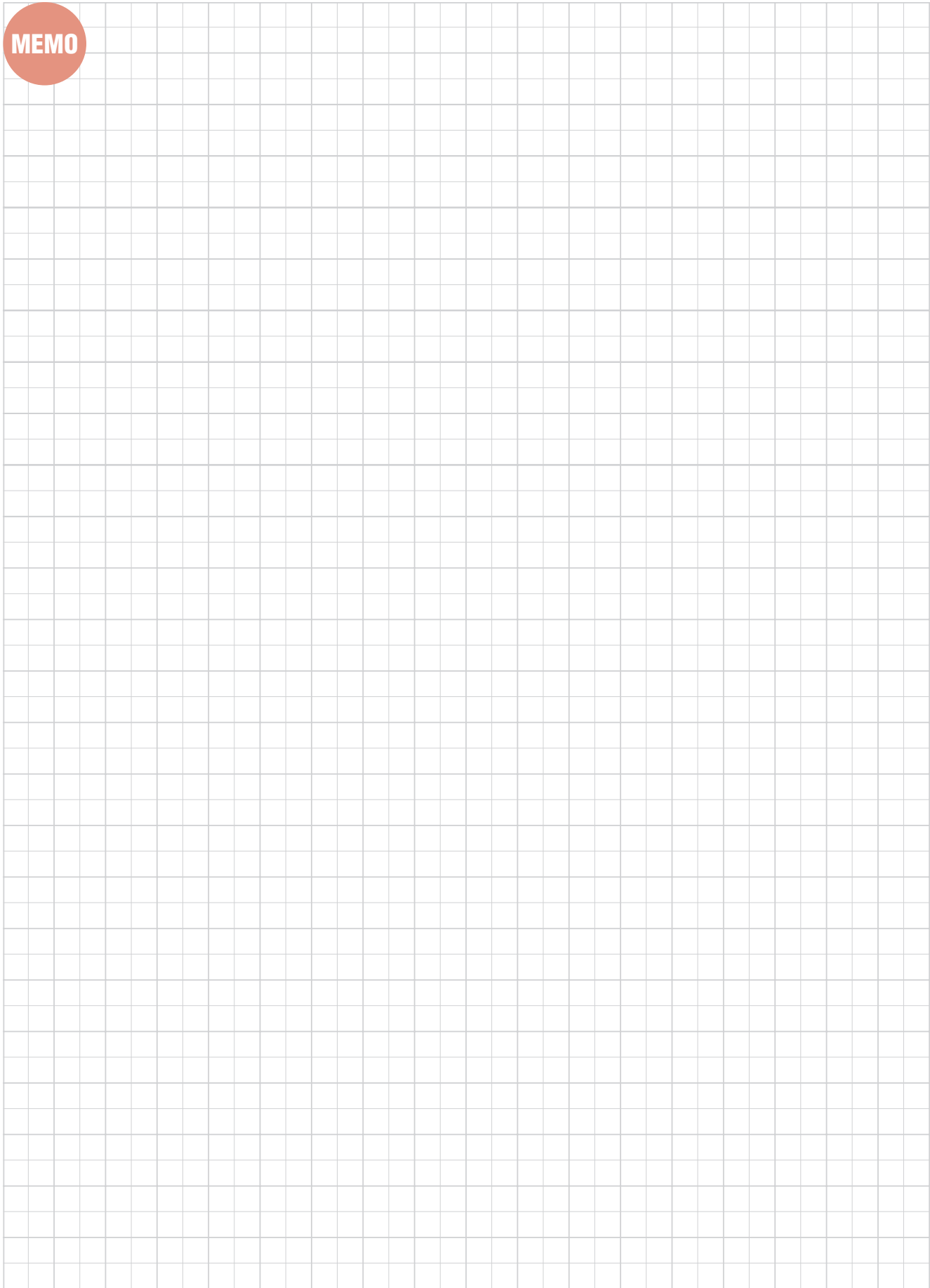

MEMO

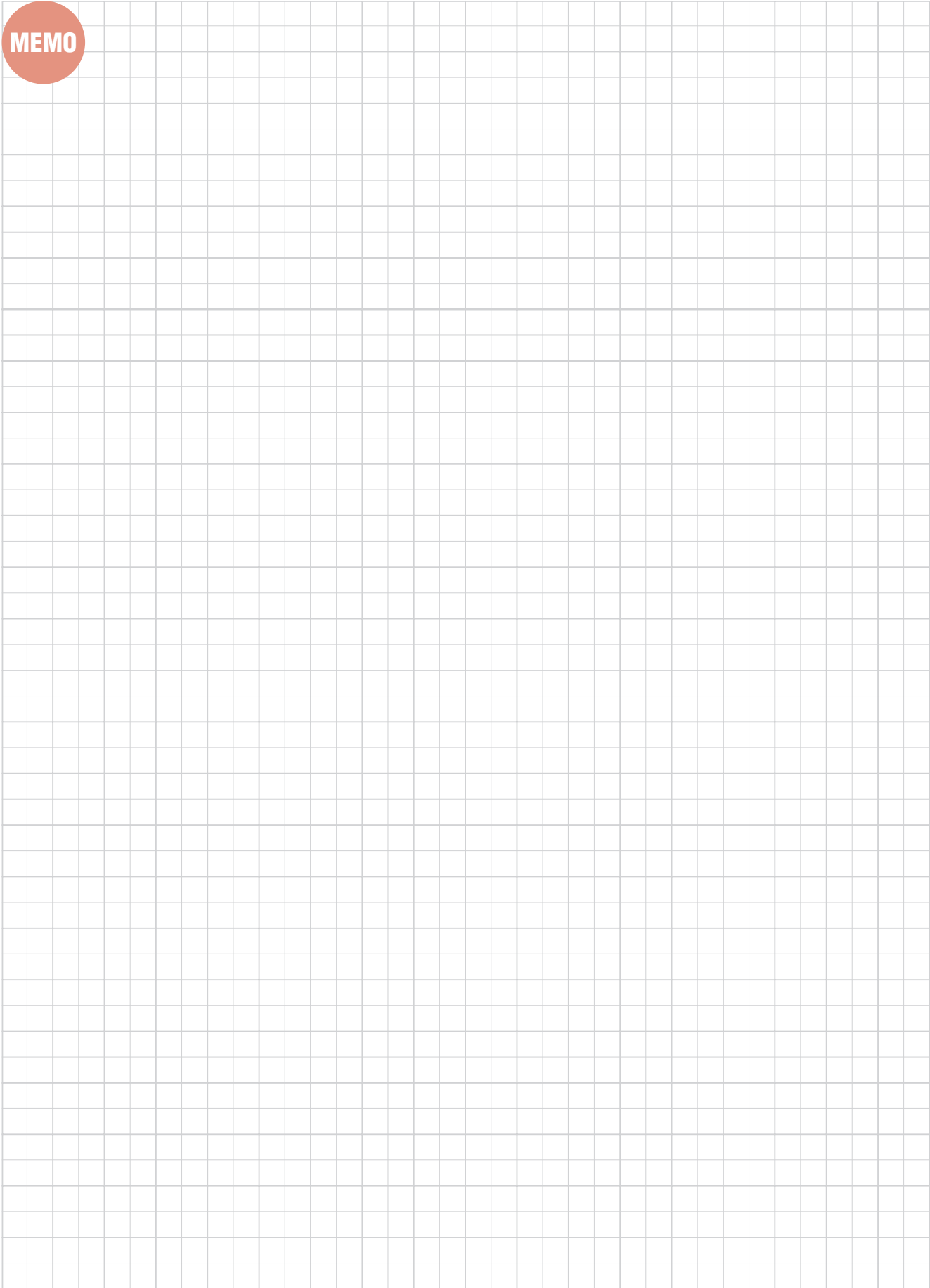

MEMO

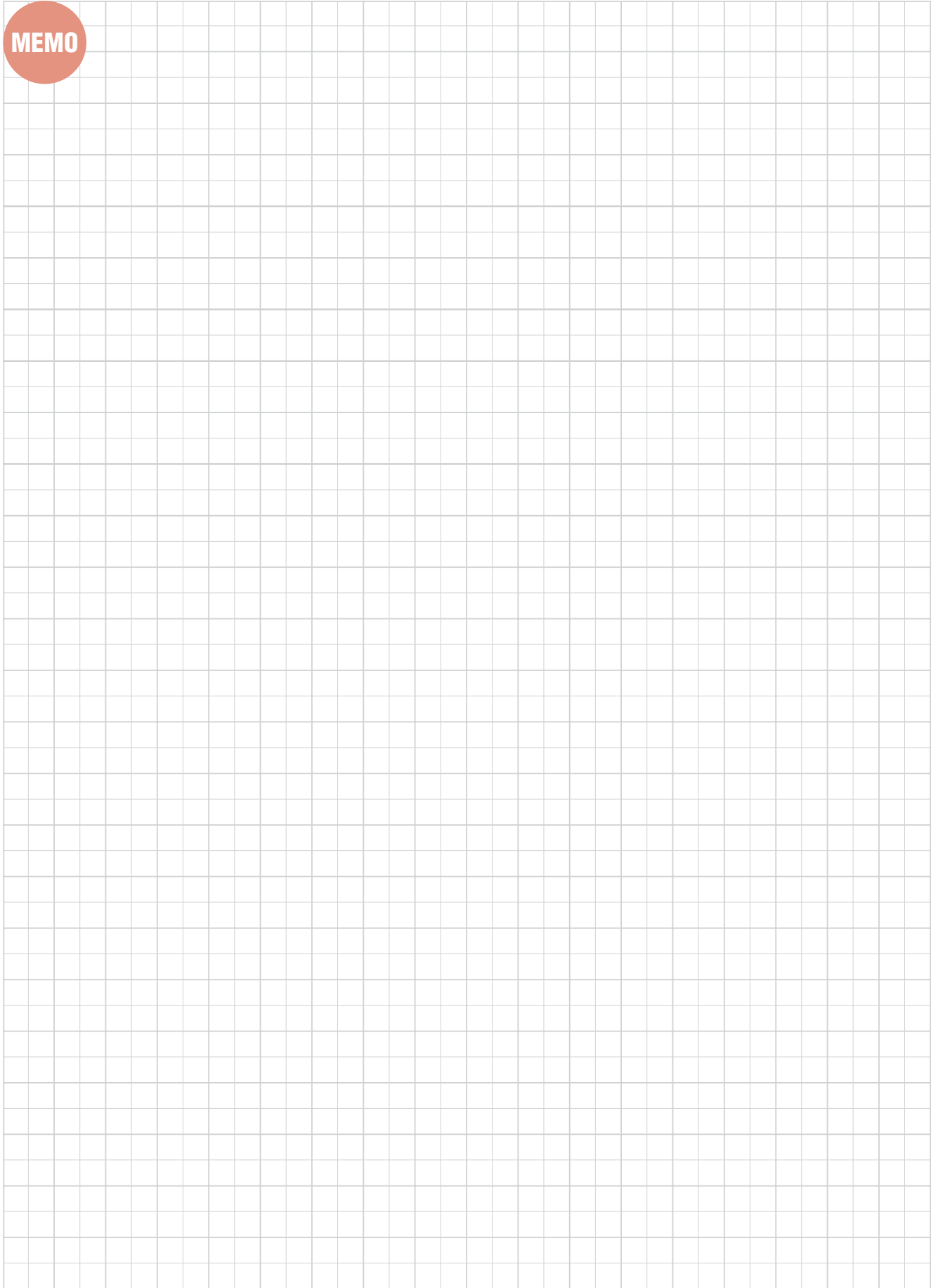

MEMO

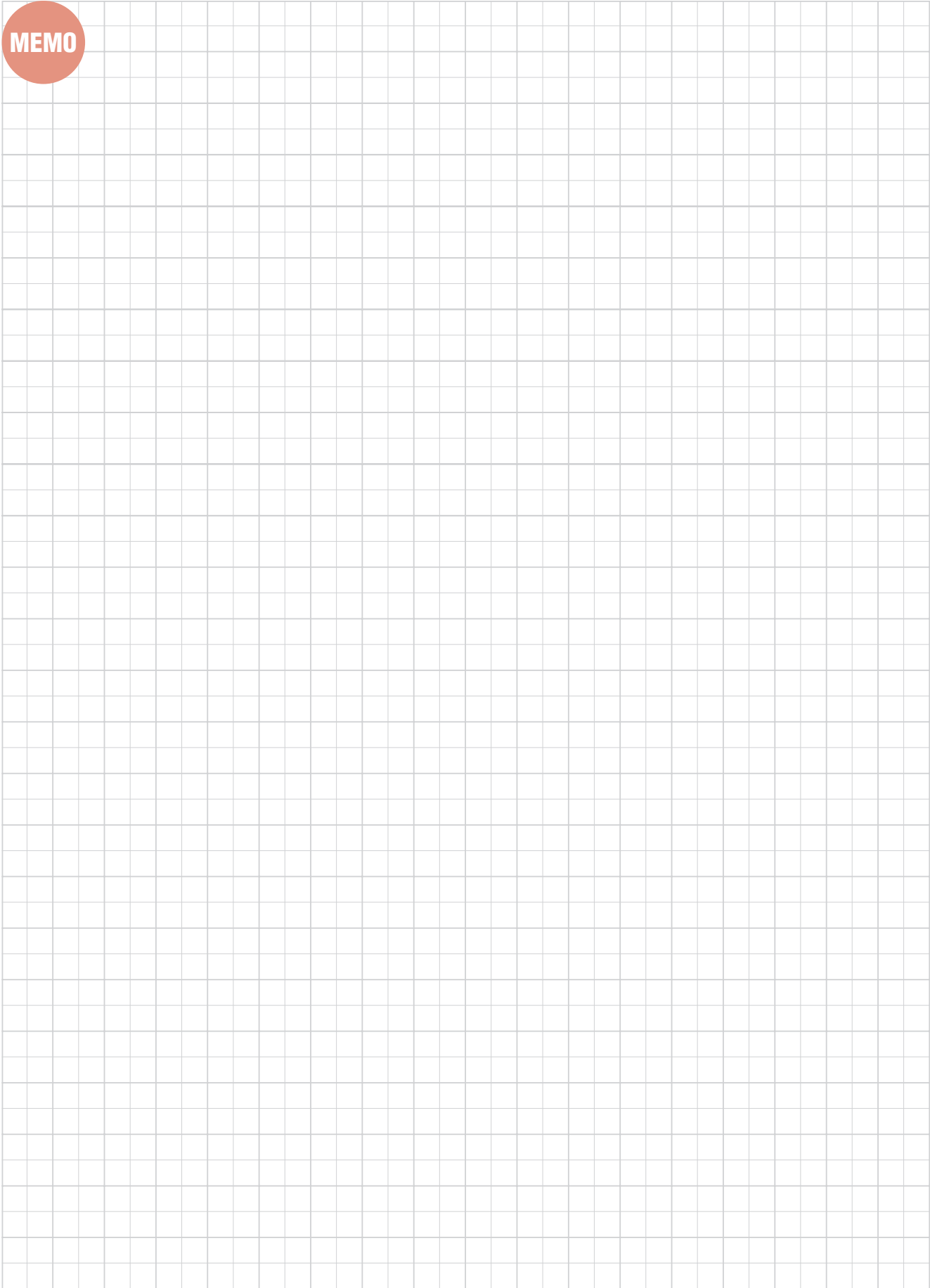

MEMO

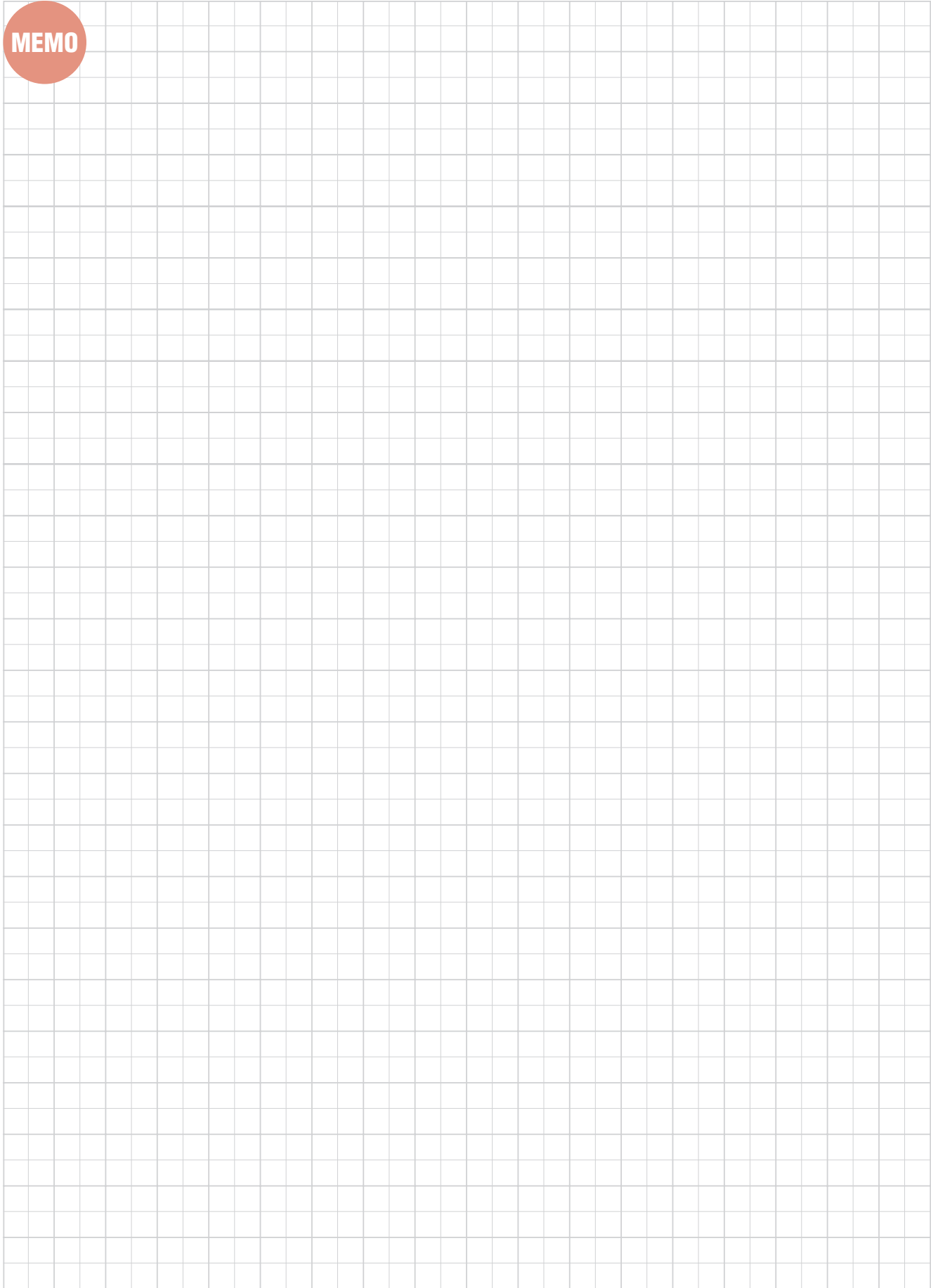

MEMO

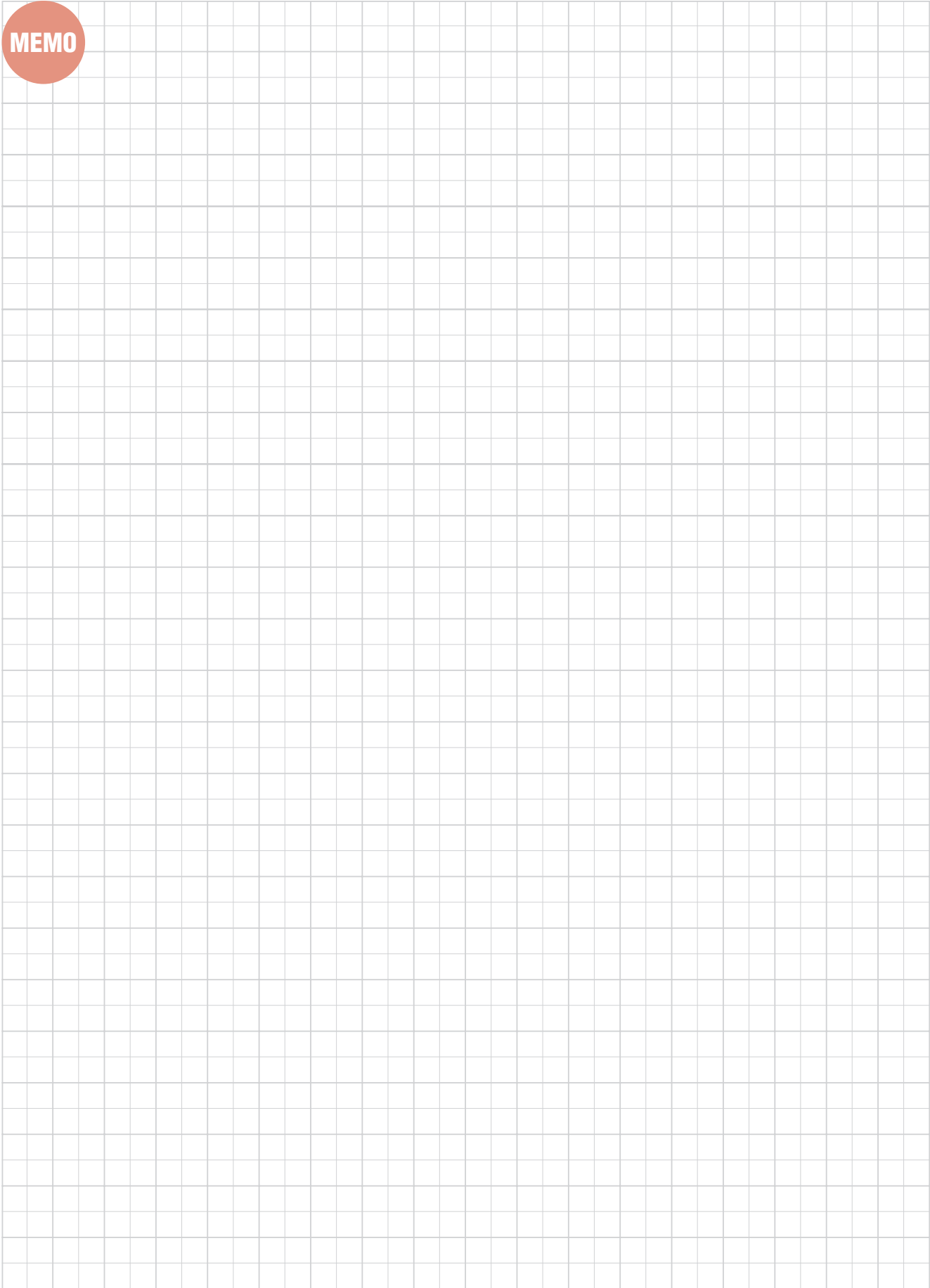

Worldwide Network



Tungaloy Corporation Head Office

11-1 Yoshima Kogyodanchi
Iwaki 970-1144 Japan
Phone: +81-246-36-8501
Fax: +81-246-36-8542
www.tungaloy.co.jp

Iwaki Plant

Products: Cutting Tools

Nagoya Plant

Products: Cutting Tools

Kyushu Plant

Products: PCBN
PCD Tools
Deep Hole Drills

Nirasaki Plant

Products: Cutting Tools
Friction Materials (TungFric)
Wear Resistant Tools
Civil Engineering Tools

Yamato Plant

Products: Cutting Tools



Tungaloy America, Inc.

3726 N Ventura Drive
Arlington Heights
IL 60004, U.S.A.
Phone: +1-888-554-8394
Fax: +1-888-554-8392
www.tungaloyamerica.com

Tungaloy Canada

432 Elgin St. Unit 3, Brantford
Ontario N3S 7P7, Canada
Phone: +1-519-758-5779
Fax: +1-519-758-5791
www.tungaloy.co.jp/ca

Tungaloy de Mexico S.A.

C Los Arellano 113
Parque Industrial Siglo XXI
Aguascalientes, AGS
Mexico 20290
Phone: +52-449-929-5410
Fax: +52-449-929-5411
www.tungaloy.co.jp/mx

Tungaloy do Brasil Ltda.

Avd. Independencia N4158
Residencial Flora, 13280-000
Vinhedo, São Paulo, Brasil
Phone: +55-19-38262757
Fax: +55-19-38262757
www.tungaloy.com/br

Tungaloy Germany GmbH

An der Alten Ziegelei 1
D-40789 Monheim, Germany
Phone: +49-2173-90420-0
Fax: +49-2173-90420-19
www.tungaloy.de

Tungaloy France S.A.S.

ZA Courtaboeuf - Le Rio
1 rue de la Terre de feu
F-91952 Courtaboeuf Cedex, France
Phone: +33-1-6486-4300
Fax: +33-1-6907-7817
www.tungaloy.fr

Tungaloy Italia S.r.l.

Via E. Andolfato 10
I-20126 Milano, Italy
Phone: +39-02-252012-1
Fax: +39-02-252012-65
www.tungaloy.it

Tungaloy Czech s.r.o

Turanka 115
CZ-627 00 Brno, Czech Republic
Phone: +420-532 123 391
Fax: +420-532 123 392
www.tungaloy.cz

Tungaloy Ibérica S.L.

C/Miquel Servet, 43B, Nau 7
Pol. Ind. Bufalvent
ES-08243 Manresa (BCN), Spain
Phone: +34 93 113 1360
Fax: +34 93 876 2798
www.tungaloy.es

Tungaloy Scandinavia AB

Bultgatan 38
442 40 Kungälv, Sweden
Phone: +46-462119200
www.tungaloy.se

Tungaloy Rus, LLC

Andropova avenue, h.18/7,
11 floor, office 3, 115432,
Moscow, Russia
Phone: +7-499-683-01-80
Fax: +7-499-683-01-81
www.tungaloy.co.jp/ru

Tungaloy East LLC

Stachek str., h.4, office 2, Ekaterinburg,
620017, RUSSIA
Phone: +7-343-389-13-22
Fax: +7-343-278-94-35
www.tungaloy.co.jp/rue

Tungaloy Polska Sp. z o.o.

ul. Genewska 24
03-963 Warszawa, Poland
Phone: +48-22-617-0890
Fax: +48-22-617-0890
www.tungaloy.co.jp/pl



Tungaloy U.K. Ltd

The Technology Centre
Wolverhampton Science Park
Glaisher Drive, Wolverhampton
West Midlands WV10 9RU, UK
Phone: +44 121 4000 231
Fax: +44 121 270 9694
www.tungaloy.co.jp/uk

Tungaloy Hungary Kft

Erzsébet királyné útja 125
H-1142 Budapest, Hungary
Phone: +36 1 781-6846
Fax: +36 1 781-6866
www.tungaloy.co.jp/hu

Tungaloy Turkey

Dudullu OSB 4. Cad No:4
34776 Ümraniye Istanbul, TURKEY
Phone: +90 216 540 04 67
Fax: +90 216 540 04 87
www.tungaloy.com.tr

Tungaloy Benelux b.v.

Tjalk 70
NL-2411 NZ Bodegraven Netherlands
Phone: +31 172 630 420
Fax: +31 172 630 429
www.tungaloy-benelux.com

Tungaloy Croatia

Josipa Kozarca 4
10432 Bregana, Croatia
Phone: +385 1 3326 604
Fax: +385 1 3327 683
www.tungaloy.hr

Tungaloy Cutting Tool (Shanghai) Co.,Ltd.

Rm No 401 No.88 Zhabei
Jiangchang No.3 Rd
Shanghai 200436, China
Phone: +86-21-3632-1880
Fax: +86-21-3621-1918
www.tungaloy.co.jp/tcts

Tungaloy Cutting Tool (Thailand) Co.,Ltd.

Interlink tower 4th Fl.
1858/5-7 Bangna-Trad Road
km.5 Bangna, Bangna, Bangkok
10260
Thailand
Phone: +66-2-751-5711
Fax: +66-2-751-5715
www.tungaloy.co.th

Tungaloy Singapore (Pte.), Ltd.

62 Ubi Road 1
#06-11 Oxley BizHub 2
Singapore 408734
Phone: +65-6391-1833
Fax: +65-6299-4557
www.tungaloy.co.jp/tspl

Tungaloy Vietnam

Unit 18
4th Fl. Saigon Centre Building
65 Le Loi Blvd.
Dist 1, Ho Chi Minh City, Vietnam
Phone: +84-8-3827-0201
Fax: +84-8-3827-0203
www.tungaloy.co.jp/tspl

Tungaloy India Pvt. Ltd.

Indiabulls Finance Centre,
Unit # 902-A, 9th Floor,
Tower 1, Senapati Bapat Marg,
Elphinstone Road (West),
Mumbai -400013, India
Phone: +91-22-6124-8804
Fax: +91-22-6124-8899
www.tungaloy.co.jp/in

Tungaloy Korea Co., Ltd

#1312, Byucksan Digital Valley 5-cha
Beotkkot-ro 244, Geumcheon-gu
153-788 Seoul, Korea
Phone: +82-2-2621-6161
Fax: +82-2-6393-8952
www.tungaloy.co.jp/kr

Tungaloy Malaysia Sdn Bhd

50 K-2, Kelana Mall, Jalan
SS6/14, Kelana Jaya, 47301
Petaling Jaya, Selangor Darul Ehsan
Malaysia
Phone: +603-7805-3222
Fax: +603-7804-8563
www.tungaloy.co.jp/my

Tungaloy Australia Pty Ltd

PO Box 2232, Rowville
Victoria 3178, Australia
Phone: +61-3-9755-8147
Fax: +61-3-9755-6070
www.tungaloy.com.au

PT. Tungaloy Indonesia

Kompleks Grand Wisata Block AA-10
No.3-5 Cibitung
Bekasi 17510, Indonesia
Phone: +62-21-8261-5808
Fax: +62-21-8261-5809
www.tungaloy.co.jp/id

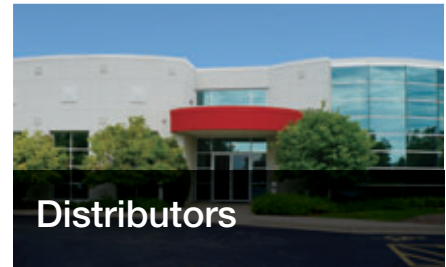

Sunrox International, INC

No. 89, Chang An W. Road
Taipei TW, Taiwan
Phone: +886-2-2555-1111
Fax: +886-2-2556-3333
www.sunroxm.com.tw

Star Tooling CC

P.O. Box 11316
Selcourt 1567
Springs, South Africa
Phone: +27 011 818-2259
Fax: +27 011 818-2250
www.startooling.co.za

Alfita Co.,Ltd

1-1318, Melezha str.
Minsk 220013, Belarus
Phone: +375296400911
Fax: +375172685054
www.mtool.by

S.C.Plastteh SRL

Str. Ioan Budai Deleanu Nr. 64
Cluj-Napoca 400474, Romania
Phone: +40 364-148940
Fax: +40 364-149956
www.tungaloy.ro



Tungaloy Corporation (Head office)

11-1 Yoshima-Kogyodanchi
Iwaki-city, Fukushima, 970-1144 Japan
Phone: +81-246-36-8501 Fax: +81-246-36-8542
www.tungaloy.co.jp

Tungaloy America, Inc.

3726 N Ventura Drive, Arlington Heights, IL 60004, U.S.A.
Phone: +1-888-554-8394 Fax: +1-888-554-8392
www.tungaloyamerica.com

Tungaloy Canada

432 Elgin St. Unit 3, Brantford, Ontario N3S 7P7, Canada
Phone: +1-519-758-5779 Fax: +1-519-758-5791
www.tungaloy.com/ca

Tungaloy de Mexico S.A.

C Los Arellano 113, Parque Industrial Siglo XXI
Aguascalientes, AGS, Mexico 20290
Phone: +52-449-929-5410 Fax: +52-449-929-5411
www.tungaloy.com/mx

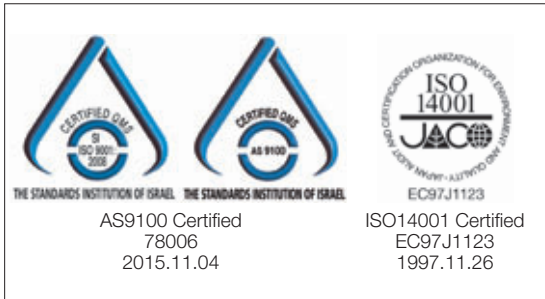

DISTRIBUTED BY: