

High depth of cut milling tool with 3 corners for perpendicularity

# Triple Mill

KORLOY  
TECH-NEWS

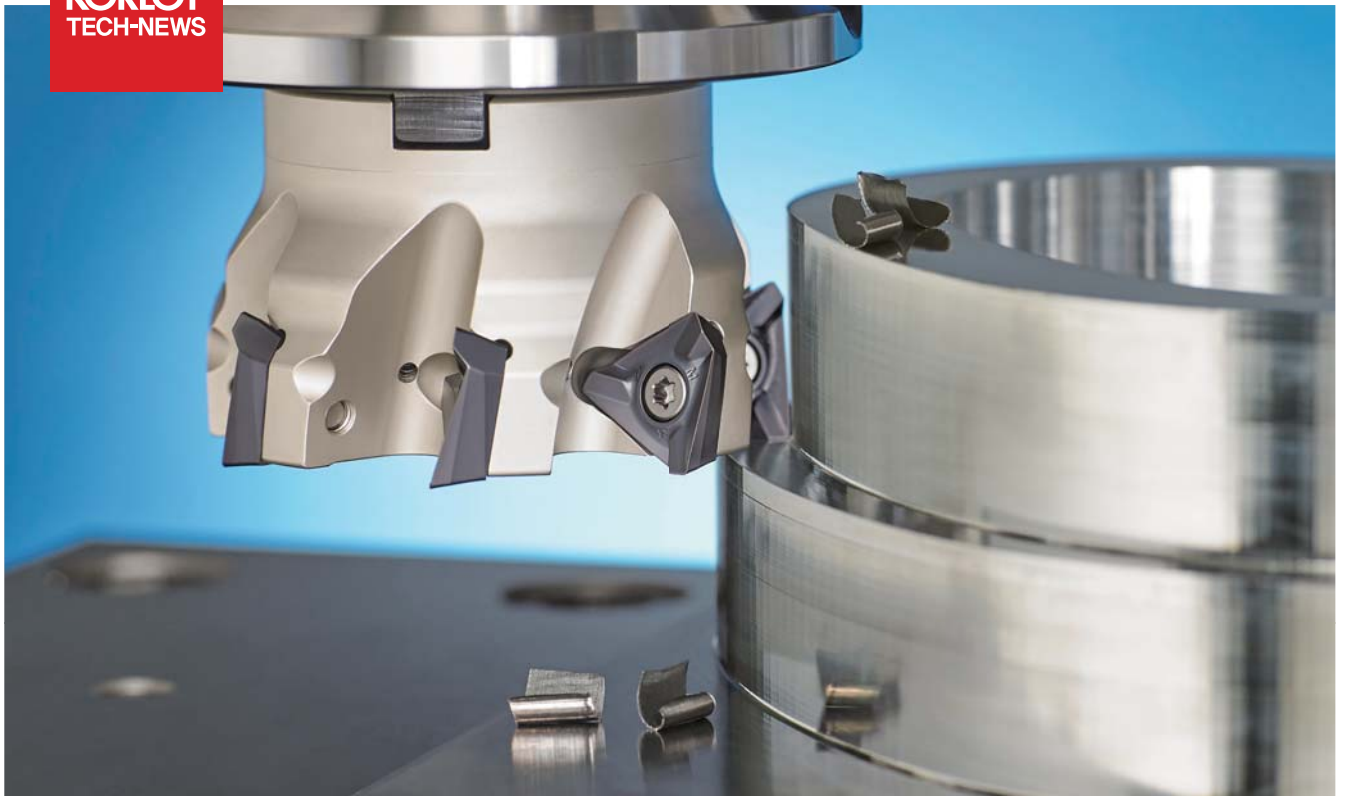

- Economical milling tool with 3 corners with positive cutting edge for high depth of cut machining
- Stable machinability in high feed machining due to enhanced chip evacuation and thicker insert
- High precision machining from less cutting load due to high helix and sharp cutting edge

High depth of cut milling tool with 3 corners for perpendicularity

# Triple Mill

Workpieces made of casting used for automobile components and large metal molds machining have uneven surface which causes chattering. Also in casting machining, tools for high depth of cut machining is needed due to its irregular depth of machining. However, it is hard to use the existing tool in high depth of cut machining because of high cutting load. In this cutting condition with interruption, impact and chattering actualize worse surface finish and fracture of tool due to lower machinability rigidity of tool.

KORLOY's newly launched Triple Mill creates the solutions for those troubles and realizing high depth of cut machining.

**Triple Mill** has applied a cutting edge with high depth of cut (Max. 15.5 mm) in single cutting with 3 corners allowing it to meet the most competitive price. In addition, the independent high rake chip breaker and high helix cutting edge reduces the cutting resistance and controls chattering in high depth of cut machining effectively. Its precise cutting edge with right angle ensures milling with high quality.

Specialized Triple Mill in high depth of cut machining and its optimized grade applied with each different cutting condition actualize excellent performance and increase customer's productivity.



## Economical tool

- High depth of cut cutting edge with 3 corners (Max. 15.5 mm)

## Enhanced machinability

- Lowered cutting load by applying high helix cutting edge and sharp chip break
- Excellent chip control due to high rake chip breaker

## High quality surface finish

- Excellent perpendicularity and surface finish from high precision cutting edge

## Stable machining

- Stable clamping structure with wide clamping side
- Thicker insert

## Application range

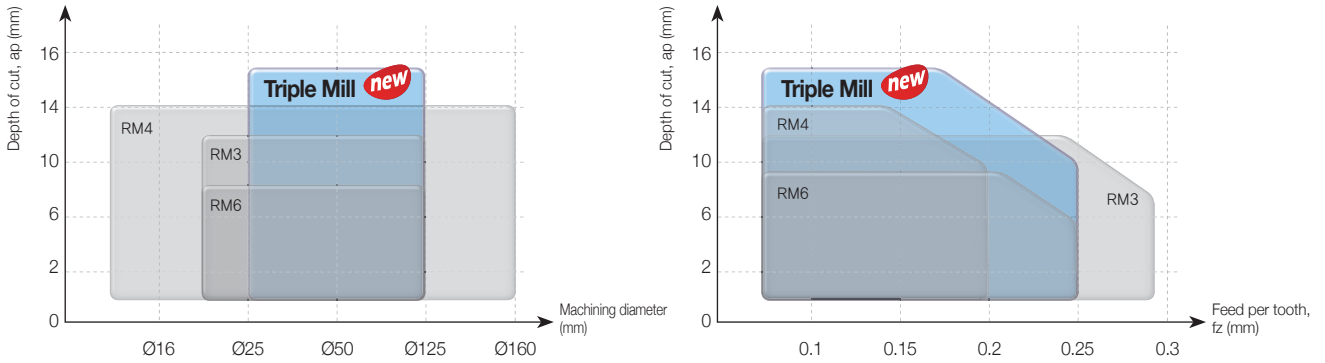

## Code system

### 【Insert】

<b>T</b>	<b>N</b>	<b>K</b>	<b>T</b>	<b>20</b>	<b>07</b>	<b>08</b>	<b>P</b>	<b>E</b>	<b>S</b>	<b>R - MM</b>
Insert shape T: T type	Relief angle N: 0°	Tolerance K: K grade	Cross section type T: T type	Cutting-edge length 20: 20 mm	Height of cutting-edge 07: 7.0 mm	Nose R 08: R0.8	Approach angle P: 90°	Relief angle of minor cutting edge E: 20°	Edge preparation S: Negative land honing E: Honing	Hand R: Right Chip breaker MM: for general cutting ML: for finishing

### 【Shank type】

<b>TPM</b>	<b>S</b>	<b>032</b>	<b>R</b>	<b>- 3</b>	<b>W</b>	<b>32 - 130 - TN11</b>
Triple Mill	Type S: Shank	Machining diameter 032: Ø32 mm	Oil hole & Hand R: With oil hole, Right-handed NR: Without oil hole, Right-handed	No. of tooth 3: 3 tooth	Shank type W: Weldon C: Cylinder	Shank dia. R 032: Ø32 mm Shank length 130: 130 mm Insert TN11: TNKT11

### 【Cutter type】

<b>TPM</b>	<b>C</b>	<b>M</b>	<b>080 - R</b>	<b>27 - 7 - TN20</b>
Triple Mill	Type C: Cutter	Arbors type M: Metric A: Inch None: Asia	Machining diameter 080: Ø80 mm Oil hole & Hand R: With oil hole, Right-handed NR: Without oil hole, Right-handed	Internal 27: 27 mm No. of tooth 7: 7 tooth Insert TN20: TNKT20

## Insert features

- Economical insert with 3 corners due to high depth of cut cutting edge
- Lowered cutting load and enhanced chip evacuation by sharp chip breaker and high helix cutting edge
- Stable machinability even in high cutting conditions from high rigidity design

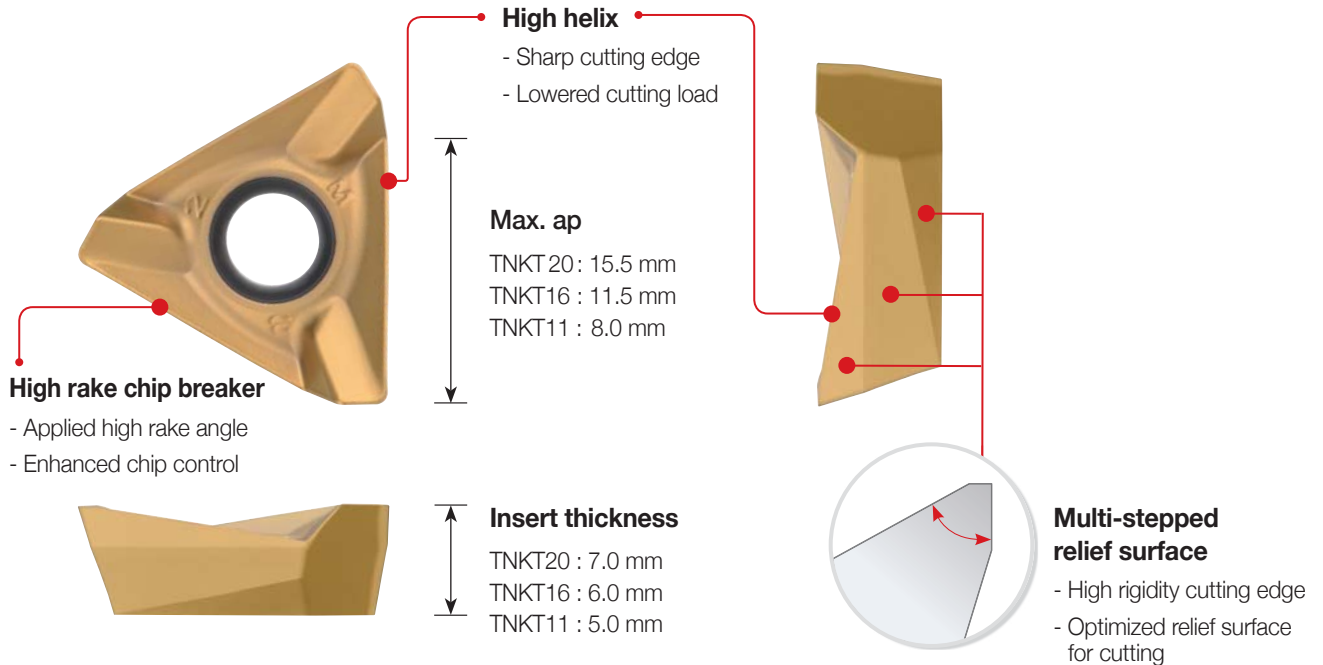

## Cutter features

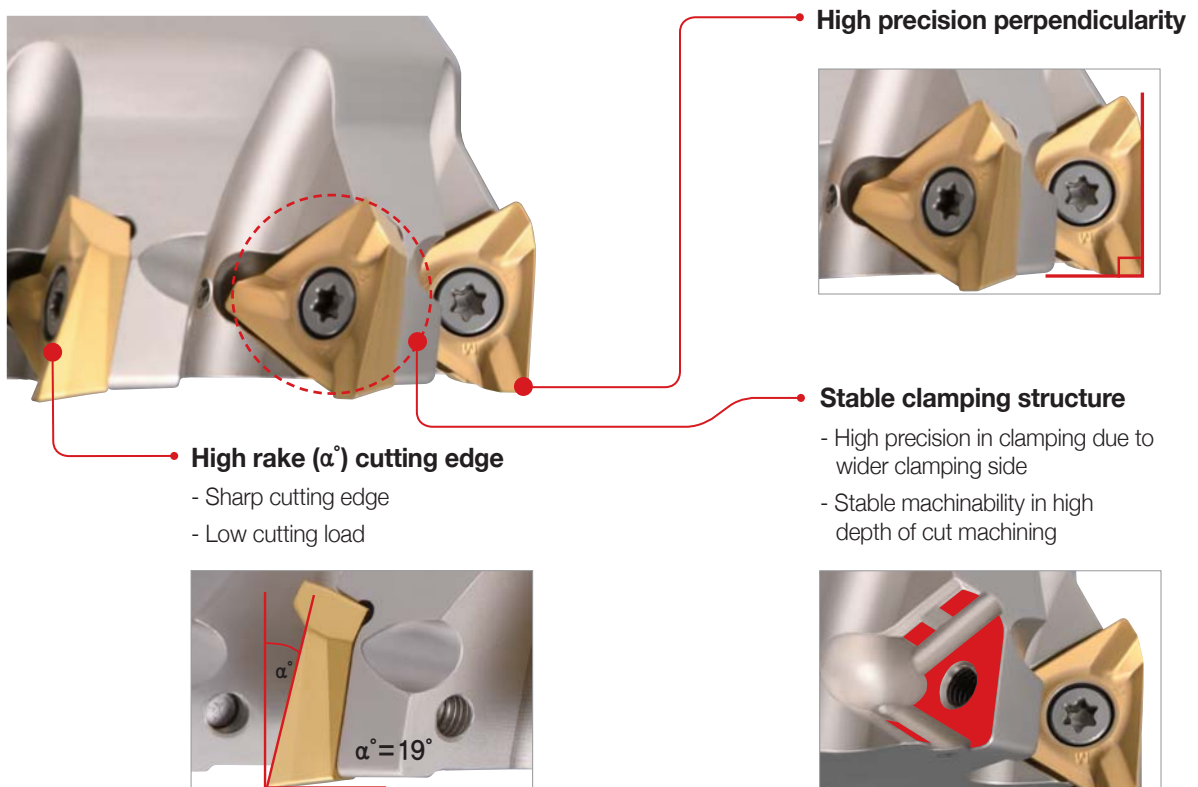

# Performance evaluation

## Perpendicularity

- **Workpiece** Alloy steel (SCM440, HB200), 300(L)x200(W)x100(H)
- **Cutting conditions** vc (m/min) = 200, fz (mm/t) = 0.2, ap (mm) = 12 mm x 2 Passes (Total 24 mm), ae (mm) = 5, dry
- **Tools** **Insert** TNKT200708PESR-MM (PC5300) **Holder** TPMCM080R-27-7-TN20

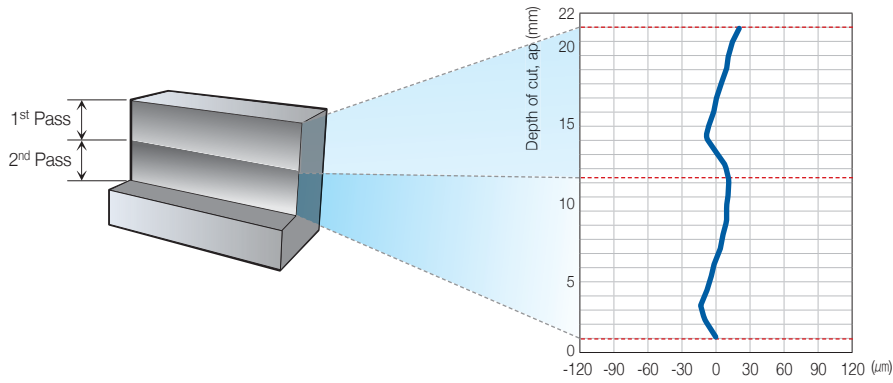

▶ Perpendicularity error is less than 40 μm.

[Graph of measured perpendicularities]

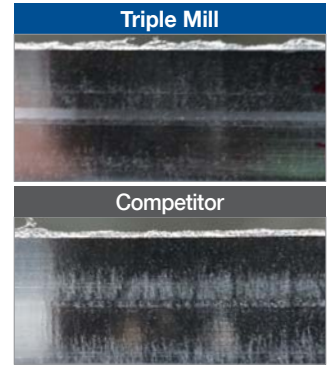

[Comparison picture of flank surface finish]

## Wear resistance

- **Workpiece** Alloy steel (SCM440, HB200), 300(L)x200(W)x100(H)
- **Cutting conditions** vc (m/min) = 200, fz (mm/t) = 0.2, ap (mm) = 7, ae (mm) = 10, dry
- **Tools** **Insert** TNKT160608PESR-MM (PC5300) **Holder** TPMCM063R-22-6-TN16



[Triple Mill]

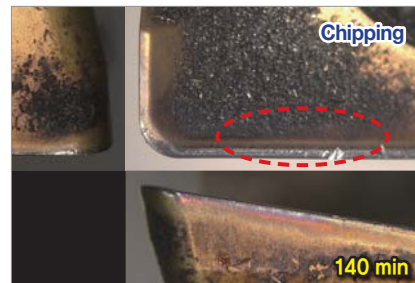

[Competitor]

## Surface finish

- **Workpiece** Alloy steel (SCM440, HB200), 300(L)x200(W)x100(H)
- **Cutting conditions** vc (m/min) = 200, fz (mm/t) = 0.2, ap (mm) = 7, ae (mm) = 10, dry
- **Tools** **Insert** TNKT160608PESR-MM (PC5300) **Holder** TPMCM063R-22-6-TN16

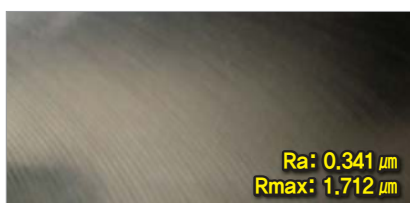

[Triple Mill]



[Competitor]

# Perpendicularity tool selection guide

— Triple Mill    — RM3    — RM4    — RM6



## Triple Mill <sup>new</sup>

- Low cutting load
- Maximum depth of cut



## RM3

- Stable clamping
- Complete price



## RM4

- For general machining

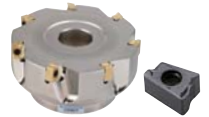

## RM6



- Maximum no. of corners
- Enhanced surface finish



Tools	Cutting load	Maximum depth of cut	Cost	Stable clamping	Perpendicularity	No. of corners
Triple Mill <sup>new</sup>	★★★★★	★★★★★	★★★	★★★	★★★	★★
RM3	★★★	★★	★★★★★	★★★★★	★★★	★★
RM4	★★★	★★★	★★★	★★★	★★★	★★★
RM6	★★★	★★★	★★	★★★	★★★★★	★★★★★

## Recommended grade and chip breaker

(● : 1<sup>st</sup> Recommendation)



C/B	Cutting edge	P		M		K		N		S			
		Low carbon steel/ Mild steel		High carbon steel/ Alloy steel		Stainless steel		Cast iron		Non-ferrous metal		HRSA	
		C/B	Grade	C/B	Grade	C/B	Grade	C/B	Grade	C/B	Grade	C/B	Grade
ML		-	● PC3700 ○ PC5300 ○ PC5400	-	● PC3700 ○ PC5300 ○ PC5400	●	● PC5300 ○ PC5400 ○ PC9540	-	● PC6510 ○ PC5300 ○ PC5400	-	-	●	● UPC845 ○ UNC840 ○ PC5300 ○ PC5400
MM		●	● PC3700 ○ PC5300 ○ PC5400	●	● PC3700 ○ PC5300 ○ PC5400	-	● PC5300 ○ PC5400 ○ PC9540	●	● PC6510 ○ PC5300 ○ PC5400	-	-	-	● UPC845 ○ UNC840 ○ PC5300 ○ PC5400

## Recommended cutting condition

Workpiece	Grade	Cutting speed vc (m/min)	TNKT11		TNKT16		TNKT20	
			fz (mm/t)	Max. ap (mm)	fz (mm/t)	Max. ap (mm)	fz (mm/t)	Max. ap (mm)
P Steel	PC3700	160-270	0.25-0.1	8.0	0.25-0.1	11.5	0.25-0.1	15.5
	PC5300	140-240	0.25-0.1	8.0	0.25-0.1	11.5	0.25-0.1	15.5
M Stainless steel	PC5300	90-150	0.2-0.05	8.0	0.2-0.05	11.5	0.2-0.05	15.5
	PC5400	70-120	0.2-0.05	8.0	0.2-0.05	11.5	0.2-0.05	15.5
	PC9540	70-120	0.2-0.05	8.0	0.2-0.05	11.5	0.2-0.05	15.5
K Cast iron	PC6510	150-250	0.3-0.1	8.0	0.3-0.10	11.5	0.3-0.1	15.5
S HRSA	PC5300	20-50	0.15-0.05	8.0	0.15-0.05	11.5	0.15-0.05	15.5
	UPC845	30-50	0.15-0.05	8.0	0.15-0.05	11.5	0.15-0.05	15.5
	UNC840	20-40	0.15-0.05	8.0	0.15-0.05	11.5	0.15-0.05	15.5

※ The above data refer to general cutting conditions and can be adjustable to the speed of 350 m/min and the feed per tooth of 0.3 mm/t depending on user environment.

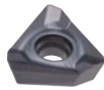
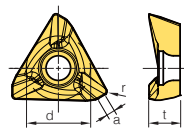
## Insert

Inserts	Designation	Coated						Dimensions (mm)				Geometries
		PC3700	PC6510	PC9540	PC5300	PC5400	UNC840	UPC845	d	t	r	
	TNKT 110508PEER-ML	●			●			8.0	4.500	0.8	1.3	
	160608PEER-ML	●			●			11.7	5.500	0.8	1.5	
	200708PEER-ML	●			●			14.5	7.000	0.8	2.0	
	TNKT 110508PESR-MM	●			●			8.0	4.531	0.8	1.3	
	160608PESR-MM	●			●			11.7	5.531	0.8	1.5	
	200708PESR-MM	●			●			14.5	7.031	0.8	2.0	

● : Stock item



# TPMCM-TN16



• AR: 10°  
• RR: -11°~-13.5°

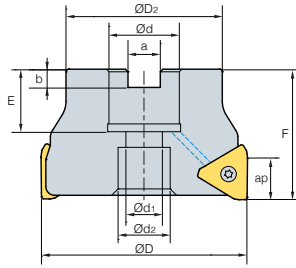

Fig. 1

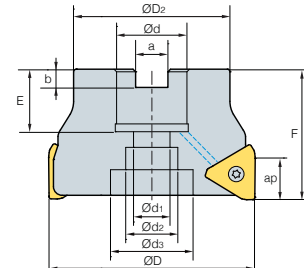

Fig. 2

(mm)

Designation	Stock	⊙	ØD	ØD2	Ød	Ød1	Ød2	Ød3	a	b	E	F	ap	kg	Available insert	Fig.
TPMCM 050R-22-4-TN16			50	42	22	11	18	-	10.4	6.3	21	40	11.5	0.26	TNKT16	1
050R-22-5-TN16	●		50	42	22	11	18	-	10.4	6.3	21	40	11.5	0.26		1
063R-22-4-TN16			63	50	22	11	18	-	10.4	6.3	21	40	11.5	0.50		1
063R-22-6-TN16	●		63	50	22	11	18	-	10.4	6.3	21	40	11.5	0.48		1
080R-27-6-TN16			80	60	27	14	20	-	12.4	7	24	50	11.5	0.99		1
080R-27-8-TN16	●		80	60	27	14	20	-	12.4	7	24	50	11.5	0.99		1
100R-32-8-TN16			100	70	32	18	28	45	14.4	8	28	63	11.5	1.85		2
100R-32-10-TN16	●		100	70	32	18	28	45	14.4	8	28	63	11.5	1.83		2
125R-40-12-TN16			125	90	40	22	32	54	16.4	9	30	63	11.5	3.12		2
125R-40-14-TN16	●		125	90	40	22	32	54	16.4	9	30	63	11.5	3.10		2

●: Stock item

## Available inserts

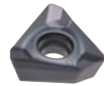

TNKT-ML



TNKT-MM

Designation	Coated						
	PC3700	PC6510	PC9540	PC5300	PC5400	UNC840	UPC845
TNKT 160608PEER-ML	●			●			
160608PESR-MM	●			●			

●: Stock item

## Available arbors

Designation	Ød	Available arbors
TPMCM 050R-22-□-TN□□	22	BT□□-FMC22-□□
063R-22-□-TN□□		
080R-27-□-TN□□	27	BT□□-FMC27-□□
100R-32-□-TN□□	32	BT□□-FMC32-□□
125R-40-□-TN□□	40	BT□□-FMC40-□□

## Parts

Specification	Parts	Screw	Wrench
Ø50~Ø125		FTKA0410	TW15S



# TPMCM-TN20



• AR: 10°  
• RR: -10.5°~-14°

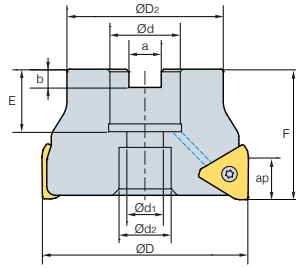

Fig. 1

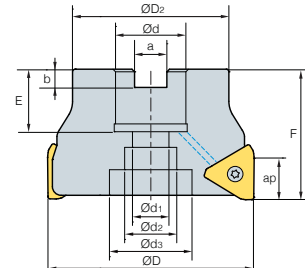

Fig. 2

(mm)

Designation	Stock	⊙	ØD	ØD2	Ød	Ød1	Ød2	Ød3	a	b	E	F	ap	kg	Available insert	Fig.
TPMCM 063R-22-5-TN20	●	5	63	50	22	11	18	-	10.4	6.3	21	50	15.5	0.57	TNKT20	1
063R-22-6-TN20	●	6	63	50	22	11	18	-	10.4	6.3	21	50	15.5	0.58		1
080R-27-5-TN20	●	5	80	60	27	14	20	-	12.4	7	24	50	15.5	0.92		1
080R-27-7-TN20	●	7	80	60	27	14	20	-	12.4	7	24	50	15.5	0.86		1
100R-32-7-TN20	●	7	100	70	32	18	28	45	14.4	8	28	63	15.5	1.79		2
100R-32-9-TN20	●	9	100	70	32	18	28	45	14.4	8	28	63	15.5	1.68		2
125R-40-8-TN20		8	125	90	40	22	32	52	16.4	9	30	63	15.5	3.08		2
125R-40-11-TN20		11	125	90	40	22	32	52	16.4	9	30	63	15.5	2.99		2

●: Stock item

## Available inserts

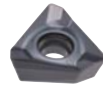

TNKT-ML



TNKT-MM

Designation	Coated						
	PC3700	PC6510	PC9540	PC5300	PC5400	UNC840	UPC845
TNKT 200708PEER-ML	●			●			
200708PESR-MM	●			●			

●: Stock item

## Available arbors

Designation	Ød	Available arbors
TPMCM 063R-22-□-TN□□	22	BT□□-FMC22-□□
080R-27-□-TN□□	27	BT□□-FMC27-□□
100R-32-□-TN□□	32	BT□□-FMC32-□□
125R-40-□-TN□□	40	BT□□-FMC40-□□

## Parts

Specification	Parts	Screw	Wrench
Ø63~Ø125		FTGA0511-P	TW20-100

# TPMS-TN11

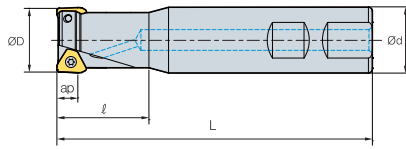

Fig. 1

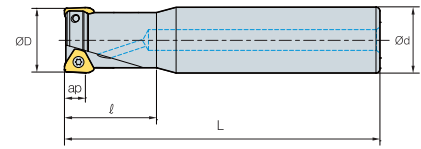

Fig. 2



AA  
90°  
• AR: 8°~10°  
• RR: -14°~-15°

(mm)

	Designation	Stock		$\varnothing D$	$\varnothing d$	$\ell$	L	ap		Available insert	Fig.
TPMS	025R-2W25-120-TN11		2	25	25	35	120	8.0	0.37	TNKT11	1
	025R-2C25-200-TN11		2	25	25	35	200	8.0	0.65		2
	025R-3W25-120-TN11	●	3	25	25	35	120	8.0	0.36		1
	025R-3C25-200-TN11	●	3	25	25	35	200	8.0	0.64		2
	032R-2W32-130-TN11		2	32	32	40	130	8.0	0.71		1
	032R-2C32-200-TN11		2	32	32	40	200	8.0	1.12		2
	032R-3W32-130-TN11		3	32	32	40	130	8.0	0.70		1
	032R-3C32-200-TN11		3	32	32	40	200	8.0	1.14		2
	032R-4W32-130-TN11	●	4	32	32	40	130	8.0	0.70		1
	032R-4C32-200-TN11	●	4	32	32	40	200	8.0	1.11		2
	040R-4W40-130-TN11		4	40	40	40	130	8.0	1.12		1
	040R-5W40-130-TN11	●	5	40	40	40	130	8.0	1.11		1

●: Stock item

## Available inserts

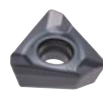

TNKT-ML



TNKT-MM

Designation	Coated						
	PC3700	PC6510	PC9540	PC5300	PC5400	UNC840	UPC845
TNKT 110508PEER-ML	●			●			
110508PESR-MM	●			●			

●: Stock item

## Parts

Specification	Parts	Screw	Wrench
	$\varnothing 25\text{--}\varnothing 40$		 FTKA0307

# TPMS-TN16

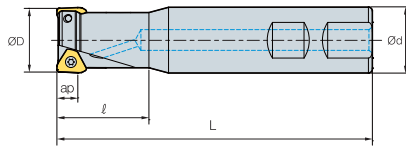

Fig. 1

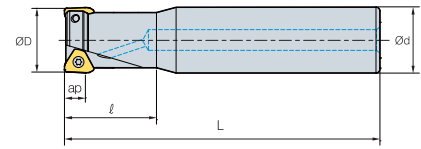

Fig. 2



AA  
90°  
• AR: 10°  
• RR: -13.5°

(mm)

	Designation	Stock		ØD	Ød	l	L	ap		Available insert	Fig.
TPMS	032R-2W32-130-TN16	●	2	32	32	40	130	11.5	0.68	TNKT16	1
	032R-2C32-200-TN16		2	32	32	40	200	11.5	1.10		2
	040R-3W40-130-TN16		3	40	40	40	130	11.5	1.09		1
	040R-3C40-200-TN16		3	40	40	40	200	11.5	1.75		2
	040R-4W40-130-TN16	●	4	40	40	40	130	11.5	1.08		1

●: Stock item

## Available inserts

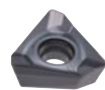

TNKT-ML



TNKT-MM

Designation	Coated						
	PC3700	PC6510	PC9540	PC5300	PC5400	UNC840	UPC845
TNKT 160608PEER-ML	●			●			
160608PESR-MM	●			●			

●: Stock item

## Parts

Specification	Parts	Screw	Wrench
	Ø32-Ø40		
		FTKA0410	TW15S

***www.korloy.com***



Holystar B/D, 1350, Nambusunhwan-ro, Geumcheon-gu, Seoul, 08536, Korea  
Tel : +82-2-522-3181 Fax : +82-2-522-3184, +82-2-3474-4744 Web : www.korloy.com E-mail : sales.khq@korloy.com

#### **KORLOY AMERICA**

620 Maple Avenue, Torrance, CA 90503, USA  
Tel : +1-310-782-3800 Toll Free : +1-888-711-0001 Fax : +1-310-782-3885  
E-mail : sales.kai@korloy.com

#### **KORLOY INDIA**

Plot No. 415, Sector 8, IMT Manesar, Gurgaon 122051, Haryana, India  
Tel : +91-124-4391790 Fax : +91-124-4050032  
E-mail : sales.kip@korloy.com

#### **KORLOY TURKEY**

Orucreis Mah. Vadi Cad. No: 108 Istanbul Ticaret Sarayi  
Kat 5 No: 318 Giyimkent Sitesi-Esenler/Istanbul, Turkey  
Tel : +90-212-438-5197 E-mail : sales.ktl@korloy.com

#### **KORLOY RUSSIA**

Krasivy Dom office No. 305, Bld. 5, Novovladykinskiy proezd 8, 127106,  
Moscow, Russia  
Tel : +7-495-280-1458 Fax : +7-495-280-1459 E-mail : sales.krc@korloy.com

#### **KORLOY FACTORY QINGDAO**

Ground Dongjing Road 56(B) District Free Trade Zone. Qingdao, China  
Tel : +86-532-86959880 Fax : +86-532-86760651  
E-mail : pro.kfq@korloy.com

#### **KORLOY EUROPE**

Gablونzer Str. 25-27, 61440 Oberursel, Germany  
Tel : +49-6171-277-83-0 Fax : +49-6171-277-83-59  
E-mail : sales.keg@korloy.com

#### **KORLOY BRASIL**

Av. Aruana 280, conj.12, WLC, Alphaville, Barueri,  
CEP06460-010, SP, Brasil  
Tel : +55-11-4193-3810 E-mail : sales.kbl@korloy.com

#### **KORLOY CHILE**

Av. Providencia 1650, Office 1009, 7500027  
Providencia-Santiago, Chile  
Tel : +56-229-295-490 E-mail : sales.kcs@korloy.com

#### **KORLOY MEXICO**

Queretaro, Mexico  
E-mail : sales.kml@korloy.com

#### **KORLOY FACTORY INDIA**

Plot No. 415, Sector 8, IMT Manesar, Gurgaon 122051, Haryana, India  
Tel : +91-124-4391790 Fax : +91-124-4050032  
E-mail : pro.kim@korloy.com